



VFD-VJ

User Manual

Delta's high-performance Hybrid servo drive



Power Range :

3-phase 230V series: 5.5kW~37kW (7.5~50HP)
3-phase 460V series: 5.5kW~75kW (7.5~100HP)



IABU Headquarters

Delta Electronics, Inc.
Taoyuan Technology Center
No.18, Xinglong Rd., Taoyuan City,
Taoyuan County 33068, Taiwan
TEL: 886-3-362-6301 / FAX: 886-3-371-6301

Asia

Delta Electronics (Jiangsu) Ltd.
Wujiang Plant 3
1688 Jiangxing East Road,
Wujiang Economic Development Zone
Wujiang City, Jiang Su Province,
People's Republic of China (Post code: 215200)
TEL: 86-512-6340-3008 / FAX: 86-769-6340-7290

Delta Greentech (China) Co., Ltd.
238 Min-Xia Road, Pudong District,
Shanghai, P.R.C.
Post code : 201209
TEL: 86-21-58635678 / FAX: 86-21-58630003

Delta Electronics (Japan), Inc.
Tokyo Office
2-1-14 Minato-ku Shibadaimon,
Tokyo 105-0012, Japan
TEL: 81-3-5733-1111 / FAX: 81-3-5733-1211

Delta Electronics (Korea), Inc.
1511, Byucksan Digital Valley 6-cha, Gasan-dong,
Geumcheon-gu, Seoul, Korea, 153-704
TEL: 82-2-515-5303 / FAX: 82-2-515-5302

Delta Electronics Int'l (S) Pte Ltd
4 Kaki Bukit Ave 1, #05-05, Singapore 417939
TEL: 65-6747-5155 / FAX: 65-6744-9228

Delta Electronics (India) Pvt. Ltd.
Plot No 43 Sector 35, HSIIDC
Gurgaon, PIN 122001, Haryana, India
TEL : 91-124-4874900 / FAX : 91-124-4874945

Americas

Delta Products Corporation (USA)
Raleigh Office
P.O. Box 12173, 5101 Davis Drive,
Research Triangle Park, NC 27709, U.S.A.
TEL: 1-919-767-3800 / FAX: 1-919-767-8080

Delta Greentech (Brasil) S.A
Sao Paulo Office
Rua Itapeva, 26 - 3º andar Edificio Itapeva One-Bela Vista
01332-000-São Paulo-SP-Brazil
TEL: +55 11 3568-3855 / FAX: +55 11 3568-3865

Europe

Deltronics (The Netherlands) B.V.
Eindhoven Office
De Witbogt 15, 5652 AG Eindhoven, The Netherlands
TEL: 31-40-2592850 / FAX: 31-40-2592851

*We reserve the right to change the information in this catalogue without prior notice.





VFD-VJ

User Manual

Delta's high-performance Hybrid servo drive

Preface

Thank you for choosing Delta's high-performance Hybrid servo drive VFD-VJ Series dedicated to plastic injection molding machine. The VFD-VJ series products are made of high quality components and materials that incorporate the latest microcontroller technology.

This manual is to be used for the installation, parameter setting, troubleshooting, and daily maintenance of the Hybrid servo drive. To guarantee safe operation of the equipment, read the following safety guidelines before connecting power to the Hybrid servo drive. Keep this operating manual at hand and distribute to all users for reference.

To ensure the safety of operators and equipment, only qualified personnel familiar with Hybrid servo drive are to do installation, start-up and maintenance. Always read this manual thoroughly before using VFD-VJ series Hybrid Servo Drive, especially the WARNING, DANGER and CAUTION notes. Failure to comply may result in personal injury and equipment damage. If you have any questions, please contact your dealer.

Firmware version: V2.05

PLEASE READ PRIOR TO INSTALLATION FOR SAFETY.



- ☑ AC input power must be disconnected before any wiring to the Hybrid servo drive is made.
 - ☑ Even if the power has been turned off, a charge may still remain in the DC-link capacitors with hazardous voltages before the POWER LED is OFF. Please do not touch the internal circuit and components. For safe maintenance, use a multimeter to measure the voltage across the +1 and – terminals. The measured value should be lower than 25Vdc for the system to operate normally.
 - ☑ There are highly sensitive MOS components on the printed circuit boards. These components are especially sensitive to static electricity. Please do not touch these components or the circuit boards before taking anti-static measures. Never reassemble internal components or wiring.
 - ☑ Ground the Hybrid servo drive using the ground terminal. The grounding method must comply with the laws of the country where the AC motor drive is to be installed.
 - ☑ This series of products is used to control the three-phase induction motors and permanent magnet synchronous motors. It cannot be used for single-phase motors or for other purposes.
 - ☑ This series of products cannot be used on occasions that may endanger personal safety.
 - ☑ Please prevent children or unauthorized personnel from approaching the Hybrid servo drive.
-



- ☑ Never connect the Hybrid servo drive output terminals U/T1, V/T2 and W/T3 directly to the AC mains circuit power supply.
- ☑ DO NOT use Hi-pot test for internal components. The semi-conductor used in Hybrid servo drive easily damage by high-voltage.
- ☑ Even if the 3-phase AC motor is stop, a charge may still remain in the main circuit terminals of the AC motor drive with hazardous voltages.
- ☑ Only qualified persons are allowed to install, wire and maintain AC motor drives.
- ☑ When the Hybrid servo drive uses an external terminal as its source of operation commands, the motor may start running immediately after the power is supplied. In this case, it may be dangerous to any on-site personnel.



- ☑ DO NOT install the Hybrid servo drive in a place subjected to high temperature, direct sunlight, high humidity, excessive vibration, corrosive gases or liquids, or airborne dust or metallic particles.
- ☑ Only use Hybrid servo drives within specification. Failure to comply may result in fire, explosion or electric shock.
- ☑ When the motor cable between Hybrid servo drive and motor is too long, the layer insulation of the motor may be damaged. Please add an AC output reactor to prevent damage to the motor. Refer to appendix A Reactor for details.
- ☑ The rated voltage for Hybrid servo drive must be $\leq 240V$ ($\leq 480V$ for 460V models) and the mains supply current capacity must be $\leq 5000A$ RMS ($\leq 10000A$ RMS for the $\geq 40hp$ (30kW) models).



- The content of this manual may be revised without prior notice. Please consult our distributors or download the most updated version at <http://www.delta.com.tw/industrialautomation>

Table of Contents

1. Use and Installation	
1-1 Receiving and Inspection	1-2
1-2 Product Specifications.....	1-3
1-3 Selection of Hybrid Servo Drives and Motors	1-4
1-4 Product Installation.....	1-6
1-5 Product Dimensions	1-11
2. Wiring	
2-1 Description of Wiring.....	2-2
2-2 Description of Terminals on Main Circuit.....	2-7
2-3 Description of Terminals on Control Circuit.....	2-11
3. Machine Adjustment Procedure	
3-1 Description of Control Panel	3-2
3-2 Machine Adjustment Procedure	3-4
4. Description of Parameters	
4-1 Summary of Parameters.....	4-2
4-2 Detailed Description of Parameters	4-9
5. Fault Diagnostic Methods	
5-1 Error Messages.....	5-2
5-2 Over Current OC.....	5-7
5-3 Ground Fault Factor GFF	5-7
5-4 Over Voltage OV.....	5-8
5-5 Low Voltage Lv.....	5-8
5-6 Over Heat OH1.....	5-9
5-7 Overload OL.....	5-9
5-8 Phase Loss PHL.....	5-10
5-9 Electromagnetic/Induction Noise.....	5-11
5-10 Environmental Condition.....	5-12
6. <i>Suggestions and Error Corrections for Hybrid Servo Drives</i>	
6-1 <i>Maintenance and Inspections</i>	6-2

6-2 Greasy Dirt Problem.....	6-2
6-3 Fiber Dust Problem.....	6-5
6-4 Erosion Problem.....	6-6
6-5 Industrial Dust Problem.....	6-7
6-6 Wiring and Installation Problem.....	6-8
6-7 Multi-function Input/Output Terminals Problem.....	6-9

Appendix A Optional Accessories

A-1 Braking Resistor Selection Chart.....	A-2
A-2 Non-fuse Circuit Breaker.....	A-6
A-3 Fuse Specification	
A-4 Reactor.....	A-7
A-4-1 AC Input Reactor Recommended Value.....	A-7
A-4-2 AC Output Reactor Recommended Value	
A-4-3 Zero Phase Reactor	A-9
A-4-4 DC Reactor.....	A-10
A-5 Digital Keypad KPV-CE01.....	A-11
A-6 Speed Feedback PG Card Selection.....	A-15
A-7 Communication Card.....	A-19
A-8 EMI Filter.....	A-20

1. Description of Hybrid Servo Drives

1-1 Receiving and Inspection

1-2 Product Specifications

1-3 Overview of Hybrid Servo Systems

1-4 Product Installation

1-5 Product Dimensions

The Hybrid servo drive should be kept in the shipping carton or crate before installation. In order to retain the warranty coverage, the Hybrid servo drive should be stored properly when it is not to be used for an extended period of time. Storage conditions are:



CAUTION

- Store in a clean and dry location free from direct sunlight or corrosive fumes.
- Store within an ambient temperature range of -20°C to $+60^{\circ}\text{C}$.
- Store within a relative humidity range of 0% to 90% and non-condensing environment.
- Avoid storing the product in an environment containing corrosive gases and liquids.
- DO NOT place on the ground directly. It should be stored properly. Moreover, if the surrounding environment is humid, you should put exsiccator in the package.
- DO NOT store in an area with rapid changes in temperature. It may cause condensation and frost.
- If the Hybrid servo drive is stored for more than 3 months, the temperature should not be higher than 30°C . Storage longer than one year is not recommended, it could result in the degradation of the electrolytic capacitors.
- When the Hybrid servo drive is not used for longer time after installation on building sites or places with humidity and dust, it's best to move the Hybrid servo drive to an environment as stated above.

1-1 Receiving and Inspection

This VFD-VJ Hybrid servo drive has gone through rigorous quality control tests at the factory before shipment. After receiving the Hybrid servo drive, please check for the following:

- ☑ Inspect the unit to assure it was not damaged during shipment.
- ☑ Make sure that the part number indicated on the nameplate corresponds with the part number of your order.

If the registered information does not match your purchase order, or if the product has any problem, please contact the dealer or distributor.

Nameplate Information

Let us take the 15HP/11kW 230V 3-Phase model as an example.

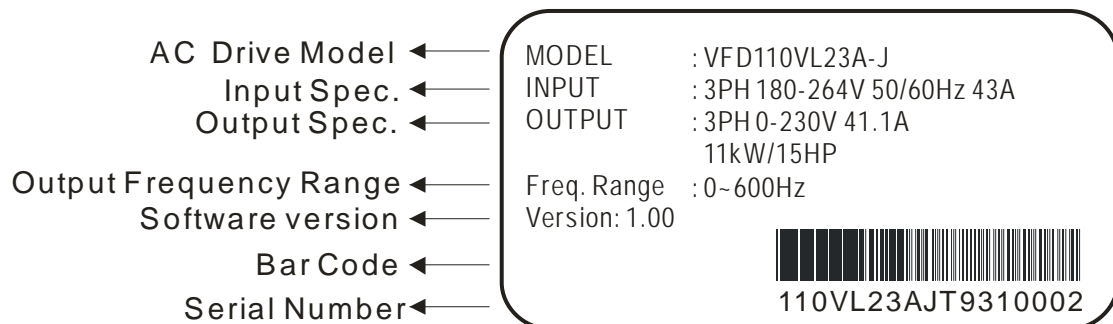

Model Explanation

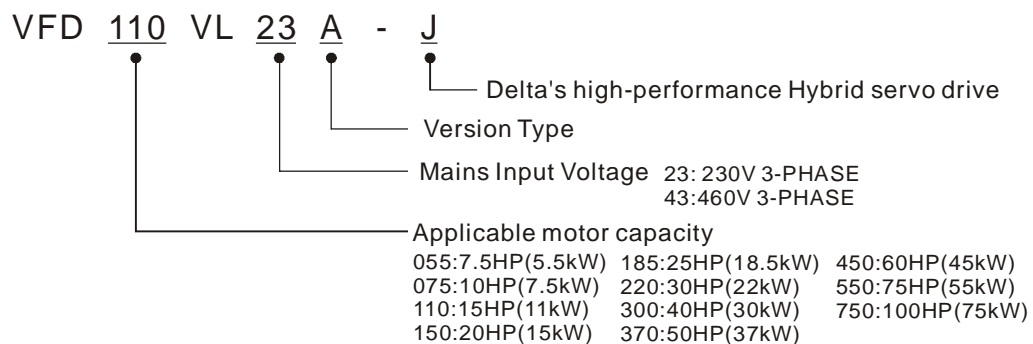

Series Number Explanation

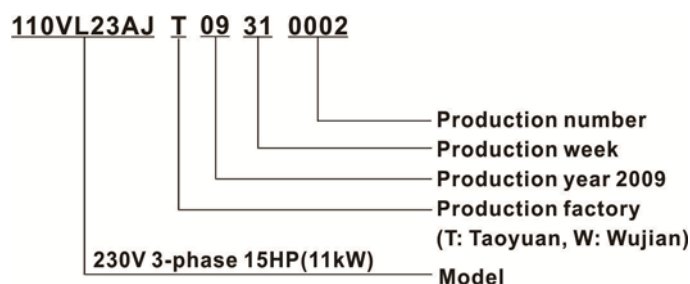

1-2 Product Specifications

Specifications of 230V Series

Frame		C			D			E2		
Model: VFD-__VL23A-J		055	075	110	150	185	220	300	370	
Power (KW)		5.5	7.5	11	15	18.5	22	30	37	
Horse Power (HP)		7.5	10	15	20	25	30	40	50	
Output	Output Current for Continuous Operation Over 60 sec (A)	33	46	62	90	119	119	180	248	
	Output Current for Continuous Operation Over 20 sec (A)	37	54	70	106	140	134	204	292	
Power	Input Current (A)	23	30	47	56	73	90	120	146	
	Tolerable Input Voltage Variation	Three-phase 200~240V 50/60Hz								
Supply	Tolerable Supply Voltage Variation	±10% (180~264V)								
	Tolerable Supply Frequency Variation	±5% (47~63Hz)								
Weight (kg)		8	10	10	13	13	13	36	36	

Specifications of 460V Series

Frame		C					D			
Model: VFD-__VL43A-J		55 A	75 A	110 A	150 B	185 B	150 A	185 A	220 A	
Power (KW)		5.5	7.5	11	15	18.5	15	18.5	22	
Horse Power (HP)		7.5	10	15	20	25	20	25	30	
Output	Output Current for Continuous Operation Over 60 sec (A)	21	27	36	46	58	46	58	62	
	Output Current for Continuous Operation Over 20 sec (A)	25	32	42	54	68	54	68	78	
Power	Input Current (A)	14	17	24	30	37	30	37	47	
	Tolerable Input Voltage Variation	Three-phase 380~480V, 50/60Hz								
Supply	Tolerable Supply Voltage Variation	±10% (342~528V)								
	Tolerable Supply Frequency Variation	±5% (47~63Hz)								
Weight (kg)		8	10	10	10	10	13	13	13	

Frame		D	E0	E1			E3	E2		
Model: VFD-__VL43A-J		300 B	370 B	300 A	370 A	450 A	450 B	550 A	750 A	
Power (KW)		30	37	30	37	45	45	55	75	
Horse Power (HP)		40	50	40	50	60	60	75	100	
Output	Output Current for Continuous Operation Over 60 sec (A)	102	124	102	124	155	155	187	255	
	Output Current for Continuous Operation Over 20 sec (A)	120	146	120	146	182	182	220	300	
Power	Input Current (A)	60	73	60	73	91	91	110	150	
	Tolerable Input Voltage Variation	Three-phase 380~480V, 50/60Hz								
Supply	Tolerable Supply Voltage Variation	±10% (342~528V)								
	Tolerable Supply Frequency Variation	±5% (47~63Hz)								
Weight (kg)		13	36	36	36	36	36	50	50	

Common Features

Control method		SVPWM
Speed Detector		Resolver / Incremental Encoder
Speed Command Input		DC 0~10V, 3-point calibration of analog input is supported
Pressure Command Input		DC 0~10V, 3-point calibration of analog input is supported
Pressure Feedback Input		The voltage is 0~10V and the current is 4~20mA. (To use new parameters, firmware v2.04 and the new I/O board are required. See Pr03-12 for more information)
Multi-function input terminal		5 ch DC24V 8mA
Multi-function output terminal		2 ch DC24V 50mA, 1 ch Relay output
Analog Output Voltage		1 ch dc 0~10V
Optional Peripheral Accessories	Speed Feedback PG Card	Mandatory (Refer to Appendix A-5)
	Braking Resistor	Mandatory (Refer to Appendix A-1)
	Pressure Sensor	Mandatory (To match the setting at Pr03-12, the setting range of the output signal is 0~10v or 4~20mA. The setting of the output signal is at Pr03-10 and Pr03-11. The maximum pressure can be set at Pr00-08)
	EMI Filter	Optional (Refer to Appendix A-7)
Protection Feature	Motor Protection	Electronic thermal relay protection
	Over Current Protection	Over current protection is activated at 300% of the rated current
	Ground Leakage Current Protection	Activated when the leakage current is higher than 50% of the drive's rated current
	Voltage Protection	Over Voltage Level: Vdc>400/800 V; Low Voltage Level: Vdc<200/400 V
	Input Power Supply Over Voltage Protection	Metal Oxide Varistor (MOV)
	Over Temperature Protection	Built-in temperature sensor
Environment	Protection Level	NEMA 1/IP20
	Operation Temperature	-10°C~45°C
	Storage Temperature	-20°C~60°C
	Humidity	Below 90% RH (non-condensing)
	Vibration	1.0G below 20Hz, 0,6G at 20~60 Hz
	Cooling System	Forced air cooling
	Installation Altitude	Altitude below 1,000m, keep from corrosive gasses, liquid and dust
International Certification		

1-3 Overview of Hybrid Servo Systems

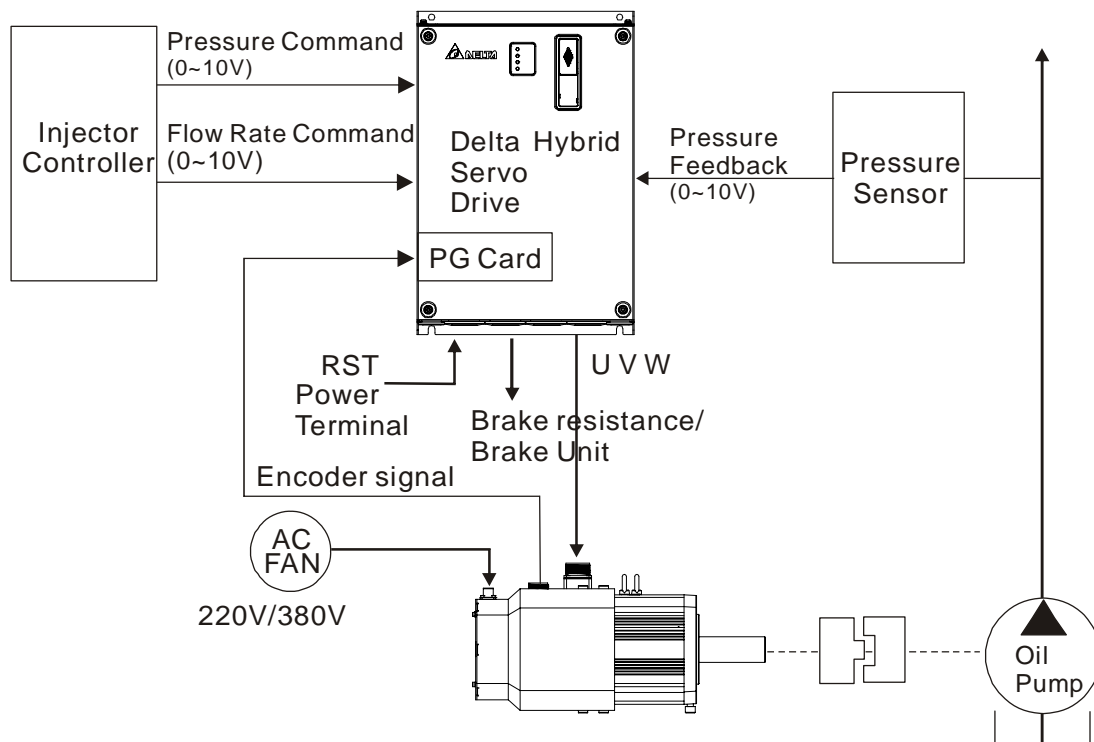

1-3-1 Selection of Hybrid Servo Drives and Motors

Due to the differences in the hydraulic system in practical applications, the following choice of drives and motors is provided as a reference.

In the following example, a flow of 64L/min and maximum holding pressure of 175Bar are used.

1. Pump Displacement per Revolution

Based on the maximum flow of the system (L/min), the pump displacement per revolution (cc/rev) can be calculated.

Example: If the maximum flow of the system is 64L/min and the highest rotation speed of the motor is 2000rpm, the displacement per revolution is $64/2000 \times 1000 = 32$ cc/rev.

2. Maximum Torque of the Motor

Based on the maximum pressure (Mpa) and pump displacement per revolution (cc/rev), the maximum torque can be calculated.

Example: For the required maximum pressure of 17.5 Mpa and pump displacement per revolution of 32cc/rev

Torque = $17.5 \times 32 \times 1.3 / (2 \times \pi) = 116$ N-m, where the factor 1.3 is used to compensate the total loss in the system.

3. Rated Torque and Rated Power of the Motor

At the maximum pressure for the holding pressure, the required torque should be 1.5 times of the motor's rated torque or less (depending on the data provided by the motor's

manufacturer). Over such an operating condition, the over-temperature of the motor may easily occur. Let us take the factor 1.5 as an example, if the rated torque of the motor is 77 N-m, the motor with a power of 12kW* and a rated speed of 1500 rpm can be chosen.

*The power of the motor is calculated by using $P(W) = T(N - m) \times \omega(rpm \times 2\pi / 60)$

4. Maximum Current of the Motor

Example: Check the parameter kt (Torque/A) in the motor's specifications, if kt = 3.37, the maximum current is approximately $116/3.37 = 34A$ at the maximum torque of 116 N-m.

5. Selection of Matched Hybrid Servo Drive

Example: Look up the over-load capability for each Hybrid servo drive in the product specification chart

If the holding pressure is at the maximum pressure of 17.5 Mpa, and a pump of 32cc/rev is used, the required motor current is approximately 34A

For such a current value, the following models can be chosen

VFD075VL43A-J, the overload may occur within 20 sec.

VFD110VL43A-J, the overload may occur approximately after 60 sec.

NOTE

If there is no suitable motor that meets the specifications, a motor with a higher rated value can be used instead.

For any information about the Hybrid servo drives or any assistance in detailed configuration of your company's products, please contact the manufacturer.

1-3-2 Selection of Pump for Hybrid Servo Motor

Select a pump with a suitable displacement based on the required flow rate and motor speed;

- If low noise is required, you can choose the screw pump or internal gear type. If a high volumetric efficiency is required, you can choose the piston pump or dual displacement piston pump.
- Comparison of Commonly Used Pump (This may vary for different pump manufacturers).

Type of Oil Pump	Volumetric Efficiency	Flow Pulsation	Rotation Speed	Noise
Internal Gear Pump	Low	Medium	Medium	Low
Piston Pump	High	Low	Low	High
Screw Pump	Medium	High	High	Medium

1-4 Product Installation

Please install the Hybrid servo drive under the following environmental conditions to ensure safety of use:

Environmental Condition for Operation	Ambient temperature Relative Humidity Pressure Installation Altitude Vibration	-10°C~ +45°C <90% (non-condensing) 86 ~ 106 kPa <1000m <20Hz: 9.80 m/s ² (1G) max; 20~50H:5.88 m/s ² (0.6G) max
Environmental Condition for Storage and Transportation	Ambient temperature Relative Humidity Pressure Vibration	-20°C~ +60°C (-4°F ~ 140°F) <90% (non-condensing) 86 ~ 106 kPa <20Hz: 9.80 m/s ² (1G) max; 20 ~ 50Hz: 5.88 m/s ² (0.6G) max
Contamination Protection Level	Level 2: Applicable to factory environment with low-to-medium contamination	

Space for Installation

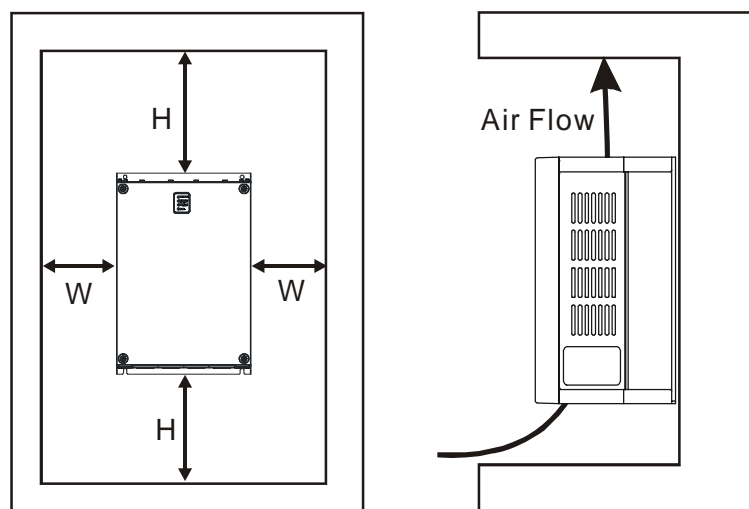

HP	W mm (inch)	H mm (inch)
7.5-20HP	75 (3)	175 (7)
25-75HP	75 (3)	200 (8)
100HP	75 (3)	250 (10)

1. Mount the Hybrid servo drive vertically on a flat vertical surface object by screws. Other directions are not allowed.
2. The Hybrid servo drive will generate heat during operation. Allow sufficient space around the unit for heat dissipation.

3. The heat sink temperature may rise to 90°C when running. The material on which the Hybrid servo drive is mounted must be noncombustible and be able to withstand this high temperature.
4. When Hybrid servo drive is installed in a confined space (e.g. cabinet), the surrounding temperature must be within -10 ~ 40°C with good ventilation. DO NOT install the Hybrid servo drive in a space with bad ventilation.
5. When installing multiple Hybrid servo drives in the same cabinet, they should be adjacent in a row with enough space in-between. When installing one Hybrid servo drive below another one, use a metal separation between the Hybrid servo drives to prevent mutual heating.
 - Prevent fiber particles, scraps of paper, saw dust, metal particles, etc. from adhering to the heatsink.

Lifting

Please carry only fully assembled Hybrid servo drives as shown in the following. Lift the Hybrid servo drive by hooking the lifting hole.

40-100HP (Frame No. E)

Step 1

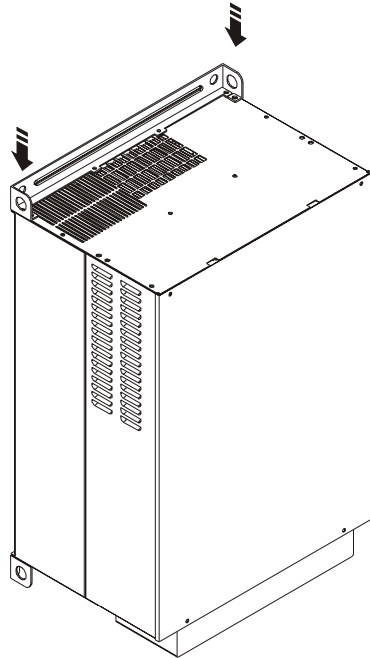

Step 2

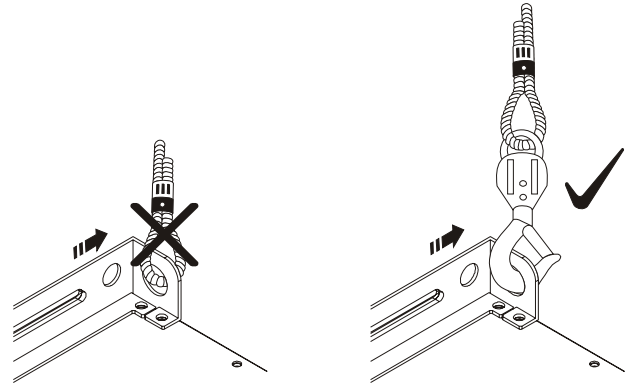

Step 3

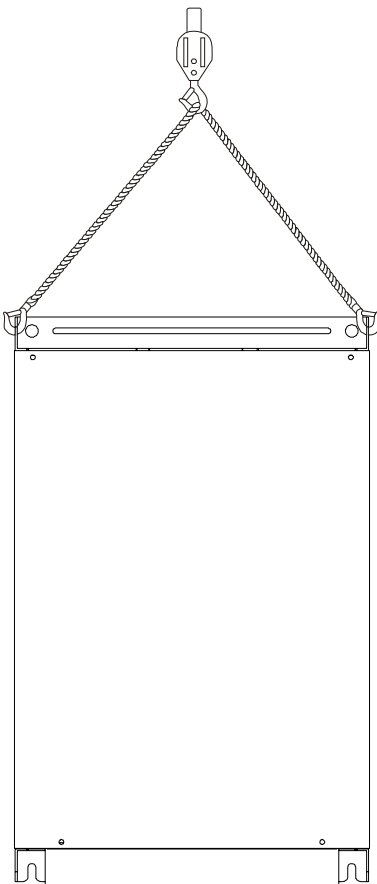

Step 4

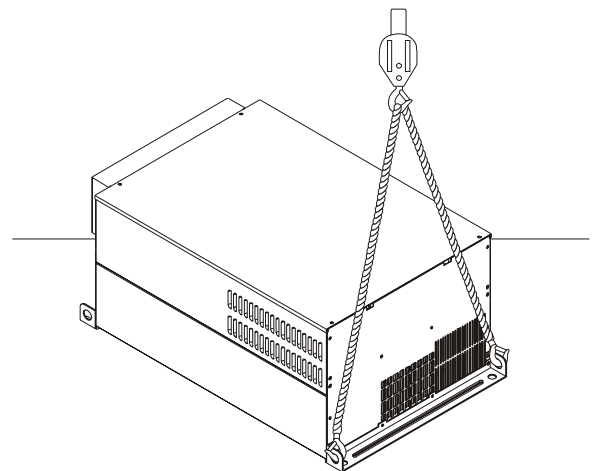

Flange Mounting

Step 1:

Please take out the 16 screws (8 screws for each top and bottom side of the drive) and remove the fixed plate 1 and fixed plate 2) as shown in the following figures.

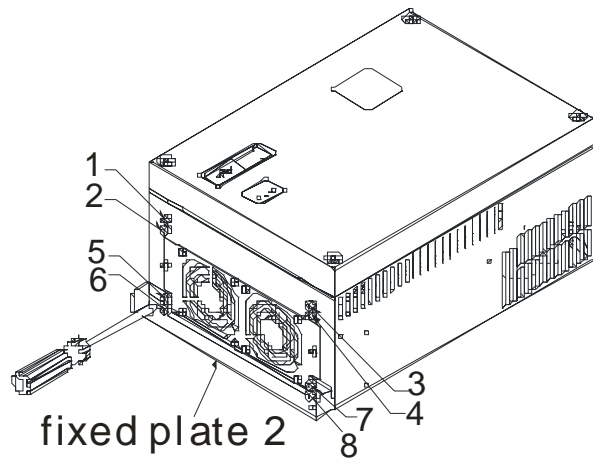
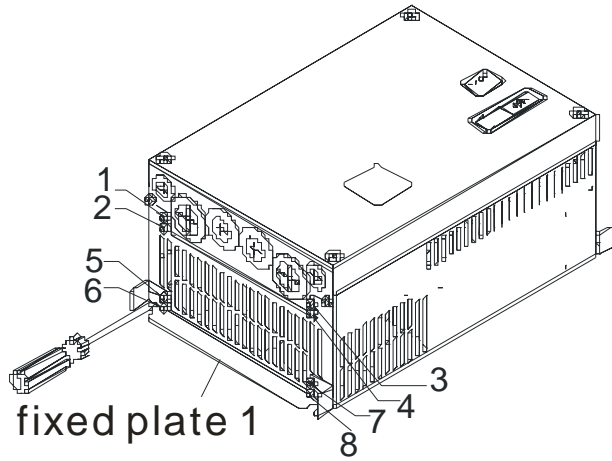

Step 2:

place the 8 screws back in to secure the fixed plate 1 and fixed plate 2 (as shown in the following figures) with the following torque.

Frame No. C: 14-17kgf-cm

[12.2-14.8in-lbf]

Frame No. D: 20-25kgf-cm

[17.4-21.7in-lbf]

Frame No. E: 20-25kgf-cm

[17.4-21.7in-lbf]

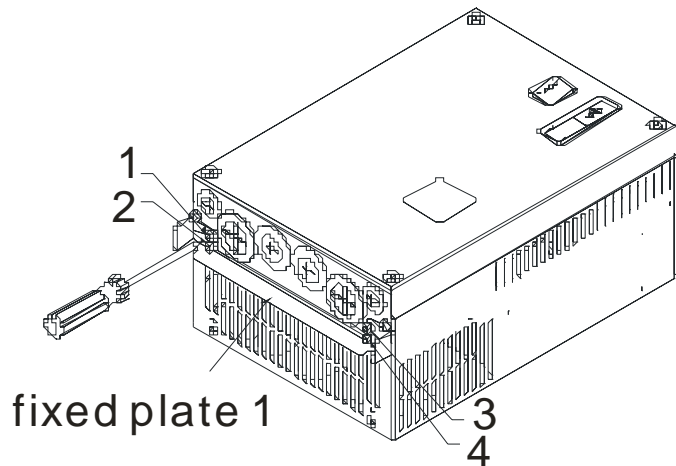

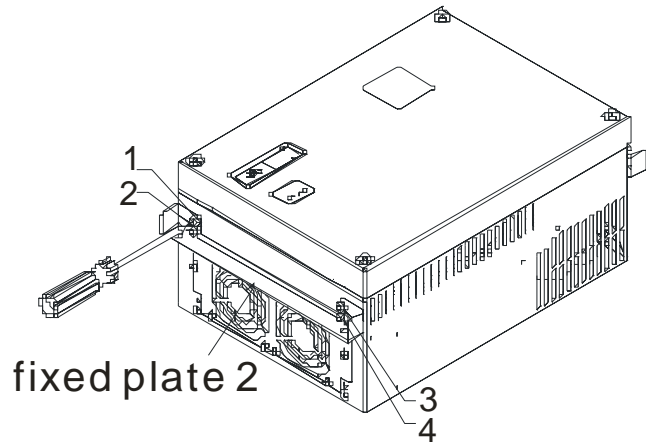

Step 3:

Please notice that it doesn't need to put those 8 screws shown in the following figures back to the drive. Moreover, please make sure that these 2 different fixed plates are put in the correct side as shown in the figures.

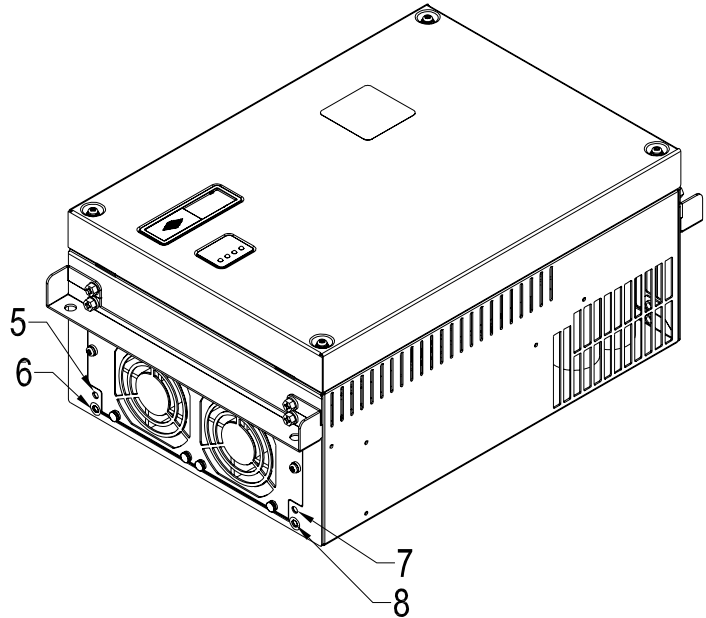
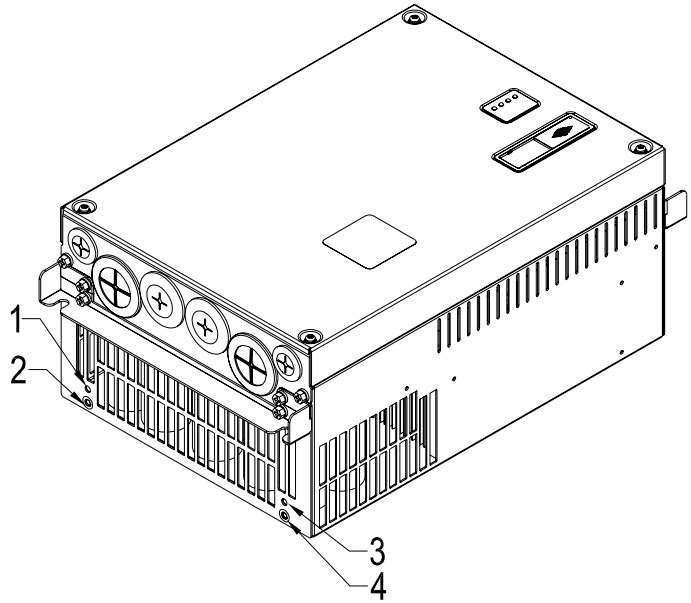

1-5 Product Dimensions

Frame C

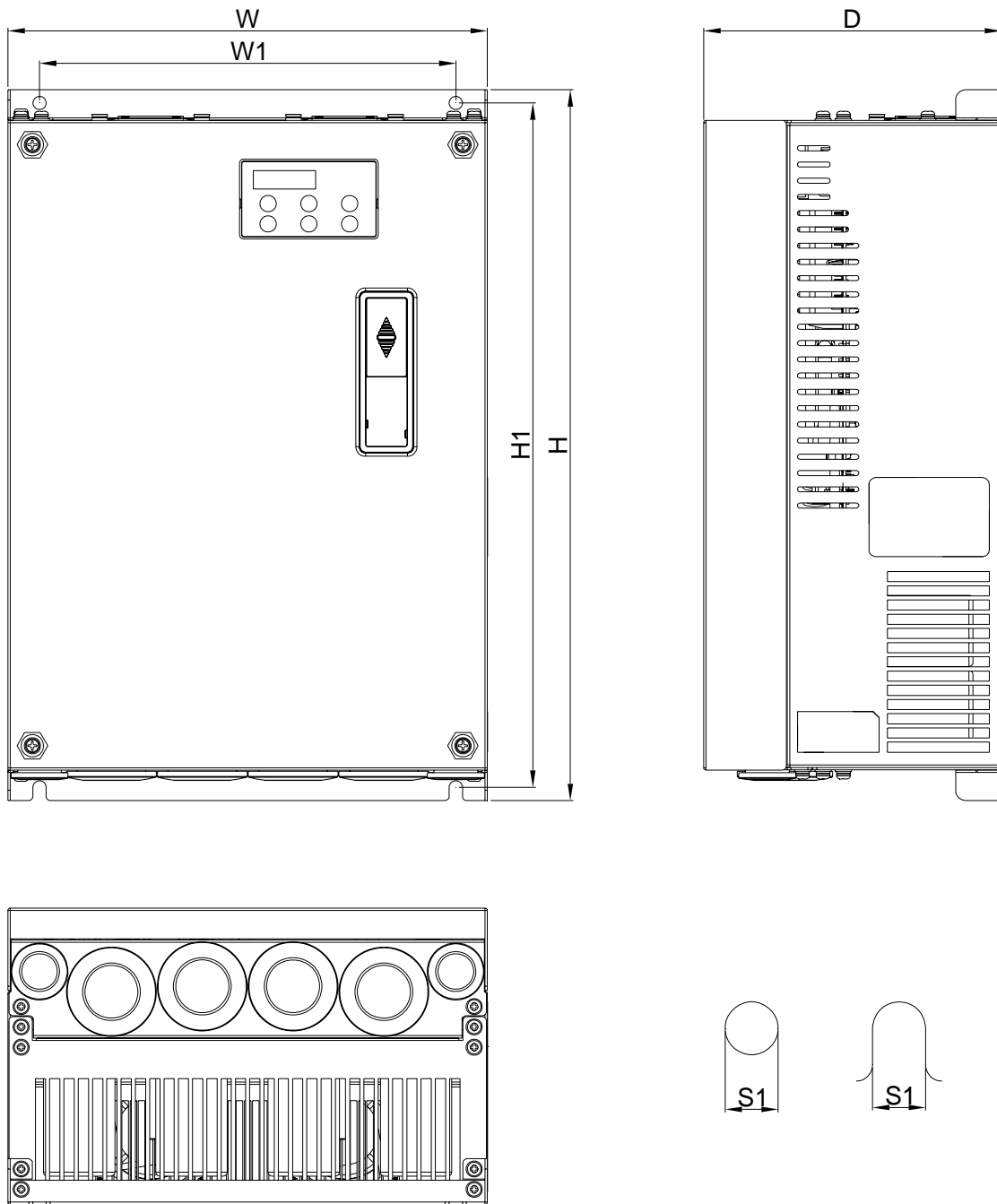

Unit: mm [inch]

Frame	W	W1	H	H1	H2	H3	D	Ø	Ø1	Ø2	Ø3
C	235 [9.25]	204 [8.03]	350 [13.78]	337 [13.27]	320 [12.60]	-	136 [5.35]	6.5 [0.26]	-	34 [1.34]	22 [0.87]

 **NOTE**

Frame C: VFD055VL23A/43A-J, VFD075VL23A/43A-J, VFD110VL23A/43A-J, VFD150VL43B-J, VFD185VL43B-J

Frame D

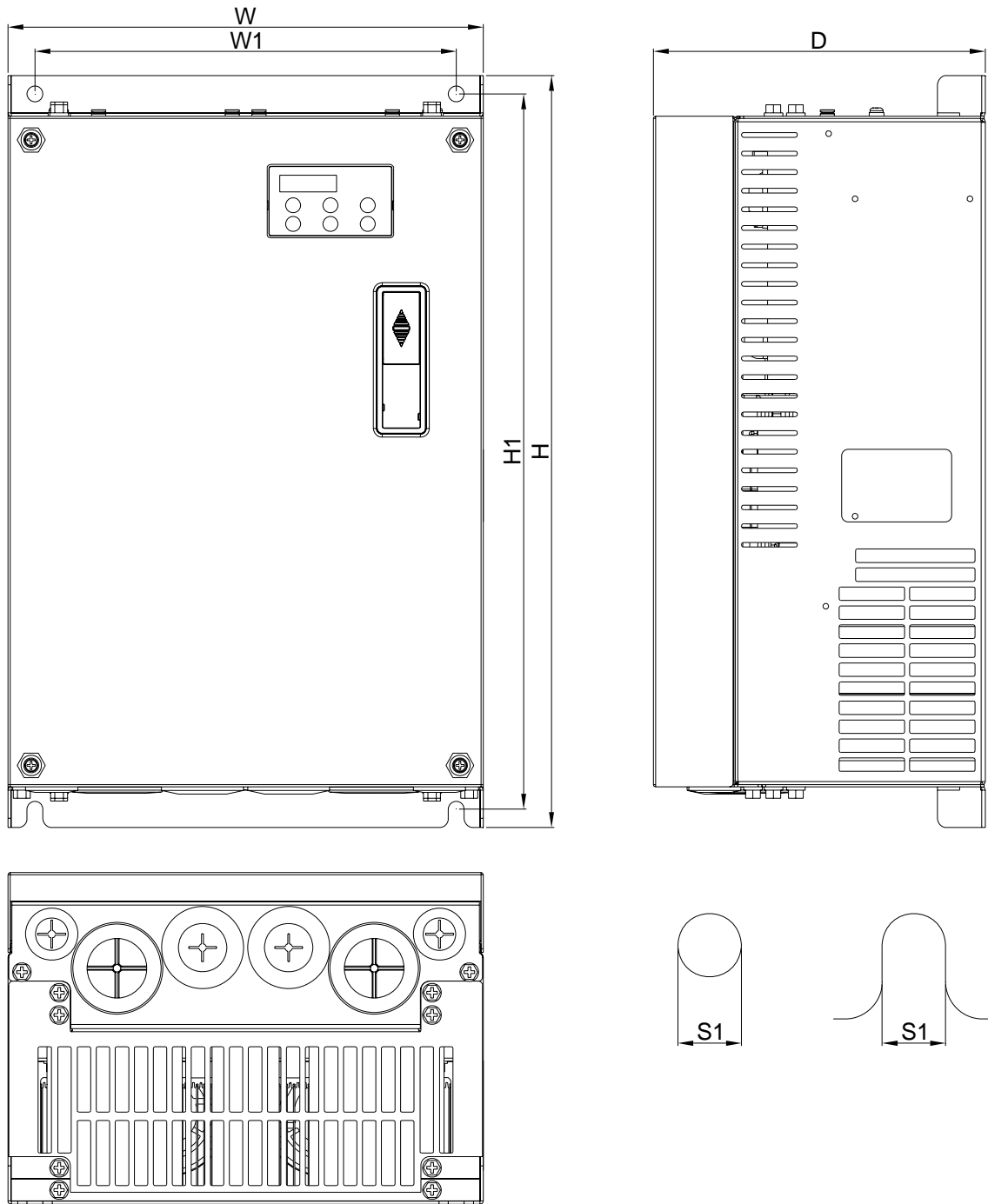

Unit: mm [inch]

Frame	W	W1	H	H1	H2	H3	D	Ø	Ø1	Ø2	Ø3
D	255.0 [10.04]	226.0 [8.90]	403.8 [15.90]	384.0 [15.12]	360.0 [14.17]	21.9 [0.86]	168.0 [6.61]	8.5 [0.33]	44 [1.73]	34 [1.34]	22 [0.87]

NOTE

Frame D: VFD150VL23A/43A-J, VFD185VL23A/43A-J, VFD220VL23A/43A-J, VFD300VL43B-J

Frame E0

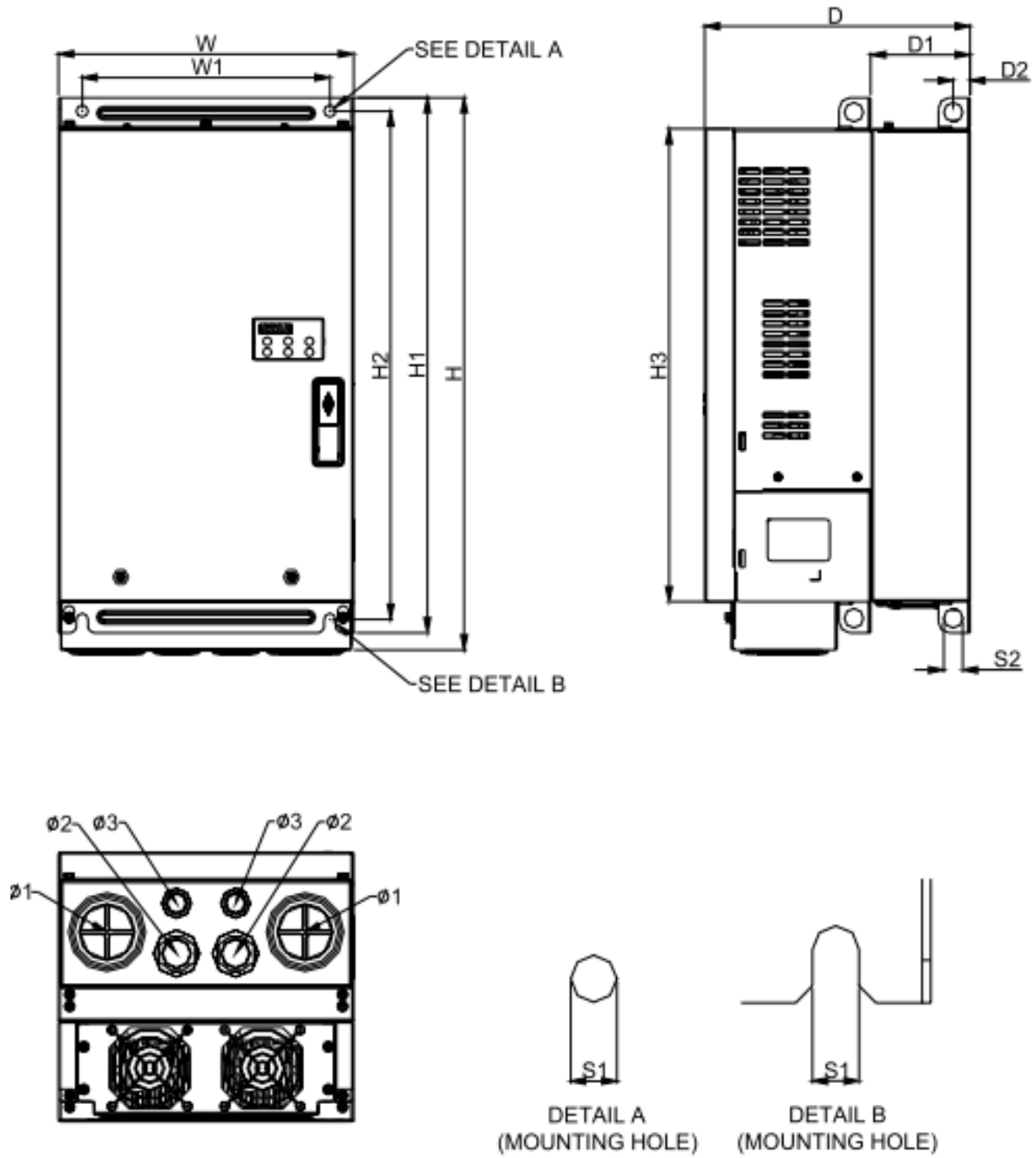

Unit: mm[inch]

Frame	W	W1	H	H1	H2	H3	D	D1*	D2	S1	S2	Ø1	Ø2	Ø3
E0	280.0 [11.02]	235.0 [9.25]	516 [20.31]	500.0 [19.69]	475 [18.70]	442.0 [17.40]	251.7 [9.91]	94.2 [3.71]	16.00 [0.63]	11.00 [0.43]	18.0 [0.71]	62.7 [2.47]	34.0 [1.34]	22.0 [0.87]

NOTE

Frame E0: VFD370VL43B-J

Frame E

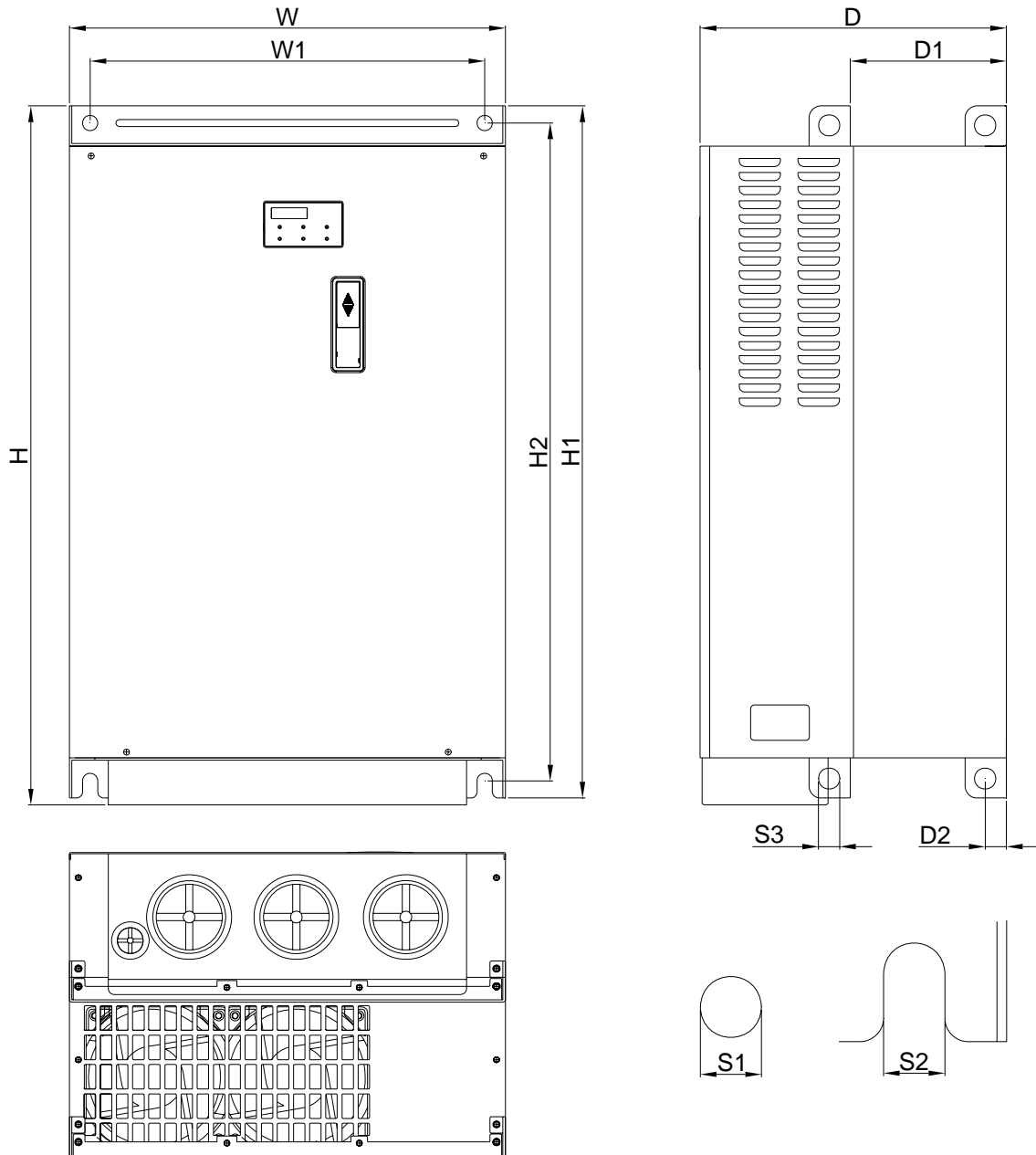

Unit: mm [inch]

Frame	W	W1	H	H1	H2	D	D1:	D2:	S1	S2	S3
E1	370.0	335.0	-	589.0	560.0	260.0	132.5	18.0	13.0	13.0	18.0
	[14.57]	[13.19]		[23.19]	[22.05]	[10.24]	[5.22]	[0.71]	[0.51]	[0.51]	[0.71]
E2	370.0	335.0	595.0	589.0	560.0	260.0	132.5	18.0	13.0	13.0	18.0
	[14.57]	[13.19]	[23.43]	[23.19]	[22.05]	[10.24]	[5.22]	[0.71]	[0.51]	[0.51]	[0.71]

NOTE

Frame E1: VFD300VL43A-J, VFD370VL43A-J, VFD450VL43A-J,

Frame E2: VFD300VL23A-J, VFD370VL23A-J, VFD550VL43A-J, VFD750VL43A-J,

Frame E

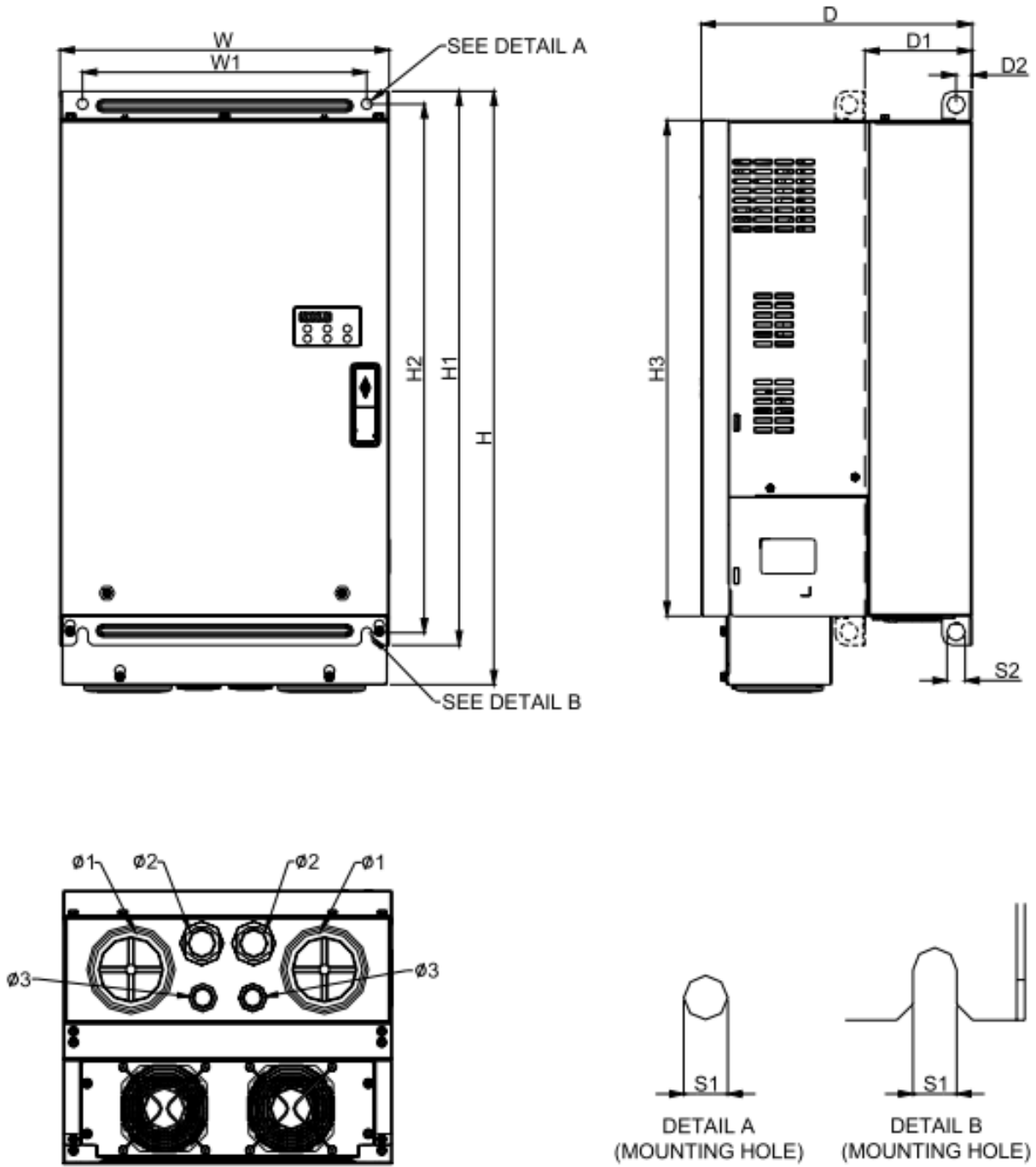

Unit: mm[inch]

Frame	W	W1	H	H1	H2	H3	D	D1*	D2	S1	S2	Ø1	Ø2	Ø3
E3	330.0	285.0	589.0	550.0	525.0	492.0	271.6	107.2	16.00	11.00	18.0	76.2	34.0	22.0
	[12.99]	[11.22]	[23.19]	[21.65]	[20.67]	[19.37]	[10.69]	[4.22]	[0.63]	[0.43]	[0.71]	[3.00]	[1.34]	[0.87]

NOTE

Frame E3: VFD450VL43B-J

2. Wiring

2-1 Description of Wiring

2-2 Description of Terminals on Main Circuit

2-3 Description of Terminals on Control Circuit

After removing the front cover , check if the power and control terminals are clear. Be sure to observe the following precautions when wiring.

- Make sure that power is only applied to the R/L1, S/L2, T/L3 terminals. Failure to comply may result in damage to the equipments. The voltage and current should lie within the range as indicated on the nameplate
- All the units must be grounded directly to a common ground terminal to prevent lightning strike or electric shock.
- Please make sure to fasten the screw of the main circuit terminals to prevent sparks which is made by the loose screws due to vibration



- It is crucial to turn off the Hybrid servo drive power before any wiring installation are made. A charge may still remain in the DC bus capacitors with hazardous voltages even if the power has been turned off therefore it is suggested for users to measure the remaining voltage before wiring. For your personnel safety, please do not perform any wiring before the voltage drops to a safe level < 25 Vdc. Wiring installation with remanding voltage condition may caus sparks and short circuit.
- Only qualified personnel familiar with Hybrid servo drives is allowed to perform installation, wiring and commissioning. Make sure the power is turned off before wiring to prevent electric shock.



- Make sure that power is only applied to the R/L1, S/L2, T/L3 terminals. Failure to comply may result in damage to the equipment. The voltage and current should lie within the range as indicated on the nameplate.
- Check following items after finishing the wiring:
 1. Are all connections correct?
 2. No loose wires?
 3. No short-circuits between terminals or to ground?

2-1 Description of Wiring

Users must connect wires according to the circuit diagrams on the following pages.

Standard wiring diagram of the VFD-VJ Hybrid servo drive in factory

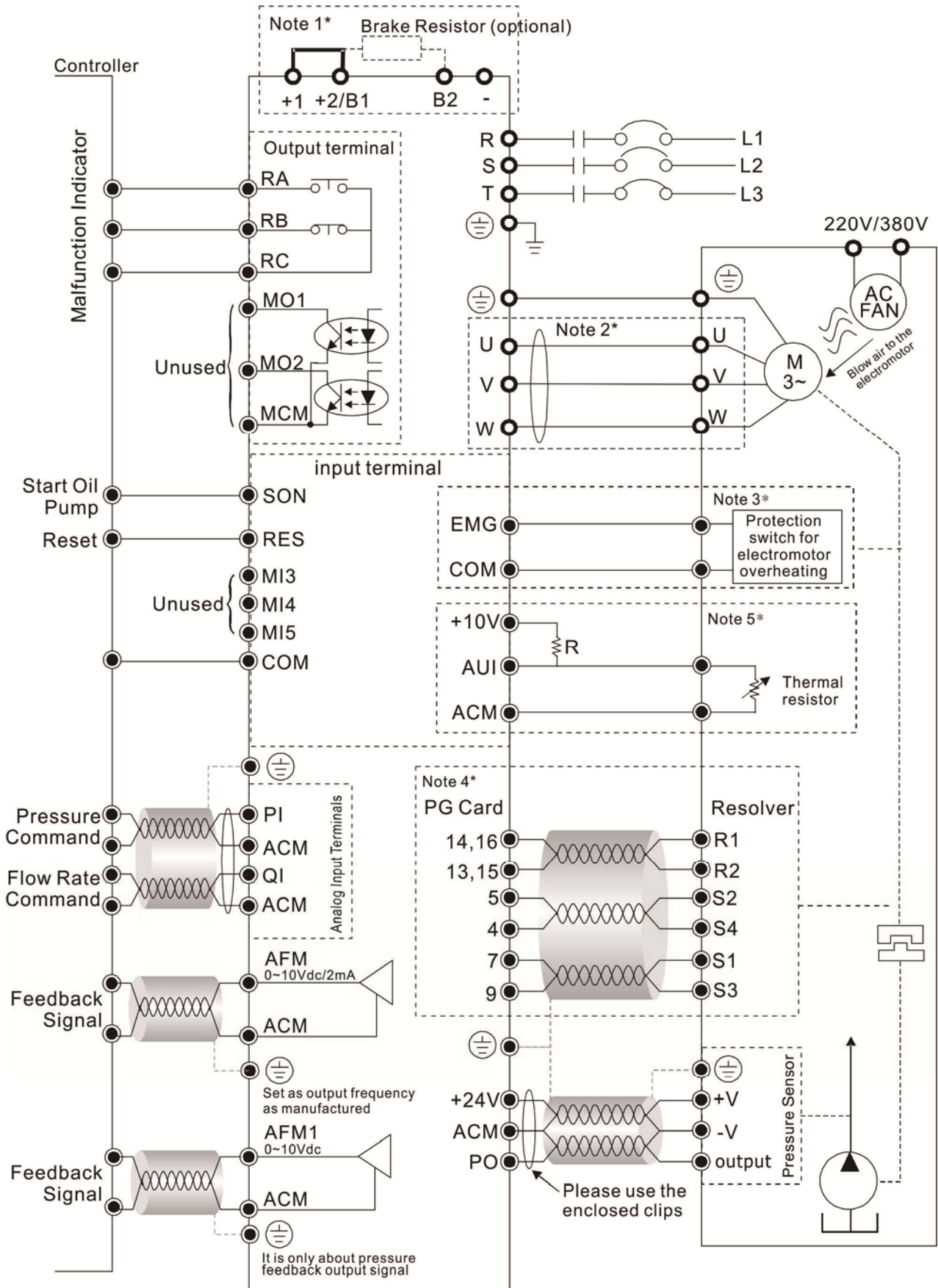

Built-in with Braking Unit

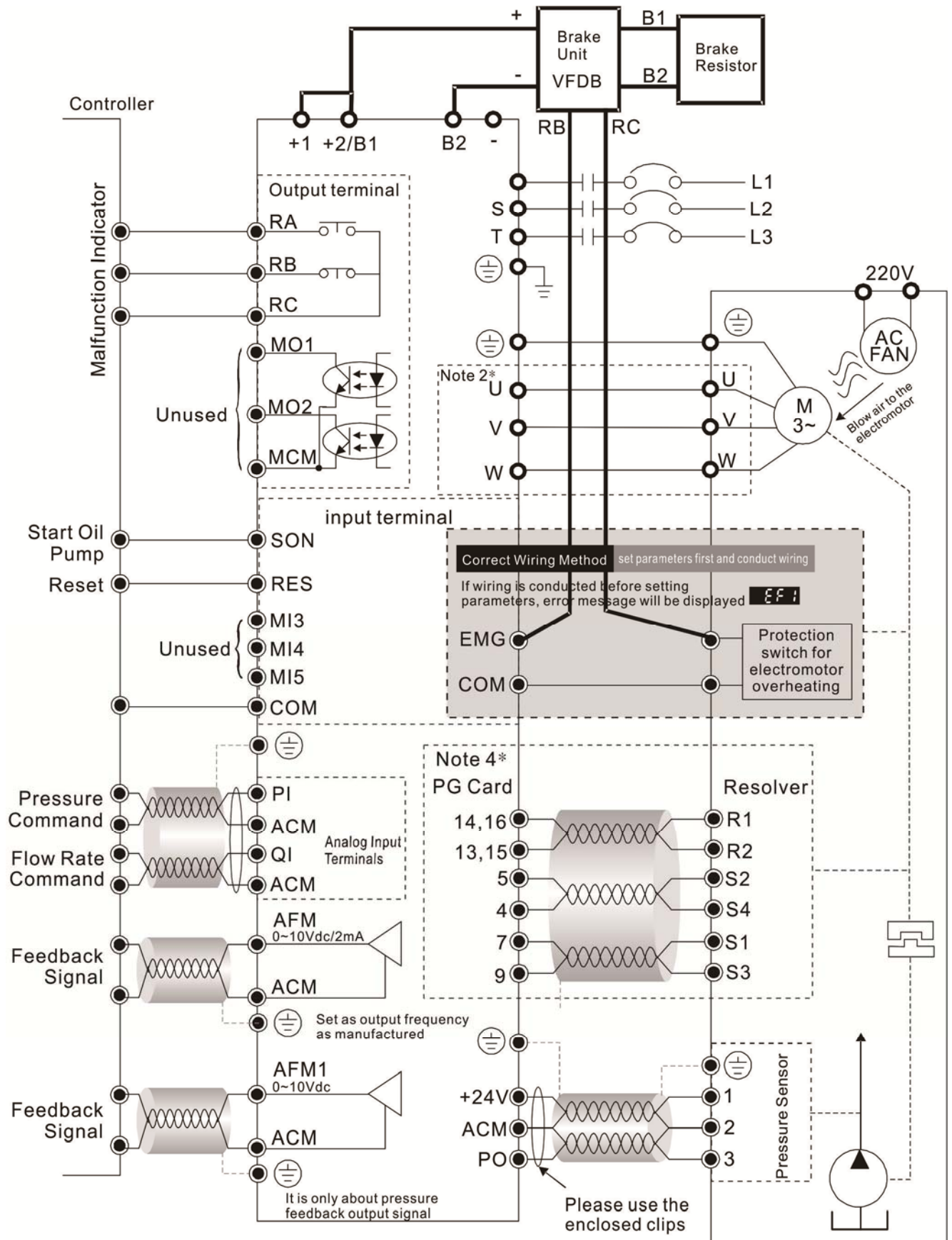

Note 1*

For models 220V_22kW(included) and 440V_30kW(included) and below. (With internal brake unit)

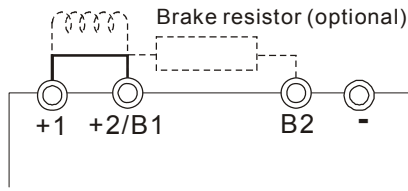

For models 440V_37kW(included) and above, also for models 220V_30kW(included) and above)

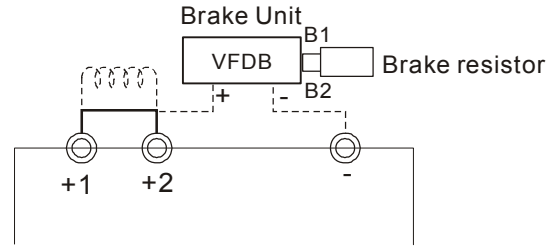

Note 2*

For models with power rating below 22kW (including 22kW)
(it is recommended to wrap the output wire around the zero-phase reactor for over three times before connecting it to the motor)

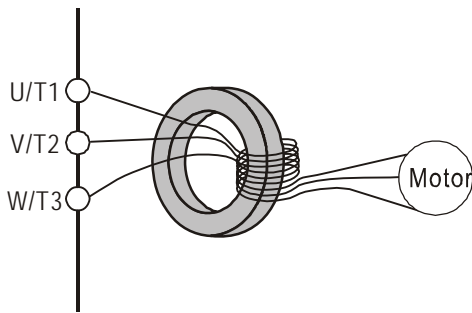

For models with power rating below 30kW (including 30kW)

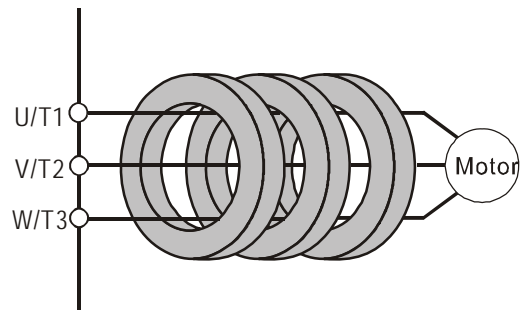

Note 3*

If the motor's temperature protection switches are normally close type, please set the Parameter 03-04 to 4 first, and then carry out the wiring. In this case, the drive may display the EF1 error message. Just clear the message.

Note 4*

EMVJ-PG02R

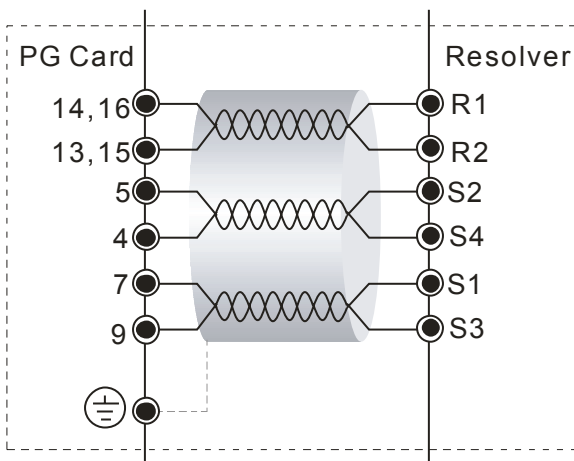

EMVJ-PG01U

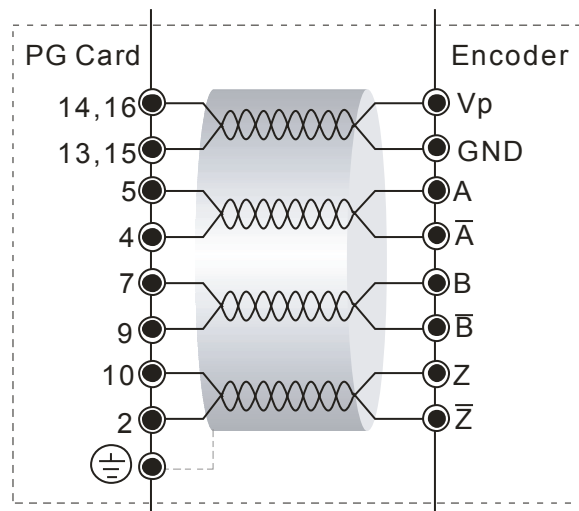

Note 5*

Please select the R value in accordance with the thermistor specifications. The related trigger level can be configured by the Parameters 02-08 to 02-10. If the thermistor of Model Number KTY84 is used, select the R value as $2k\Omega (1/4W) \pm 0.1\%$, and set the Parameter 02-11 with the value of 1.

Multi-pump Operation Mode

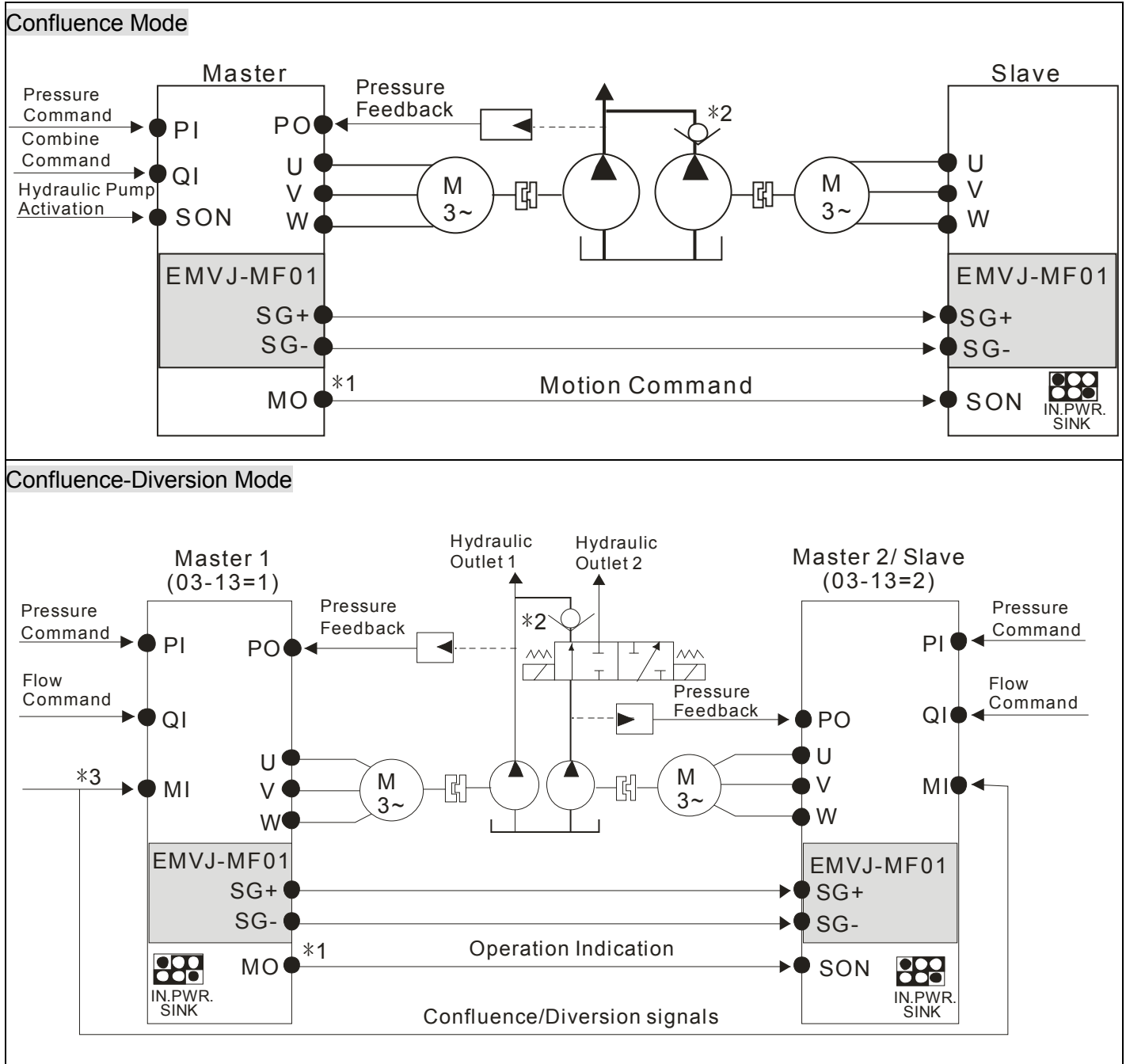

NOTE

- *1 For firmware version 2.03 and above, the operating commands are given through the communications. Therefore, the parameters for the slave is 01-01 = 2
- *2 For firmware version 2.03 and above, it is not necessary to install this check valve. By selecting the slave parameter 03-21 at the slave to see if the slave will perform the reverse depressurization. Parameters 03-21 = 0 for not performing the reverse depressurization.
- *3 For firmware version 2.03 and above, the diversion/confluence signal is supplied to only Master 2/Slave. It is

not necessary to supply the signal to Master 1. For the following control arrangement, it is necessary to disconnect the communications during diversion.

When the signals are Confluence, the communication will be a short circuit
 When the signals are Diversion, the communication becomes an open circuit.

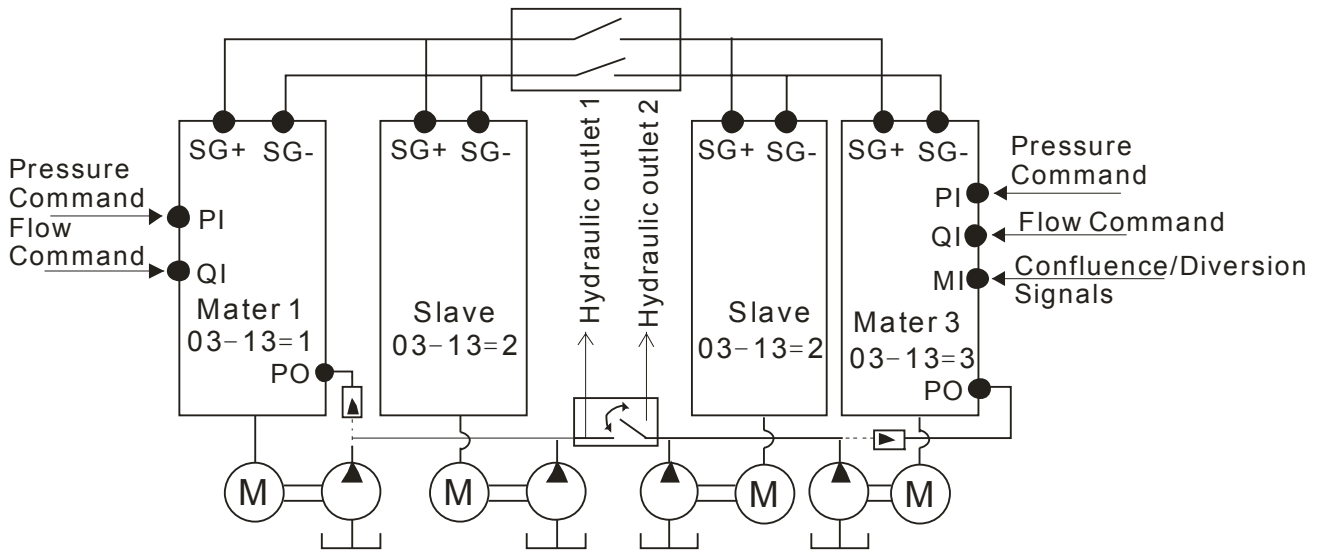

- ☑ The wiring of main circuit and control circuit should be separated to prevent erroneous actions.
- ☑ Please use shield wire for the control wiring and not to expose the peeled-off net in front of the terminal.
- ☑ Please use the shield wire or tube for the power wiring and ground the two ends of the shield wire or tube.
- ☑ Make sure that the leads are connected correctly and the AC drive is properly grounded. (Ground resistance should not exceed 0.1Ω .)
- ☑ Multiple VFD-VJ units can be installed in one location. All the units should be grounded directly to a common ground terminal, as shown in the figure below.

Ensure there are no ground loops.

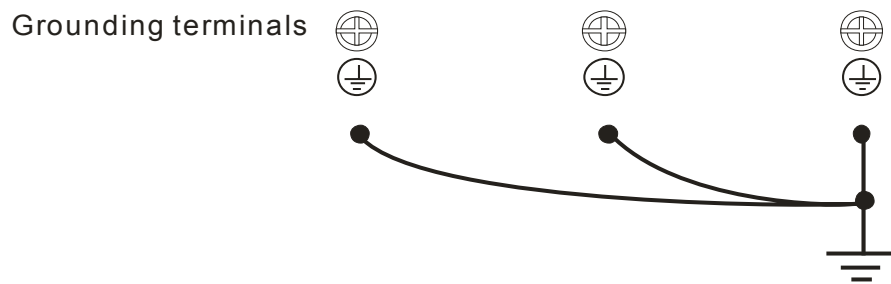

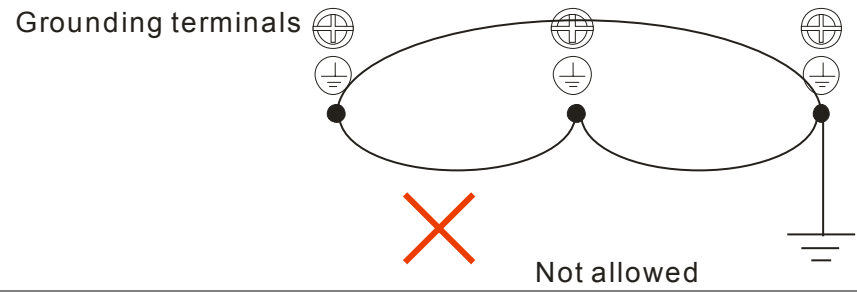
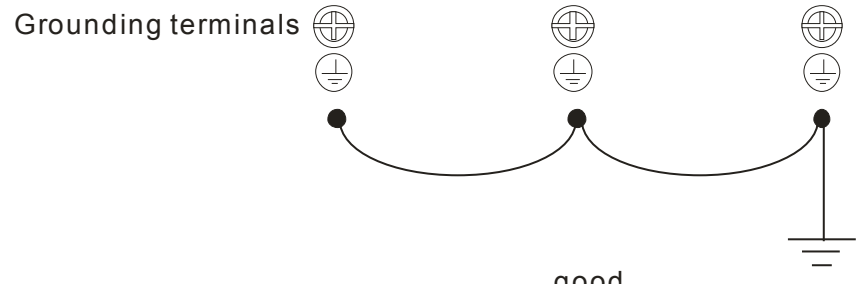

2-2 Description of Terminals on Main Circuit

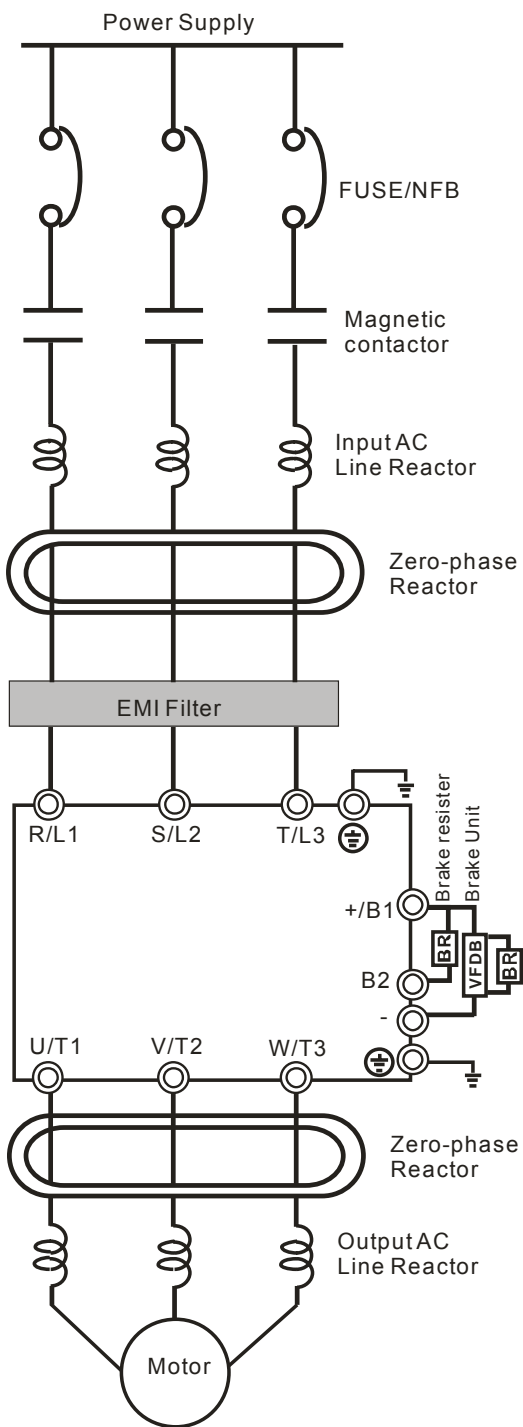

Items	Explanations
Power supply	Please follow the specific power supply requirements shown in Chapter 01.
Fuse/NFB (Optional)	There may be an inrush current during power up. Please check the chart of Appendix A-2 and select the correct fuse with rated current. Use of an NFB is optional.
Magnetic contactor (Optional)	Please do not use a Magnetic contactor as the I/O switch of the AC motor drive, as it will reduce the operating life cycle of the AC drive.
Input AC Line Reactor (Optional)	Used to improve the input power factor, to reduce harmonics and provide protection from AC line disturbances (surges, switching spikes, short interruptions, etc.). AC line reactor should be installed when the power supply capacity is 500kVA or more and exceeds 6 times the inverter capacity, or the mains wiring distance $\leq 10m$.
Zero-phase Reactor (Ferrite Core Common Choke) (Optional)	Zero phase reactors are used to reduce radio noise especially when audio equipment is installed near the inverter. Effective for noise reduction on both the input and output sides. Attenuation quality is good for a wide range from AM band to 10MHz. Appendix A specifies the zero phase reactor. (RF220X00A)
EMI filter (Optional)	To reduce electromagnetic interference, please refer to Appendix B for more details.
Brake Resistor (Optional)	Used to reduce the deceleration time of the motor. Please refer to the chart in Appendix A for specific Brake Resistors.
Output AC Line Reactor (Optional)	Motor surge voltage amplitude depends on motor cable length. For applications with long motor cable (>20m), it is necessary to install a reactor at the inverter output side.

Motor

Terminal Identification	Description
R/L1, S/L2, T/L3	AC line input terminals 3-phase
U/T1, V/T2, W/T3	Output terminals of the Hybrid servo drive that are connected to the motor
+1, +2/B1	Connections for DC reactor to improve the power factor. It needs to remove the jumper for installation. (DC reactor is built in for models $\geq 22KW$)
+2/B1, B2	Connections for Brake Resistor (optional)
⊕	Earth connection, please comply with local regulations.



Power supply input terminals for the main circuit:

- ☑ Do not connect 3-phase model to one-phase power. R/L1, S/L2 and T/L3 has no phase-sequence requirement, it can be used upon random selection..
- ☑ It is recommend to add a magnetic contactor (MC) to the power input wiring to cut off power quickly and reduce malfunction when activating the protection function of the AC motor drive. Both ends of the MC should have an R-C surge absorber.
- ☑ Fasten the screws in the main circuit terminal to prevent sparks condition made by the loose screws due to vibration.
- ☑ Please use voltage and current within the specification.. Please refer to Chapter 1 for the specifications.
- ☑ When using a general GFCI (Ground Fault Circuit Interrupter), select a current sensor with sensitivity of 200mA or above and not less than 0.1-second operation time to avoid nuisance tripping.
- ☑ Please use the shield wire or tube for the power wiring and ground the two ends of the shield wire or tube.

Output terminals for the main circuit:

- ☑ When it needs to install the filter at the output side of terminals U/T1, V/T2, W/T3 on the Hybrid servo drive. Please use inductance filter. Do not use phase-compensation capacitors or L-C (Inductance-Capacitance) or R-C (Resistance-Capacitance), unless approved by Delta..
- ☑ DO NOT connect phase-compensation capacitors or surge absorbers at the output terminals of Hybrid servo drives.

The terminals of the DC reactor [+ 1, +2], terminals at DC side [+ 1, +2/B1]

- ☑ This is the terminals used to connect the DC reactor to improve the power factor. For the factory setting, it connects the short-circuit object. Please remove this short-circuit object before connecting to the DC reactor.

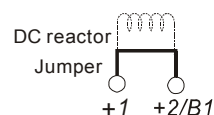

- ☑ For those models without built-in brake resistor, please connect external brake unit and brake resistor (both of them are optional) to increase brake torque.
- ☑ DO NOT connect [+1, -], [+2, -], [+1/DC+, -/DC-] or brake resistor directly to prevent drive damage.

Specifications of the Terminals on the Main Circuit

Frame C

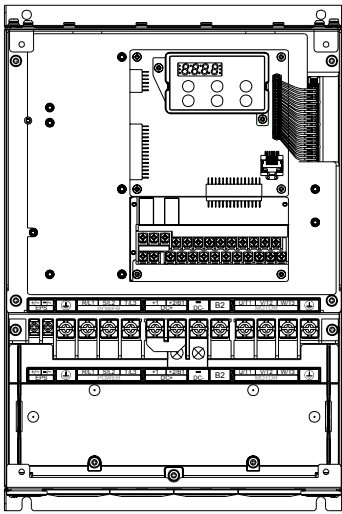

Terminals on the main circuit:

R/L1, S/L2, T/L3, U/T1, V/T2, W/T3, ⊕, +1, +2/B1, -, B2

Model	Wire Gauge	Torque	Wire Type
VFD055VL23A-J VFD110VL43A-J	10-6 AWG. (5.3-13.3mm ²)	30kgf-cm (26in-lbf)	Stranded copper only , 75°C
VFD055VL43A-J VFD075VL43A-J	12-6 AWG. (3.3-13.3mm ²)		
VFD110VL23A-J	6 AWG. (13.3mm ²)		
VFD075VL 3A-J	8-6 AWG. (8.4-13.3mm ²)		
VFD150VL43B-J VFD185VL43B-J	8-2 AWG. (8.4-33.6mm ²)		

Wire Type: Stranded copper only, 75°C

The right figure below shows the specifications of the UL certified insulation heat shrink tubing which can withstand 600V, YDPU2.

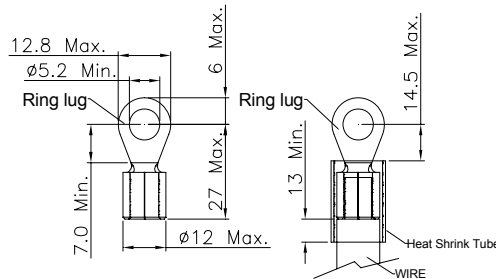

Frame D

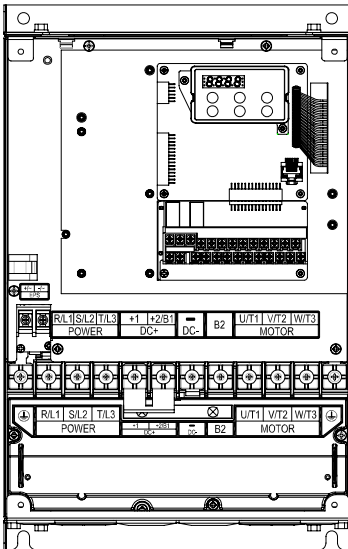

Terminals on the main circuit:

R/L1, S/L2, T/L3, U/T1, V/T2, W/T3, ⊕, +1, +2, -

Model	Wire Gauge	Torque	Wire Type
VFD150VL43A-J VFD185VL43A-J	8-2 AWG. (8.4-33.6mm ²)	50Kgf-cm (43.4 lbf-in)	Stranded copper only , 75°C
VFD150VL23A-J	4-2 AWG. (21.1-33.6mm ²)		
VFD185VL23A-J	3-2 AWG. (26.7-33.6mm ²)		
VFD220VL43A-J	6-2AWG (13.3-33.6mm ²)		
VFD220VL23A-J	3-2AWG (26.7-33.6mm ²)		
VFD300VL43B-J	4-2 AWG. (21.2-33.6mm ²)		

Wire Type: Stranded copper only, 75°C

The right figure below shows the specifications of the UL certified insulation heat shrink tubing which can withstand 600V, YDPU2.

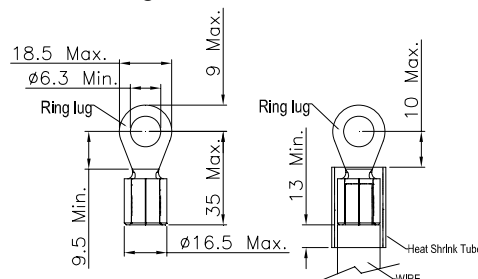

Frame E0

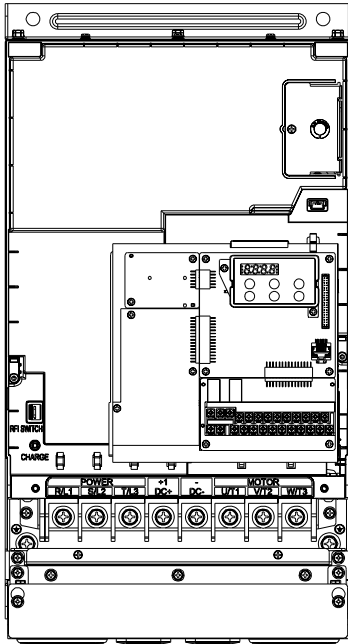

Terminals on the main circuit:

R/L1, S/L2, T/L3, U/T1, V/T2, W/T3, ⊕, +1, +2, -

Model	Max. Wire Gauge	Min. Wire Gauge	Torque
VFD370VL43B-J	2/0AWG. (67.4mm ²)	1/0AWG. (53.5mm ²)	M8 80kg-cm (70lb-in.) (7.85Nm)

Wire Type: Stranded copper only , 75°C

Specification of grounding wire ⊕: 2AWG*2 [33.6mm²*2]

1. UL installations must use 600V, 75°C or 90°C wire. Use copper wire only.
2. Figure 1 shows the terminal specification.
3. Figure 2 shows the specification of insulated heat shrink tubing that comply with UL (600V, YDPU2).

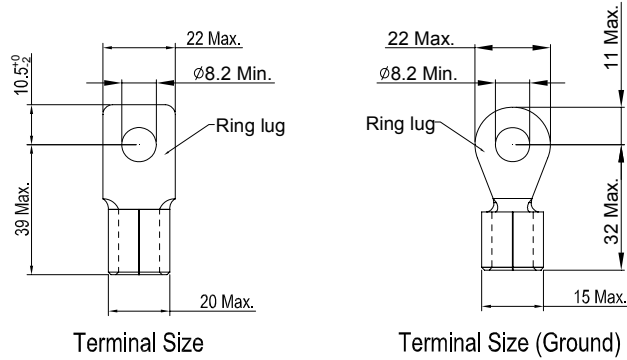

Figure 1.

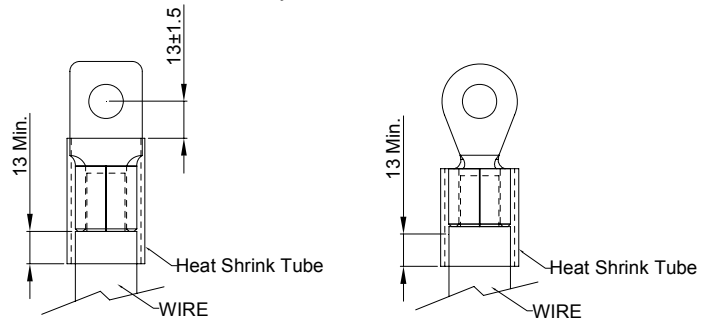
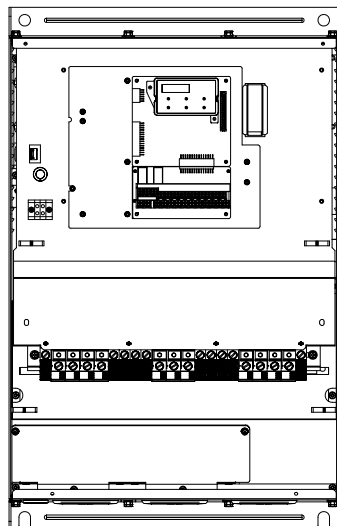

Figure 2.

Frame E



Terminals on the main circuit:

R/L1, S/L2, T/L3, U/T1, V/T2, W/T3, ⊕, +1, +2, -

Model	Wire Gauge	Torque	Wire Type
VFD300VL43A-J		57kgf-cm (49in-lbf)	Stranded copper only , 75°C
VFD370VL43A-J			
VFD450VL43A-J			
VFD300VL23A-J	200kgf-cm (173in-lbf)		
VFD370VL23A-J			
VFD550VL43A-J			
VFD750VL43A-J			

Wire Type: Stranded copper only, 75°C

Frame E3

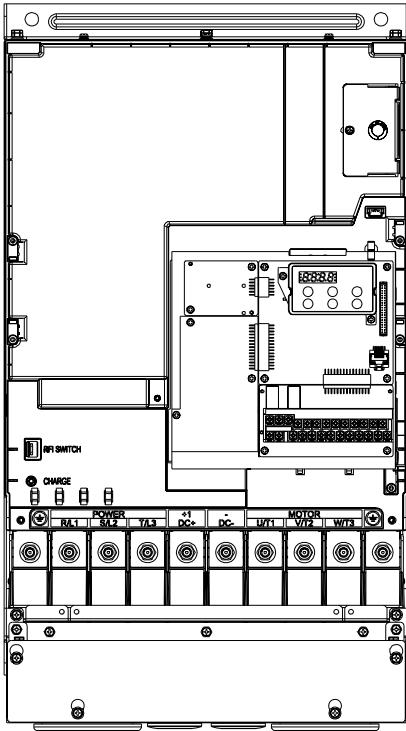

Terminals on the main circuit:

R/L1, S/L2, T/L3, U/T1, V/T2, W/T3, \oplus , +1, +2, -

Model	Max. Wire Gauge	Min. Wire Gauge	Torque
VFD450VL43B-J	2/0AWG. (67.4mm ²)	2/0AWG. (67.4mm ²)	M8 80kg-cm (70ib-in.) (7.85Nm)

Wire Type: Stranded copper only , 75°C

Specification of grounding wire \oplus : 2/0AWG [67.4mm²]

1. UL installations must use 600V, 75°C or 90°C wire. Use copper wire only.
2. Figure 1 shows the terminal specification.
3. Figure 2 shows the specification of insulated heat shrink tubing that comply with UL (600V, YDPU2).

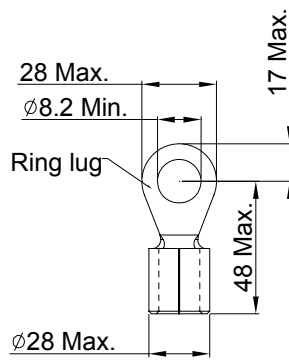

Figure 1.

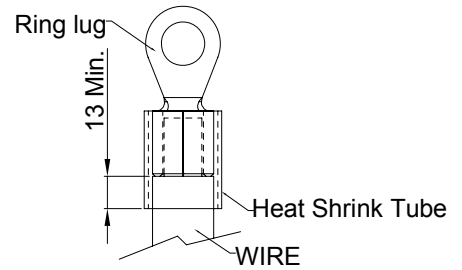
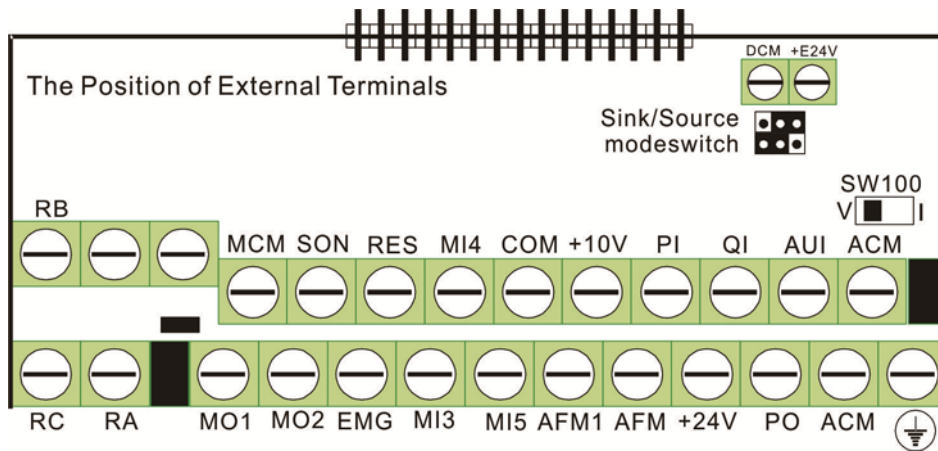
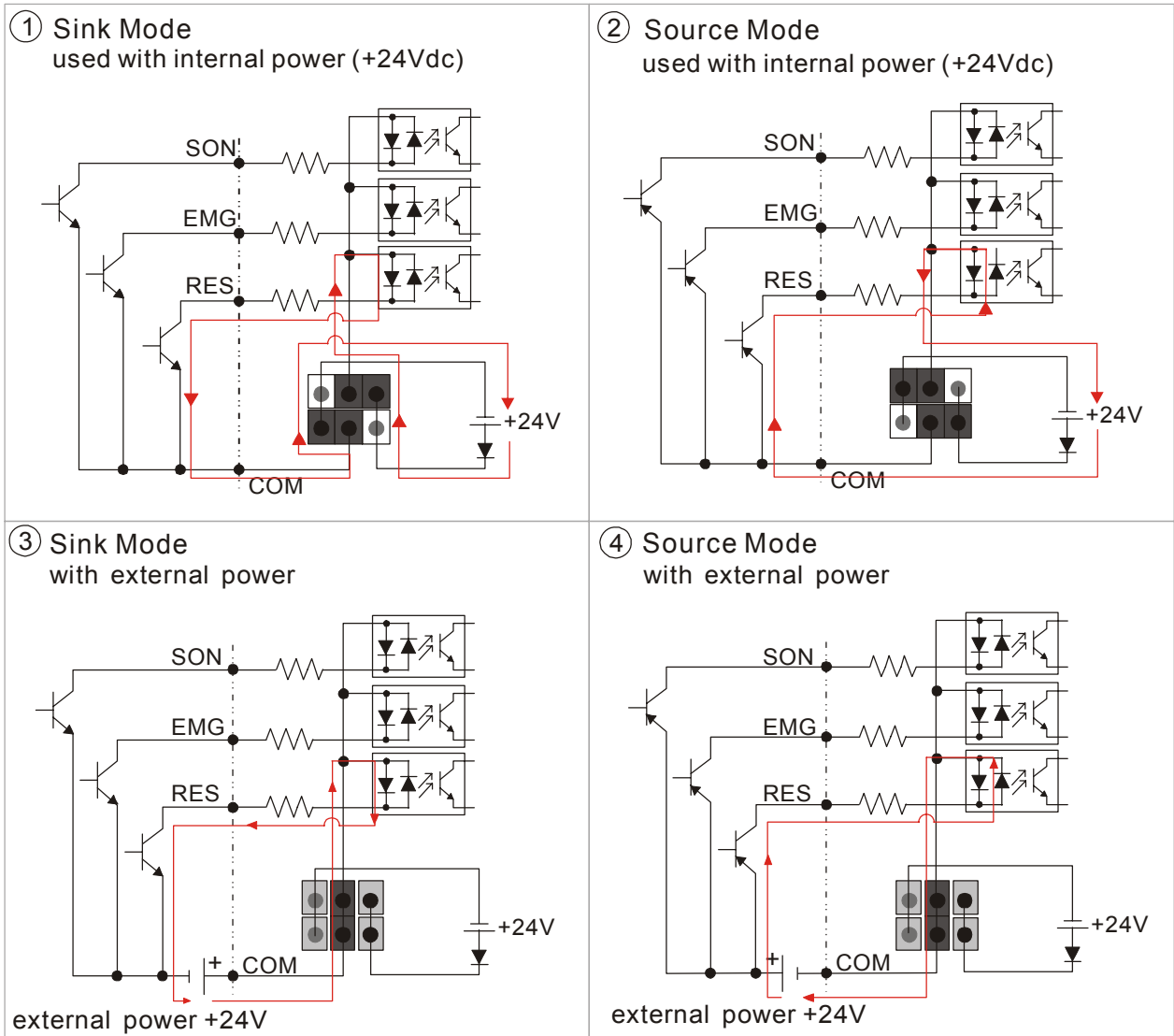

Figure 2.

2-3 Description of Terminals on Control Circuit

Description of SINK (NPN)/SOURCE (PNP) Mode Selection Terminals

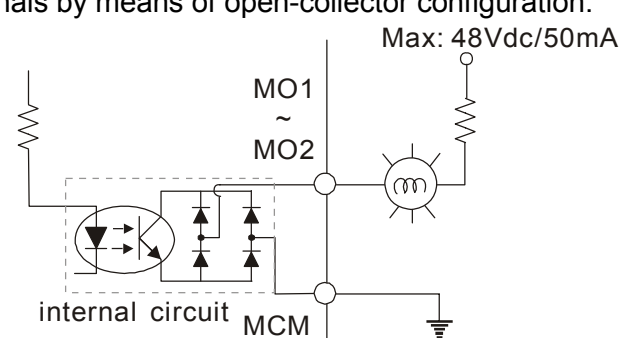
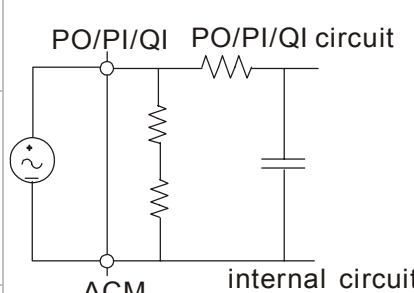

Frame No.	Torque	Wire Diameter
C, D, E	8 kgf-com (6.9 in-lbf)	22-14 AWG (0.3-2.1mm ²)
	Terminal: 0V/24V 1.6 kgf-com(1.4 in-lbf)	30-16 AWG (0.051-1.3mm ²)

Terminal	Features	Factory Setting (NPN Mode)
SON	Run-Stop	Terminal SON-COM: ON for Running; OFF for Stop
EMG	External error input	External error input
RES	Reset from error	Reset from error
MI3	Multi-function input selection 3	Configured as no function in factory
MI4	Multi-function input selection 4	When it is ON, the input voltage is 24Vdc (Max:30Vdc) and then input impedance is 3.75kΩ; when it is OFF, the tolerable leakage current is 10μA.
MI5	Multi-function input selection 5	
COM	Common ground (Sink) for digital control signals	Common ground for multi-function input terminals
+E24V	Common source for digital control signals	+24V 80mA
DCM	Common ground (Sink) for digital control signals	Common ground for multi-function input terminals
RA	Error terminal 1 (Relay N.O. a)	Resistive load 5A(N.O.)/3A(N.C.) 240VAC
RB	Error terminal 1 (Relay N.C. b)	5A(N.O.)/3A(N.C.) 24VDC
RC	Command contact for multi-function output terminals (Relay)	Inductive load 1.5A(N.O.)/0.5A(N.C.) 240VAC 1.5A(N.O.)/0.5A(N.C.) 24VDC
MO1	Multi-function output terminal 1 (photocoupler)	<p>The Hybrid servo drive sends various monitoring signals by means of open-collector configuration.</p>  <p>Max: 48Vdc/50mA</p>
MO2	Multi-function output terminal 2 (photocoupler)	
MCM	Common ground for Multi-function output terminal (photocoupler)	Max 48Vdc 50mA
PO	 <p>PO/PI/QI PO/PI/QI circuit</p> <p>ACM internal circuit</p>	Pressure feedback Impedance: 200kΩ Resolution: 12 bits Range: 0 – 10V = 0 – the maximum pressure feedback value (Parameter 00-08)
PI		Pressure Command Impedance: 200kΩ Resolution: 12 bits Range: 0 – 10V = 0 – the maximum pressure command value (Parameter 00-07)
QI		Flow rate command Impedance: 200kΩ Resolution: 12 bits Range: 0 – 10V = 0 – the maximum flow rate

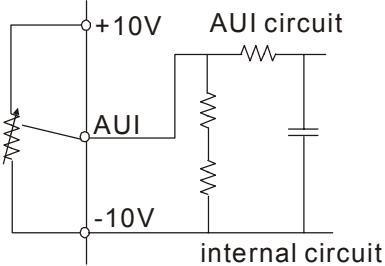
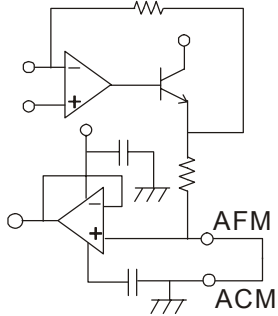
Terminal	Features	Factory Setting (NPN Mode)
AUI	Analog Voltage 	Impedance: 11.3kΩ Resolution: 12 bits Range: -10 ~ +10VDC
+10V	Power supply for configuration	Power supply for analog configuration +10Vdc 20mA (variable resistance 3~5kΩ)
+24V	Power supply terminal for the pressure sensor	Power supply for the pressure sensor +24Vdc 100mA
AFM		Impedance: 16.9kΩ (voltage output) Output current: 20mA max Resolution: 0 – 10V for the maximum operating frequency Range: 0 – 10V Function Setting: Parameter 00-05
ACM	Common ground for analog control signals	Common ground terminal for analog control signals

* Specifications of analog control signal wire: 18 AWG (0.75 mm²), with shielded twisted pair

Analog Input Terminals (PO, PI, QI, AUI, ACM)

- ☑ The maximum input voltage of PI, PO, and QI cannot exceed +12V and no more than +/-12V for AUI. Otherwise, the analog input function may become ineffective.
- ☑ Analog input signals are easily affected by external noise. Use shielded wiring and keep it as short as possible (<20m) with proper grounding. If the noise is inductive, connecting the shield to terminal ACM can bring improvement.
- ☑ If the analog input signals (pressure sensor) are affected by noise from the Hybrid servo drive, please connect a capacitor and ferrite core as indicated in the following diagrams:

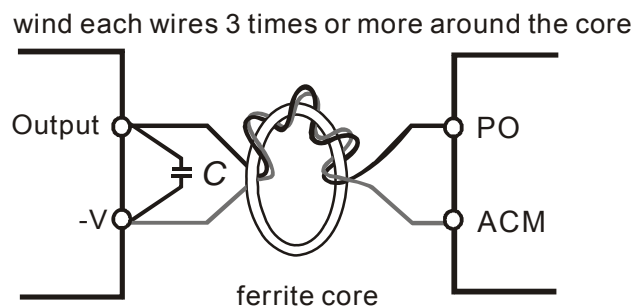

Transistor Output Terminals (MO1, MO2, MCM)

- ☑ Make sure to connect the digital outputs to the right polarity.
- ☑ When connecting a relay to the digital outputs connect a surge absorber across the coil and check the polarity.

3. Machine Adjustment Procedure

3-1 Description of Control Panel

3-2 Machine Adjustment Procedure



CAUTION

- ☑ Please re-check if the wiring is correct before start running the machine. Particularly, make sure that the output terminals of the Hybrid servo drive, U/T1, V/T2, and W/T3, must not be used as power input terminals. Make sure that the good ground terminal ⊕ is grounded.
- ☑ It is not allowed to operate the switches with wet hands.
- ☑ Make sure that there is no short-circuit or ground short circuit conditions between the terminals or exposed live parts.
- ☑ The power switch can be turned on only with the cover installed.



WARNING

- ☑ If any fault occurs during the operation of the Hybrid servo drive and the motor, stop the machine immediately, and refer to “Troubleshooting” to check the cause of the faulty condition. After the Hybrid servo drive stop its output but the main circuit power terminals L1/R, L2/S, and L3/T are not disconnected, if the operator touches the output terminals U/T1, V/T2, and W/T3 of the Hybrid servo drive, electric shock may occur.

3-1 Description of Control Panel

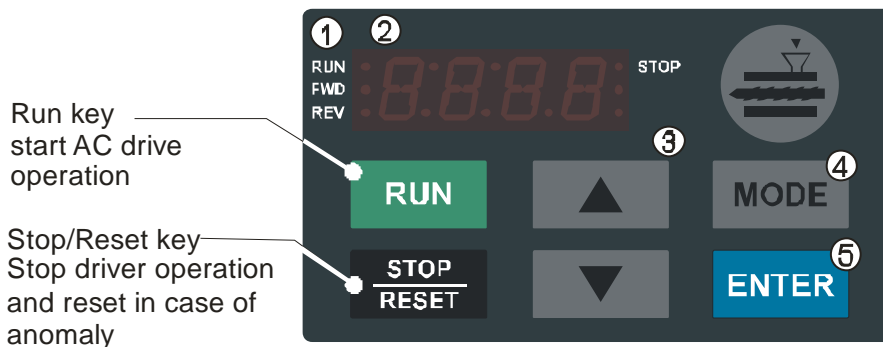

Appearance of Keypad Control Panel KPVJ-LE01



- ① Status Display
Display the driver's current status.
- ② LED Display
Indicates frequency, voltage, current, user defined units and etc.
- ③ UP and DOWN Key
Set the parameter number and changes the numerical data, such as Master Frequency
- ④ MODE
Change between different display mode.
- ⑤ ENTER
Used to enter/modify programming parameters.

Description of Displayed Function Items

Displayed Item	Description
RUN ● FWD ● REV ● F600 ● STOP	The current frequency set for the Hybrid servo drive
RUN ● FWD ● REV ● H500 ● STOP	The frequency Hybrid servo drive actually delivers to the motor
RUN ● FWD ● REV ● U 180 ● STOP	The user-defined physical quantity (Parameter 00-04)
RUN ● FWD ● REV ● A 5.0 ● STOP	Load current
RUN ● FWD ● REV ● Frd ● STOP	Forward command
RUN ● FWD ● REV ● rEv ● STOP	Reverse command
RUN ● FWD ● REV ● 0 100 ● STOP	Displays the selected parameter
RUN ● FWD ● REV ● 10 ● STOP	Display the parameter value
RUN ● FWD ● REV ● EF ● STOP	Display the external fault

	<p>If the “End” message (as shown in the left figure) is displayed on the display area for about one second, it means that data has been accepted and automatically stored in the internal memory</p>
	<p>If the setting data is not accepted or its value exceeds the allowed range, this error message will be displayed</p>

Keypad Panel Operation Procedure

Selecting mode

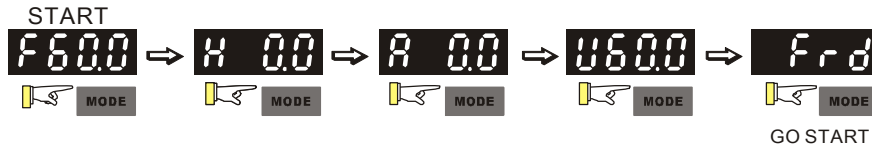

Note: In the selection mode, press  ENTER to set the parameters.

Setting parameters



Note: In the parameter setting mode, you can press  MODE to return the selecting mode.

To modify data



Setting direction

(Operating command is from the digital keypad.)

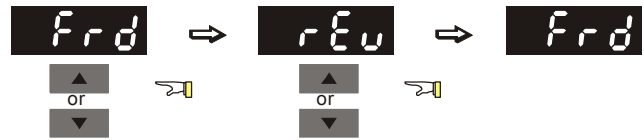

List of Characters Shown on the Seven-segment Display of the Digital Keypad Panel

Numeric	0	1	2	3	4	5	6	7	8	9
Seven-segment Display	0	1	2	3	4	5	6	7	8	9
English Letter	A	a	B	C	c	D	d	E	e	F
Seven-segment Display	A	-	-	C	c	-	d	E	-	F
English Letter	f	G	g	H	h	I	i	J	j	K
Seven-segment Display	-	G	-	H	h	I	i	J	j	K
English Letter	k	L	l	M	m	N	n	O	o	P
Seven-segment Display	-	L	-	M	-	-	n	O	o	P
English Letter	p	Q	q	R	r	S	s	T	t	U
Seven-segment Display	-	-	q	-	r	S	-	T	t	U

English Letter	u	V	v	W	w	X	x	Y	y	Z
Seven-segment Display	—	—	u	—	—	—	—	y	—	≡
English Letter	z									
Seven-segment Display	—									

3-2 Machine Adjustment Procedure

Perform the following operation procedure by using the Digital Keypad (KPVJ-LE01/KPV-CE01)

Step 1. Enter the motor's parameters

- Restore the factory default values by setting the Parameter 00-02 = 10

Reset parameter settings

Setting value of Pr.00-02	10: Reset parameter values
------------------------------	----------------------------

- Please make sure if the command source has been restored to the factory default (operation by external terminals)

If the KPV-CE01 is used, the Parameter is 01-01=0

Source of operation command

Setting value of Pr.01-01	0: Operation by using the digital keypad 1: Operation by using the external terminals. The Stop button on the keypad is disabled. 2: Communication using RS-485. The Stop button on the keypad is disabled
------------------------------	--

- Change the display type from Frequency command (Hz) into Speed (rpm)

Display the speed (rpm) defined by the user

Setting value of Pr. 00-06	0~39999rpm
-------------------------------	------------

- Set the Parameter 01-02

Motor's maximum operation frequency

Setting value of Pr.01-02	50.00 – 600.00Hz
------------------------------	------------------

- Set the Parameter 01-03

Motor's rated frequency

Setting value of Pr.01-03	0.00 – 600.00Hz
------------------------------	-----------------

- Set the Parameters 01-05 & 01-06

Acceleration time setting

Setting value of Pr.01-05	0.00 – 600.00 seconds
------------------------------	-----------------------

Deceleration time setting

Setting value of Pr.01-06	0.00 – 600.00 seconds
------------------------------	-----------------------

The settings for the induction and synchronous motors are different. Please configure these

parameters according to the related adjustment method for the motor.

Induction motor

- Set the Parameter 01-00 = 0

Control mode

Setting value of Pr. 01-00	0: VF
	1: Reserved
	2: Reserved
	3: FOC vector control + Encoder (FOCPG)
	4: Reserved
	5: FOCPM
	6: Reserved

- Set the Parameter 01-26 = 0

Encode type

Setting value of Pr.01-26	0: ABZ
	1: ABZ+HALL (only used for Delta's servo motors)
	2: ABZ+HALL
	3: Resolver

- Set the Parameter 01-29

Number of pulses for each revolution of the encoder

Setting value of Pr. 01-29	1~20000
----------------------------	---------

- Set the Parameter 01-08

The rated current of the induction motor

Setting value of Pr. 01-08	0~655.35 Amps
----------------------------	---------------

- Set the Parameter 01-09

The rated power of the induction motor

Setting value of Pr.01-09	0.00 – 655.35kW
---------------------------	-----------------

- Set the Parameter 01-10

The rated speed (rpm) of the induction motor

Setting value of Pr.01-10	0~65535
---------------------------	---------

- Set the Parameter 01-11

Number of poles of the induction motor

Setting value of Pr. 01-11	2~20
----------------------------	------

- Check if the motor can be separated from the pump
 1. If it can be separated, set the Parameter 01-07 as 1 and carry out a dynamic measurement
 2. If it cannot be separated, open the safety valve, enter the no-load current of the induction

motor 01-12 and set the Parameter 01-07 as 2. Then carry out the static measurement
Motor Parameter Auto Tuning

Setting value of 0:	No function
Pr. 01-07	1: Rolling test for induction motor(IM) (Rs, Rr, Lm, Lx, no-load current)
	2: Static test for induction motor(IM)
	3: Reserved
	4: Auto measure the angle between magnetic pole and PG origin
	5: Rolling test for PM motor

- During the automatic measurement process of the induction motor, the digital keypad will show the message “tun”. After the measurement is finished, the motor automatically shuts down, and the measurement values are stored into Parameters 01-13 to 01-16. If the digital keypad shows “AUE”, please check if the wiring is correct and if the parameters are set correctly.
- The machine will shut off the power and then supply the power again
- Set the Parameter 01-00 = 3

Control mode

Setting value	0: VF
of Pr. 01-00	1: Reserved
	2: Reserved
	3: FOC vector control + Encoder (FOCPG)
	4: Reserved
	5: FOCPM
	6: Reserved

- Test run
When the motor is in a no-load state, the speed command is set to 10 rpm for low-speed test run. Make sure that the output current value is close to the no-load current.
If no error occurs, gradually increase the value of speed command to the highest speed.
- Make sure that the pump's oil supply direction is the forward direction of the motor.

Synchronous motor

- Set the Parameter 01-00 = 5

Control mode

Setting value	0: VF
of Pr.01-00	1: Reserved
	2: Reserved
	3: FOC vector control + Encoder (FOCPG)
	4: Reserved
	5: FOCPM
	6: Reserved

- Set the Parameter 01-26 = 3

Encode type

Setting value	0: ABZ
of Pr. 01-26	1: ABZ+HALL (only used for Delta's servo motors)
	2: ABZ+HALL
	3: Resolver

- Set the Parameter 01-29

Number of pulses for each revolution of the encoder

Setting value	1~20000
of Pr.01-29	

- Set the Parameter 01-17

The rated current of the synchronous motor

Setting value	0~655.35 Amps
of Pr.01-17	

- Set the Parameter 01-18

The rated power of the synchronous motor

Setting value	0.00 – 655.35kW
of Pr.01-18	

- Set the Parameter 01-19

The rated speed (rpm) of the synchronous motor

Setting value	0~65535
of Pr.01-19	

- Set the Parameter 01-20

Number of poles of the synchronous motor

Setting value	2~20
of Pr. 01-20	

- Set the Parameter 01-21

The inertia of the synchronous motor's rotor

Setting value	0.0~6553.5 *10 ⁻⁴ kg.m ²
of Pr.01-21	

- Check if the motor can be separated from the pump
- If it can be separated, set the Parameter 01-07 as 5 and carry out the parameter measurement of the synchronous motor
- If it cannot be separated, open the safety valve, set the Parameter 01-07 as 5 and carry out the parameter measurement of the synchronous motor

Motor Parameter Auto Tuning

Setting value	0: No function
of Pr.01-07	1: Rolling test for induction motor(IM) (Rs, Rr, Lm, Lx, no-load current)
	2: Static test for induction motor(IM)
	3: Reserved

- | |
|---|
| 4: Auto measure the angle between magnetic pole and PG origin |
| 5: Rolling test for PM motor |

- During the automatic measurement process of the synchronous motor, the digital keypad will show the message “tun”. After the measurement is finished, the motor automatically shuts down, and the measurement values are stored into Parameters 01-22 to 01-25. If the digital keypad shows “AUE”, please check if the wiring is correct and if the parameters are set correctly.
- Set the value of Parameter 01-07 as 4 and press [Run]. When the operation is complete, the PG offset angle of PM motor is written to Parameter 01-27

Motor Parameter Auto Tuning

Setting value	0: No function
of Pr.01-07	1: Rolling test for induction motor(IM) (Rs, Rr, Lm, Lx, no-load current)
	2: Static test for induction motor(IM)
	3: Reserved
	4: Auto measure the angle between magnetic pole and PG origin
	5: Rolling test for PM motor

- The machine will shut off power and then supply power again
- Test run
When the motor is in a no-load state, the speed command is set to 10 rpm for low-speed test run. Make sure that the output current value is close to the zero current.
If no error occurs, gradually increase the value of speed command to the highest speed.
Make sure that the pump’s oil supply direction is the forward direction of the motor.

Step 2. Estimation of Inertia

- Set the speed command as 1000 rpm
- Set the Parameters 01-05 & 01-06 = 0.3~0.5 seconds

Acceleration time setting

Setting value	0.00 – 600.00 seconds
of Pr.01-05	

Deceleration time setting

Setting value	0.00 – 600.00 seconds
of Pr. 01-06	

- Set the Parameter 01-31 = 2 and then press [Run]

System control

Setting value	0: No function
of Pr.01-31	1: ASR automatic tuning
	2: Estimation of inertia

- Check if the value of Parameter 01-32 is converged. If it is converged, stop the operation. If not, switch the rotation direction after the speed is stable.

The unity value of the system inertia

Setting value of Pr. 01-32	1~65535 (256 = 1 per unit)
-------------------------------	----------------------------

- After the operation stops, select the Parameter 01-32 and press the [PROG/DATA] button to complete the “write” operation.
- Set Parameter 01-31=1 and the estimation of the motor’s inertia is complete.

Step 3. Connect the motor and the pump and then confirm the pressure feedback signal

- Set the Parameter 00-04 = 11 and then supply voltage to PO

Selection of multi-function display

Setting value of Pr. 00-04	11: display the signal value of the analog input terminal PO with 0~10V mapped to 0~100%
-------------------------------	---

- Parameter 00-08 = related pressure setting value of the pressure sensor at 10V

Maximum pressure feedback value

Setting value of Pr.00-08	0~250Bar
------------------------------	----------

- Set the speed command as 10rpm and press [RUN] to confirm if the pressure value through the pressure gauge > 0.

If the pressure value ≤ 0

- Gradually increase the rotation speed
- Confirm the operation direction of the pump
- Make sure that the direction valve is in the close state

If the pressure value > 0

- Make sure the multi-function display on the keypad panel shows the voltage indicating the same pressure as the pressure gauge

Example: If the pressure sensors indicates 250bar at 10V, when the pressure gauge shows 50 bar, the pressure sensor output voltage should be around $50/250 * 10 = 2V$, and the voltage shown on the keypad panel should be 20.0 (%)

- Observe if there is oil leakage.

Step 4. Confirm the pressure command and flow command

- Parameter 00-09 = 1 for pressure control mode

Pressure control mode

Setting value of Pr. 00-09	0: Speed control 1: Pressure control
-------------------------------	---

- Parameter 00-04 = 12 PI for input voltage

Selection of multi-function display

Setting value of Pr.00-04	12: display the signal value of the analog input terminal PI with 0~10V mapped to 0~100%
------------------------------	---

- Parameter 00-07 = related pressure value of the pressure command at 10V

Maximum pressure command

Setting value of Pr. 00-07	0~250Bar
-------------------------------	----------

- Send the maximum pressure command through the controller and then check the multi-function display page to enter this value into Parameter 00-14
- Send a half pressure command through the controller and then check the multi-function display page to enter this value into Parameter 00-15
- Send the minimum pressure command through the controller and then check the multi-function display page to enter this value into Parameter 00-16

Example: If the pressure sensor indicates 250bar at 10V. If the maximum pressure on the controller is 140bar and corresponds to 10V, then Parameter 00-07=140.

Set the pressure as 140bar through the controller, the voltage value shown on the display is about 56.0 (140/250 * 100%). Enter this value into the Parameter 00-14. Then set the pressure as 70bar on the controller, and now the value displayed on the keypad panel is about 28.0 (70/250 * 100%). Enter this value to the Parameter 00-15. Then set the pressure as 0 bar on the controller, and the voltage value shown on the display is about 0.0 (0/250 * 100%). Enter this value in the Parameter 00-16.

- Parameter 00-04 = 25 for QI input voltage

Selection of multi-function display

Setting value of Pr. 00-04	25: display the signal value of the analog input terminal OI with 0~10V mapped to 0~100%
-------------------------------	---

- Send the 100% flow rate through the controller and then check the multi-function display page to enter this value into Parameter 00-17
- Send the 50% flow rate through the controller and then check the multi-function display page to enter this value into Parameter 00-18
- Send the 0% flow rate through the keypad panel and then check the multi-function display page to enter this value into 00-19

Step 5. Bleed the circuit and make sure if there is any plastic material in the barrel. The machine can start operation only when there are no plastic materials inside the barrel.

- Parameter 00-09 = 1 for pressure control mode

Pressure control mode

Setting value of Pr. 00-09	0: Speed control 1: Pressure control
-------------------------------	---

- Set the Parameters 01-05 & 01-06 = 0 second

Acceleration time setting

Setting value of Pr. 01-05	0.00 – 600.00 seconds
-------------------------------	-----------------------

Deceleration time setting

Setting value	0.00 – 600.00 seconds
---------------	-----------------------

- For low-pressure and low-speed conditions (within 30% of the rated values), use the “manual operation” through the controller for the operation of each cylinder. During the operation, check the pipe connection for leaks or strange noise in the pump.
- When the air is bleeding completely, if there is any pressure fluctuation during operation, please adjust the pressure control Parameter PI in accordance with the method described in the “Description of Parameters”.

Step 6. Send operation command through the controller

- Parameter 01-01=1

Source of operation command

Setting value of Pr. 01-01	0: Operation by using the digital keypad
	1: Operation by using the external terminals. The Stop button on the keypad is disabled.
	2: Communication using RS-485. The Stop button on the keypad is disabled

Step 7. Adjustment for injection/pressure holding

- Heat up the barrel to the required temperature and set the controller in manual control mode.
- Set the Ki values for the three stages PI to 0 (Parameters 00-21, 00-23 , and 00-25) and Kp values to small values (≤ 50.0)
- Start the plastic injection operation. The “Target value” is low pressure ($< 50\text{Bar}$) and low flow rate ($< 30\%$) .
- Press the “injection” button on the operation panel for the injection operation or the machine will enter the pressure holding operation (depending on the position of the cylinder)
- In the pressure holding state without causing the vibration of the motor, increase the speed bandwidth to the maximum value 40Hz (Parameter 00-10).
- In the pressure holding condition, if the pointer of the pressure gauge or the monitored pressure waveform has no fluctuation, it means that the pressure is stably fed back. It is allowed to increase the three Kp values.
- When the pressure feedback becomes unstable, reduce the three Kp values by 20% (example: the three Kp values are reduced from 100.0 to 80.0). Adjust the three Ki values to eliminate the steady-state error so as to speed up system response.
- When the above steps are completed, increase the "target value" for the pressure command.
- Observe if the pressure feedback is stable. If there is an abnormal condition, please solve it as follows:

Solve the pressure instability problem

Instability at high pressure

If the Hybrid servo drive has an overload condition, please increase the power rating of the

Hybrid servo drive

Instability over the entire pressure range

1. Set Parameter 00-09 = 0 to switch to the speed control
2. If the hydraulic circuit is in the closed state, send a low speed command so as to allow a pressure feedback value of 40-50% of the value for pressure command (parameters 00-07)
3. By using the monitoring software, observe if the pressure waveform has irregular fluctuations.

- Pressure waveform fluctuates

It may be a ground interference problem. If the motor or the three-phase power supply is grounded, disconnect the ground wire. If the motor or three-phase power supply has no ground wire, you can install a ground wire for anti-interference protection.

It may be a grounding problem of the shield mesh (as the red thick line shown below). If the shield mesh is properly grounded, the ground wire can be removed; if the shield mesh has no grounding wire, install a ground wire for anti-interference protection.

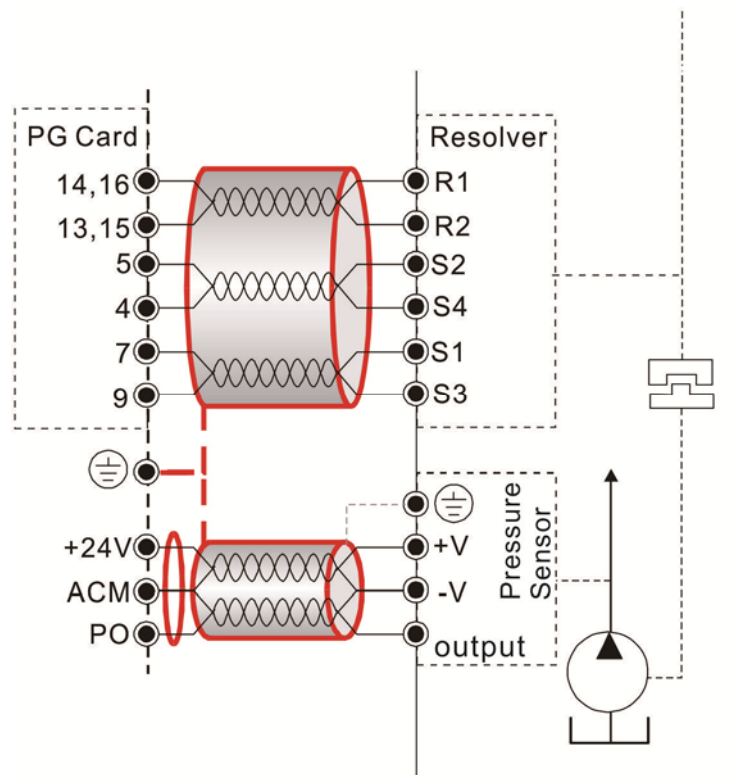

4. If there is any abnormal condition that can not be solved, please contact the manufacturer.

Step 8. Adjustment of system transient response

- Reduce the pressure rise time, increase Kp1 (Parameter 00-20) and reduce the Ki1 time (Parameter 00-21)

- For pressure overshoot, increase the Kp3 time (Parameter 00-24) and reduce the Ki3 time (Parameter 00-25)

Confluence Machine Tuning Procedure

Wiring according to Chapter 2

Carry out the automatic measurement of the motor's parameters according to Step 1 and Step 2 described above for the Master and Slave, respectively. Then perform the following procedure

Master setting

- Set the Parameter 03-06 = 1

Multifunction Output 2 (MO1)

Setting value of Pr. 03-06	1: Operation indication
-------------------------------	-------------------------

- Connect the Master's MO1 output terminal to the Slave's SON terminal and Master's MCM terminal to the Slave's COM terminal.
- For the firmware version 2.03 and above, it is not necessary to perform the two steps described above

- Set the Parameter 03-13 = 1

Confluence Master/Slave Selection

Setting value of Pr. 03-13	0: No function
	1: Master 1
	2: Slave/Master 2
	3: Slave/Master 3

- Set the Parameter 03-14
- Slave's proportion of the Master's flow

Setting value of Pr. 03-14	0.0~6553.5%
-------------------------------	-------------

- For firmware version 2.03 and above, the Parameter 03-17 can be configured to determine the activation level for the Slave

Slave's activation level

Setting value of Pr. 03-17	0~100%
-------------------------------	--------

Slave setting

- Parameter 01-01=1

Source of operation command

Setting value of Pr. 01-01	0: Operation by using the digital keypad
	1: Operation by using the external terminals. The Stop button on the keypad is disabled.

2: Communication using RS-485. The Stop button on the keypad is disabled

- For firmware version 2.03 and above, set the Parameter 01-01=2

Source of operation command

Setting value	0: Operation by using the digital keypad
of Pr. 01-01	1: Operation by using the external terminals. The Stop button on the keypad is disabled.
	2: Communication using RS-485. The Stop button on the keypad is disabled

- Set the Parameter 03-15 = 1

Source of Frequency Command

Setting value	0: Digital Operation Panel
of Pr. 03-15	1: RS485 Communication
	2~5: reserved

- Shut down the power and then supply the power again
Set an arbitrary value of the frequency command at the Master to check if the Slave has the same value of the frequency command
Set 10rpm at the Master and then press RUN to see if the Slave is also running. If not, check the wiring or the parameter setting for any problem
- Set the Slave Parameter 03-13 = 2

Confluence Master/Slave Selection

Setting value	0: No function
of Pr. 03-13	1: Master 1
	2: Slave/Master 2
	3: Slave/Master 3

- For firmware version 2.03 and above, the Parameter 03-21 can be set at the Slave to decide if the Slave is performing the reversed operation for depressurization.
Note: If it is required to reverse the operation for depressurization at the Slave, it is necessary to make sure that the pump outlet port is not installed with a check valve and the Parameter 03-16 should be set as 500%

Slave reverse operation for depressurization

Setting value	0: Disable
of Pr.03-21	1: Enable

Limit for the Slave reverse depressurization torque

Setting value	0~500%
of Pr. 03-16	

- Shut off the power and the re-supply power for the Slave, and then set the Slave in the speed

control mode

Speed Control Mode

Setting value	0: Speed control
of Pr. 00-09	1: Pressure control

In this case, the Master can be tuned according to the Step 3 – Step 8 described above

Confluence/Diversion Mode Adjustment Procedure

Wiring according to Chapter 2

In a diversion condition, adjust various parameters of the Hybrid servo drive according to the Step 1 – Step 8 describe above

In a confluence condition, please refer to the machine adjustment procedure for the confluence operation

Complete the above steps

Set the Master for pressure control mode

- Parameter 00-09 = 1 for pressure control mode

Pressure control mode

Setting value	0: Speed control
of Pr. 00-09	1: Pressure control

Set the Slave for speed control mode

- Parameter 00-09 = 0 for speed control mode

Speed Control Mode

Setting value	0: Speed control
of Pr.00-09	1: Pressure control

Respectively set the master/slave multi-function input state. For the firmware version 2.03 and above, it is necessary to set these parameters for the Slave only

- Parameter 03-00~03-02 = 45 confluence/diversion signal input

Multi-function Input

Setting values	0: No function
of Pr.	45: Confluence/Diversion signal input
03-00~03-02	

- Through the controller, perform the entire confluence/diversion operation.

4. Description of Parameters

4-1 Summary of Parameters

4-2 Detailed Description of Parameters

4-1 Summary of Parameters

00 System Parameters

↗ the parameter can be set during operation

Parameter code	Function of the parameter	Settings	Default value	VF	FOCPG	FOCPM
00-00	Hybrid servo drive model code ID	12 : 230V, 7.5HP 13 : 460 V, 7.5HP 14 : 230V, 10HP 15 : 460V, 10HP 16 : 230V, 15HP 17 : 460V, 15HP 18 : 230V, 20HP 19 : 460V, 20HP 20 : 230V, 25HP 21 : 460V, 25HP 22 : 230V, 30HP 23 : 460V, 30HP 24 : 230V, 40HP 25 : 460V, 40HP 26 : 230V, 50HP 27 : 460V, 50HP 29 : 460V, 60HP 31 : 460V, 75HP 33 : 460V, 100HP	Read only	○	○	○
00-01	Display of rated current of the Hybrid servo drive	Display the model specific values	Read only	○	○	○
00-02	Reset parameter settings	5: Rest the kWh at drive stop 10: Reset parameter values	0	○	○	○
00-03	Software version	Read only	Read only	○	○	○
↗ 00-04	Selection of multi-function display	0: Display the output current (A) 1: Reserved 2: Display the actual output frequency (H) 3: Display the DC-BUS voltage (U) 4: Display the output voltage (E) 5: Display the output power angle (n) 6: Display the output power in kW (P) 7: Display the actual motor speed rpm (r) 8: Display the estimated output torque (%) 9: Display the PG feedback (G) 10: Reserved 11: Display the signal value of the analog input terminal PO % (1.) 12: Display the signal value of the analog input terminal PI % (2.) 13: Display the signal value of the analog input terminal AUI % (3.) 14: Display temperature of the heat sink in °C (t.) 15: Display temperature of IGBT in °C (T) 16: The status of digital input (ON/OFF) (i) 17: The status of digital output (ON/OFF) (o) 18: Reserved 19: The corresponding CPU pin status of the digital input (i.) 20: The corresponding CPU pin status of the digital output (o.) 21~24: Reserved 25: Display the signal value of the analog input terminal QI % (5.) 26: Display the actual pressure value (Bar) (b.) 27: Display the kWh value (K) 28: Display the motor temperature (currently only support KTY84) (T.)	0	○	○	○

Parameter code	Function of the parameter	Settings	Default value	VF	FOCPG	FOCPM	
/	Analog output function selection	0: Output frequency (Hz)	0	<input type="radio"/>	<input type="radio"/>	<input type="radio"/>	
		1: Frequency command (Hz)		<input type="radio"/>	<input type="radio"/>	<input type="radio"/>	
		2: Motor speed (Hz)		<input type="radio"/>	<input type="radio"/>	<input type="radio"/>	
		3: Output current (A)		<input type="radio"/>	<input type="radio"/>	<input type="radio"/>	
		4: Output voltage		<input type="radio"/>	<input type="radio"/>	<input type="radio"/>	
		5: DC Bus voltage		<input type="radio"/>	<input type="radio"/>	<input type="radio"/>	
		6: Power factor		<input type="radio"/>	<input type="radio"/>	<input type="radio"/>	
		7: Power		<input type="radio"/>	<input type="radio"/>	<input type="radio"/>	
		8: Output torque		<input type="radio"/>	<input type="radio"/>	<input type="radio"/>	
		9: PO		<input type="radio"/>	<input type="radio"/>	<input type="radio"/>	
		10: PI		<input type="radio"/>	<input type="radio"/>	<input type="radio"/>	
		11: AUI		<input type="radio"/>	<input type="radio"/>	<input type="radio"/>	
	12~20: Reserved	<input type="radio"/>	<input type="radio"/>	<input type="radio"/>			
00-06	Display the speed (rpm) defined by the user	0~39999 rpm	2500	<input type="radio"/>	<input type="radio"/>	<input type="radio"/>	
/	00-07	Maximum value for the pressure command	0~400Bar	140	<input type="radio"/>	<input type="radio"/>	<input type="radio"/>
/	00-08	Maximum pressure feedback value	0~400 Bar	250	<input type="radio"/>	<input type="radio"/>	<input type="radio"/>
	00-09	Pressure control mode	0: Speed control 1: Pressure control	0	<input type="radio"/>	<input type="radio"/>	<input type="radio"/>
	00-10	Speed bandwidth	0~40Hz	20	<input type="radio"/>	<input type="radio"/>	<input type="radio"/>
/	00-11	Pressure feedback filtering time PO	0.000~1.000 second	0.000	<input type="radio"/>	<input type="radio"/>	<input type="radio"/>
/	00-12	Pressure command filtering time PI	0.000~1.000 second	0.000	<input type="radio"/>	<input type="radio"/>	<input type="radio"/>
/	00-13	Flow command filtering time QI	0.000~1.000 second	0.000	<input type="radio"/>	<input type="radio"/>	<input type="radio"/>
/	00-14	Percentage for the pressure command value (Max)	0.0~100.0%	56.0	<input type="radio"/>	<input type="radio"/>	<input type="radio"/>
/	00-15	Percentage for the pressure command value (Mid)	0.0~100.0%	28.0	<input type="radio"/>	<input type="radio"/>	<input type="radio"/>
/	00-16	Percentage for the pressure command value (Min)	0.0~100.0%	0.0	<input type="radio"/>	<input type="radio"/>	<input type="radio"/>
/	00-17	Percentage for the flow command value (Max)	0.0~100.0%	100.0	<input type="radio"/>	<input type="radio"/>	<input type="radio"/>
/	00-18	Percentage for the flow command value (Mid)	0.0~100.0%	50.0	<input type="radio"/>	<input type="radio"/>	<input type="radio"/>

Parameter code	Function of the parameter	Settings	Default value	VF	FOCPG	FOCPM
00-19	Percentage for the flow command value (Min)	0.0~100.0%	0.0	<input type="radio"/>	<input type="radio"/>	<input type="radio"/>
00-20	P gain 1	0.0~1000.0	50.0	<input type="radio"/>	<input type="radio"/>	<input type="radio"/>
00-21	I integration time 1	0.00~500.00 seconds	2.00	<input type="radio"/>	<input type="radio"/>	<input type="radio"/>
00-22	P gain 2	0.0~1000.0	50.0	<input type="radio"/>	<input type="radio"/>	<input type="radio"/>
00-23	I integration time 2	0.00~500.00 seconds	2.00	<input type="radio"/>	<input type="radio"/>	<input type="radio"/>
00-24	P gain 3	0.0~1000.0	50.0	<input type="radio"/>	<input type="radio"/>	<input type="radio"/>
00-25	I integration time 3	0.00~500.00 seconds	2.00	<input type="radio"/>	<input type="radio"/>	<input type="radio"/>
00-26	Pressure stable region	0~100%	25	<input type="radio"/>	<input type="radio"/>	<input type="radio"/>
00-27	Base pressure	0.0~100.0%	0.1	<input type="radio"/>	<input type="radio"/>	<input type="radio"/>
00-28	Depressurization speed	0~100%	25	<input type="radio"/>	<input type="radio"/>	<input type="radio"/>
00-29	Ramp up rate of pressure command	0~1000ms	0	<input type="radio"/>	<input type="radio"/>	<input type="radio"/>
00-30	Ramp down rate of pressure command	0~1000ms	100	<input type="radio"/>	<input type="radio"/>	<input type="radio"/>
00-31	Ramp up rate of flow command	0~1000 ms	80	<input type="radio"/>	<input type="radio"/>	<input type="radio"/>
00-32	Ramp down rate of flow command	0~1000 ms	80	<input type="radio"/>	<input type="radio"/>	<input type="radio"/>
00-33	Valve opening delay time	0~200 ms	0	<input type="radio"/>	<input type="radio"/>	<input type="radio"/>
00-34	Reserved					
00-35	Over-pressure detection level	0~400Bar	230	<input type="radio"/>	<input type="radio"/>	<input type="radio"/>
00-36	Detection of disconnection of pressure feedback	0 : No function 1: Enable (only for the pressure feedback output signal within 1~5V and 4~20mA)	0	<input type="radio"/>	<input type="radio"/>	<input type="radio"/>
00-37	Differential gain	0.0~100.0 %	0.0	<input type="radio"/>	<input type="radio"/>	<input type="radio"/>
00-38	Pressure/flow control function selection	Bit 0: 0: Switch the PI Gain according to the pressure feedback level 1: Switch the PI Gain according to the multi-function input terminal Bit 1: 0: No pressure/flow control switch 1: Switch between the pressure and flow control	0	<input type="radio"/>	<input type="radio"/>	<input type="radio"/>
00-39	I gain of Pressure overshoot 1	0.00~500.00 sec.	0.2	<input type="radio"/>	<input type="radio"/>	<input type="radio"/>
00-40	Reserved					
00-41	Reserved					
00-42	Pressure overshoot level	0~100%	2	<input type="radio"/>	<input type="radio"/>	<input type="radio"/>
00-43	Maximum Flow	0~100%	100	<input type="radio"/>	<input type="radio"/>	<input type="radio"/>

Parameter code	Function of the parameter	Settings	Default value	VF	FOCPG	FOCPM
00-44	Pressure Command	0~400 bar	0	<input type="radio"/>	<input type="radio"/>	<input type="radio"/>
00-45	Flow Command	0~100%	0	<input type="radio"/>	<input type="radio"/>	<input type="radio"/>
00-46	Pressure reference S1 time	0~1000ms	0	<input type="radio"/>	<input type="radio"/>	<input type="radio"/>
00-47	Pressure reference S2 time	0~1000ms	0	<input type="radio"/>	<input type="radio"/>	<input type="radio"/>
00-48	Flow reference S1 time	0~1000ms	0	<input type="radio"/>	<input type="radio"/>	<input type="radio"/>
00-49	Flow reference S2 time	0~1000ms	0	<input type="radio"/>	<input type="radio"/>	<input type="radio"/>

01 Motor Parameters

✎ the parameter can be set during operation

Parameter code	Function of the parameter	Settings	Default value	VF	FOCPG	FOCPM
01-00	Control mode	0: VF 1: Reserved 2: Reserved 3: FOCPG 4: Reserved 5: FOCPM 6: Reserved	5	<input type="radio"/>	<input type="radio"/>	<input type="radio"/>
✎ 01-01	Source of operation command	0: Operation by using the digital keypad 1: Operation by using the external terminals. The Stop button on the keypad is disabled. 2: Communication using RS-485. The Stop button on the keypad is disabled	0	<input type="radio"/>	<input type="radio"/>	<input type="radio"/>
01-02	Motor's maximum operation frequency	50.00~600.00Hz	166.67	<input type="radio"/>	<input type="radio"/>	<input type="radio"/>
01-03	Motor's rated frequency	0.00~600.00Hz	113.33	<input type="radio"/>	<input type="radio"/>	<input type="radio"/>
01-04	Motor's rated voltage	230V Series: 0.1V~255.0V 460V Series: 0.1V~510.0V	220.0 440.0	<input type="radio"/>	<input type="radio"/>	
✎ 01-05	Acceleration time setting	0.00~600.00 seconds	0.00	<input type="radio"/>	<input type="radio"/>	<input type="radio"/>
✎ 01-06	Deceleration time setting	0.00~600.00 seconds	0.00	<input type="radio"/>	<input type="radio"/>	<input type="radio"/>
01-07	Motor Parameter Auto Tuning	0: No function 1: Rolling test for induction motor(IM) (Rs, Rr, Lm, Lx, no-load current) 2: Static test for induction motor(IM) 3: Reserved 4: Auto measure the angle between magnetic pole and PG origin 5: Rolling test for PM motor	0	<input type="radio"/>	<input type="radio"/>	<input type="radio"/>
01-08	Rated current of the induction motor (A)	40~120% of the drive's rated current	###		<input type="radio"/>	
✎ 01-09	Rated power of the induction motor	0~655.35kW	###		<input type="radio"/>	
✎ 01-10	Rated speed of the induction motor	0~65535rpm 1710 (60Hz 4-pole); 1410 (50Hz 4-pole)	1710		<input type="radio"/>	
01-11	Number of poles of the induction motor	2~20	4		<input type="radio"/>	
01-12	No-load current of the induction motor (A)	0~Default value of Parameter 01-08	###		<input type="radio"/>	

Parameter code	Function of the parameter	Settings	Default value	VF	FOCPG	FOCPM
01-13	Stator resistance (Rs) of the induction Motor	0~65.535Ω	#.###		○	
01-14	Rotor resistance (Rr) of the induction Motor	0~65.535Ω	#.###		○	
01-15	Magnetizing inductance (Lm) of the induction Motor	0.0~6553.5mH	##		○	
01-16	Total leakage inductance (Lx) of the induction motor	0.0~6553.5mH	##		○	
01-17	Rated current of the synchronous motor	0~655.35 Amps	0.00			○
01-18	Rated power of the synchronous motor	0.00 – 655.35kW	0.00			○
01-19	Rated speed of the synchronous motor	0~65535rpm	1700			○
01-20	Number of poles of the synchronous motor	2~20	8			○
01-21	Inertia of the synchronous motor's rotor	0.0~6553.5 *10 ⁻⁴ kg.m ²	0.0			○
01-22	Stator's phase resistance (Rs) of the synchronous motor	0.000~65.535Ω	0.000			○
01-23	Stator's phase inductance (Ld) of the synchronous motor	0.00.0~655.35mH	0.00			○
01-24	Stator's phase inductance (Lq) of the synchronous motor	0.00.0~655.35mH	0.00			○
01-25	Back EMF of the synchronous motor	0~65535 V/krpm	0			○
01-26	Encode type	0: ABZ 1: ABZ+HALL (only used for Delta's servo motors) 2: ABZ+HALL 3: Resolver	3			○
01-27	PG Offset angle of synchronous motor	0.0~360.0°	0.0			○
01-28	Number of poles of the resolver	1~5	1			○
01-29	Encoder pulse	1~20000	1024		○	○

Parameter code	Function of the parameter	Settings	Default value	VF	FOCPG	FOCPM
01-30	Encoder's input type setting	0: No function 1: Phase A leads in a forward run command and phase B leads in a reverse run command 2: Phase B leads in a forward run command and phase A leads in a reverse run command 3: Phase A is a pulse input and phase B is a direction input. (low input=reverse direction, high input=forward direction) 4: Phase A is a pulse input and phase B is a direction input. (low input=forward direction, high input=reverse direction) 5: Single-phase input	1		<input type="radio"/>	<input type="radio"/>
01-31	System control	0: No function 1: ASR automatic tuning 2: Estimation of inertia	1		<input type="radio"/>	<input type="radio"/>
01-32	Unity value of the system inertia	1~65535 (256 = 1 per unit)	400		<input type="radio"/>	<input type="radio"/>
01-33	Carrier frequency	5KHz; 10KHz	5	<input type="radio"/>	<input type="radio"/>	<input type="radio"/>
01-34	Reserved					
01-35	Motor ID	0 : No function 16: Delta's Hybrid servo motor ECMA-ER181BP3 (11kW220V) 17: Delta's Hybrid servo motor ECMA-KR181BP3 (11kW380V) 18: Delta's Hybrid servo motor ECMA-ER221FPS (15kW220V) 19: Delta's Hybrid servo motor ECMA-KR221FPS (15kW380V) 20: Delta's Hybrid servo motor ECMA-ER222APS (20kW220V) 21: Delta's Hybrid servo motor ECMA-KR222APS (20kW380V) 114: Hybrid servo motor MSJ-ER0975E28B(7.5kW220V) 115: Hybrid servo motor MSJ-KR0975E28B(7.5kW380V) 125: Hybrid servo motor MSJ-KR133AE48B(30kW380V)	0	<input type="radio"/>	<input type="radio"/>	<input type="radio"/>
01-36	Change the rotation direction	0: When the driver runs forward, the motor rotates counterclockwise. When the driver runs reverse, the motor rotates clockwise. 1: When the driver runs forward, the motor rotates clockwise. When the driver runs reverse, the motor rotates counterclockwise.	0	<input type="radio"/>	<input type="radio"/>	<input type="radio"/>

Parameter code	Function of the parameter	Settings	Default value	VF	FOCPG	FOCPM
01-37	HES ID #	0: non-functional See parameter description	0	<input type="radio"/>	<input type="radio"/>	<input type="radio"/>

0-2 Parameters for Protection











✎ the parameter can be set during operation

Parameter code	Function of the parameter	Settings	Default value	VF	FOCPG	FOCPM
✎ 02-00	Software brake level	230V series: 350.0~450.0Vdc 460V series: 700.0~900.0Vdc	380.0 760.0	<input type="radio"/>	<input type="radio"/>	<input type="radio"/>
02-01	Present fault record	0: No error record	0	<input type="radio"/>	<input type="radio"/>	<input type="radio"/>
02-02	Second most recent fault record	1: Over-current during acceleration (ocA)	0	<input type="radio"/>	<input type="radio"/>	<input type="radio"/>
02-03	Third most recent fault record	2: Over-current during deceleration (ocd)	0	<input type="radio"/>	<input type="radio"/>	<input type="radio"/>
02-04	Fourth most recent fault record	3: Over-current during constant speed (ocn)	0	<input type="radio"/>	<input type="radio"/>	<input type="radio"/>
02-05	Fifth most recent fault record	4: Ground fault (GFF)	0	<input type="radio"/>	<input type="radio"/>	<input type="radio"/>
02-06	Sixth most recent fault record	5: IGBT short-circuit (occ)	0	<input type="radio"/>	<input type="radio"/>	<input type="radio"/>
		6: Over-current at stop (ocS)		<input type="radio"/>	<input type="radio"/>	<input type="radio"/>
		7: Over-voltage during acceleration (ovA)		<input type="radio"/>	<input type="radio"/>	<input type="radio"/>
		8: Over-voltage during deceleration (ovd)		<input type="radio"/>	<input type="radio"/>	<input type="radio"/>
		9: Over-voltage during constant speed (ovn)		<input type="radio"/>	<input type="radio"/>	<input type="radio"/>
		10: Over-voltage at stop (ovS)		<input type="radio"/>	<input type="radio"/>	<input type="radio"/>
		11: Low-voltage during acceleration (LvA)		<input type="radio"/>	<input type="radio"/>	<input type="radio"/>
		12: Low-voltage during deceleration (Lvd)		<input type="radio"/>	<input type="radio"/>	<input type="radio"/>
		13: Low-voltage during constant speed (Lvn)		<input type="radio"/>	<input type="radio"/>	<input type="radio"/>
		14: Low-voltage at stop (LvS)		<input type="radio"/>	<input type="radio"/>	<input type="radio"/>
		15: Phase loss protection (PHL)		<input type="radio"/>	<input type="radio"/>	<input type="radio"/>
		16: IGBT over-heat (oH1)		<input type="radio"/>	<input type="radio"/>	<input type="radio"/>
		17: Heat sink over-heat for 40HP and above (oH2)		<input type="radio"/>	<input type="radio"/>	<input type="radio"/>
		18: TH1 open: IGBT over-heat protection circuit error (tH1o)		<input type="radio"/>	<input type="radio"/>	<input type="radio"/>
		19: TH2 open: heat sink over-heat protection circuit error (tH2o)		<input type="radio"/>	<input type="radio"/>	<input type="radio"/>
		20: IGBT over heated and unusual fan function (oHF)		<input type="radio"/>	<input type="radio"/>	<input type="radio"/>
		21: Hybrid servo drive overload (oL)		<input type="radio"/>	<input type="radio"/>	<input type="radio"/>
22: Motor over-load (EoL1)	<input type="radio"/>	<input type="radio"/>	<input type="radio"/>			
23: Reserved						
24: Motor over-heat, detect by PTC (oH3)	<input type="radio"/>	<input type="radio"/>	<input type="radio"/>			
25: Reserved						
26: Over-torque 1 (ot1)	<input type="radio"/>	<input type="radio"/>	<input type="radio"/>			
27: Over-torque 2 (ot2)	<input type="radio"/>	<input type="radio"/>	<input type="radio"/>			

Parameter code	Function of the parameter	Settings	Default value	VF	FOCPG	FOCPM
		28: Reserved		○	○	○
		29: Reserved		○	○	○
		30: Memory write error (cF1)		○	○	○
		31: Memory read error (cF2)		○	○	○
		32: Isum current detection error (cd0)		○	○	○
		33: U-phase current detection error (cd1)		○	○	○
		34: V-phase current detection error (cd2)		○	○	○
		35: W-phase current detection error (cd3)		○	○	○
		36: Clamp current detection error (Hd0)		○	○	○
		37: Over-current detection error (Hd1)		○	○	○
		38: Over-voltage detection error (Hd2)		○	○	○
		39: Ground current detection error (Hd3)		○	○	○
		40: Auto tuning error (AuE)			○	○
		41: Reserved		○	○	○
		42: PG feedback error (PGF1)			○	○
		43: PG feedback loss (PGF2)			○	○
		44: PG feedback stall (PGF3)			○	○
		45: PG slip error (PGF4)			○	○
		46: Reserved		○	○	○
		47: Reserved		○	○	○
		48: Reserved				
		49: External fault input (EF)		○	○	○
		50: Emergency stop (EF1)		○	○	○
		51: Reserved				
		52: Password error(PcodE)		○	○	○
		53: Reserved		○	○	○
		54: Communication error (cE1)		○	○	○
		55: Communication error (cE2)		○	○	○
		56: Communication error (cE3)		○	○	○
		57: Communication error (cE4)		○	○	○
		58 : Communication time out (cE10)		○	○	○
		59: PU time out (cP10)		○	○	○
		60: Braking transistor error (bF)		○	○	○
		61~63: Reserved		○	○	○
		64: Safety relay Error (SRY)		○	○	○
		65: PG card information error (PGF5)				○
		66: Over pressure (ovP)		○	○	○
		67: Pressure feedback fault (PfbF)		○	○	○

Parameter code	Function of the parameter	Settings	Default value	VF	FOCPG	FOCPM
02-07	Low voltage level	160.0~220.0Vdc 320.0.0~440.0Vdc	180.0 360.0	<input type="radio"/>	<input type="radio"/>	<input type="radio"/>
02-08	PTC action selection	0: Warn and keep operation 1: Warn and ramp to stop 2: Warn and coast to stop	1	<input type="radio"/>	<input type="radio"/>	<input type="radio"/>
02-09	PTC level	0.0~150.0% 0.0~150.0°C	50.0	<input type="radio"/>	<input type="radio"/>	<input type="radio"/>
02-10	PTC detection filtering time	0.00~10.00 seconds	0.20	<input type="radio"/>	<input type="radio"/>	<input type="radio"/>
02-11	PTC type	0: Not assigned 1: KTY84	0	<input type="radio"/>	<input type="radio"/>	<input type="radio"/>
02-12	Motor fan activation level	0.0~100.0% 0.0~150.0°C	50.0	<input type="radio"/>	<input type="radio"/>	<input type="radio"/>
02-13	Electronic thermal relay selection 1	0: Inverter motor 1: Standard motor 2: Disable	2	<input type="radio"/>	<input type="radio"/>	<input type="radio"/>
02-14	Electronic thermal characteristic for motor	30.0~600.0 seconds	60.0	<input type="radio"/>	<input type="radio"/>	<input type="radio"/>
02-15	Output frequency at malfunction	0.00~655.35 Hz	Read only	<input type="radio"/>	<input type="radio"/>	<input type="radio"/>
02-16	Output voltage at malfunction	0.0~6553.5 V	Read only	<input type="radio"/>	<input type="radio"/>	<input type="radio"/>
02-17	DC voltage at malfunction	0.0~6553.5 V	Read only	<input type="radio"/>	<input type="radio"/>	<input type="radio"/>
02-18	Output current at malfunction	0~655.35 Amps	Read only	<input type="radio"/>	<input type="radio"/>	<input type="radio"/>
02-19	IGBT temperature at malfunction	0.0~6553.5 °C	Read only	<input type="radio"/>	<input type="radio"/>	<input type="radio"/>

03 Digital/Analog Input/Output Parameters the parameter can be set during operation

Parameter code	Function of the parameter	Settings	Default value	VF	FOCPG	FOCPM
03-00	Multi-function input command 3 (MI3)	0: No function 44: Injection signal input	0	<input type="radio"/>	<input type="radio"/>	<input type="radio"/>
03-01	Multi-function input command 4 (MI4)	45: Confluence/Diversion signal input 46: Reserved	0	<input type="radio"/>	<input type="radio"/>	<input type="radio"/>
03-02	Multi-function input command 5 (MI5)	47: Multi-level pressure PI command 1 48: Multi-level pressure PI command 2	0	<input type="radio"/>	<input type="radio"/>	<input type="radio"/>
 03-03	Digital input response time	0.001~ 30.000 sec	0.005	<input type="radio"/>	<input type="radio"/>	<input type="radio"/>
 03-04	Digital input operation direction	0~65535	0	<input type="radio"/>	<input type="radio"/>	
 03-05	Multi-function output 1 (Relay 1)	0: No function 1: Operation indication	11	<input type="radio"/>	<input type="radio"/>	<input type="radio"/>
 03-06	Multi-function Output 2 (MO1)	9: Hybrid servo drive is ready 11: Error indication	0	<input type="radio"/>	<input type="radio"/>	<input type="radio"/>
 03-07	Multi-function Output 3 (MO2)	44: Displacement switch signal 45: Motor fan control signal	0	<input type="radio"/>	<input type="radio"/>	<input type="radio"/>
 03-08	Multi-function output direction	0~65535	0		<input type="radio"/>	
 03-09	Low-pass filter time of keypad display	0.001~65.535 seconds	0.010	<input type="radio"/>	<input type="radio"/>	<input type="radio"/>
03-10	Maximum output voltage for pressure feedback	5.0~10.0 V	10.0	<input type="radio"/>	<input type="radio"/>	<input type="radio"/>
03-11	Minimum output voltage for pressure feedback	0.0~2.0 V	0.0	<input type="radio"/>	<input type="radio"/>	<input type="radio"/>
 03-12	Current/Voltage type pressure sensor selection	0: Current type (4mA~20mA) 1: Voltage type	1	<input type="radio"/>	<input type="radio"/>	<input type="radio"/>
03-13	Confluence Master/Slave Selection	0: No function 1: Master 1 2: Slave/Master 2 3: Slave/Master 3	0	<input type="radio"/>	<input type="radio"/>	<input type="radio"/>
03-14	Slave's proportion of the Master's flow	0.0~65535.5 %	100.0	<input type="radio"/>	<input type="radio"/>	<input type="radio"/>
 03-15	Source of frequency command	0: Digital keypad 1: RS485 Communication 2~5: Reserved	0	<input type="radio"/>	<input type="radio"/>	<input type="radio"/>
 03-16	Limit for the Slave reverse depressurization torque	0~500%	20	<input type="radio"/>	<input type="radio"/>	<input type="radio"/>
 03-17	Slave's activation level	0.0~100.0%	50.0	<input type="radio"/>	<input type="radio"/>	<input type="radio"/>

Parameter code	Function of the parameter	Settings	Default value	VF	FOCPG	FOCPM
03-18	Communication error treatment	0: Warn and keep operation 1: Warn and ramp to stop 2: Warn and coast to stop 3: No action and no display	3	<input type="radio"/>	<input type="radio"/>	<input type="radio"/>
03-19	Time-out detection	0.0~100.0 seconds	0.0	<input type="radio"/>	<input type="radio"/>	<input type="radio"/>
03-20	Start-up display selection	0: F (frequency command) 1: H (actual frequency) 2: Multi-function display (user-defined 00-04) 3: A (Output current)	0	<input type="radio"/>	<input type="radio"/>	<input type="radio"/>
03-21	Slave reverse operation for depressurization	0: Disabled 1: Enabled	0	<input type="radio"/>	<input type="radio"/>	<input type="radio"/>

4-2 Detailed Description of Parameters

00 System Parameters

↗ the parameter can be set during operation

00-00 Hybrid servo drive model code ID

Control mode **VF** **FOCPG** **FOCPM**

Factory default: Read only

Settings Read only

00-01 Display of rated current of the Hybrid servo drive

Control mode **VF** **FOCPG** **FOCPM**

Factory default: Read only

Settings Read only



Parameter 00-00 is used to determine the capacity of the Hybrid servo motor which has been configured in this parameter in factory. In addition, the current value of Parameter (00-01) can be read out to check if it is the rated current of the corresponding model. Display value of the current value of Parameter 00-01 for the related Parameter 00-00.

230V Series								
Power (KW)	5.5	7.5	11	15	18.5	22	30	37
Horse Power (HP)	7.5	10	15	20	25	30	40	50
Model ID	12	14	16	18	20	22	24	26

460V Series											
Power (KW)	5.5	7.5	11	15	18.5	22	30	37	45	55	75
Horse Power (HP)	7.5	10	15	20	25	30	40	50	60	75	100
Model ID	13	15	17	19	21	23	25	27	29	31	33

00-02 Reset parameter settings

Control mode **VF** **FOCPG** **FOCPM**

Factory default: 0

Settings 0: No function

5: Rest the kWh at drive stop

10: Reset parameter values



If it is necessary to restore the parameters to factory default, just set this parameter to "10".

00-03 Software version

Control mode **VF** **FOCPG** **FOCPM**

Factory default: ###

Settings Read only

↗ **00-04** Selection of multi-function display

Control mode **VF** **FOCPG** **FOCPM**























Factory default: 0

Settings 0: Display the output current (A)

1: Reserved

2: Display the actual output frequency (H)

3: Display the DC-BUS voltage (U)

4: Display the output voltage (E)	
5: Display the output power angle (n)	
6: Display the output power in kW (P)	
7: Display the actual motor speed(r 00: forward speed; - 00: negative speed)	 
8: Display the estimated output torque (%) (t 0.0: positive torque; - 0.0: negative torque) (%)	 
9: Display the PG feedback (G)	
10: Reserved	
11: Display the signal value of the analog input terminal PO with 0~10V mapped to 0~100%	
12: Display the signal value of the analog input terminal PI with 0~10V mapped to 0~100%	
13: Display the signal value of the analog input terminal PI with -10~10V mapped to 0~100%	
14: Display temperature of the heat sink in °C (t.)	
15: Display temperature of the IGBT power module °C	
16: The status of digital input (ON/OFF)	
17: The status of digital output (ON/OFF)	
18: Reserved	
19: The corresponding CPU pin status of the digital input	
20: The corresponding CPU pin status of the digital output	
21~24: Reserved	
25: Display the signal value of the analog input terminal OI with 0~10V mapped to 0~100%	
26: Display the actual pressure value (Bar)	
27: Display the kWh value	
28: Display the motor temperature (currently only support KTY84)	

 This parameter defines the contents to be displayed in the U page of the digital keypad KPV-CE01 (as shown in the figure).

00-05 Analog output function selection

Control mode VF FOC PG FOC PM

Factory default: 0

Settings 0~20

Summary of functions

Setting Value	Function	Description
0	Output frequency (Hz)	The maximum frequency is 100%
1	Frequency command (Hz)	The maximum frequency is 100%
2	Motor speed (Hz)	600Hz is used as 100%
3	Output current (A)	2.5 times of the rated current of the Hybrid servo

		drive is used as 100%
4	Output voltage	2 times of the rated current of the Hybrid servo drive is used as 100%
5	DC BUS voltage	450V (900V) =100%
6	Power factor	-1.000~1.000=100%
7	Power	Rated power of the drive =100%
8	Output torque	Rated torque =100%
9	PO	(0~10V=0~100%)
10	PI	(0~10V=0~100%)
11	AUI	(-10~10V=0~100%)
12~20	Reserved	

00-06 Display the speed (rpm) defined by the user

Control mode **VF** **FOCPG** **FOCPM**

Factory default: 2500

Settings 0~39999 rpm

 Set the maximum speed of the motor corresponding to the 100% flow.

00-07 Maximum value for the pressure command

Control mode **VF** **FOCPG** **FOCPM**

Factory default: 140

Settings 0~400Bar

 The 0~10V for the pressure command on the controller is mapped to 0~the value of this parameter.

 Firmware version 2.04 and above, maximum value 400Bar, the previous version's maximum allowed value is 250Bar.

00-08 Maximum pressure feedback value

Control mode **VF** **FOCPG** **FOCPM**

Factory default: 250

Settings 0~400Bar

 The 0~10V for the pressure sensor is mapped to 0~the value of this parameter.

00-09 Pressure control mode

Control mode **VF** **FOCPG** **FOCPM**

Factory default: 0

Settings 0: Speed control

1: Pressure control

 This parameter determines the control mode of the Hybrid servo drive. It is recommended to use the speed control at the initial start up. After the motor, pump, pressure sensor, and the entire system are checked without any error, switch to the pressure control mode to enter the process control.

 In pressure control(Pr.00-09=1), it is necessary to set bot Pr.01-05 (Acceleration time setting) and Pr01-06 (Deceleration time setting) as zero, or it will affect the stability of pressure control

00-10 Speed bandwidth

Control mode **FOCPG** **FOCPM**

Factory default: 20

Set the speed response. The larger value indicates the faster response.

↗ **00-11** Pressure feedback filtering time PO

↗ **00-12** Pressure feedback filtering time PI

↗ **00-13** Pressure feedback filtering time QI

Control mode VF FOC PG FOC PM

Factory default: 0.000

Settings 0.000~1.000 seconds

Noises may reside in the analog input signals of the control terminals PO, PI, and QI. The noise may affect the control stability. Use an input filter to eliminate such noise.

If the time constant is too large, a stable control is obtained with poorer control response. If it is too small, a fast response is obtained with unstable control. If the optimal setting is not known, adjust it properly according to the instability or response delay.

↗ **00-14** Percentage for the pressure command value (Max)

Control mode VF FOC PG FOC PM

Factory default: 56.0

Settings 0.0~100.0%

↗ **00-15** Percentage for the pressure command value (Mid)

Control mode VF FOC PG FOC PM

Factory default: 28.0

Settings 0.0~100.0%

↗ **00-16** Percentage for the pressure command value (Min)

Control mode VF FOC PG FOC PM

Factory default: 0.0

Settings 0.0~100.0%

When setting maximum value for the pressure command(Pr.00-07) and maximum pressure feedback value(Pr.00-08), Percentage for the pressure command value(Pr.00-14) and (Pr.00-15) will be revised as well; it cannot be set when pressure command is higher than pressure feedback value.

Pr.00-07 can be changed when the drive is in operation, but it can be set when Pr.00-07 is lower than Pr.00-08.

To set these parameters, it is necessary to set Parameter 00-09 as 1

Parameter 00-04 = 12 for PI input voltage

Send the maximum pressure command through the controller and then check the multi-function display page to enter this value into 00-14

Send a half pressure command through the controller and then check the multi-function display page to enter this value into 00-15

Send the minimum pressure command through the controller and then check the multi-function display page to enter this value into 00-16

Example: If the pressure sensor indicates 250bar at 10V. If the controller's maximum pressure of 140bar corresponds to 10V, then Parameter 00-07=140. Set the pressure as 140bar by using the controller, the voltage value shown on the display is about 56.0 ($140/250 * 100\%$). Enter this value into the Parameter 00-14. Then set the pressure as 70bar on the controller, and now the value displayed on the keypad is about 28.0 ($70/250 * 100\%$). Enter this value to the

Parameter 00-15. Then set the pressure as 0 bar on controller, and the voltage value shown on the keypad is about 0.0 (0/250 * 100%). Enter this value in the Parameter 00-16.

↗	00-17	Percentage for the flow command value (Max)							
	Control mode	VF	FOCPG	FOCPM					Factory default: 100.0
	Settings	0.0~100.0%							
↗	00-18	Percentage for the flow command value (Mid)							
	Control mode	VF	FOCPG	FOCPM					Factory default: 50.0
	Settings	0.0~100.0%							
↗	00-19	Percentage for the flow command value (Min)							
	Control mode	VF	FOCPG	FOCPM					Factory default: 0.0
	Settings	0.0~100.0%							
📖	To set these parameters, it is necessary to set Parameter 00-09 as 1								
📖	Parameter 00-04 = 25 for QI input voltage								
	Send the 100% flow rate through the controller and then check the multi-function display page to enter this value into 00-17								
	Send the 50% flow rate through the controller and then check the multi-function display page to enter this value into 00-18								
	Send the 0% flow rate through the controller and then check the multi-function display page to enter this value into 00-19								
↗	00-20	P gain 1							
↗	00-22	P gain 2							
↗	00-24	P gain 3							
	Control mode	VF	FOCPG	FOCPM					Factory default: 50.0
	Settings	0.0~1000.0							
↗	00-21	I integration time 1							
↗	00-23	I integration time 2							
↗	00-25	I integration time 3							
	Control mode	VF	FOCPG	FOCPM					Factory default: 2.00
	Settings	0.00 – 500.00 seconds							
↗	00-37	Differential gain							
	Control mode	VF	FOCPG	FOCPM					Factory default: 0.0
	Settings	0.0~100.0 %							
↗	00-26	Pressure stable region							
	Control mode	VF	FOCPG	FOCPM					Factory default: 25
	Settings	0~100%							

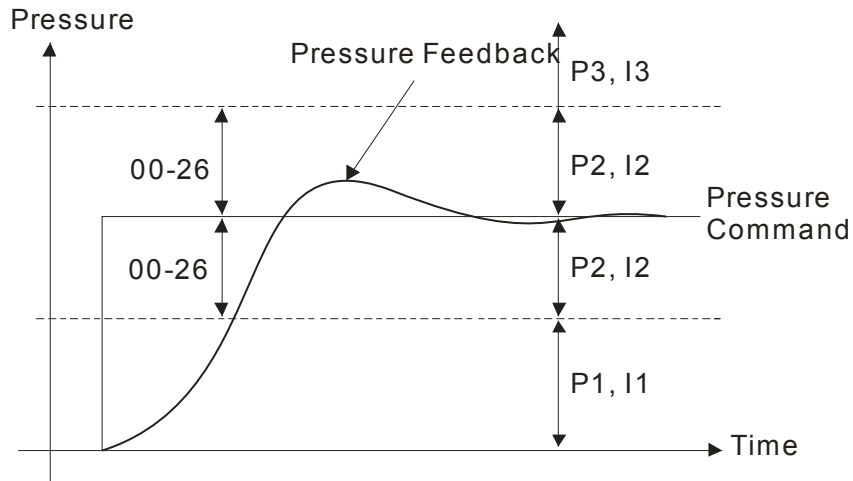

Adjust the Kp value to a proper level first, and then adjust the Ki value (time). If the pressure has overshoot, adjust the kd value.

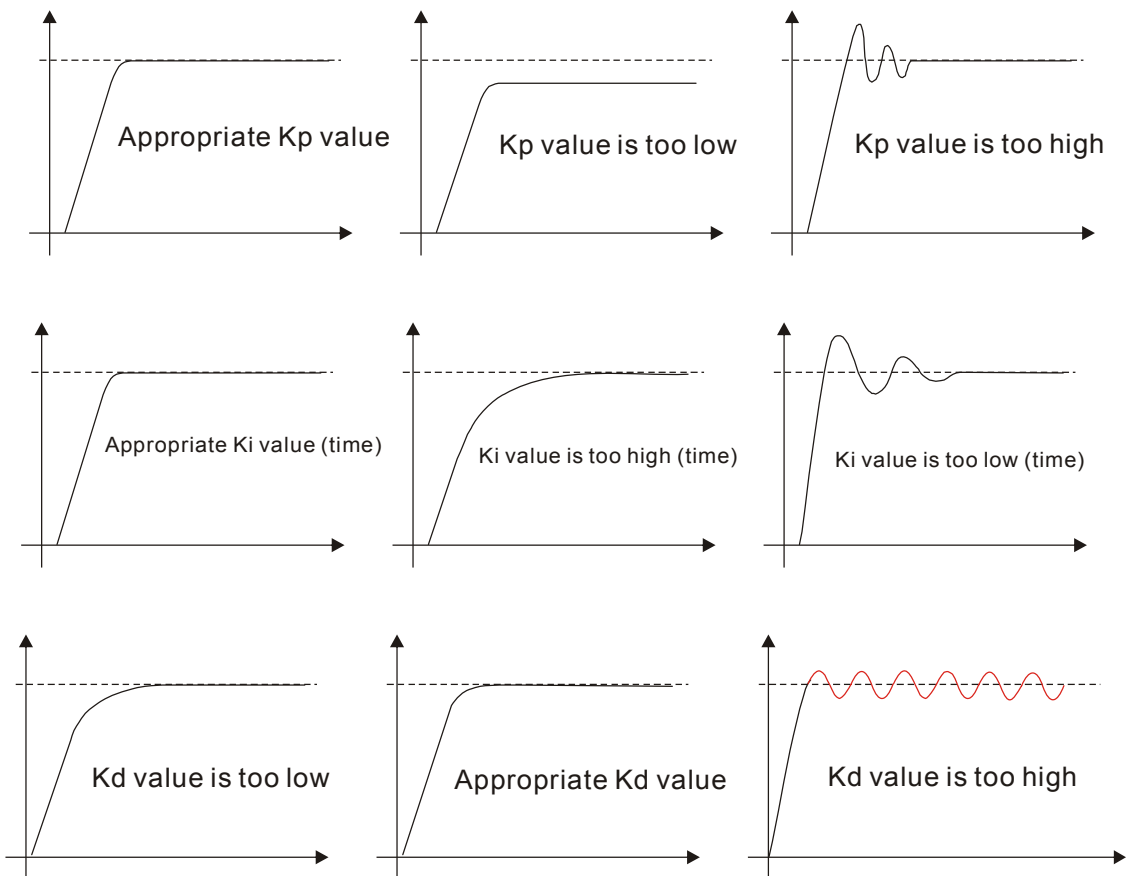

00-27 Base pressure

Control mode VF FOC PG FOC PM

Factory default: 1.0

Settings 0.0~100.0%

- Set the minimum pressure value 100% corresponding to Parameter 00-08
- Typically, it is necessary to maintain a certain base pressure to ensure that the oil pipe is in fully filled condition so as to avoid the activation delay of the cylinder when a pressure/flow command is activated.

00-28 Depressurization speed

Control mode VF FOC PG FOC PM

Factory default: 25

Settings 0~100%

Set the highest rotation speed at depressurization. The 100% value is mapped to Parameter 01-02 (the maximum rotation speed of the motor)

00-29 Ramp up rate of pressure command

Control mode VF FOC PG FOC PM

Factory default: 0

Settings 0~1000ms

00-30 Ramp down rate of pressure command

Control mode VF FOC PG FOC PM

Factory default: 100

Settings 0~1000ms

Ramp the pressure value for the pressure command so as to reduce the vibration of the machine.

Set the time required for ramping the pressure from 0~the maximum pressure (00-08).

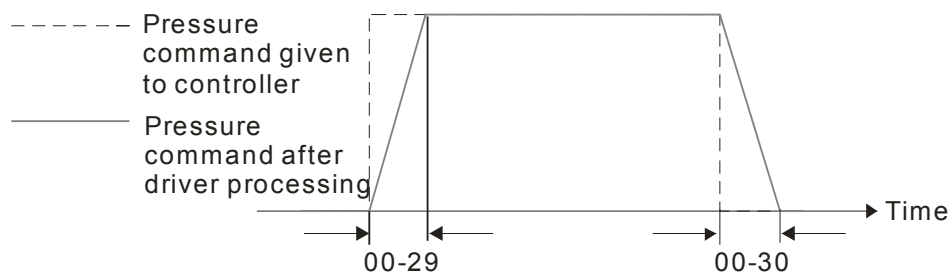

00-31 Ramp up rate of flow command

00-32 Ramp down rate of flow command

Control mode VF FOC PG FOC PM

Factory default: 80

Settings 0~1000ms

Ramp the flow value for the flow command so as to reduce the vibration of the machine.

Set the time required for ramping the flow from 0~the maximum flow (01-02).

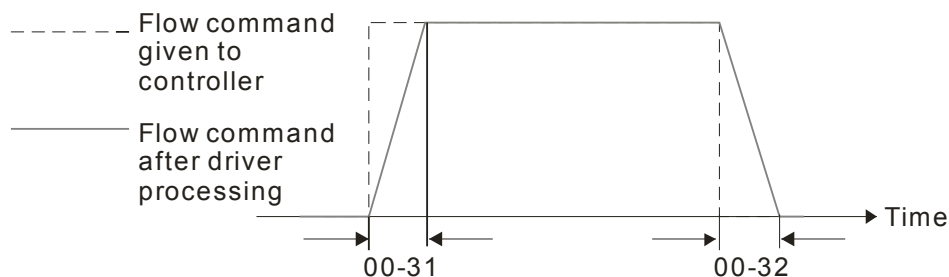

00-33 Valve opening delay time

Control mode VF FOC PG FOC PM

Factory default: 0

Settings 0 – 200ms

When both the pressure command and flow command activate the machine to start from idle, the flow starts to output. However, due to the slower response of the valve in the hydraulic circuit, the sudden surge of the pressure may occur. The pressure may recover to normal till the valve is fully opened. To avoid the aforementioned effect, set this parameter to increase time for the flow output

delay.

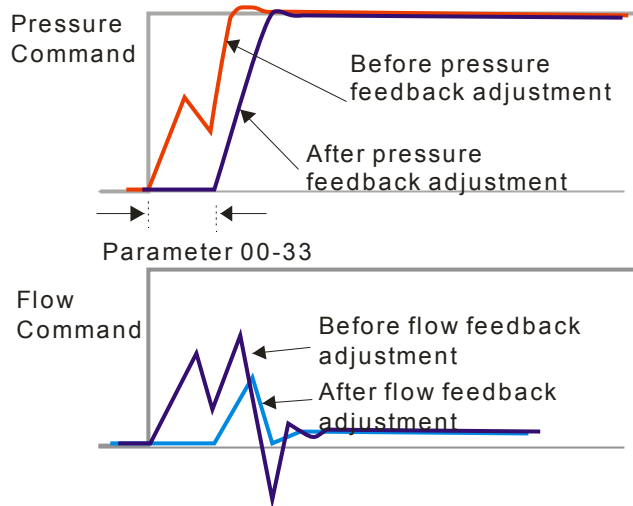

00-34 Reserved

00-35 Over-pressure detection level

Control mode VF FOC PG FOC PM Factory default: 230
 Settings 0~400 Bar

- 📖 When the pressure feedback exceeds this parameter setting, an “ovP over pressure” error message may occur.
- 📖 Firmware version 2.04 and above, maximum value 400Bar, the previous version’s maximum allowed value is 250Bar.

00-36 Detection of disconnection of pressure feedback

Control mode VF FOC PG FOC PM Factory default: 0
 Settings 0: No function

1: Enable (only for the pressure feedback output signal within 1~5V and 4~20mA)

- 📖 When this parameter is set as 1 and if the pressure feedback signal is below 1V, an "Pfbf pressure feedback fault" error message may occur.

00-38 Pressure/flow control function selection

Control mode VF FOC PG FOC PM Factory default: 0

Settings Bit 0:
 0: Switch the PI Gain according to the pressure feedback level
 1: Switch the PI Gain according to the multi-function input terminal
 Bit 1:
 0: No pressure/flow control switch
 1: Switch between the pressure and flow control

- 📖 When the Bit 0 of this parameter is set as 1, the PI Gain for the pressure can be switched in conjunction with the multi-function input terminal

Pr. 03-00~03-02 d= 47	Pr. 03-00~03-02 d= 48	
OFF	OFF	PI1(Parameters 00-20 & 00-21)
ON	OFF	PI2(Parameters 00-22 & 00-23)

OFF	ON	PI3(Parameters 00-24 & 00-25)
-----	----	-------------------------------

When the Bit 1 of this parameter is set as 1, the pressure feedback is lower than the pressure stable region (please refer to the description of Parameter 00-26) so the flow control will be performed. When it enters the pressure stable region, the pressure control will be performed.

00-39 I gain of Pressure overshoot 1

Control mode VF FOC PG FOC PM Factory default: 0.2
 Settings 0.00~500.00 秒

00-42 Pressure overshoot level

Control mode VF FOC PG FOC PM Factory default: 2
 Settings 0~100%

By using the factory setting 250 bar of the Pr00-08 Maximum Pressure Feedback, when the pressure is over 5 bar ($250 \times 2\% = 5$ bar), another integral time of Pr00-39 will do overshoot protection.

When Pr00-38=1 and Pr00-39=0, Pr00-42 is disable.

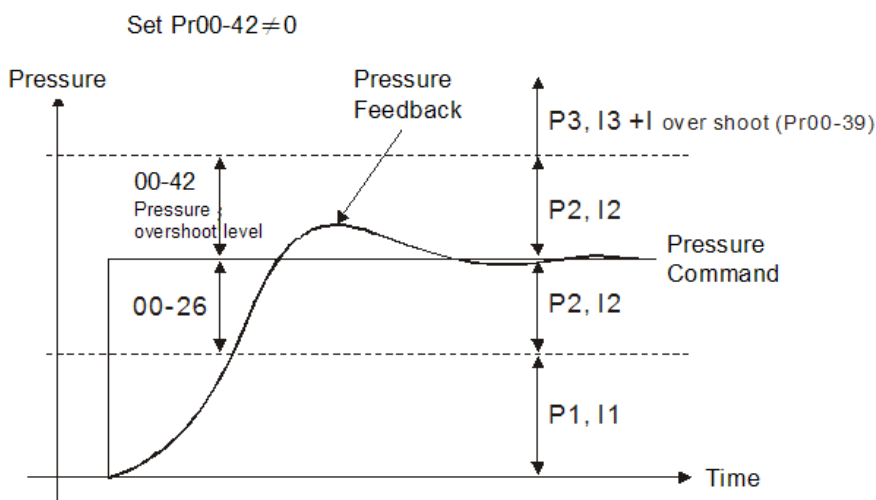
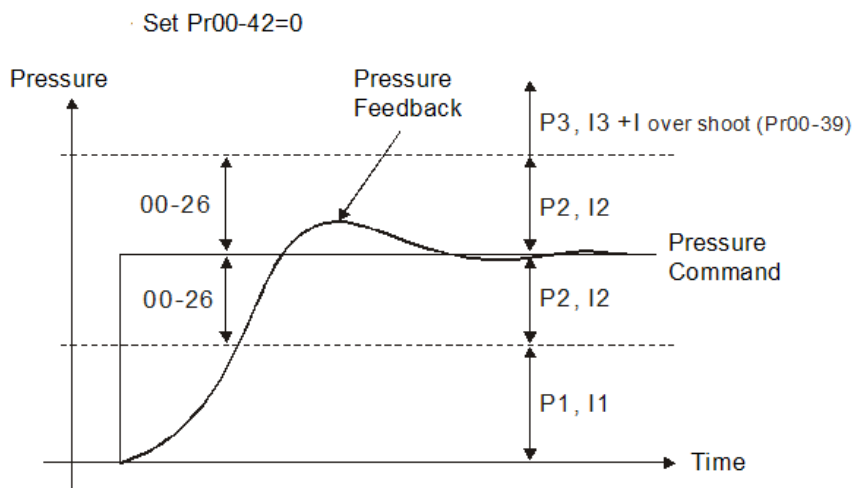

00-40 Reserved

00-41 Reserved

00-43 Maximum Flow

Control mode VF FOC PG FOC PM

Factory default: 100

Settings 0~100%

Set up this parameter to adjust the maximum rotation frequency (maximum flow rate). It is not necessary to stop the motor drive to set up this parameter. When this parameter is set to be 100%, it corresponds to the maximum rotation frequency of Pr01-02.

00-44 Pressure Command

Control mode VF FOC PG FOC PM

Factory default: 0

Settings 0~400bar

00-45 Flow Command

Control mode VF FOC PG FOC PM

Factory default: 0

Settings 0~100%

- When Pr00-44 ≠ 0, Pressure Command will not be given by the analog signal but input by Pr00-44.
- When Pr00-45 ≠ 0, Flow Command will not be given by the analog signal but input by Pr00-45.
- Pr00-44 & Pr00-45 can be applied in an environment without input of analog signal to do simple test.

00-46 Pressure reference S1 time

Control mode VF FOC PG FOC PM

Factory default: 0

Settings 0~1000ms

00-47 Pressure reference S2 time

Control mode VF FOC PG FOC PM

Factory default: 0

Settings 0~1000ms

To increase the smoothness at start or stop while increasing or decreasing the percentage of the pressure command. The longer the pressure reference time, the smoother it will be.

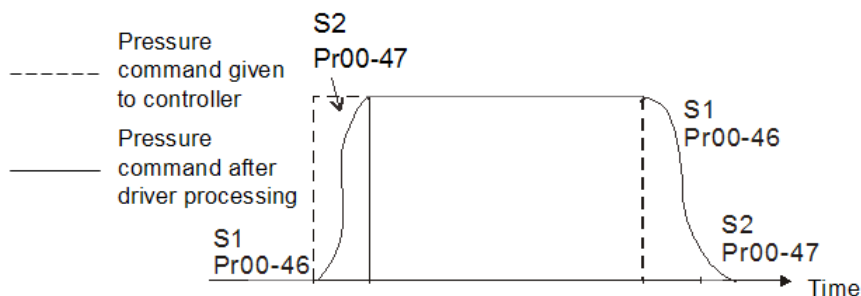

00-48 Flow reference S1 time

Control mode VF FOC PG FOC PM

Factory default: 0

Settings 0~1000ms

00-49 Flow reference S2 time

Control mode VF FOC PG FOC PM

Factory default: 0

Settings 0~1000ms

 To increase the smoothness at start or stop while increasing or decreasing the percentage of the flow command. The longer the flow reference time, the smoother it will be.

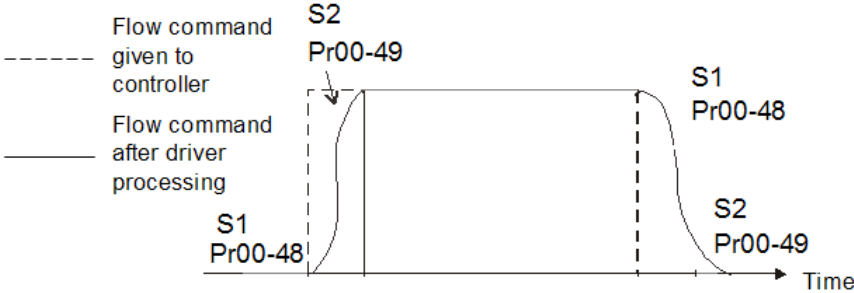

01 Motor Parameters

✎ the parameter can be set during operation

01-00 Control mode

Control mode	VF	FOCPG	FOCPM	Factory default: 5
Settings			0 : V/F 1: Reserved 2: Reserved 3: FOCPG 4: Reserved 5: FOCPM 6: Reserved	

📖 This parameter determines the control mode of this AC motor.

0: V/F control, the user can design the required V/F ratio. It is used for induction motors.

1: Reserved

2: Reserved

3: FOC vector control + Encoder. It is used for induction motors.

4: Reserved

5: FOC vector control + Encoder. It is used for synchronous motors.

In FOCPM (Pr.01-00=5), set display the speed defined by user (Pr.00-06), the motor maximum operation frequency(PR.01-02) will revise the number of poles of the synchronous motor (Pr.01-20).

$$f = \text{rpm} * \text{Pole} / 120$$

6: Reserved

✎ 01-01 Source of operation command

Control mode	VF	FOCPG	FOCPM	Factory default: 0
Settings			0: The operation command is controlled by the digital operation panel 1: The operation command is controlled by the external terminals. The STOP button on the keypad panel is disabled 2: The operation command is controlled by the communication interface. The STOP button on the keypad panel is disabled	

📖 For the operation command, press the PU button to allow the “PU” indicator to be lit. In this case, the RUN, JOG, and STOP button are enabled.

01-02 Motor’s maximum operation frequency

Control mode	VF	FOCPG	FOCPM	Factory default: 166.67
Settings			50.00 – 600.00Hz	

📖 Set the maximum operation frequency range of the motor. This setting is corresponding to the maximum flow for the system.

📖 In FOCPM (Pr.01-00=5), set display the speed defined by user (Pr.00-06), the motor maximum operation frequency(PR.01-02) will revise the number of poles of the synchronous motor (Pr.01-20).

📖 $f = \text{rpm} * \text{Pole} / 120$

01-03 Motor’s rated frequency

Control mode	VF	FOCPG	FOCPM	Factory default: 113.33
Settings			0.00~600.00Hz	

Typically, this setting is configured according to the rated voltage and frequency listed in the specifications on the motor's nameplate. If the motor is intended for 60Hz, set this value as 60Hz; if the motor is intended for 50Hz, set this value as 50Hz.

01-04 Motor's rated voltage

Control mode	VF	FOCPG	Factory default: 220.0/440.0
Settings	230V series: 0.1 – 255.0V 460V series: 0.1 – 510.0V		

Typically, this setting is configured according to the rated operation voltage shown on the motor's nameplate. If the motor is intended for 220V, set this value as 220.0V; if the motor is intended for 200V, set this value as 200.0V.

01-05 Acceleration time setting

Control mode	VF	FOCPG	FOCPM	Factory default: 0.00
Settings	0.00 – 600.00 seconds			

01-06 Deceleration time setting

Control mode	VF	FOCPG	FOCPM	Factory default: 0.00
Settings	0.00 – 600.00 seconds			

The acceleration time determines the time required for the Hybrid servo motor to accelerate from 0.0Hz to [the motor's maximum frequency] (01-02). The deceleration time determines the time required for the Hybrid servo motor to decelerate from [the motor's maximum frequency] (01-02) to 0.0Hz.

01-07 Motor Parameter Auto Tuning

Settings	Factory default: 0			
	Control mode	VF	FOCPG	FOCPM
0: No function		<input type="radio"/>	<input type="radio"/>	
1: Rolling test for induction motor(IM) (Rs, Rr, Lm, Lx, no-load current)		<input type="radio"/>	<input type="radio"/>	
2: Static test for induction motor(IM)		<input type="radio"/>	<input type="radio"/>	
3: Reserved				
4: Auto measure the angle between magnetic pole and PG origin				<input type="radio"/>
5: Rolling test for PM motor				<input type="radio"/>

If the parameter is set as 1~2, it will perform the parameter automatic tuning for the Induction motor. In this case, press the [Run] button to perform the automatic measurement operation immediately. After the measurement is complete, the values are filled into Parameters 01-13~16 (no-load current, Rs, Rr, Lm, and Lx), respectively.

Induction motor *AUTO-Tuning procedure*:(Rolling test)

- All parameters of the Hybrid servo drive are set to factory settings and the motor is connected correctly.
- Users are strongly advised to disconnect the motor from any load before tuning. That is to say, the motor contains only the output shaft and connects to neither a belt nor a decelerator. Otherwise, it will be impossible to disconnect the motor from any loads. Static tuning is

advised※.

3. Set the rated voltage 01-04, rated frequency 01-03, rated current 01-08, rated power 01-09, rated speed 01-10, and number of poles 01-11 of the motor with correct values, respectively. For the acceleration/deceleration time, please set the correct values.
4. Set Parameter 01-07 as 1 and then press the RUN button on the keypad. The auto tuning process for the motor is carried out immediately. (Note: the motor starts running).
5. After the process is finished, check if the motor's parameters (parameters 01-13 ~ 16) have been automatically entered with the measurement data.
6. Equivalent circuit of the motor

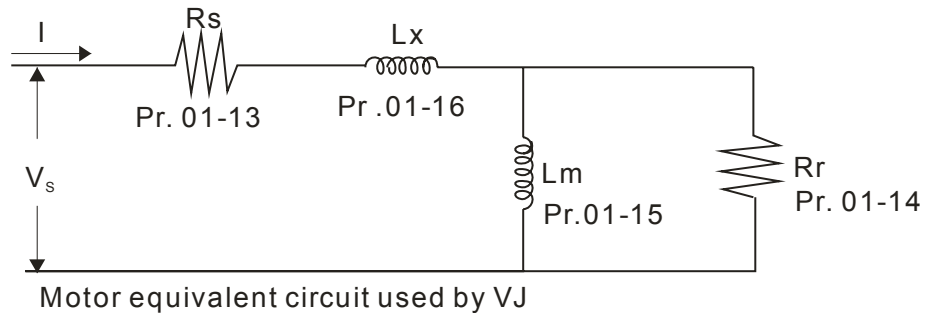

NOTE

* When the static tuning (parameters 01-07 = 2) is used, you must enter the no-load current of the motor. It is generally 20 to 50% of the rated current.

📖 If the parameter is set as 5, it will perform the parameter automatic tuning for the synchronous motor. In this case, press the [Run] button to perform the automatic measurement operation immediately. After the measurement is complete, the values are filled into Parameters 01-22 (Rs), 01-23 & 24 (Ld & Lq), 01-25 (Back EMF of the synchronous motor), respectively.

Synchronous motor AUTO-Tuning procedure:(static measurement)

1. All parameters of the Hybrid servo drive are set to factory settings and the motor is connected correctly.
2. Set the rated current 01-17, rated power 01-18, rated speed 01-19, and number of poles 01-20 of the motor with correct values, respectively. For the acceleration/deceleration time, please set the values according to the motor's capacity.
3. Set Parameter 01-07 as 5 and then press the RUN button. The auto tuning process for the motor is carried out immediately. (Note: the motor starts running slightly).
4. After the process is finished, check if the motor's parameters (parameters 01-22 ~ 01-25) have been automatically entered with the measurement data.

📖 If the Parameter is set as 4, the automatic measurement of the angle between magnetic pole and the PG origin for the synchronous motor is performed. In this case, press the [Run] button to immediately perform automatic measurement. The measured data will be entered into Parameter 01-27.

Angle between magnetic pole and the PG origin Auto-Tuning process for the synchronous motor:

1. After the measurement process for parameter value of 5 is performed completely or manually enter the Parameters 01-03, 01-17 and 01-25, respectively.

2. Before tuning, it is recommended to separate the motor and the load.
3. Set Parameter 01-07 as 4 and then press the RUN button on the keypad. The auto tuning process for the motor is carried out immediately. (Note: the motor starts running).
4. After the process is complete, please check if the values for the angle between magnetic poles and PG origin have been automatically entered in the Parameter 01-27.

01-08 Rated current of the induction motor (A)

Control mode	FOCPG	Unit: Ampere
		Factory default: ###
Settings	40~120% of the rated driving current	

 To set this parameter, the user can set the rated motor current range shown on the motor's nameplate. The factory default is 90% of the rated current of the Hybrid servo drive.

For example: For the 7.5HP (5.5kW) motor, the rated current is 25, the factory settings: 22.5A.

The customers can set the parameter within the range 10 ~ 30A.

$$25 \times 40\% = 10 \quad 25 \times 120\% = 30$$

01-09 Rated power of the induction motor

Control mode	FOCPG	Factory default: ###
Settings	0 – 655.35kW	

 Set the motor's rated power. The factory default value is the power of the Hybrid servo drive.

01-10 Rated speed of the induction motor

Control mode	FOCPG	Factory default: 1710 (60Hz 4-pole) 1410 (50Hz 4-pole)
Settings	0~65535	

 This parameter sets the rated speed of the motor. It is necessary to refer to the specifications shown on the motor's nameplate.

01-11 Number of poles of the induction motor

Control mode	FOCPG	Factory default: 4
Settings	2~20	

 This parameter sets the number of motor number of poles (odd number is not allowed).

01-12 No-load current of the induction motor (A)

Control mode	FOCPG	Unit: Ampere
		Factory default: 40
Settings	0~ Default value of Parameter 01-08	

 The factory default is 40% of the rated current of the Hybrid servo drive.

01-13 Stator resistance (Rs) of the induction motor

Control mode FOCPG Factory default: ###

01-14 Rotor resistance (Rr) of the induction motor

Control mode FOCPG Factory default: ###

Settings 0~65.535Ω

01-15 Magnetizing inductance (Lm) of the induction motor

Control mode FOCPG Factory default: ###

01-16 Total leakage inductance (Lx) of the induction motor

Control mode FOCPG Factory default: ###

Settings 0.0~6553.5mH

01-17 Rated current of the synchronous motor

Control mode FOCPM Factory default: 0.00

Settings 0~655.35 Amps

 The user can set the rated current shown on the synchronous motor's nameplate.

01-18 Rated power of the synchronous motor

Control mode FOCPM Factory default: 0.00

Settings 0.00 – 655.35kW

 This Parameter sets the rated power of the synchronous motor.

01-19 Rated speed of the synchronous motor

Control mode FOCPM Factory default: 1700

Settings 0~65535

 This parameter sets the rated speed of the synchronous motor. It is necessary to refer to the specifications shown on the motor's nameplate.

01-20 Number of poles of the synchronous motor

Control mode FOCPM Factory default: 8

Settings 2~20

 This parameter sets the number of the synchronous motor's number of poles (odd number is not allowed).

01-21 Inertia of the synchronous motor's rotor

Control mode FOCPM Factory default: 0.0

Settings 0.0~6553.5 *10⁻⁴ kg.m²

01-22 Stator's phase resistance (Rs) oth the synchronous motor

Control mode FOCPM Factory default: 0.000

Settings 0~65.535Ω

 Enter the phase resistance of the synchronous motor.

01-23 stator's phase inductance(Ld) of the synchronous motor

01-24 stator's phase inductance(Lq) of the synchronous motor

Control mode **FOCPM** Factory default: 0.00
 Settings 0.0~655.35mH

 Enter the synchronous motor's phase inductance. For surface type magnets (SPM), $L_d = L_q$; for built-in magnets (IPM), $L_d \neq L_q$.

01-25 Back EMF of the synchronous motor

Control mode **FOCPM** Factory default: 0
 Settings 0~65535 V/krpm

 Enter the back EMF of the synchronous motor.

01-26 Encoder type selection

Control mode **FOCPM** Factory default: 3
 Settings 0: ABZ
 1: ABZ+HALL (only used for Delta's servo motors)
 2: ABZ+HALL
 3: Resolver

 Look up table for Encoders & PG cards

Parameter Setting	Encoder Type	Applicable PG Card
01-26=0	A, B, Z	EMVJ-PG01U
01-26=1,2	A, B, Z+U, V, W	EMVJ-PG01U
01-26=3	Resolver	EMVJ-PG01/02R

01-27 PG Offset angle of synchronous motor

Control mode **FOCPM** Factory default: 0.0
 Settings 0.0~360.0°

 Offset angle of the PG origin for the synchronous motor.

01-28 Number of poles of the resolver

Control mode **FOCPM** Factory default: 1
 Settings 1~5

01-29 Encoder Pulse

Control mode **FOCPG FOCPM** Factory default: 1024
 Settings 1~20000

 This parameter can be set the encoder's number of pulses per revolution (PPR).

01-30 Encoder's input type setting

Control mode **FOCPG FOCPM** Factory default: 1
 Settings 0: No function

1: Phase A leads in a forward run command and phase B leads in a reverse run command.

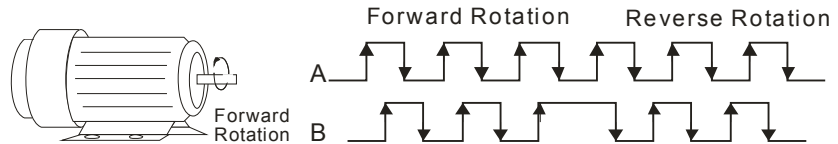

2: Phase B leads in a forward run command and phase A leads in a reverse run command.

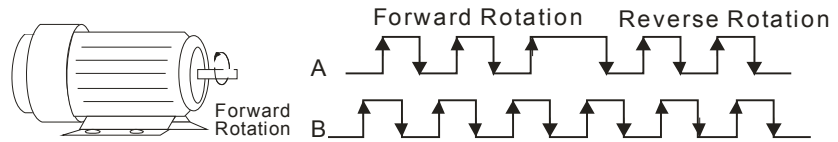

3: Phase A is a pulse input and phase B is a direction input. (low input=reverse direction, high input=forward direction).

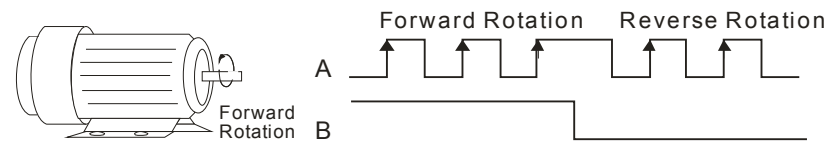

4: Phase A is a pulse input and phase B is a direction input. (low input=forward direction, high input=reverse direction).

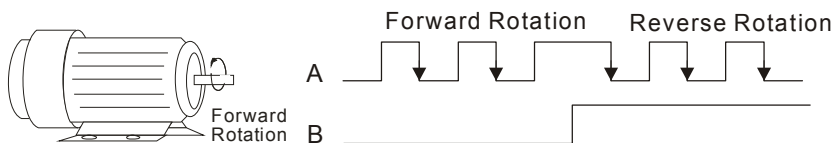

5: Single-phase input

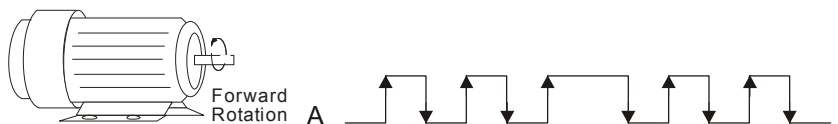

📖 Enter the correct setting for the pulse type is helpful in controlling the stability.

01-31 System control

Control mode	FOCPG	FOCPM	Factory default: 1
Settings	0: No function 1: ASR automatic tuning 2: Estimation of inertia		

📖 If the setting value is 1: The speed control gain is determined by Parameters 00-10
If the setting value is 2: The system inertia is estimated. Please refer to descriptions in Chapter 3

01-32 Unity value of the system inertia

Control mode	FOCPG	FOCPM	Factory default: 400
Settings	1~65535 (256 = 1 per unit)		

01-33 Carrier frequency

Control mode	FOCPG	FOCPM	Factory default: 5
Settings	5 kHz; 10kHz		

📖 When this parameter is configured, please re-start the Hybrid servo drive.
📖 The carrier frequency of the PWM output has a significant influence on the electromagnetic noise

of the motor. The heat dissipation of the Hybrid servo drive and the interference from the environment may also affect the noise. Therefore, if the ambient noise is greater than the motor noise, reducing the carrier frequency of the drive may have the benefits of reducing a temperature rise; if the carrier frequency is high, even if a quiet operation is obtained, the overall wiring and interference control should be taken into consideration.

01-34 Reserved

01-35 Motor ID

Control mode	FOCPG	FOCPM	Factory default: 0
Settings		0 : No function	
		16: Delta's Hybrid servo motor ECMA-ER181BP3 (11kW220V)	
		17: Delta's Hybrid servo motor ECMA- KR181BP3 (11kW380V)	
		18: Delta's Hybrid servo motor ECMA-ER221FPS (15kW220V)	
		19: Delta's Hybrid servo motor ECMA-KR221FPS (15kW380V)	
		20: Delta's Hybrid servo motor ECMA-ER222APS (20kW220V)	
		21: Delta's Hybrid servo motor ECMA-KR222APS (20kW380V)	
		114: Hybrid servo motor MSJ-ER0975E28B (7.5kW220V)	
		115: Hybrid servo motor MSJ-KR0975E28B (7.5kW380V)	
		125: Hybrid servo motor MSJ-KR133AE48B (30kW380V)	

01-36 Change the rotation direction

Control mode	FOCPG	FOCPM	Factory default: 0
Settings		0: When the driver runs forward, the motor rotates counterclockwise. When the driver runs reverse, the motor rotates clockwise.	
		1: When the driver runs forward, the motor rotates clockwise. When the driver runs reverse, the motor rotates counterclockwise.	

 This parameter can be modified only when the machine is shut down. For induction motor after the parameters are configured completely, it will change the running direction. For synchronous motor, it is necessary to perform the magnetic pole detection and re-start the drive.

 For synchronous motor, in version 2.04 (included), it is necessary to perform the magnetic pole detection and re-start the drive. In version 2.05, it doesn't.

01-37 HES ID#

Control mode	FOCPG	FOCPM	Factory default: 0
Settings		0 : No function	

Example: HES100G23A

Model	ID#	Model	ID#
HES050H23C	1122	HES050H43C	1142
HES063H23A	2120	HES063G43A	2040
HES080G23A	3020	HES063H43A	2140
HES080H23A	3120	HES080G43A	3040
HES100G23A	4020	HES080H43A	3140
HES100H23A	4120	HES100G43A	4040

HES100Z23A	4220
HES125G23A	5020
HES125H23A	5120
HES160G23A	6020
HES160H23A	6120
HES200G23A	7020

HES100H43A	4140
HES100Z43A	4240
HES125G43A	5040
HES125H43A	5140
HES160G43A	6040
HES160H43A	6140
HES200G43A	7040
HES200H43C	7142
HES250H43C	8142

0-2 Parameters for Protection

↗ the parameter can be set during operation

↗ 02-00 Software brake level

Control mode	VF	FOCPG	FOCPM	Factory default: 380.0/760.0
Settings	230V series: 350.0~450.0Vdc 460V series: 700.0~900.0Vdc			

📖 Sets the reference point of software brake. The reference value is the DC bus voltage.

02-01 Present fault record

02-02 Second most recent fault record

02-03 Third most recent fault record

02-04 Fourth most recent fault record

02-05 Fifth most recent fault record

02-06 Sixth most recent fault record

Settings	Control mode	VF	FOCPG	FOCPM
0: No error record		<input type="radio"/>	<input type="radio"/>	<input type="radio"/>
1: Over-current during acceleration (ocA)		<input type="radio"/>	<input type="radio"/>	<input type="radio"/>
2: Over-current during deceleration (ocd)		<input type="radio"/>	<input type="radio"/>	<input type="radio"/>
3: Over-current during constant speed (ocn)		<input type="radio"/>	<input type="radio"/>	<input type="radio"/>
4: Ground fault (GFF)		<input type="radio"/>	<input type="radio"/>	<input type="radio"/>
5: IGBT short-circuit (occ)		<input type="radio"/>	<input type="radio"/>	<input type="radio"/>
6: Over-current at stop (ocS)		<input type="radio"/>	<input type="radio"/>	<input type="radio"/>
7: Over-voltage during acceleration (ovA)		<input type="radio"/>	<input type="radio"/>	<input type="radio"/>
8: Over-voltage during deceleration (ovd)		<input type="radio"/>	<input type="radio"/>	<input type="radio"/>
9: Over-voltage during constant speed (ovn)		<input type="radio"/>	<input type="radio"/>	<input type="radio"/>
10: Over-voltage at stop (ovS)		<input type="radio"/>	<input type="radio"/>	<input type="radio"/>
11: Low-voltage during acceleration (LvA)		<input type="radio"/>	<input type="radio"/>	<input type="radio"/>
12: Low-voltage during deceleration (Lvd)		<input type="radio"/>	<input type="radio"/>	<input type="radio"/>
13: Low-voltage during constant speed (Lvn)		<input type="radio"/>	<input type="radio"/>	<input type="radio"/>
14: Low-voltage at stop (LvS)		<input type="radio"/>	<input type="radio"/>	<input type="radio"/>
15: Phase loss protection (PHL)		<input type="radio"/>	<input type="radio"/>	<input type="radio"/>
16: IGBT over-heat (oH1)		<input type="radio"/>	<input type="radio"/>	<input type="radio"/>
17: Heat sink over-heat for 40HP and above (oH2)		<input type="radio"/>	<input type="radio"/>	<input type="radio"/>
18: TH1 open: IGBT over-heat protection circuit error (tH1o)		<input type="radio"/>	<input type="radio"/>	<input type="radio"/>
19: TH2 open: heat sink over-heat protection circuit error (tH2o)		<input type="radio"/>	<input type="radio"/>	<input type="radio"/>
20: IGBT over heated and unusual fan function (oHF)		<input type="radio"/>	<input type="radio"/>	<input type="radio"/>
21: Hybrid servo drive overload (oL)		<input type="radio"/>	<input type="radio"/>	<input type="radio"/>
22: Motor 1 overload (EoL1)		<input type="radio"/>	<input type="radio"/>	<input type="radio"/>
23: Reserved				
24: Motor over-heat, detect by PTC (oH3)		<input type="radio"/>	<input type="radio"/>	<input type="radio"/>
25: Reserved				

26: Over-torque 1 (ot1)	○	○	○
27: Over-torque 2 (ot2)	○	○	○
28: Reserved			
29: Reserved			
30: Memory write error (cF1)	○	○	○
31: Memory read error (cF2)	○	○	○
32: Isum current detection error (cd0)	○	○	○
33: U-phase current detection error (cd1)	○	○	○
34: V-phase current detection error (cd2)	○	○	○
35: W-phase current detection error (cd3)	○	○	○
36: Clamp current detection error (Hd0)	○	○	○
37: Over-current detection error (Hd1)	○	○	○
38: Over-voltage current detection error (Hd2)	○	○	○
39: Ground current detection error (Hd3)	○	○	○
40: Auto tuning error (AuE)			○
41: Reserved	○	○	○
42: PG feedback error (PGF1)		○	○
43: PG feedback loss (PGF2)		○	○
44: PG feedback stall (PGF3)		○	○
45: PG feedback slip (PGF4)		○	○
46: Reserved	○	○	○
47: Reserved	○	○	○
48: Reserved			
49: External fault input (EF)	○	○	○
50: Emergency stop (EF1)	○	○	○
51: Reserved			
52: Password error (PcodE)	○	○	○
53: Reserved			
54: Communication error (cE1)	○	○	○
55: Communication error (cE2)	○	○	○
56: Communication error (cE3)	○	○	○
57: Communication error (cE4)	○	○	○
58: Communication time out (cE10)	○	○	○
59: PU time out (cP10)	○	○	○
60: Braking transistor error (bF)	○	○	○
61~63: Reserved	○	○	○
64: Safety relay Error (SRY)	○	○	○
65: PG card information error (PGF5)			○
66: Over pressure (ovP)	○	○	○
67: Pressure feedback fault (PfbF)	○	○	○

 As a fault occurs and the machine is forced shutting down, the event will be recorded. During shutting down, the LvS is not recorded.

02-07 Low voltage level

Control mode VF FOC PG FOC PM

Factory default: 180/360

Settings 230V Series: 160 – 220V
460V Series: 320 – 440V

 This parameter is used to set the LV discrimination level.

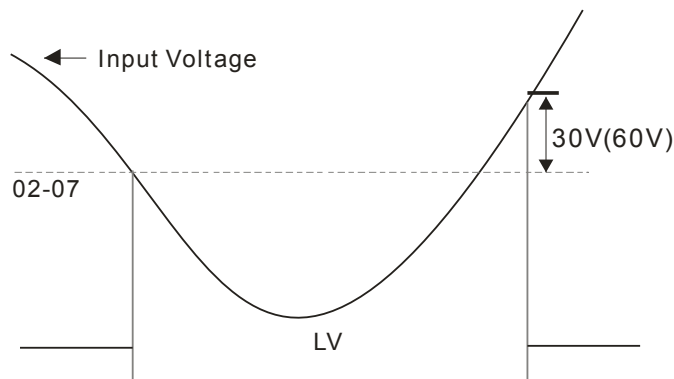

02-08 PTC action selection

Control mode VF FOC PG FOC PM

Factory default: 1

Settings 0: Warn and keep operation
1: Warn and ramp to stop
2: Warn and coast to stop

 Parameter 02-08 is used to define the operation mode of the drive after the PTC is activated.

02-09 PTC level

Control mode VF FOC PG FOC PM

Factory default: 50.0

Settings 0.0~150.0%
0.0~150.0°C

 This parameter defines the maximum value of the analog input for 100% of the activation level of the PTC.

02-10 PTC detection filtering time

Control mode VF FOC PG FOC PM

Factory default: 0.20

Settings 0.00 – 10.00 seconds

02-11 PTC type

Control mode VF FOC PG FOC PM

Factory default: 0

Settings 0: Not assigned
1: KTY84

 When this parameter is set as 1, the unit for Parameters 02-09 and 02-12 will be changed from % to °C.

 When this parameter is set as 1, the default setting of Pr.02-09 will change from 50% to 125°C.

02-12 Motor fan activation level

Control mode VF FOC PG FOC PM

Factory default: 50.0

Settings 0.0~100.0%

0.0~150.0°C

📖 When the Parameters 03-05 to 03-07 for the multi-function output terminal are set to 45, the motor fan will start or stop according to this parameter setting.

↗ **02-13** Electronic thermal relay selection 1

Control mode	VF	FOCPG	FOCPM	Factory default: 2
Settings	0: Inverter motor 1: Standard motor 2: Disable			

↗ **02-14** Electronic thermal characteristic for motor

Control mode	VF	FOCPG	FOCPM	Factory default: 60.0
Settings	30.0 – 600.0 seconds			

📖 To prevent self-cooled motor from over heating at low speed operation, the user can set the electronic thermal relay to limit the allowed output power of the Hybrid servo drive.

02-15 Output frequency at malfunction

Control mode	VF	FOCPG	FOCPM	Factory default: Read only
Settings	0.00 – 655.35Hz			

02-16 Output voltage at malfunction

Control mode	VF	FOCPG	FOCPM	Factory default: Read only
Settings	0.0 – 6553.5V			

02-17 DC side voltage at malfunction

Control mode	VF	FOCPG	FOCPM	Factory default: Read only
Settings	0.0 – 6553.5V			

02-18 Output current at malfunction

Control mode	VF	FOCPG	FOCPM	Factory default: Read only
Settings	0.00~655.35Amp			

02-19 IGBT temperature at malfunction

Control mode	VF	FOCPG	FOCPM	Factory default: Read only
Settings	0.0~6553.5°C			

03 Digital/Analog Input/Output Parameters

↗ the parameter can be set during operation

03-00 Multi-function input command 3 (MI3)

03-01 Multi-function input command 4 (MI4)

03-02 Multi-function input command 5 (MI5)

Control mode VF FOCPG FOCPM Factory default: 0

Settings 0: No function
 44: Injection signal input
 45: Confluence/Diversion signal input
 46: Reserved
 47: Multi-level pressure PI command 1
 48: Multi-level pressure PI command 2

📖 When the value of this parameter is set as 44, the pressure feedback is lower than the pressure stable region (please refer to the description of Parameter 00-26) so the flow control will be performed. When it enters the pressure stable region, the pressure control will be performed.

📖 If the setting value is 45, the confluence (OFF)/diversion (ON) function will be performed. For detailed operation, please refer to Chapter 2 for wiring and Chapter 3 for tuning.

📖 Please refer to the description Parameters 00-36 if the setting value is 47 and 48,

↗ **03-03** Digital input response time

Control mode VF FOCPG FOCPM Factory default: 0.005

Settings 0.001~30.000 sec

📖 This parameter is used to delay and confirm the signal on the digital input terminal.

↗ **03-04** Digital input operation direction

Control mode VF FOCPG FOCPM Factory default: 0

Settings 0~65535

📖 This parameter defines the activation level of the input signal.

📖 Bit 0 for the SON terminal, bit 2 for the EMG terminal, bit 3 for the RES terminal, bits 4~6 correspond to MI3~MI5, respectively.

↗ **03-05** Multi-function output 1 (Relay 1)

Control mode VF FOCPG FOCPM Factory default: 11

↗ **03-06** Multi-function Output 2 (MOI)

Control mode VF FOCPG FOCPM Factory default: 0

↗ **03-07** Multi-function Output 3 (MO2)

Control mode VF FOCPG FOCPM Factory default: 0

Settings 0: No function
 1: Operation indication
 9: Hybrid servo drive is ready
 11: Error indication
 44: Displacement switch signal
 45: Motor fan control signal

03-08 Multi-function output direction

Control mode VF FOC PG FOC PM

Factory default: 0

Settings 0~65535

This parameter is used for bit-wise setting. If the corresponding bit is 1, the multi-function output is set as reverse direction.

03-09 Low-pass filtering time of keypad display

Control mode VF FOC PG FOC PM

Factory default: 0.010

Settings 0.001~65.535 seconds

This parameter can be set to reduce the fluctuation of the readings on the keypad.

03-10 Maximum output voltage for pressure feedback

Control mode VF FOC PG FOC PM

Factory default: 10.0

Settings 5.0~10.0 V

03-11 Minimum output voltage for pressure feedback

Control mode VF FOC PG FOC PM

Factory default: 0.0

Settings 0.0~2.0V

This parameter defines the pressure feedback output voltage type.

If the pressure feedback has a bias, can adjust this parameter to eliminate the bias.

03-12 Current/Voltage type pressure sensor selection

Control mode VF FOC PG FOC PM

Factory default: 1

Settings 0: Current type (4mA~20mA)

1: Voltage type

PO (Pressure Feedback) terminal: Add a current-fed pressure feedback (4~20mA)

The following are required when using it:

Switch the SW100 on the I/O board to "1".



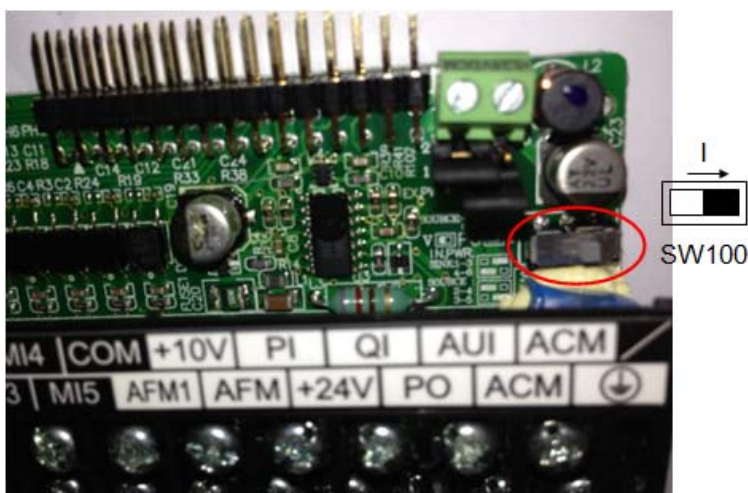

Set Pr03-12 = 0 (4~20mA)

Set Pr00-36 = 1 (Enable detection of the pressure feedback disconnection)





03-13 Confluence Master/Slave Selection

Control mode	VF	FOCPG	FOCPM	Factory default: 0
Settings	0: No function 1: Master 1 2: Slave/Master 2 3: Slave/Master 3			

-  In a stand-alone system, this parameter is set as 0
-  In a confluence system, the parameter is set as 1 for the Master and 2 for the Slave
-  With multi-function input terminal function 45, the confluence/diversion can be configured. For detailed operation, please refer to Chapter 2 for wiring and Chapter 3 for tuning.
-  The difference between Master 2 and Master 3 is that the Master 3 can be configured as confluent with other Slaves during confluence, however, the Master 2 can be configured for stand-alone operation.



03-14 Slave's proportion of the Master's flow

Control mode	VF	FOCPG	FOCPM	Factory default: 100.0
Settings	0.0~65535.5 %			

-  This parameter setting is required only for the Master but not needed for the Slave.
-  In a confluence system, this parameter value defines the Slave's portion of the Master's flow.
Example: Slave is 60L/min and Master is 40L/min, so the setting is $60/40 * 100\% = 150\%$
For confluence of more than 2 pump, the values for the slaves must be the same. For example, if the total flow for a three-pump system is 200L/min, where the Master is 40L/min, then the two Slaves should be 80L/min. The setting of Parameter 03-14 should be $160/40 = 400\%$

03-15 Source of frequency command

Control mode	VF	FOCPG	FOCPM	Factory default: 0
Settings	0: Digital Operation Panel 1: RS485 Communication 2~5: Reserved			

-  This parameter is used for EMVJ-MF01. For detailed operation, please refer to Chapter 3 for tuning.
-  In a confluence system, if the Slave's frequency command is given through the RS485 communication, the setting value should be 1.

03-16 Limit for the Slave reverse depressurization torque

Control mode	VF	FOCPG	FOCPM	Factory default: 20
Settings	0~500%			

-  Set the torque limit for the Slave's reverse operation.

03-17 Slave's activation level

Control mode	VF	FOCPG	FOCPM	Factory default: 50
Settings	0~100%			

- 📖 This parameter setting is required only for the Master but not needed for the Slave.
- 📖 This parameter determines the activation level for the Slave. A 100% value corresponds to the full flow of the Master.

✦ **03-18** Communication error treatment

Control mode	VF	FOCPG	FOCPM	Factory default: 0
Settings	0: Warn and keep operation 1: Warn and ramp to stop 2: Warn and coast to stop 3: No action and no display			

- 📖 This parameter is used to set the handling status of the drive when a communication timeout error (such as disconnection) occurs.

✦ **03-19** Time-out detection

Control mode	VF	FOCPG	FOCPM	Factory default: 0.0
Settings	0.0~100.0 seconds			

- 📖 This parameter is used to set the time of the time-out event for the communication and the keypad transmission.

✦ **03-20** Start-up display selection

Control mode	VF	FOCPG	FOCPM	Factory default: 0
Settings	0: F (frequency command) 1: H (actual frequency) 2: Multi-function display (user-defined 00-04) 3: A (Output current)			

- 📖 This parameter is used to set the contents of the start-up screen. The content of the user-defined option is displayed in accordance with the setting value of Parameter 00-04.

✦ **03-21** Slave reverse operation for depressurization

Control mode	VF	FOCPG	FOCPM	Factory default: 0
Settings	0: Disabled 1: Enabled			

- 📖 This parameter setting is required only for the Slave but not needed for the Master.
- 📖 When the parameter is set as 1, it is necessary to make sure that the outlet end of the Slave is not installed with any one-way valve and the parameter 03-16 is set as 500.

5. Fault Codes and Descriptions

- 5-1 Error Messages
- 5-2 Over Current OC
- 5-3 Ground Fault GFF
- 5-4 Over Voltage OV
- 5-5 Low Voltage Lv
- 5-6 Over Heat OH1
- 5-7 Overload OL
- 5-8 Phase Loss PHL
- 5-9 Electromagnetic/Induction Noise
- 5-10 Environmental Condition

The Hybrid servo drive has warning messages and protection functions such as over-voltage, low-voltage, over-current, etc. Once a fault occurs, the protection function is activated, the Hybrid servo drive stops output, and the motor coast to stop. Please look up the cause for the fault and perform the countermeasure according to the error message of the Hybrid servo drive. The error records are stored in the internal memory of the Hybrid servo drive (last six error messages can be recorded) and can be read out through the keypad or through the communication port.



- ☑ After a fault occurs, the RESET button will be effective only 5 seconds after the fault condition is released.
- ☑ For Hybrid servo drives of power rating $\leq 22\text{kW}$, it is necessary to wait for 5 minutes (10 minutes for $\geq 30\text{kW}$) after the power is shut down to confirm that the indicator light is off and the measured DC voltage across the terminals \oplus and \ominus is below DC 25V before opening the cover for inspection.

5-1 Error Messages



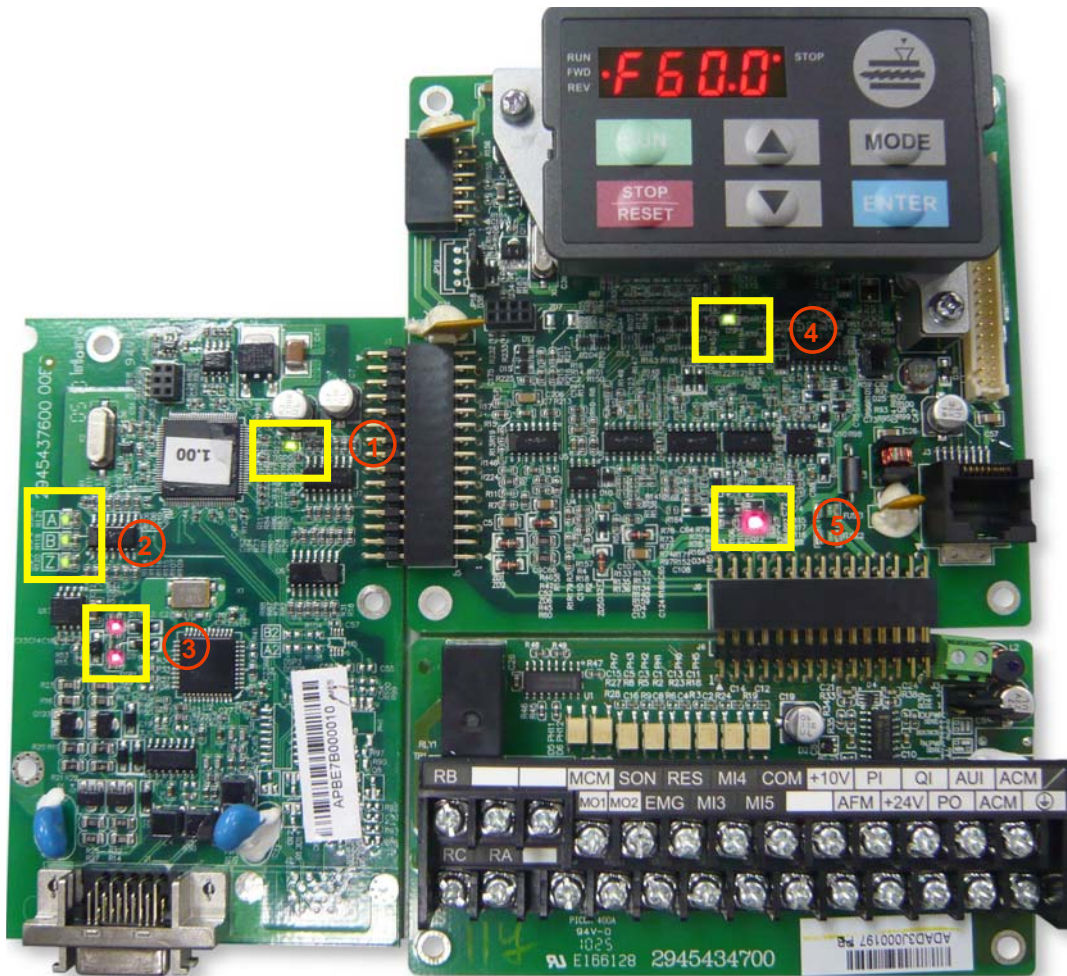







5-1-1 Light indication





























- ① Indicator of PG card power
- ② Indicator of Encoder feedback
- ③ Warning indicator
- ④ Power indicator
- ⑤ Power indicator







When the sin or cos phase voltage is lower than required values in the rotational transformer, the warning indicator will be on. Please check if the encoder wire is connected correctly. If it happens in operation, please check for any interference.

5-1-2 Error Messages Displayed on KPVJ-LE01 Digital Keypad Panel

Displayed Code	Description of Failure	Solutions
	Over current during acceleration; the output current exceeds three times the rated current of the Hybrid servo drive.	Check the connection from U-V-W to the motor for any improper insulation. Check if the motor is jammed. Replace with an AC motor drive with a larger output capacity.
	Over current during deceleration; the output current exceeds three times the rated current of the Hybrid servo drive.	
	Over current during constant speed operation; the output current exceeds three times the rated current of the Hybrid servo drive.	
	Over-current when the machine stops. Malfunction of the current detection circuit	Return to factory for repair.
	The Hybrid servo drive detects short circuit between the IGBT module's upper and lower bridges.	Return to factory for repair.
	During acceleration, the Hybrid servo drive detects over-voltage at the internal DC side.	230V: DC 450V 460V: DC 900V Check if the input voltage is within the Hybrid servo drive's rated voltage range; and monitor if there is any voltage surge.
	During deceleration, the Hybrid servo drive detects over-voltage at the internal DC side.	For Hybrid servo drives below 22kW, the Parameter 02-00 can be adjusted for the activation level of the braking transistor
	During the constant speed operation, the Hybrid servo drive detects over-voltage at the internal DC side.	For Hybrid servo drives above 22kW, adjust the brake activation level of the braking unit (For detailed description, please refer to the operation manual of the braking unit)
	Over-voltage when the machine stops. Malfunction of the voltage detection circuit	Check if the input voltage is within the Hybrid servo drive's rated voltage range; and monitor if there is any voltage surge.
	During acceleration, the Hybrid servo drive's DC side voltage is lower than the setting value of Parameter 02-07.	Check if the voltage of the input power supply is normal. Check if there is any sudden heavy load. Adjust Parameter 02-07 for the low-voltage level

Displayed Code	Description of Failure	Solutions
	During deceleration, the Hybrid servo drive's DC side voltage is lower than the setting value of Parameter 02-07.	
	During constant speed operation, the Hybrid servo drive's DC side voltage is lower than the setting value of Parameter 02-07.	
	When the machine stops, the Hybrid servo drive's DC side voltage is lower than the setting value of Parameter 02-07.	
	Phase loss protection	Check if the single-phase input is used for the three-phase model or there is any phase loss. Check if it is a model with capacity higher than 40HP. If so, please check the AC-side fuse for burning.
	Ground protection is activated. When the Hybrid servo drive detects the output end is grounded and the grounding current is larger than 50% of the Hybrid servo drive's rated current. Note: Such a protection is used for protecting the Hybrid servo drive not for human body.	Check the connection to the motor for short circuit or ground fault. Make sure if the IGBT power module is damaged. Check the connection at the output side is improperly insulated.
	The Hybrid servo drive detects overheat of the IGBT with a temperature higher than the protection level 7.5 – 15HP: 90°C 20 – 100HP: 100°C	Check if the ambient temperature is too high. Check if the heat sink for any external object. Check if the fan is running. Check if the Hybrid servo drive has sufficient space.
	The Hybrid servo drive detects overheat of the heat sink with a temperature higher than the protection level (90°C)	Check if the ambient temperature is too high. Check if the heat sink for any external object. Check if the fan is running. Check if the Hybrid servo drive has sufficient space.
	The Hybrid servo drive detects the motor internal overheat which is higher than the protection level (02-09 PTC level)	Check if the motor is jammed. Check if the ambient temperature is too high. Increase the capacity of the motor
	IGBT over heated and unusual fan function	Check the fan kit to see if it is blocked. Return to factory for repair.

Displayed Code	Description of Failure	Solutions
	The output current is higher than the withstand current of the Hybrid servo drive.	Check if the motor for overload. Increase the output capacity of the Hybrid servo drive.
	Motor overload	Change the product condition
	DC side fuse (FUSE) burns for models of 30HP and below.	Check if the fuse of the transistor module is burning. Check the load side for any short circuit
	Memory write error.	Press the RESET button to reset the parameters to factory default settings.
	Memory read error.	If this method does not work, return to factory for repair.
	Error of the sum of the three-phase output current is detected	After restart the power supply, if the error still exists, return to factory for repair.
	Error U-phase current is detected.	
	Error V-phase current is detected.	
	Error W-phase current is detected.	
	When the external EF terminals close, the Hybrid servo drive stops output.	After clearing the cause of the error, press the "RESET" button.
	When the external EMG terminals close, the Hybrid servo drive stops output.	After clearing the cause of the error, press the "RESET" button.
	The Hybrid servo drive detects errors from the braking transistor.	After press the RESET button, if the message bF still exists, please return to factory for repair.
	OH1 hardware circuit error	Return to factory for repair.
	OH2 hardware circuit error	Return to factory for repair.
	cc protection hardware circuit error	After restart the power supply, if the error still exists, return to factory for repair.
	oc protection hardware circuit error	
	ov protection hardware circuit error	
	GFF protection hardware circuit error	

Displayed Code	Description of Failure	Solutions
	PG feedback loss	Check the PG feedback connection.
	PG feedback stall	Check the PG feedback connection.
	PG feedback slip error	Check if the PI gain and the acceleration/deceleration settings are proper. Return to factory for repair.
	PG Card information error	Check if the setting value of the Parameter 01-26 matches the installed PG Card. For details, please refer to the description of Parameter 01-26. If there is no error found, please return it to factory for repair.
	Safe circuit card/control board jumper JP18 has improper installation or faulty activation	Check if the safety circuit card is installed correctly in the control board and the output action for any fault. Check the control board jumper JP18 for incorrect position.
	Over pressure	Check if the pressure sensor for any fault. Adjust the pressure PI control parameters 00-20~00-37
	Pressure feedback loss	Check if the wiring of the pressure sensor is correct. Check if the signal of the pressure sensor is lower than 1V.

Alarm Reset

After the cause of the alarm is cleared from the tripped state, press the RESET button on the keypad (as shown in the figure), set the external terminal as a "Error Reset Command" and then connect the terminal, or send error reset command through the communication port to release the tripped state of the machine. Before rest any error alarm, the operation signal should be open (OFF) so as to prevent the sudden running of the machine immediately after the recovery from error signal and causing damage or injury.

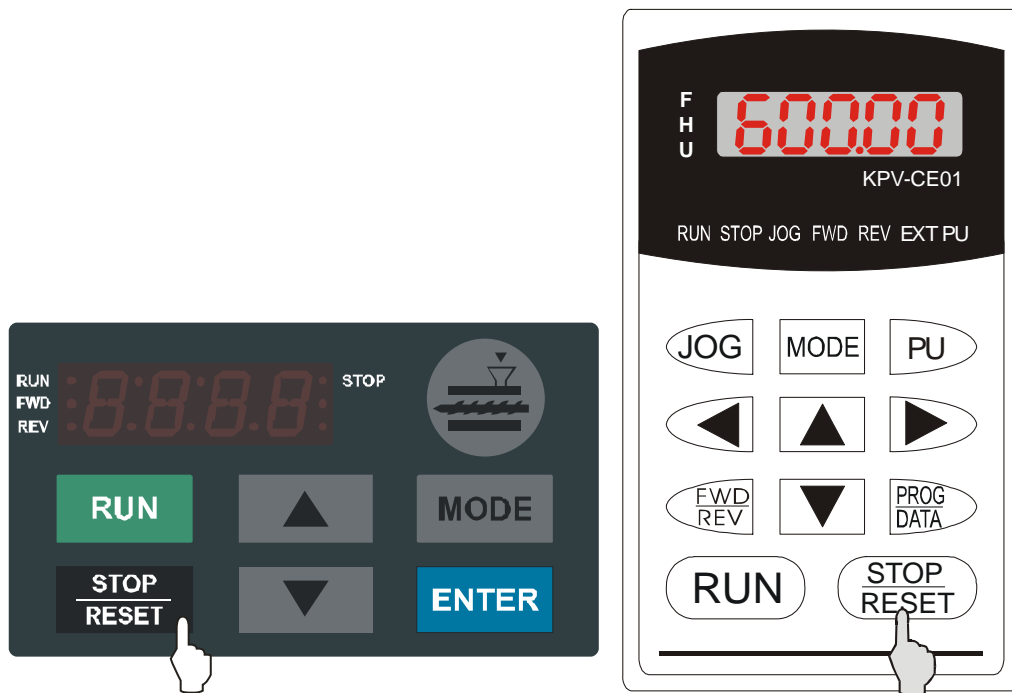

5-2 Over Current oc

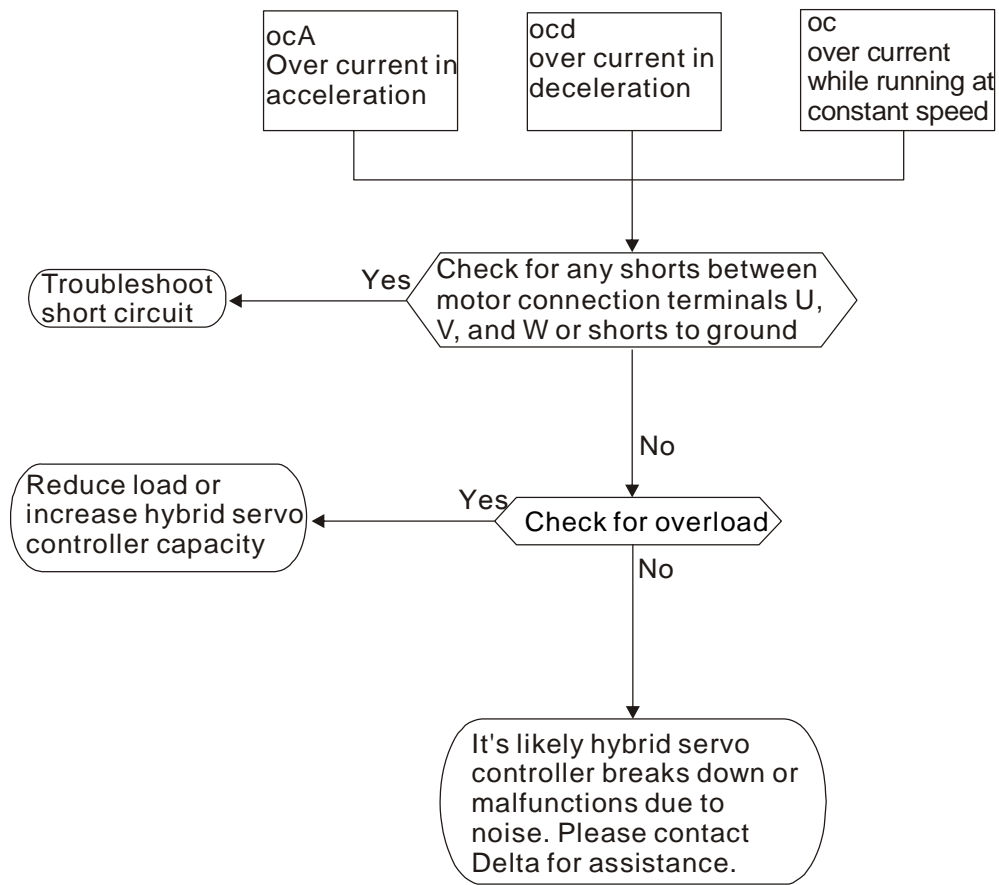

Hybrid servo controller -> Hybrid servo drive

5-3 Ground Fault Factor GFF

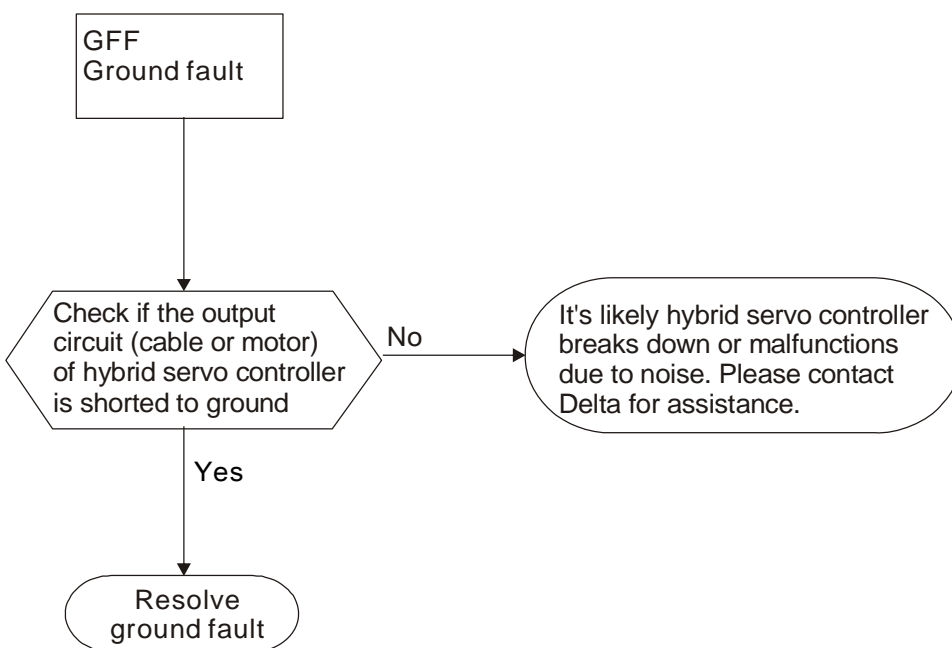

Hybrid servo controller -> Hybrid servo drive

5-4 Over Voltage ov

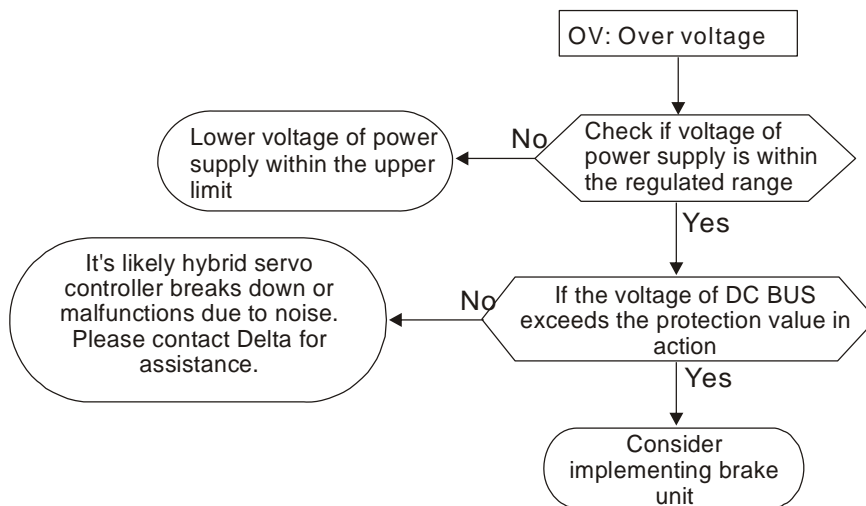

Hybrid servo controller -> Hybrid servo drive

5-5 Low Voltage Lv

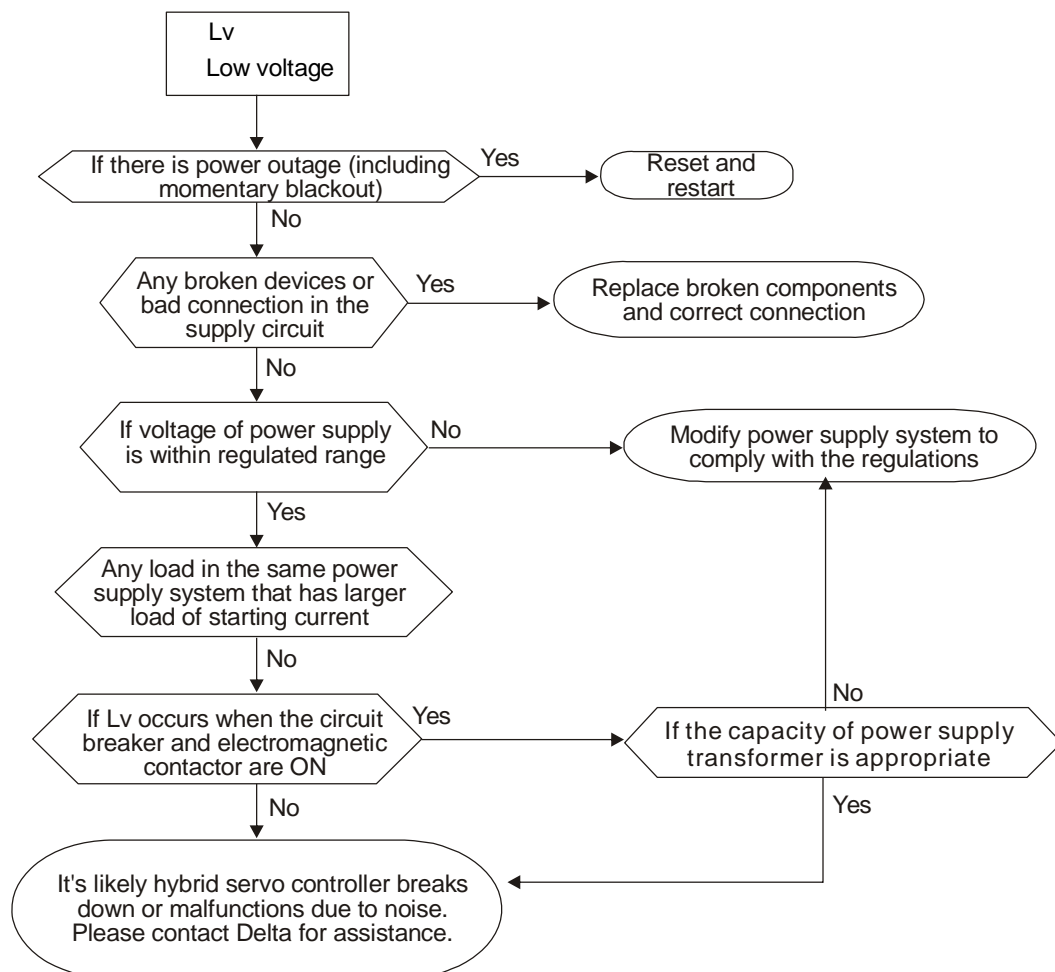

Hybrid servo controller -> Hybrid servo drive

5-6 Over Heating oH1

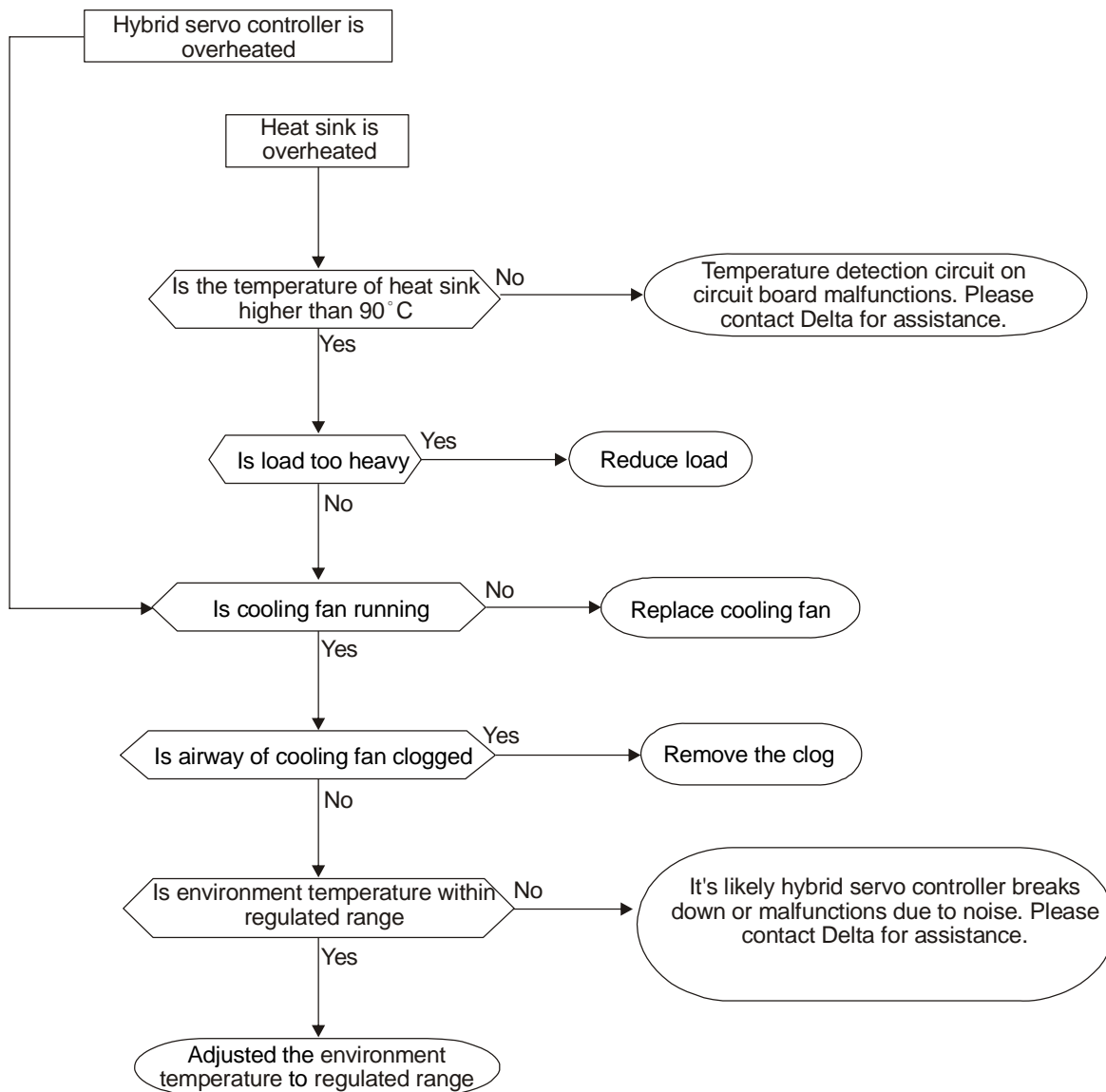

Hybrid servo controller -> Hybrid servo drive

5-7 Over Load oL

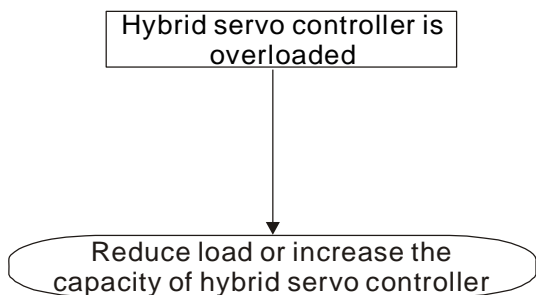

Hybrid servo controller -> Hybrid servo drive

5-8 Phase Loss PHL

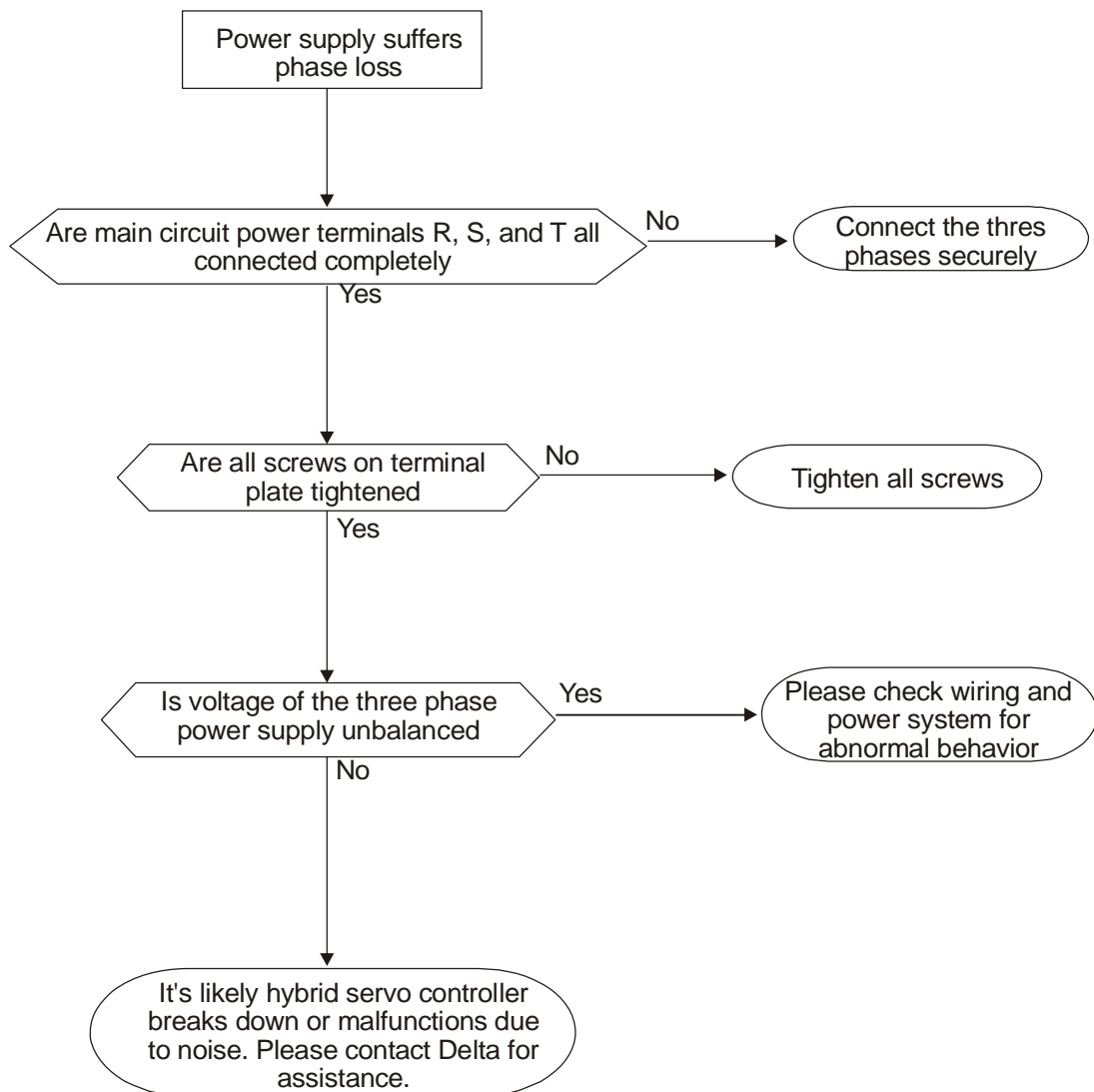

Hybrid servo controller -> Hybrid servo drive

5-9 Electromagnetic/Induction Noise

There are many noises surround the Hybrid servo drive and invade it by radiation or power circuit. It may cause the misoperation of control circuit and even damage the Hybrid servo drive. Of course, that is a solution to increase the noise tolerance of the Hybrid servo drive. But it is not the best one due to the limit. Therefore, solve it from the outside as following will be the best.

1. Add surge killer on the relay or contact to suppress switching surge between ON/OFF.
2. Shorten the wiring length of the control circuit or serial circuit and separate from the main circuit wiring.
3. Comply with the wiring regulation for those shielded wire and use isolation amplifier for long wire.
4. The grounding terminal should comply with the local regulation and ground independently, i.e. not to have common ground with electric welding machine and power equipment.
5. Connect a noise filter at the input terminal of the Hybrid servo drive to prevent noise from power circuit.

In a word, three-level solutions for electromagnetic noise are “no product”, “no spread” and “no receive”.

5-10 Environmental Condition

Since Hybrid servo drive is an electronic device, you should comply with the environmental condition stated in the appendix A. Following are the remedial measures for necessary.

6. To prevent vibration, anti-vibration spacer is the last choice. The vibration tolerance must be within the specification. The vibration effect is equal to the mechanical stress and it cannot occur frequently, continuously or repeatedly to prevent damaging Hybrid servo drive.
7. Store in a clean and dry location free from corrosive fumes/dust to prevent rustiness, poor contact. It also may cause short by low insulation in a humid location. The solution is to use both paint and dust-proof. For particular occasion, use the enclosure with whole-seal structure.
8. The surrounding temperature should be within the specification. Too high or low temperature will affect the lifetime and reliability. For semiconductor components, damage will occur once any specification is out of range. Therefore, it is necessary to clean and periodical check for the air cleaner and cooling fan besides having cooler and sunshade. In additional, the microcomputer may not work in extreme low temperature and needs to have heater.
 1. Store within a relative humidity range of 0% to 90% and non-condensing environment. Do not turn off the air conditioner and have exsiccator for it.

6. Suggestions and Error Corrections for Hybrid Servo Drives

6-1 Maintenance and Inspections

6-2 Greasy Dirt Problem

6-3 Fiber Dust Problem

6-4 Erosion Problem

6-5 Industrial Dust Problem

6-6 Wiring and Installation Problem

6-7 Multi-function Input/Output Terminals Problem

The Hybrid servo drive has a comprehensive fault diagnostic system that includes several different alarms and fault messages. Once a fault is detected, the corresponding protective functions will be activated. The following faults are displayed as shown on the Hybrid servo drive digital keypad display. The six most recent faults can be read from the digital keypad or communication.

The Hybrid servo drive is made up by numerous components, such as electronic components, including IC, resistor, capacity, transistor, and cooling fan, relay, etc. These components can't be used permanently. They have limited-life even under normal operation. Preventive maintenance is required to operate this Hybrid servo drive in its optimal condition, and to ensure a long life.

Check your Hybrid servo drive regularly to ensure there are no abnormalities during operation and follows the precautions:



- ☑ Wait 5 seconds after a fault has been cleared before performing reset via keypad of input terminal.
- ☑ When the power is off after 5 minutes for $\leq 22\text{kW}$ models and 10 minutes for $\geq 30\text{kW}$ models, please confirm that the capacitors have fully discharged by measuring the voltage between + and -. The voltage between + and - should be less than 25VDC.
- ☑ Only qualified personnel can install, wire and maintain drives. Please take off any metal objects, such as watches and rings, before operation. And only insulated tools are allowed.
- ☑ Never reassemble internal components or wiring.
- ☑ Make sure that installation environment comply with regulations without abnormal noise, vibration and smell.

6-1 Maintenance and Inspections

Before the check-up, always turn off the AC input power and remove the cover. Wait at least 10 minutes after all display lamps have gone out, and then confirm that the capacitors have fully discharged by measuring the voltage between DC+ and DC-. The voltage between DC+ and DC- should be less than 25VDC.

Ambient environment

Check Items	Methods and Criterion	Maintenance Period		
		Daily	Half Year	One Year
Check the ambient temperature, humidity, vibration and see if there are any dust, gas, oil or water drops	Visual inspection and measurement with equipment with standard specification	<input type="radio"/>		
If there are any dangerous objects	Visual inspection	<input type="radio"/>		

Voltage

Check Items	Methods and Criterion	Maintenance Period		
		Daily	Half Year	One Year
Check if the voltage of main circuit and control circuit is correct	Measure with multimeter with standard specification	<input type="radio"/>		

Digital Keypad Display

Check Items	Methods and Criterion	Maintenance Period		
		Daily	Half Year	One Year
Is the display clear for reading	Visual inspection	<input type="radio"/>		
Any missing characters	Visual inspection	<input type="radio"/>		

Mechanical parts

Check Items	Methods and Criterion	Maintenance Period		
		Daily	Half Year	One Year
If there is any abnormal sound or vibration	Visual and aural inspection		<input type="radio"/>	
If there are any loose screws	Tighten the screws		<input type="radio"/>	
If any part is deformed or damaged	Visual inspection		<input type="radio"/>	
If there is any color change by overheating	Visual inspection		<input type="radio"/>	
If there is any dust or dirt	Visual inspection		<input type="radio"/>	

Main circuit

Check Items	Methods and Criterion	Maintenance Period		
		Daily	Half Year	One Year
If there are any loose or missing screws	Tighten or replace the screw	<input type="radio"/>		
If machine or insulator is deformed, cracked, damaged or with color change due to overheating or ageing	Visual inspection NOTE: Please ignore the color change of copper plate		<input type="radio"/>	
If there is any dust or dirt	Visual inspection		<input type="radio"/>	

Terminals and wiring of main circuit

Check Items	Methods and Criterion	Maintenance Period		
		Daily	Half Year	One Year
If the terminal or the plate is color change or deformation due to overheat	Visual inspection		<input type="radio"/>	
If the insulator of wiring is damaged or color change	Visual inspection		<input type="radio"/>	
If there is any damage	Visual inspection	<input type="radio"/>		

DC capacity of main circuit

Check Items	Methods and Criterion	Maintenance Period		
		Daily	Half Year	One Year
If there is any leak of liquid, color change, crack or deformation	Visual inspection	<input type="radio"/>		
If the safety valve is not removed? If valve is inflated?	Visual inspection	<input type="radio"/>		
Measure static capacity when required		<input type="radio"/>		

Resistor of main circuit

Check Items	Methods and Criterion	Maintenance Period		
		Daily	Half Year	One Year
If there is any peculiar smell or insulator cracks due to overheat	Visual inspection, smell	<input type="radio"/>		
If there is any disconnection	Visual inspection	<input type="radio"/>		
If connection is damaged?	Measure with multimeter with standard specification	<input type="radio"/>		

Transformer and reactor of main circuit

Check Items	Methods and Criterion	Maintenance Period		
		Daily	Half Year	One Year
If there is any abnormal vibration or peculiar smell	Visual, aural inspection and smell	<input type="radio"/>		

Magnetic contactor and relay of main circuit

Check Items	Methods and Criterion	Maintenance Period		
		Daily	Half Year	One Year
If there are any loose screws	Visual and aural inspection	<input type="radio"/>		
If the contact works correctly	Visual inspection	<input type="radio"/>		

Printed circuit board and connector of main circuit

Check Items	Methods and Criterion	Maintenance Period		
		Daily	Half Year	One Year
If there are any loose screws and connectors	Tighten the screws and press the connectors firmly in place.		<input type="radio"/>	
If there is any peculiar smell and color change	Visual and smell inspection		<input type="radio"/>	
If there is any crack, damage, deformation or corrosion	Visual inspection		<input type="radio"/>	
If there is any liquid is leaked or deformation in capacity	Visual inspection		<input type="radio"/>	

Cooling fan of cooling system

Check Items	Methods and Criterion	Maintenance Period		
		Daily	Half Year	One Year
If there is any abnormal sound or vibration	Visual, aural inspection and turn the fan with hand (turn off the power before operation) to see if it rotates smoothly		<input type="radio"/>	
If there is any loose screw	Tighten the screw		<input type="radio"/>	
If there is any color change due to overheat	Change fan		<input type="radio"/>	

Ventilation channel of cooling system

Check Items	Methods and Criterion	Maintenance Period		
		Daily	Half Year	One Year
If there is any obstruction in the heat sink, air intake or air outlet	Visual inspection		○	

 **NOTE**

Please use the neutral cloth for clean and use dust cleaner to remove dust when necessary.

6-2 Greasy Dirt Problem

Serious greasy dirt problems generally occur in processing industries such as machine tools, punching machines and so on. Please be aware of the possible damages that greasy oil may cause to your drive:

1. Electronic components that silt up with greasy oil may cause the drive to burn out or even explode.
2. Most greasy dirt contains corrosive substances that may damage the drive.

Solution:

Install the Hybrid servo drive in a standard cabinet to keep it away from dirt. Clean and remove greasy dirt regularly to prevent damage of the drive.

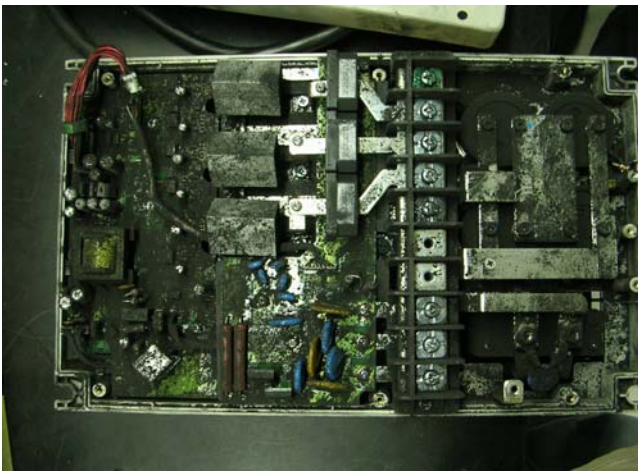

6-3 Fiber Dust Problem

Serious fiber dust problems generally occur in the textile industry. Please be aware of the possible damages that fiber may cause to your drives:

1. Fiber that accumulates or adheres to the fans will lead to poor ventilation and cause overheating problems.
2. Plant environments in the textile industry have higher degrees of humidity that may cause the drive to burn out, become damaged or explode due to wet fiber dust adhering to the devices.

Solution:

Install the Hybrid servo drive in a standard cabinet to keep it away from fiber dust. Clean and remove fiber dust regularly to prevent damage to the drive.

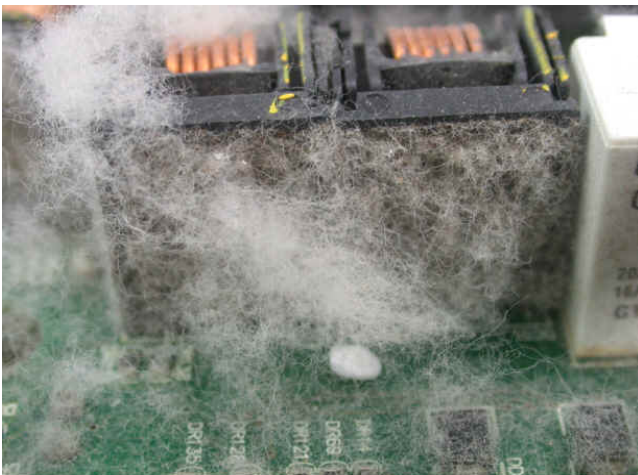

6-4 Erosion Problem

Erosion problems may occur if any fluids flow into the drives. Please be aware of the damages that erosion may cause to your drive.

1. Erosion of internal components may cause the drive to malfunction and possibility to explode.

Solution:

Install the Hybrid servo drive in a standard cabinet to keep it away from fluids. Clean the drive regularly to prevent erosion.

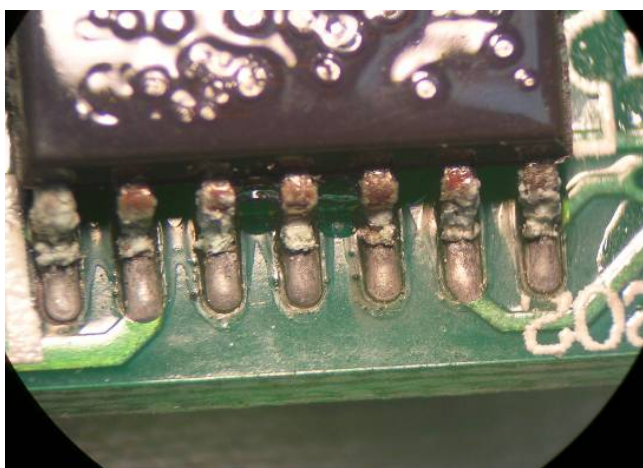
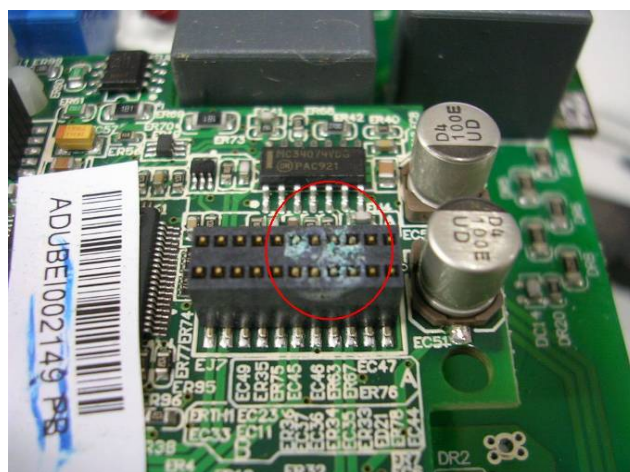
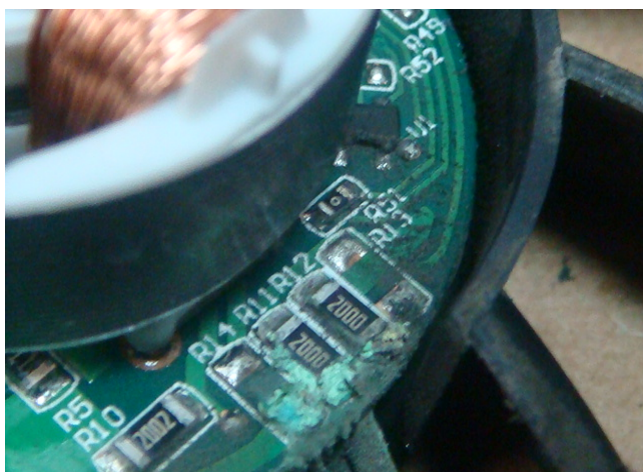

6-5 Industrial Dust Problem

Serious industrial dust pollution frequently occurs in stone processing plants, flour mills, cement plants, and so on. Please be aware of the possible damage that industrial dust may cause to your drives:

1. Dust accumulating on electronic components may cause overheating problem and shorten the service life of the drive.
2. Conductive dust may damage the circuit board and may even cause the drive to explode.

Solution:

Install the Hybrid servo drive in a standard cabinet and cover the drive with a dust cover. Clean the cabinet and ventilation hole regularly for good ventilation.

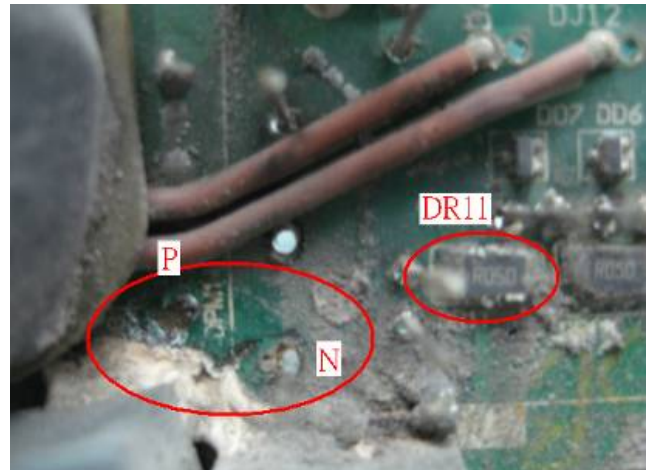
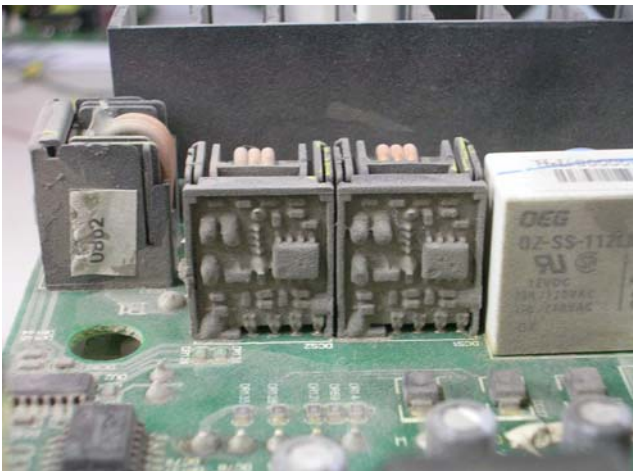

6-6 Wiring and Installation Problem

When wiring the drive, the most common problem is wrong wire installation or poor wiring. Please be aware of the possible damages that poor wiring may cause to your drives:

1. Screws are not fully fastened. Occurrence of sparks as impedance increases.
2. If a customer has opened the drive and modified the internal circuit board, the internal components may have been damaged.

Solution:

Ensure all screws are fastened when installing the Hybrid servo drive. If the Hybrid servo drive functions abnormally, send it back to the repair station. **DO NOT** try to reassemble the internal components or wire.

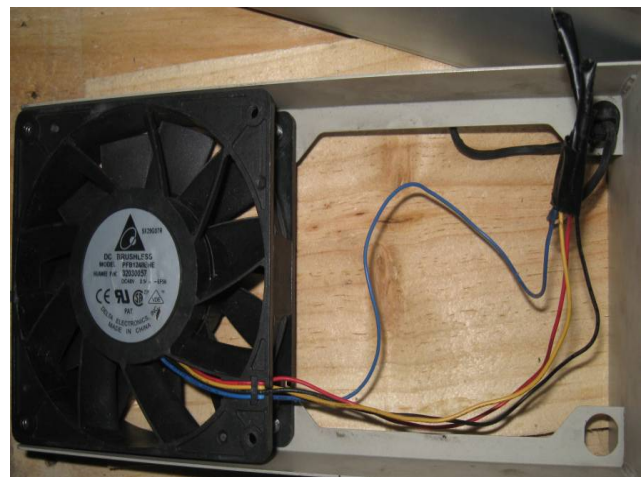
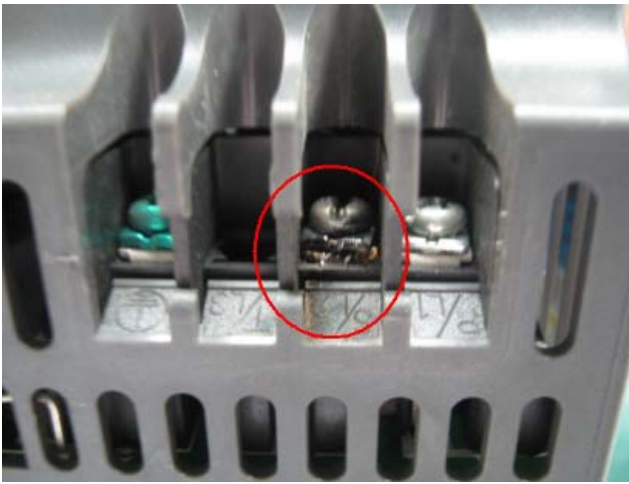

6-7 Multi-function Input/Output Terminals Problem

Multi-function input/output terminal errors are generally caused by over usage of terminals and not following specifications. Please be aware of the possible damages that errors on multi-function input/output terminals may cause to your drives:

1. Input/output circuit may burn out when the terminal usage exceeds its limit.

Solution:

Refer to the user manual for multi-function input output terminals usage and follow the specified voltage and current. DO NOT exceed the specification limits.

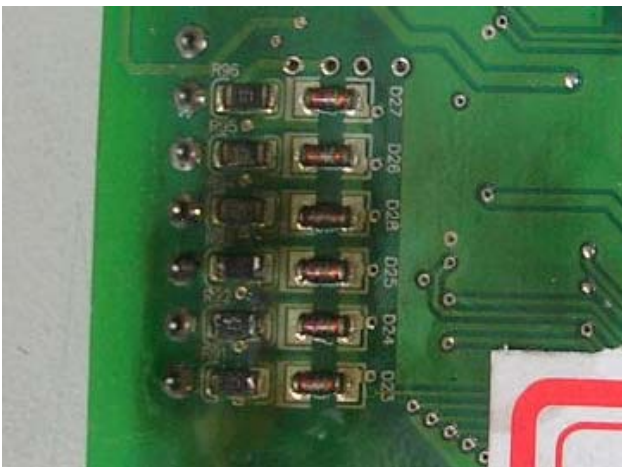
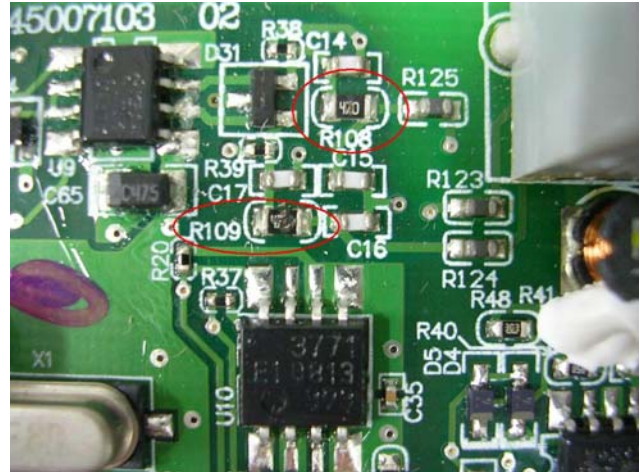
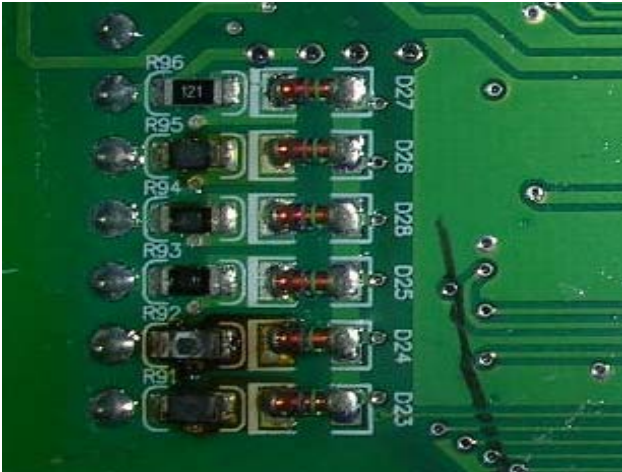

Appendix A Optional Accessories

- A-1 Braking Resistor Selection Chart
- A-2 Non-fuse Circuit Breaker
- A-3 Fuse Specification
- A-4 Reactor
- A-5 Digital Keypad KPV-CE01
- A-6 Speed Feedback PG Card Selection
- A-7 Communication Card
- A-8 EMI Filter



- This Hybrid servo drive has gone through rigorous quality control tests at the factory before shipment. If the package is damaged during shipping, please contact your dealer.
- The accessories produced by Delta are only for using with Delta Hybrid servo drive. Do NOT use with other drive to prevent damage.

A-1 Braking Resistor Selection Chart

230V

Applicable Motor	* ¹ 125% Braking Torque 10%ED					Maximum Braking Torque Limit			
Model	brake torque (kg-m)	Braking Unit	Braking Resistor Models for the Corresponding Brake Unit * ²		Effective Braking Resistance of Each Drive	Total Braking Current (A)	Minimum Resistance Limit (Ω)	Highest Total Braking Current Limit (A)	Maximum Peak Power (kW)
		VFDB * ³							
VFD055VL23A-J	3.7	-	BR1K0W020*1		1000W20Ω	19	15.6	24.4	9.3
VFD075VL23A-J	5.1	-	BR1K5W013*1		1500W13Ω	29	11.5	33.0	12.5
VFD110VL23A-J	7.4	-	BR1K5W013*1		1500W13Ω	29	9.5	40.0	15.2
VFD150VL23A-J	10.2	-	BR1K0W4P3*2	2 in series	2000W8.6Ω	44	8.3	46.0	17.5
VFD185VL23A-J	12.2	-	BR1K2W3P9*2	2 in series	2400W7.8Ω	49	5.8	66.0	25.1
VFD220VL23A-J	14.9	-	BR1K5W3P3*2	2 in series	3000W6.6Ω	58	5.8	66.0	25.1
VFD300VL23A-J	20.3	2015*2	BR1K0W5P1*2	2 in series	4000W5.1Ω	75	4.8	80.0	30.4
VFD370VL23A-J	25.0	2022*2	BR1K2W3P9*2	2 in series	4800W3.9Ω	97	3.2	120.0	45.6

460V

Applicable Motor	* ¹ 125% Braking Torque 10%ED					Maximum Braking Torque Limit			
Model	brake torque (kg-m)	Braking Unit	Braking Resistor Models for the Corresponding Brake Unit * ²		Effective Braking Resistance of Each Drive	Total Braking Current (A)	Minimum Resistance Limit (Ω)	Highest Total Braking Current Limit (A)	Maximum Peak Power (kW)
		VFDB * ³							
VFD055VL43A-J	3.7	-	BR1K0W075*1		1000W75Ω	10.2	48.4	15.7	11.9
VFD075VL43A-J	5.1	-	BR1K5W043*1		1500W43Ω	17.6	39.4	19.3	14.7
VFD110VL43A-J	7.4	-	BR1K5W043*1		1500W43Ω	17.6	30.8	24.7	18.8
VFD150VL43A-J VFD150VL43B-J	10.2	-	BR1K0W016*2	2 in series	2000W32Ω	24	25.0	30.4	23.1
VFD185VL43A-J VFD185VL43B-J	12.2	-	BR1K5W013*2	2 in series	3000W26Ω	29	20.8	36.5	27.7
VFD220VL43A-J	14.9	-	BR1K5W013*2	2 in series	3000W26Ω	29	19.0	40.0	30.4
VFD300VL43B-J	20.3	4030*1	BR1K0W016*4	2 in parallel 2 in series	4000W16Ω	47.5	14.1	54.0	41.0
VFD300VL43A-J	20.3	4045*1	BR1K0W5P1*4	4 in series	4000W20.4Ω	37	19.0	40.0	30.4
VFD370VL43A-J VFD370VL43B-J	25.0	4045*1	BR1K2W015*4	2 in parallel 2 in series	4800W15Ω	50	12.7	60.0	45.6
VFD450VL43A-J VFD450VL43B-J	30.5	4030*2	BR1K5W013*4	2 in parallel 2 in series	6000W13Ω	59	12.7	60.0	45.6
VFD550VL43A-J	37.2	4045*2	BR1K0W5P1*4	4 in series	7200W10Ω	76	9.5	80.0	60.8
VFD750VL43A-J	50.8	4030*1	BR1K2W015*4	2 in parallel 2 in series	9600W7.5Ω	100	6.3	120.0	91.2

*¹ Calculation for 125% brake torque: (kw)*125%*0.8; where 0.8 is motor efficiency.

Because there is a resistor limit of power consumption, the longest operation time for 10%ED is 10sec (on: 10sec/ off: 90sec).

*² For heat dissipation, a resistor of 400W or lower should be fixed to the frame and maintain the surface temperature below 50 °C; a resistor of 1000W and above should maintain the surface temperature below 350 °C.

*³ Please refer to VFDB series Braking Module Instruction for more detail on braking resistor.

NOTE

1. Definition for Brake Usage ED%:

Explanation: The definition of the brake usage ED (%) is for assurance of enough time for the brake unit and brake resistor to dissipate away heat generated by braking. When the brake resistor heats up, the resistance would increase with temperature, and brake torque would decrease accordingly. Recommended cycle time is one minute.

Definition of Brake Usage ED%

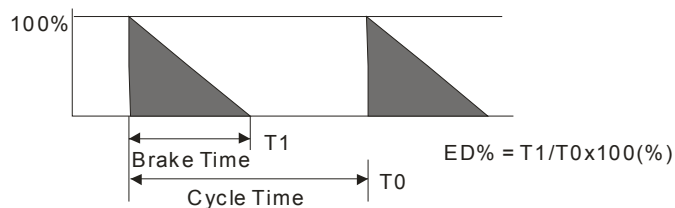

For safety concern, install an overload relay (O.L) between the brake unit and the brake resistor in conjunction with the magnetic contactor (MC) prior to the drive for abnormal protection. The purpose of installing the thermal overload relay is to protect the brake resistor from damage due to frequent brake, or due to brake unit keeping operating resulted from unusual high input voltage. Under such circumstance, just turn off the power to prevent damaging the brake resistor.

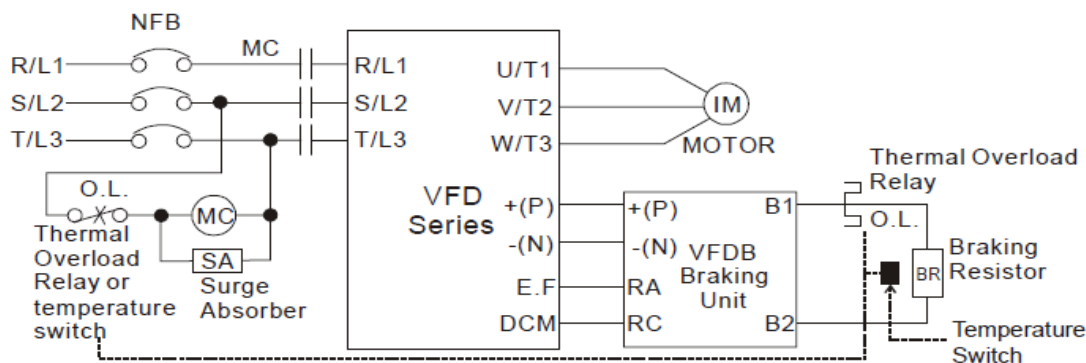

Note 1: When using the AC drive with DC reactor, please refer to wiring diagram in the AC drive user manual for the wiring of terminal +(P) of Braking unit.

Note 2: Do NOT wire terminal -(N) to the neutral point of power system.

2. If damage to the drive or other equipment is due to the fact that the brake resistors and brake modules in use are not provided by Delta, the warranty will be void.
3. Take into consideration the safety of the environment when installing the brake resistors. If the minimum resistance value is to be utilized, consult local dealers for the calculation of Watt figures.
4. When using more than 2 brake units, equivalent resistor value of parallel brake unit can't be less than the value in the column "Minimum Equivalent Resistor Value for Each Hybrid Servo Drive" (the right-most column in the table). Please read the wiring information in the user manual of brake unit thoroughly prior to operation.
5. This chart is for normal usage; if the Hybrid servo drive is applied for frequent braking, it is suggested to enlarge 2~3 times of the Watts.
6. The position to install OOO needs to be at least 15cm away from the motor drive.

Specifications of VFDB Brake Unit

Voltage Rating		230V Series		460V Series	
Model No. VFDB-□□□□		2015	2022	4030	4045
Maximum applicable motor capacity (KW)		15	22	30	45
Output Rating	Peak Discharge Current (I _{peak})10ED%	40	60	40	60
	Continuous Discharge Current (A)	15	20	15	18
	Braking Start Voltage (DC)	330/345/360/380/400/415±3V		660/690/720/760/800/415±3V	
Power Supply	DC Voltage	200~400VDC		400~800VDC	
Protection	Over Heating of Heat Sink	Temperature Switch +95°C			
	Fault output	Relay Contact 5A120Vac/28Vdc(RA.RB.RC)			
	Charge Indication	It goes off when the main loop (P-N) voltage is below 50VDC			
Environment	Installation Location	Indoor (no corrosive gases or metal dusts)			
	Ambient temperature	-10°C~+50°C			
	Storage Temperature	-20°C~+60°C			
	Humidity	Non-condensing below 90%RH			
	Vibration	9.8m/S ² (1G) for < 20Hz, 2m/S ² (0.2G) for 20 – 50Hz			
Mechanical Construction		Wall Mount IP50			

Dimensions of Brake Unit

Brake Unit: VFDB2015, VFDB2022, VFDB4030, and VFDB4045

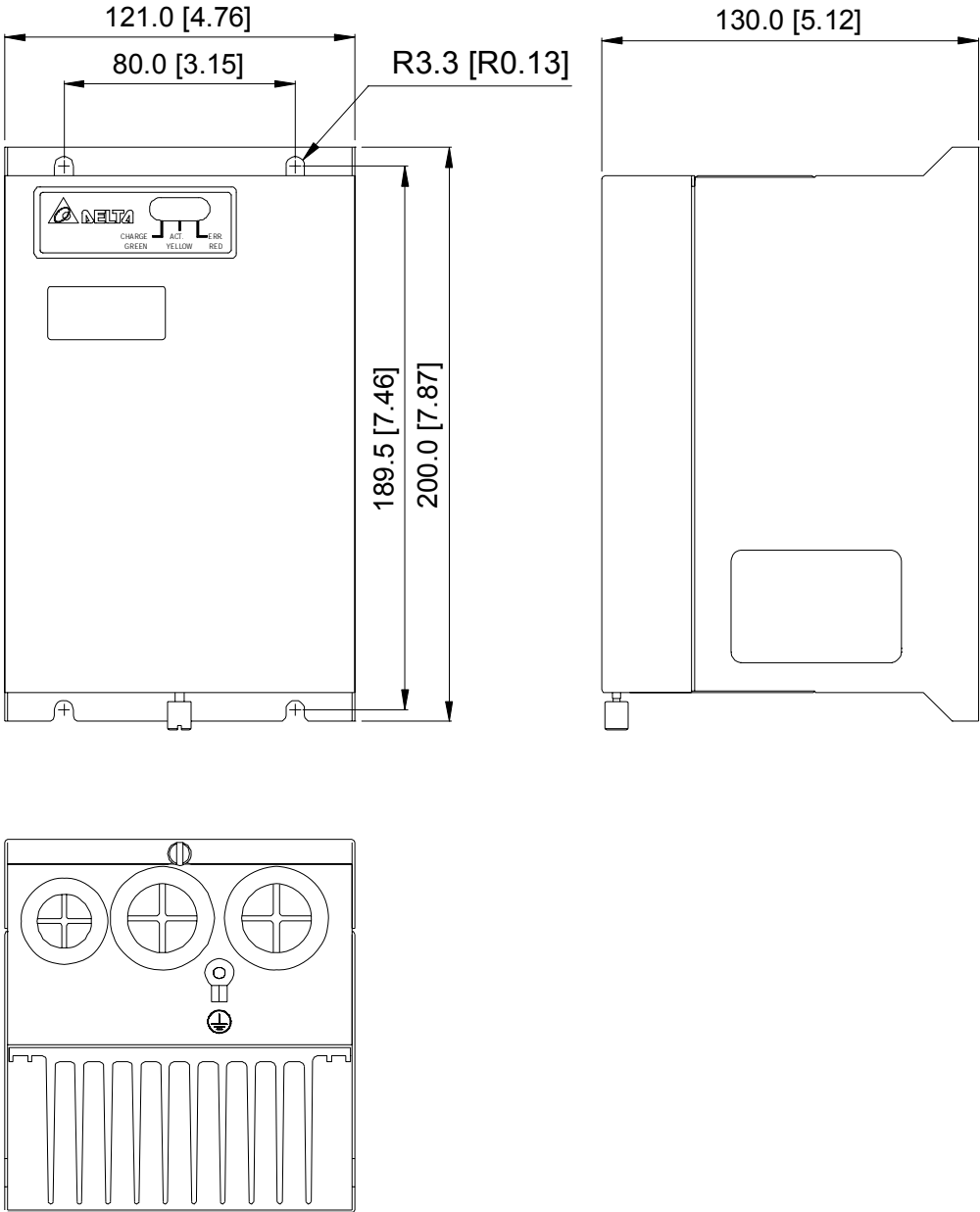

A-2 Non-fuse Circuit Breaker

Comply with UL standard: Per UL 508, paragraph 45.8.4, part a,

The rated current of the breaker shall be 2~4 times of the maximum rated input current of Hybrid servo drive.

Three-phase	
Model	Recommended Current (A)
VFD055VL23A-J	50
VFD055VL43A-J	30
VFD075VL23A-J	60
VFD075VL43A-J	40
VFD110VL23A-J	100
VFD110VL43A-J	50
VFD150VL23A-J	125
VFD150VL43A-J	60
VFD185VL23A-J	150
VFD185VL43A-J	75

Three-phase	
Model	Recommended Current (A)
VFD220VL23A-J	175
VFD220VL43A-J	100
VFD300VL23A-J	225
VFD300VL43A-J	125
VFD370VL23A-J	250
VFD370VL43A-J	150
VFD450VL43A-J	175
VFD550VL43A-J	250
VFD750VL43A-J	300

A-3 Fuse Specifications

Smaller fuses than those shown in the table are permitted

230V Series	Input Current I (A)	Line Fuse	
		I (A)	Bussmann P/N
VFD055VL23A-J	25	50	JJN-50
VFD075VL23A-J	31	60	JJN-60
VFD110VL23A-J	47	100	JJN-100
VFD150VL23A-J	60	125	JJN-125
VFD185VL23A-J	80	150	JJN-150
VFD220VL23A-J	90	175	JJN-175
VFD300VL23A-J	106	225	JJN-225
VFD370VL23A-J	126	250	JJN-250

460V Series	Input Current I (A)	Line Fuse	
		I (A)	Bussmann P/N
VFD055VL43A-J	14	30	JJN-30
VFD075VL43A-J	18	40	JJN-40
VFD110VL43A-J	24	50	JJN-50
VFD150VL43A-J	31	60	JJN-60
VFD185VL43A-J	39	75	JJN-70
VFD220VL43A-J	47	100	JJN-100
VFD300VL43A-J	56	125	JJN-125
VFD370VL43A-J	67	150	JJN-150
VFD450VL43A-J	87	175	JJN-175
VFD550VL43A-J	101	250	JJN-250
VFD750VL43A-J	122	300	JJN-300

A-4 Reactor

A-4-1 AC Input Reactor Recommended Value

460V, 50/60Hz, Three-phase

kW	HP	Rated Current of Reactor	Maximum Continuous Current	Inductance (mh)	
				3% Impedance	5% Impedance
5.5	7.5	12	18	2.5	4.2
7.5	10	18	27	1.5	2.5
11	15	25	37.5	1.2	2
15	20	35	52.5	0.8	1.2
18.5	25	35	52.5	0.8	1.2
22	30	45	67.5	0.7	1.2
30	40	55	82.5	0.5	0.85
37	50	80	120	0.4	0.7
45	60	80	120	0.4	0.7
55	75	100	150	0.3	0.45
75	100	130	195	0.2	0.3

A-4-2 AC Output Reactor Recommended Value

230V, 50/60Hz, Three-phase

kW	HP	Rated Current of Reactor	Maximum Continuous Current	Inductance (mh)	
				3% Impedance	5% Impedance
5.5	7.5	25	37.5	0.5	1.2
7.5	10	35	52.5	0.4	0.8
11	15	55	82.5	0.25	0.5
15	20	80	120	0.2	0.4
18.5	25	80	120	0.2	0.4
22	30	100	150	0.15	0.3
30	40	130	195	0.1	0.2
37	50	160	240	0.075	0.15

460V, 50/60Hz, Three-phase

kW	HP	Rated Current of Reactor	Maximum Continuous Current	Inductance (mh)	
				3% Impedance	5% Impedance

5.5	7.5	18	27	1.5	2.5
7.5	10	18	27	1.5	2.5
11	15	25	37.5	1.2	2
15	20	35	52.5	0.8	1.2
18.5	25	45	67.5	0.7	1.2
22	30	45	67.5	0.7	1.2
30	40	80	120	0.4	0.7
37	50	80	120	0.4	0.7
45	60	100	150	0.3	0.45
55	75	130	195	0.2	0.3
75	100	160	240	0.15	0.23

Application Example of AC Reactor

Connected in input circuit

Application 1

When more than one Hybrid drive is connected to the same mains power, and one of them is ON during operation.

Problem: When applying power to one of the Hybrid drive, the charge current of the capacitors may cause voltage dip. The Hybrid drive may be damaged when over current occurs during operation.

Correct wiring:

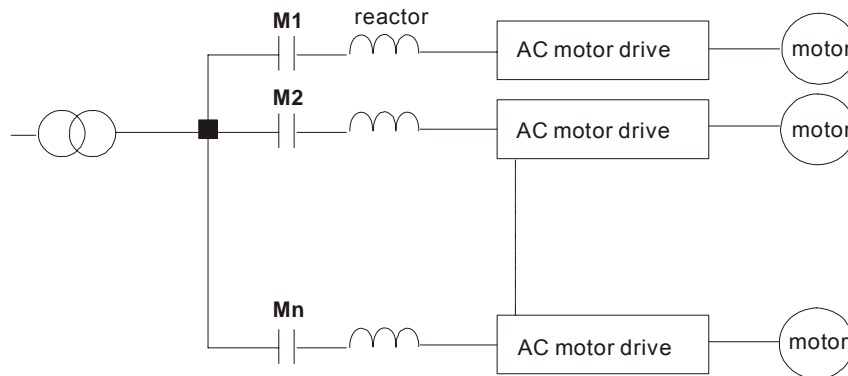

Application 2

Silicon rectifier and Hybrid drive are connected to the same power.

Problem: Switching spikes will be generated when the silicon rectifier switches ON/OFF. These spikes may damage the mains circuit.

Correct wiring:

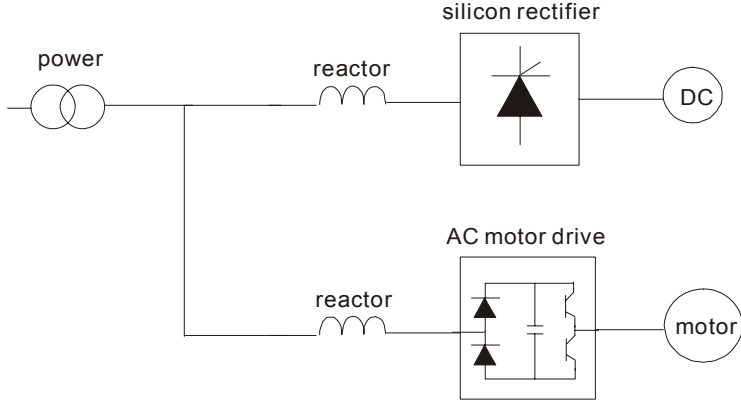

Application 3

When the power supply capacity exceeds 10 times of the inverter capacity.

Problem: When the mains power capacity is too large, line impedance will be small and the charge current will be too high. This may damage Hybrid drive due to higher rectifier temperature.

Correct wiring

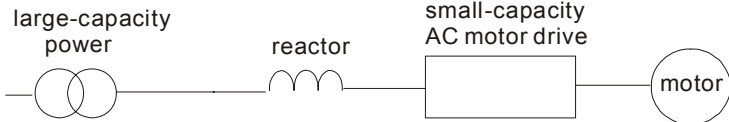

A-4-3 Zero-phase Reactor

RF220X00A

UNIT: mm (inch)

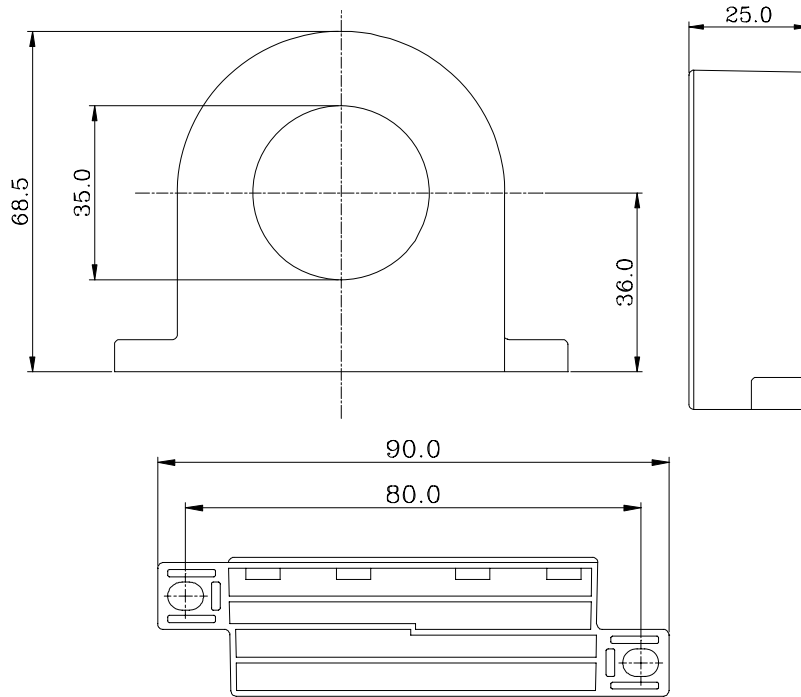

Cable Type (Note)	Recommended Wire Size (mm ²)			Qty.	Wiring Method
	AWG	mm ²	Nominal (mm ²)		
Single-core	≤10	≤5.3	≤5.5	1	Figure A
	≤2	≤33.6	≤38	3	Figure B
Three-core	≤12	≤3.3	≤3.5	1	Figure A
	≤1	≤42.4	≤50	3	Figure B

Figure A

Please wind each wire 3 times around the core. The reactor must be put at inverter output as close as possible.

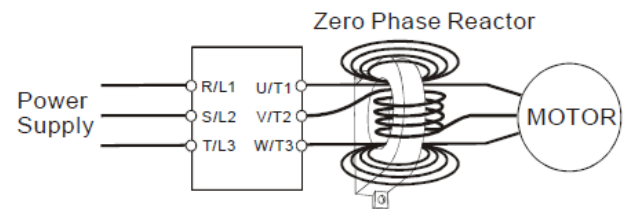
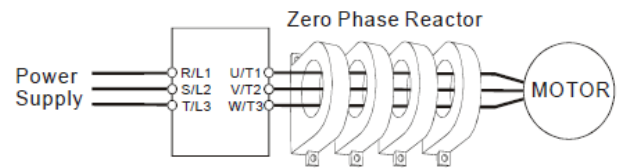

Figure B

Please put all wires through 3 cores in series without winding.



NOTE

600V insulated power line.

1. The table above gives approximate wire size for the zero phase reactors but the selection is ultimately governed by the type and diameter of cable fitted i.e. the cable must fit through the center hole of zero phase reactors.
2. Only the phase conductors should pass through, not the earth core or screen.
3. When long motor output cables are used an output zero phase reactor may be required to reduce radiated emissions from the cable.

A-4-4 DC Reactor

230V DC Choke

Input Voltage	kW	HP	DC Amps	Inductance (mh)
230Vac 50/60Hz 3-Phase	5.5	7.5	32	0.85
	7.5	10	40	0.75
	11	15	62	Built-in
	15	20	92	Built-in
	18.5	25	110	Built-in
	22	30	125	Built-in
	30	40	-	Built-in
	37	50	-	Built-in

460V DC Choke

Input Voltage	kW	HP	DC Amps	Inductance (mh)
460Vac 50/60Hz 3-Phase	5.5	7.5	18	3.75
	7.5	10	25	4.00
	11	15	32	Built-in
	15	20	50	Built-in
	18.5	25	62	Built-in
	22	30	80	Built-in
	30	40	92	Built-in
	37	50	110	Built-in
	45	60	125	Built-in
	55	75	200	Built-in
	75	100	240	Built-in

A-5 Digital Keypad KPV-CE01

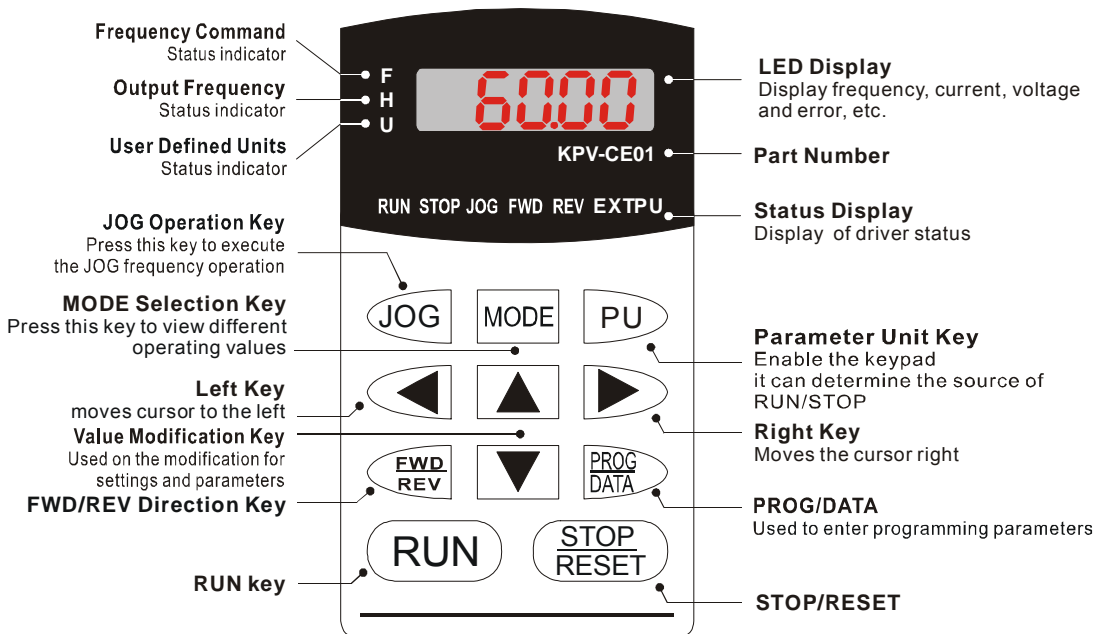

The VFD-VJ series products use the digital keypad VFD-KPV-CE01 as the display unit. For the actual keypad appearance, please refer to the actual product. This picture shows the schematic diagram for illustrative purposes only.

Keypad Panel Appearance



Description of Displayed Function Items

Displayed Item	Description
	Show the current frequency set for the Hybrid servo drive.
	Show the frequency Hybrid servo drive actually delivers to the motor.
	Show the user-defined physical value (U = F x 00-05)
	Show the load current
	Show the value of the counter
	Show the selected parameter
	Show the parameter value

	Show the external error
	If the message "End" is displayed (as shown in the left figure) for approximately 1 second, it means that the data have been accepted and automatically stored in the internal memory
	If the configured data are not accepted or the values exceed the limits, this message will be displayed

Keypad Panel Operation Process

Selection mode

START

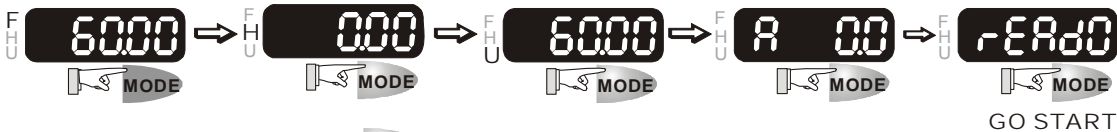

NOTE: In the selection mode, press  to set the parameters.

To set parameters

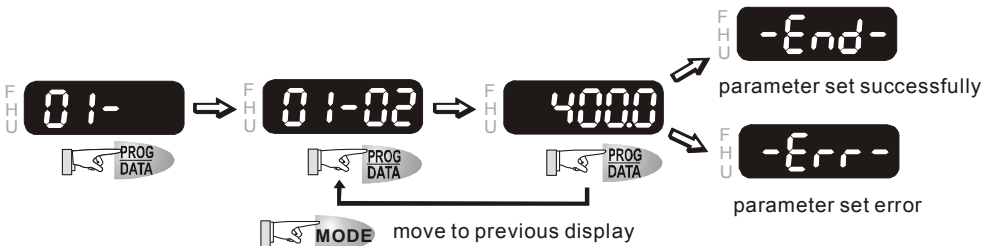

NOTE: In the parameter setting mode, you can press  to return to the selection mode.

To shift cursor

START



To modify data

START



To switch display mode

START

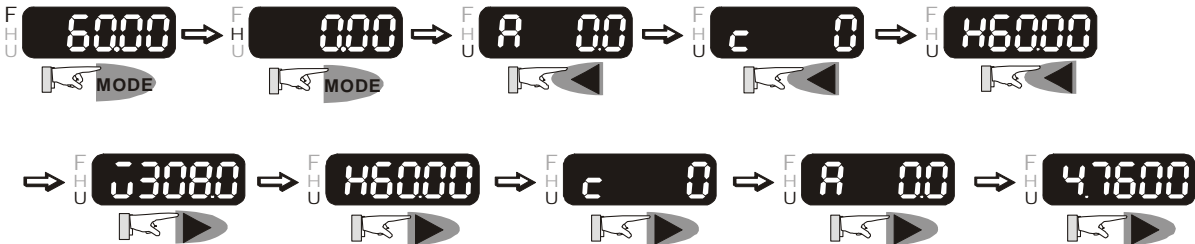

To copy parameters 1

Copy parameters from the AC Motor Drive to the KPV-CE01

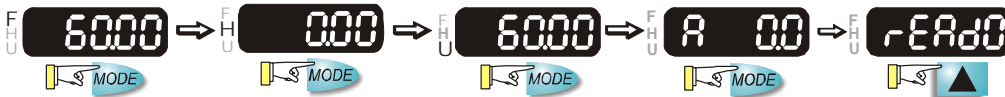
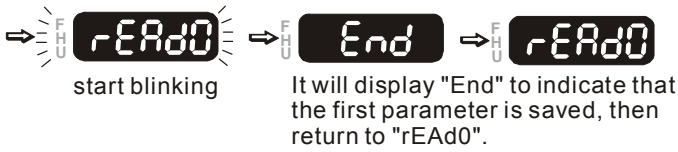
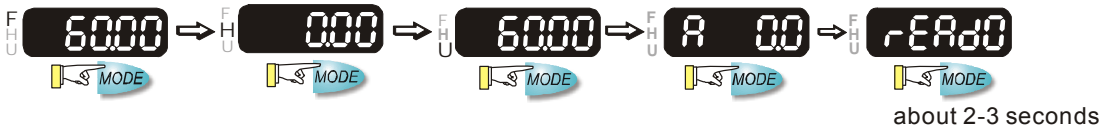

To copy parameters 2

Copy parameters from the KPV-CE01 to the AC Motor Drive

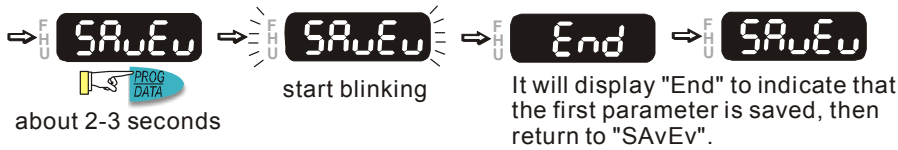
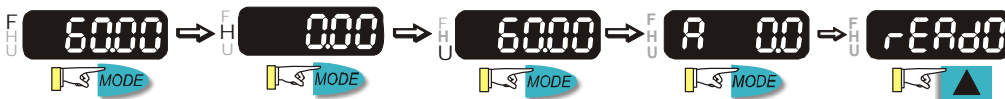

Mechanical Dimensions of Digital Keypad KPV-CE01

Unit: mm [inch]

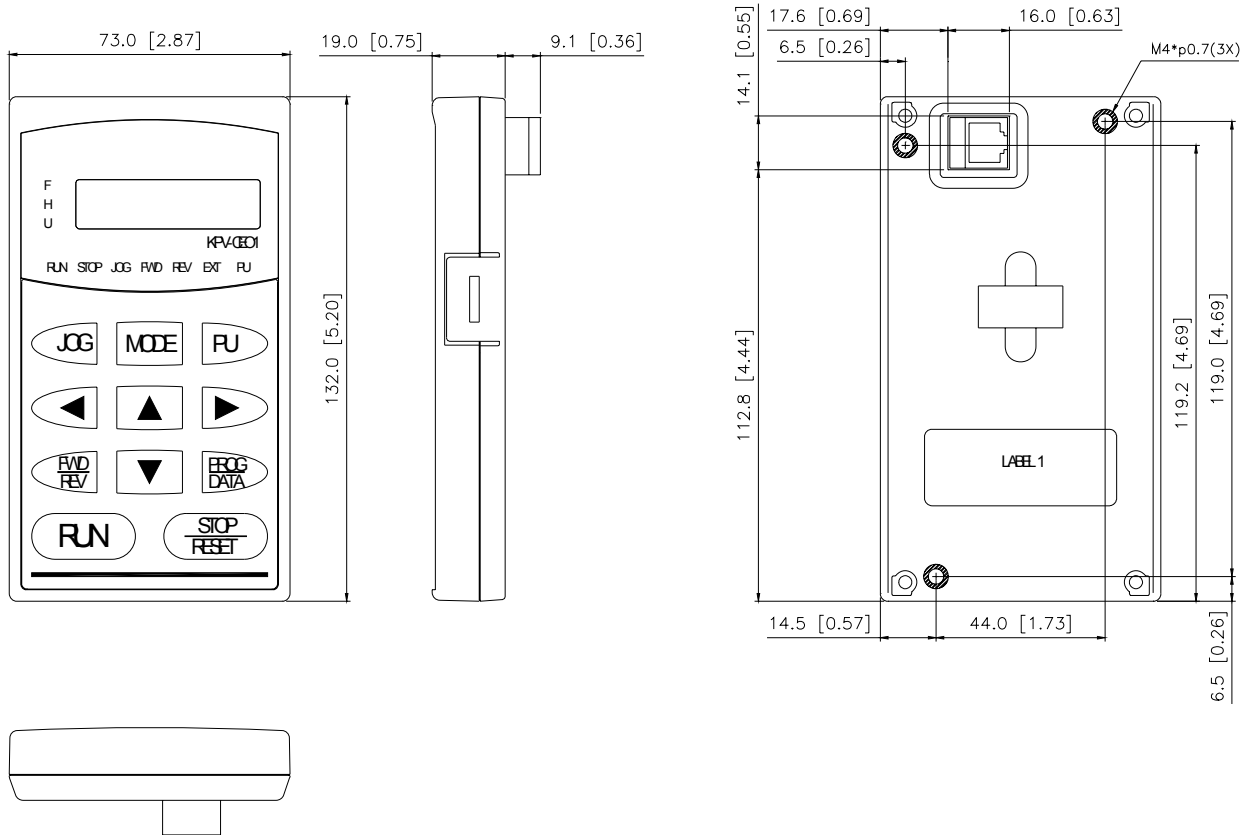

Characters of Digital Keypad Displayed on the LCD

Number	0	1	2	3	4	5	6	7	8	9
LCD	0	1	2	3	4	5	6	7	8	9
Eng. Letter	A	b	Cc	d	E	F.	G	Hh	I	Jj
LCD	A	b	Cc	d	E	F	G	Hh	I	Jj
Eng. Letter	K	L	n	Oo	P	q	r	S	Tt	U
LCD	K	L	n	Oo	P	q	r	S	Tt	U
Eng. Letter	v	Y	Z							
LCD	v	Y	Z							

A-6 Speed Feedback PG Card Selection

EMVJ-PG01R/PG02R

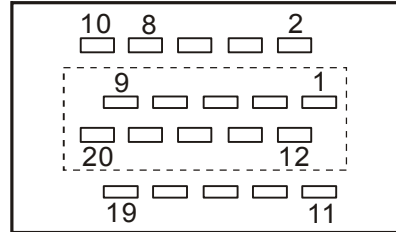
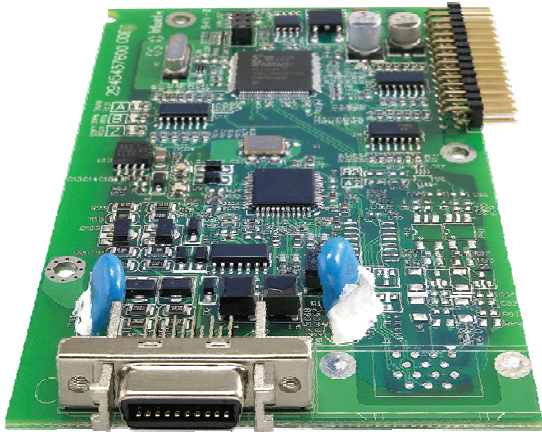

Layout of J1 Drive Connector

Function of J1 Terminal

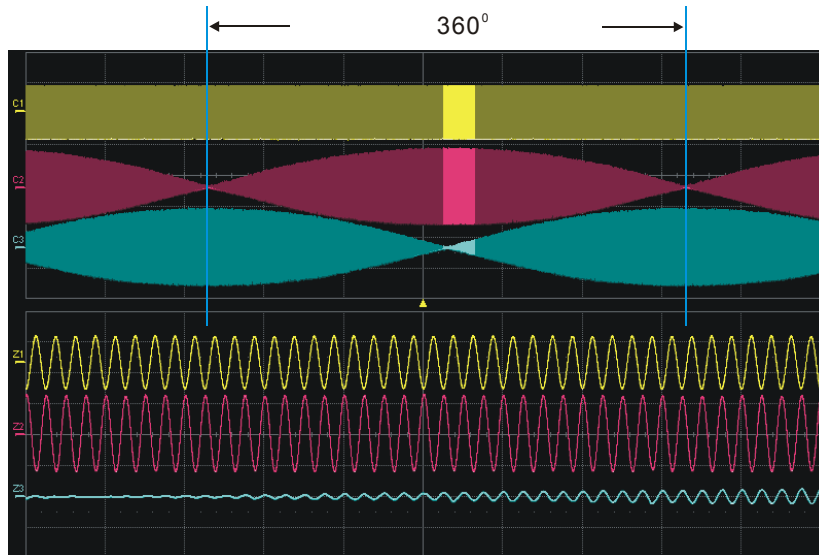
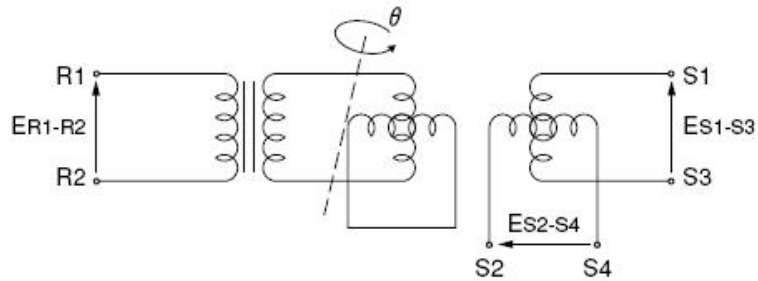

Pictures of (top-down) C1 “E_{R1-R2}”, C2 “E_{S1-S3}”, C3 “E_{S2-S4}”

Pin No	Terminal Mark	Function, Description	Specifications
4	SIN- (S4)	Resolver Signal Output	3.5±0.175Vrms, 10kHz
5	SIN+ (S2)		
7	COS+ (S1)		
9	COS- (S3)	Resolver Power Input	7Vrms, 10kHz
14,16	REF+ (R1)		
13,15	REF- (R2)	Shield	
	Shield		

Wiring Length

Encoder Wiring - Diameter mm ² (AWG)			
Core Size	Number of Cores	Wire Standard	Standard Wire Length
0.13 (AWG26)	10 (4 pairs)	UL2464	3 m (9.84 feet)

NOTE

- 1) For wiring the encoder, please use the shielded twisted-pair cable so as to reduce the interference due to noise.
- 2) The shield net must be firmly connected with the SHIELD terminal .
- 3) During wiring, please follow the corresponding provisions for cable wiring so as to avoid hazards and accidents.

Connector Specifications

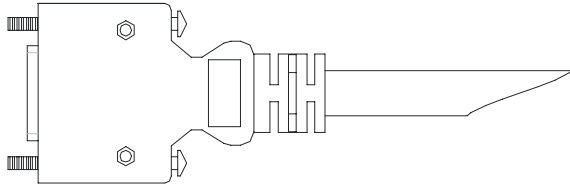

Title	Part No.	Manufacturer
PLUG	3M 10120-3000PE	3M
SHELL	3M 10320-52A0-008	3M

EMVJ-PG01U

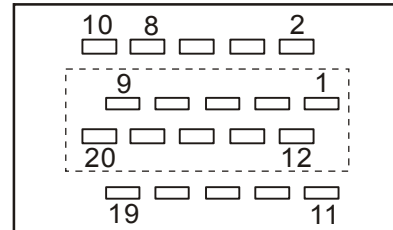
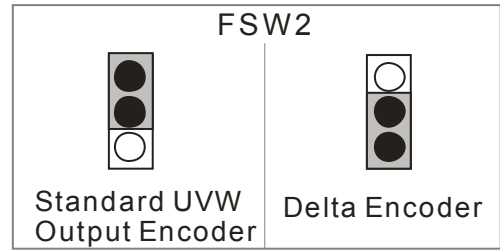
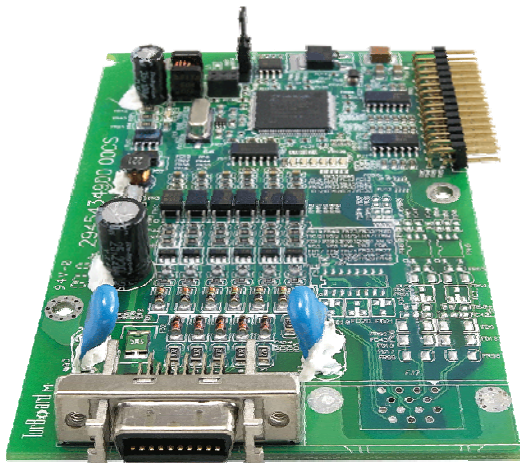

Layout of J1 Drive Connector

Functions of Terminals

Pin No	Terminal Mark	Function, Description	Specifications
4	\bar{A}	Differential incremental signal input of the encoder	Line Driver (Line Driver RS422) Maximum Input Frequency 300kHz
5	A		
7	B		
9	\bar{B}		
10	Z		
2	\bar{Z}		
14, 16	VP	Encoder power output Note: FSW3 can be used to configure the output as +5V or +12V.	Voltage: +5V±0.5V or +12V±1V Current: 200mA max
13, 15	0V	Power common dedicated for the encoder	Reference level for the encoder power
19	U	Differential absolute signal input of the encoder (UVW 3-bit encoding)	Line Driver (Line Driver RS422) Maximum Input Frequency 50kHz
8	\bar{U}		
6	V		
1	\bar{V}		
11	W		
3	\bar{W}		

Wiring Length

Encoder Wiring - Diameter mm ² (AWG)			
Core Size	Number of Cores	Wire Standard	Standard Wire Length
0.13 (AWG26)	10 (4 pairs)	UL2464	3 m (9.84 feet)

NOTE

- 1) For wiring the encoder, please use the shielded twisted-pair cable so as to reduce the interference due to noise.
- 2) The shield net must be firmly connected with the SHIELD terminal .
- 3) During wiring, please follow the corresponding provisions for cable wiring so as to avoid hazards and accidents.

Connector Specifications

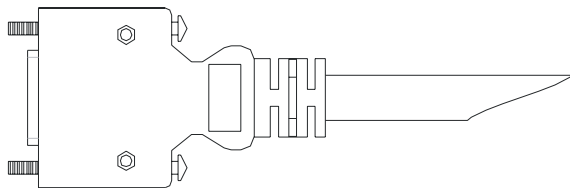

Title	Part No.	Manufacturer
PLUG	3M 10120-3000PE	3M
SHELL	3M 10320-52A0-008	3M

A-7 Communication Card

EMVJ-MF01



Terminal	Description
⊕	Ground terminal
SG-	RS485 terminals
SG-	
GND	Common ground for signals

 **NOTE**

1. For wiring, please use the shielded twisted-pair cable so as to reduce the interference due to noise.
2. The shield net must be firmly connected with the SHIELD terminal .

A-8 EMI Filter

Drive	Applicable Filter Model No.	Reference Website
VFD055VL23A-J VFD075VL23A-J VFD150VL43A-J	KMF336A	http://www.dem-uk.com/roxburgh/products/emc_emi_industrial_filters/ KMF336A Three Phase Industrial Mains Filters - High Performance 36 Amps
VFD055VL23A-J VFD150VL43A-J VFD220VL43A-J	KMF350A	http://www.dem-uk.com/roxburgh/products/emc_emi_industrial_filters/ KMF350 Three Phase Industrial Mains Filters - General Purpose 50 Amps
VFD150VL43A-J VFD300VL43A-J VFD370VL43A-J	KMF370A	http://www.dem-uk.com/roxburgh/products/emc_emi_industrial_filters/ KMF336A Three Phase Industrial Mains Filters - High Performance 70 Amps
VFD185VL23A-J VFD220VL23A-J VFD450VL43A-J	KMF3100A	http://www.dem-uk.com/roxburgh/products/emc_emi_industrial_filters/ KMF3100A Three Phase Industrial Mains Filters - High Performance 100 Amps
VFD300VL23A-J VFD370VL23A-J VFD550VL43A-J VFD750VL43A-J	KMF3150A	http://www.dem-uk.com/roxburgh/products/emc_emi_industrial_filters/ KMF3150A Three Phase Industrial Mains Filters - High Performance 150 Amps
VFD055VL43A-J	KMF318A	http://www.dem-uk.com/roxburgh/products/emc_emi_industrial_filters/ KMF318 Three Phase Industrial Mains Filters - General Purpose 18 Amps
VFD075VL43A-J VFD110VL43A-J	KMF325A	http://www.dem-uk.com/roxburgh/products/emc_emi_industrial_filters/ KMF325A Three Phase Industrial Mains Filters - High Performance 25 Amps

EMI Filter Installation

All electrical equipment, including Hybrid drives, will generate high-frequency/low-frequency noise and will interfere with peripheral equipment by radiation or conduction when in operation. By using an EMI filter with correct installation, much interference can be eliminated. It is recommended to use DELTA EMI filter to have the best interference elimination performance.

We assure that it can comply with following rules when Hybrid drive and EMI filter are installed and wired according to user manual:

- EN61000-6-4
- EN61800-3: 1996
- EN55011 (1991) Class A Group 1 (1st Environment, restricted distribution)

General precaution

1. EMI filter and Hybrid drive should be installed on the same metal plate.
2. Please install Hybrid drive on footprint EMI filter or install EMI filter as close as possible to the Hybrid drive.
3. Please wire as short as possible.
4. Metal plate should be grounded.
5. The cover of EMI filter and Hybrid drive or grounding should be fixed on the metal plate and the contact area should be as large as possible.

Choose suitable motor cable and precautions

Improper installation and choice of motor cable will affect the performance of EMI filter. Be sure to observe the following precautions when selecting motor cable.

1. Use the cable with shielding (double shielding is the best).
2. The shielding on both ends of the motor cable should be grounded with the minimum length and maximum contact area.
3. Remove any paint on metal saddle for good ground contact with the plate and shielding.

Remove any paint on metal saddle for good ground contact with the plate and shielding.

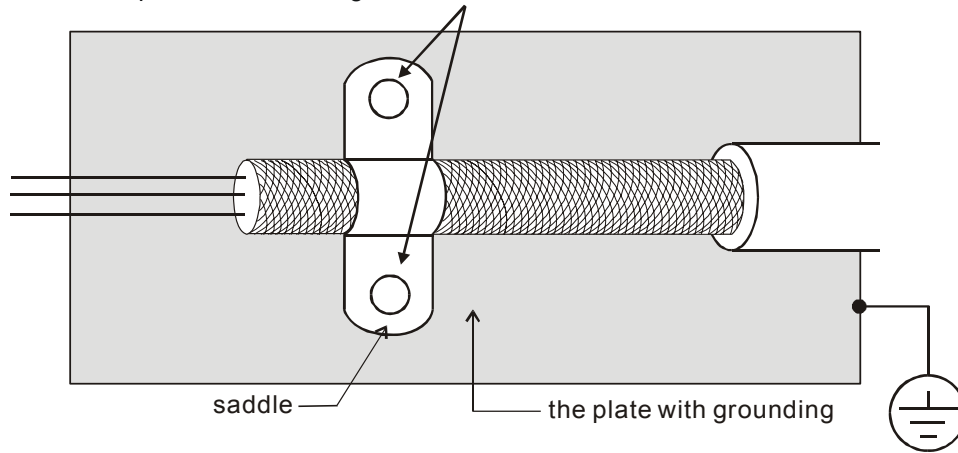

Figure 1

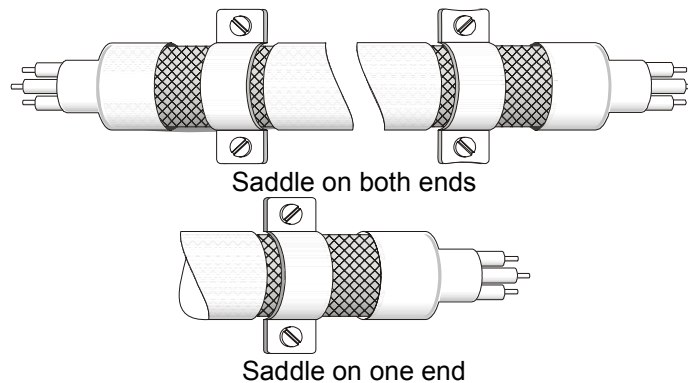

Figure 2

The length of motor cable

When motor is driven by an Hybrid drive of PWM type, the motor terminals will experience surge voltages easily due to components conversion of Hybrid drive and cable capacitance. When the motor cable is very long (especially for the 460V series), surge voltages may reduce insulation quality. To prevent this situation, please follow the rules below:

- Use a motor with enhanced insulation.
- Connect an output reactor (optional) to the output terminals of the Hybrid drive
- The length of the cable between Hybrid drive and motor should be as short as possible (10 to 20 m or less)
- For models 7.5hp and above:

Insulation level of motor	1000V	1300V	1600V
460VAC input voltage	66 ft (20m)	328 ft (100m)	1312 ft (400m)

230VAC input voltage	1312 ft (400m)	1312 ft (400m)	1312 ft (400m)
----------------------	----------------	----------------	----------------

- For models 5hp and less:

Insulation level of motor	1000V	1300V	1600V
460VAC input voltage	66 ft (20m)	165 ft (50m)	165 ft (50m)
230VAC input voltage	328 ft (100m)	328 ft (100m)	328 ft (100m)

 **NOTE**

Never connect phase lead capacitors or surge absorbers to the output terminals of the Hybrid drive.

- If the length is too long, the stray capacitance between cables will increase and may cause leakage current. It will activate the protection of over current, increase leakage current or not insure the correction of current display. The worst case is that Hybrid drive may damage.
- If more than one motor is connected to the Hybrid drive, the total wiring length is the sum of the wiring length from Hybrid drive to each motor.
- For the 460V series Hybrid drive, when an overload relay is installed between the drive and the motor to protect motor over heating, the connecting cable must be shorter than 50m. However, an overload relay malfunction may still occur. To prevent the malfunction, install an output reactor (optional) to the drive or lower the carrier frequency setting (Pr.00-17).

 **NOTE**

When a thermal O/L relay protected by motor is used between Hybrid drive and motor, it may malfunction (especially for 460V series), even if the length of motor cable is only 165 ft (50m) or less. To prevent it, please use AC reactor and/or lower the carrier frequency (Pr. 00-17 PWM carrier frequency).