

FUJI ELECTRIC INSTRUCTION MANUAL

Single-phase 200V input **FVR-E11S-7EN**

Three-phase 400V input **FVR-E11S-4EN**

Low noise high performance inverter



Caution

Thank you for purchasing our FVR-E11S series inverter.



- This product is designed to drive a three-phase induction motor. Read through this instruction manual and be familiar with the handling method for correct use.
- Improper handling blocks correct operation or causes a short life or failure.
- Have this manual delivered to the final user of the product. Keep this manual in a safe place until the inverter is discarded.
- For the usage of optional equipment, refer to the manuals for optional equipment.

Introduction

Safety precautions

Read through this manual before starting installation, connection (wiring), operation, or maintenance and inspection for correct use. Be familiar with the knowledge about the device, information about safety, and all the precautions before starting operation.

The safety precautions are classified into the following categories in this manual.

 WARNING	Negligence of the description can cause dangers including deaths or serious injuries.
 CAUTION	Negligence of the description can cause dangers including intermediate or slight injuries or material losses.

Negligence of the description under the CAUTION title can cause serious results in certain circumstances. These safety precautions are important and must be observed at any time.

Purposes

WARNING

- FVR-E11S is designed to drive a three-phase induction motor. Do not use it for single-phase motors or for other purposes.
Otherwise fire could occur.
- FVR-E11S may not be used for a life-support system or other purposes directly related to the human safety.
- Though FVR-E11S is manufactured under strict quality control, install safety devices for applications where serious accidents or material losses are foreseen in relation to the failure of it.
Otherwise an accident could occur.

Installation

WARNING

- Install the inverter on a nonflammable material such as metal.
Otherwise fire could occur.
- Do not place flammable matter nearby.
Otherwise fire could occur.

CAUTION

- Do not hold the cover during transportation.
Otherwise the inverter may drop and cause injuries.
- Do not allow lint, paper, wood chips, dust, metallic chips or other foreign matter in the inverter or do not allow them attached to the heat sink.
Otherwise fire or an accident could occur.
- Do not install or operate an inverter which is damaged or lacking parts.
Otherwise fire, an accident or injuries could occur.

Wiring

WARNING

- When connecting the inverter to the power supply, add a circuit breaker for circuit protection and earth leakage breaker in the path of power supply.
Otherwise fire could occur.
- Be sure to connect the grounding cable without fail.
Otherwise electric shock or fire could occur.
- Both screws of grounding terminals of FVR5.5/7.5E11S-4EN has to be tightened up securely even if one grounding terminal is not used.
Otherwise electric shock or fire could occur.
- Qualified electricians should carry out wiring.
Otherwise electric shock could occur.
- Perform wiring after checking that the power supply is turned off.
Otherwise electric shock could occur.
- Be sure to perform wiring after installing the main body of the inverter.
Otherwise electric shock or injuries could occur.

 **CAUTION**

- Check that the number of phases and the rated voltage of the product agree with the number of phases and the voltage of the AC power supply.
Otherwise fire or an accident could occur.
- Do not connect the AC power cables to the output terminals (U, V, W).
Otherwise fire or an accident could occur.
- Do not connect a braking resistor directly to the DC terminals (P (+), N (-)).
Otherwise fire or an accident could occur.
- The inverter, motor and wiring generate electric noise. Take care of malfunction of the nearby sensors and devices.
Otherwise an accident could occur.

Operation

 **WARNING**

- Be sure to install the terminal cover before turning the power on. Do not remove the cover during power application.
Otherwise electric shock could occur.
- Do not operate switches with wet hands.
Otherwise electric shock could occur.
- If the retry function has been selected, the inverter may automatically restart according to some causes after tripping.
(Design the machine so that human safety is ensured after restarting.)
Otherwise an accident could occur.
- If the torque limit function has been selected, the inverter may operate at an acceleration/deceleration time or speed different from the set ones. Design the machine so that safety is ensured even in such cases.
Otherwise an accident could occur.
- The STOP key is only effective when function setting has been established to make the STOP key enable. Prepare an emergency stop switch separately.
Otherwise an accident could occur.
- If an alarm reset is made with the operation signal turned on, a sudden start will occur. Check that the operation signal is turned off in advance.
Otherwise an accident could occur.
- Do not touch the inverter terminals during power applies to the inverter even if the inverter stops.
Otherwise electric shock could occur.

 **CAUTION**

- Do not turn the main circuit power on or off to start or stop inverter operation.
Otherwise failure could occur.
- Do not touch the heat sink and braking resistor because they become very hot.
Otherwise burns could occur.
- Setting the inverter to high speeds is easy. Check the performance of the motor and machines before changing the setting.
Otherwise injuries could occur.
- The brake function of the inverter does not provide mechanical holding means.
Injuries could occur.

Maintenance and inspection and parts replacement

WARNING

- Turn the power off and wait for at least five minutes before starting inspection.
(Further, check that the charge lamp is unlit, and check the DC voltage across the P (+) and N (-) terminals to be lower than 25Vdc.)
Otherwise electric shock could occur.
- Maintenance and inspection and parts replacement should be made only by qualified persons.
(Take off the watch, rings and other metallic matter before starting work.)
(Use insulated tools.)
Otherwise electric shock or injuries could occur.

Disposal

CAUTION

- Handle the inverter as an industrial waste when disposing of it.
Otherwise injuries could occur.

Others

WARNING

- Never remodel.
Otherwise electric shock or injuries could occur.

GENERAL PRECAUTIONS

Drawings in this manual may be illustrated without covers or safety shields for explanation of detail parts. Restore the covers and shields in the original state and observe the description in the manual before starting operation.

Conformity to Low Voltage Directive in EU

[Available only for the products with CE or TÜV mark]

CAUTION

1. Safe separation for control interface of this inverter is provided when this inverter is installed in overvoltage category II. PELV(Protective Extra Low Voltage) circuit or SELV(Safety Extra Low Voltage) circuit from external controller is connected to the interface directly.
2. Basic insulation for control interface of this inverter is provided when this inverter is installed in overvoltage category III. An insulation transformer has to be installed between power supply mains and this inverter when SELV circuit from external controller is connected to this inverter directly. Otherwise supplementary insulation between control interface of this inverter and environment must be provided.
3. The ground terminal G should always be connected to the ground. Don't use only RCD as the sole method of electric shock protection.
Dimensions of external PE conductor should be same as dimensions of input phase conductor and capable for possible fault.
4. Use MCCB or MC that conforms to EN or IEC standard.
5. Where RCD (Residual-current-operated protective device) is used for protection in case of direct or indirect contact, only **RCD of type B** is allowed on the supply side of this EE (Electric equipment). Otherwise another protective measure shall be applied such as separation of the EE from the environment by double or reinforced insulation or isolation of EE and supply system by the transformer.
6. The inverter has to be installed in environment of pollution degree 2. If the environment is pollution degree 3 or 4, the inverter has to be installed in a cabinet of IP54 or higher.
7. Use a prescribed wire according to the EN60204 Appendix C.
8. Install the inverter, AC or DC reactor, input or output filter in an enclosure that meets the following requirement, to prevent a human body from touching directly to these equipment.
 - 1) When a person can touch easily on each connecting terminal or live parts, install the inverter, AC or DC reactor, output filter in an enclosure with minimum degree of protection of IP4X.
 - 2) When a person can not touch easily on each connecting terminal or live parts, install the inverter, AC or DC reactor, output filter in an enclosure with a minimum degree of protection of IP2X.
9. It is necessary to install the inverter in appropriate method using an appropriate RFI filter to conform to the EMC directive. It is customer's responsibility to check whether the equipment ,the inverter is installed in, conforms to EMC directive.
10. Do not connect copper wire to grounding terminal directly. Use cramp terminal with tin or equivalent plating to reduce electrochemical potential.
11. Do not remove the keypad panel before disconnecting power and do not insert/remove the extension cable for keypad panel remote operation while power is on. Confirm that the extension cable is securely latched to keypad panel and inverter before power is on.
A supplementary isolation is required for the extension cable when the inverter is installed in overvoltage category III.
12. Basic insulation for control interface of this inverter is provided when the inverter is used at altitude over 2000m. The use at altitude over 3000m is not permitted.
13. The supply mains neutral has to be earthed for FVR-E11S-4EN.

Caution for UL/cUL requirement [Available only for the products with UL/cUL mark]

⚠ CAUTION

1. [WARNING] Take care of electric shock. Be sure to turn the inverter off before starting work.
2. [CAUTION] When the charge lamp is lit, the inverter is still charged at a dangerous voltage.
3. [WARNING] There are two or more live parts inside the inverter.
4. The inverter is approved as a part used inside a panel. Install it inside a panel.
5. Perform wiring to the input, output and control terminals of the inverter, referring to the table below. Use UL certified round crimp terminal to the input and output terminals with insulation cover or covered with reduced tube to obtain the insulation distance. Use a crimping tool recommended by the terminal manufacturer when fabricating crimp terminals.
6. Install a fuse or circuit breaker between the power supply and the inverter, referring to the table below.

Inverter type	Tightening torque [N·m]		Applicable wire diameter [AWG] (mm ²) ¹⁾		Fuse ²⁾ [A]	Breaker [A]
	L1/R,L2/S, L3/T L1/L, L2/N P1,P(+) DB,N(-) U, V, W	Control section	L1/R,L2/S, L3/T L1/L, L2/N ⊕G P1,P(+) DB,N(-) U, V, W	Control section		
FVR0.1E11S-7EN	1.2	0.4	14 (2.1)	20 (0.5)	6	5
FVR0.2E11S-7EN					6	5
FVR0.4E11S-7EN					10	10
FVR0.75E11S-7EN					15	15
FVR1.5E11S-7EN	1.8	0.4	12 (3.3)	20 (0.5)	30	30
FVR2.2E11S-7EN					10 (5.3)	40
FVR0.4E11S-4EN	1.8	0.4	14 (2.1)	20 (0.5)	6	5
FVR0.75E11S-4EN					10	10
FVR1.5E11S-4EN					15	15
FVR2.2E11S-4EN					20	20
FVR4.0E11S-4EN	3.5	0.4	12 (3.3)	20 (0.5)	30	30
FVR5.5E11S-4EN			10 (5.3)		40	40
FVR7.5E11S-4EN						

1) Use copper wires of allowable maximum temperature 60 or 75 degree C.

2) Use UL certified AC600V "Class J fuse."

7. The inverters FVR0.1 to 2.2E11S-7 are suitable for use on a circuit capable or delivering not more than 20,000 rms symmetrical amperes, 240V maximum.
8. The inverters FVR0.4 to 7.5E11S-4 are suitable for use on a circuit capable or delivering not more than the following symmetrical amperes, 480V maximum.
When the fuse is installed : 20,000A
When the circuit breaker is installed : 5000A
9. FVR-E11S-EN is an open type inverter.
10. A class 2 circuit wired with class 1 wire.

1. Before Using the Inverter	1-1	7. Troubleshooting	7-1
1-1 Receiving Inspection	1-1	7-1 When Protective Function Goes	
1-2 Appearance of Product	1-1	Active	7-1
1-3 Handling the Product	1-3	7-2 When Motor rotates Incorrectly	7-5
1-4 Transportation	1-6	8. Maintenance and Inspection	8-1
1-5 Storage	1-6	8-1 Daily Inspection	8-1
2. Installation and Connection	2-1	8-2 Periodic Inspection	8-1
2-1 Operating Environment	2-1	8-3 Measurement of Electrical Amounts	
2-2 Installation Method	2-1	in Main Circuit	8-4
2-3 Connection	2-2	8-4 Insulation Test	8-5
2-3-1 Basic Connection	2-2	8-5 Replacement Parts	8-5
2-3-2 Connection of Main Circuit and		8-6 Inquiries about Product and	
Grounding Terminal	2-4	Guarantee	8-5
2-3-3 Connection of Control Terminal	2-6	9. Specifications	9-1
2-3-4 Terminal Layout	2-9	9-1 Standard Specifications	9-1
2-3-5 Applicable Devices and		9-2 Common Specifications	9-3
Cable Sizes for Main Circuit	2-11	9-3 External Dimensions	9-7
3. Operation	3-1	9-4 RS485 Communication	9-11
3-1 Inspection and Preparation		9-4-1 Connector and Communication	
Before Operation	3-1	Cable	9-12
3-2 Operation Method	3-1	9-4-2 Recommended RS-232C/RS485	
3-3 Test Operation	3-1	Converter	9-12
4. Keypad Panel	4-1	9-4-3 Remove/local changeover	9-12
4-1 Appearance of Keypad Panel	4-1	9-4-4 Communication Protocol	9-13
4-1-1 Upon an Alarm	4-3	9-4-5 Standard Frame	9-15
4-1-2 Digital Frequency Setting Method	4-3	9-4-6 Short Frame	9-16
5. Selecting Functions	5-1	9-4-7 Details of Frame	9-17
5-1 Function Selection List	5-1	9-4-8 Broadcasting	9-18
5-2 Detail Description of Each Function	5-11	9-4-9 Communication Error Code	9-19
Fundamental Functions (F Functions)	5-11	9-4-10 Data Type	9-19
Extension Terminal Functions (E Functions)		9-4-11 Function Code List	9-20
.....	5-21	9-4-12 Data Format	9-24
Control Functions of Frequency		10. Options	10-1
(C Functions)	5-26	10-1 External Options	10-1
Motor Parameters (P Functions)	5-29	11. Applicable Reactor	11-1
High Performance Functions (H Functions)	5-31	12. Electromagnetic compatibility	12-1
Alternative Motor Parameters (A Functions)		12-1 General	12-1
.....	5-39	12-2 Recommended Installation Instructions	
Optional Functions(O Functions)	5-40	12-1
6. Protective Operation	6-1		
6-1 List of Protective Operations	6-1		
6-2 Alarm Reset	6-2		

1. Before Using the Inverter

1-1 Receiving Inspection

Unpack and check the following items.

If you have any problems with the product, contact the dealer or the nearest branch of Fuji Electric Co., Ltd.

- (1) Check the ratings nameplate to confirm that the delivered product is the ordered one.

TYPE: Type of inverter

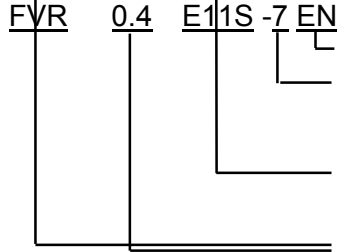

Version

Power voltage system:

7: Single-phase 200V class

4: Three-phase 400V class

Series name: E11S

Nominal applicable motor capacity: 0.4: 0.4 kW

Product type

FUJI ELECTRIC	
TYPE	FVR0.4E11S-7EN
SOURCE	1PH 200-240V 50/60Hz 6.4A
OUTPUT	3PH 0.4kW 200-230V 0.2-400Hz 3.0A 150% 1min
SER.No.	010113R0001
Fuji Electric Co.,Ltd. Made in Japan	

SOURCE: Number of input phases, input voltage, input frequency, input current

OUTPUT: Number of output phases, rated output capacity, rated output voltage, output frequency range, rated output current, overload current rating

SER. NO.: Product number

0 1 0113R0001

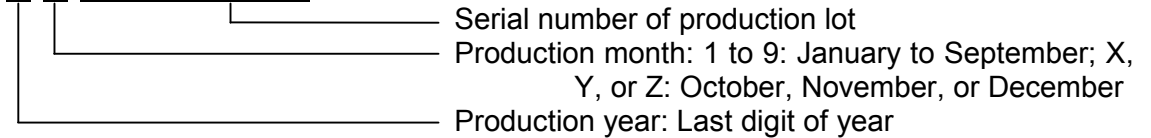

- (2) Check for breakage, missing parts, and dents or other damage on the cover and the main body given during transportation.
- (3) Instruction manual for inverter body is built-in.

1-2 External view of Product

- (1-1) Overall view (4.0kW or below)

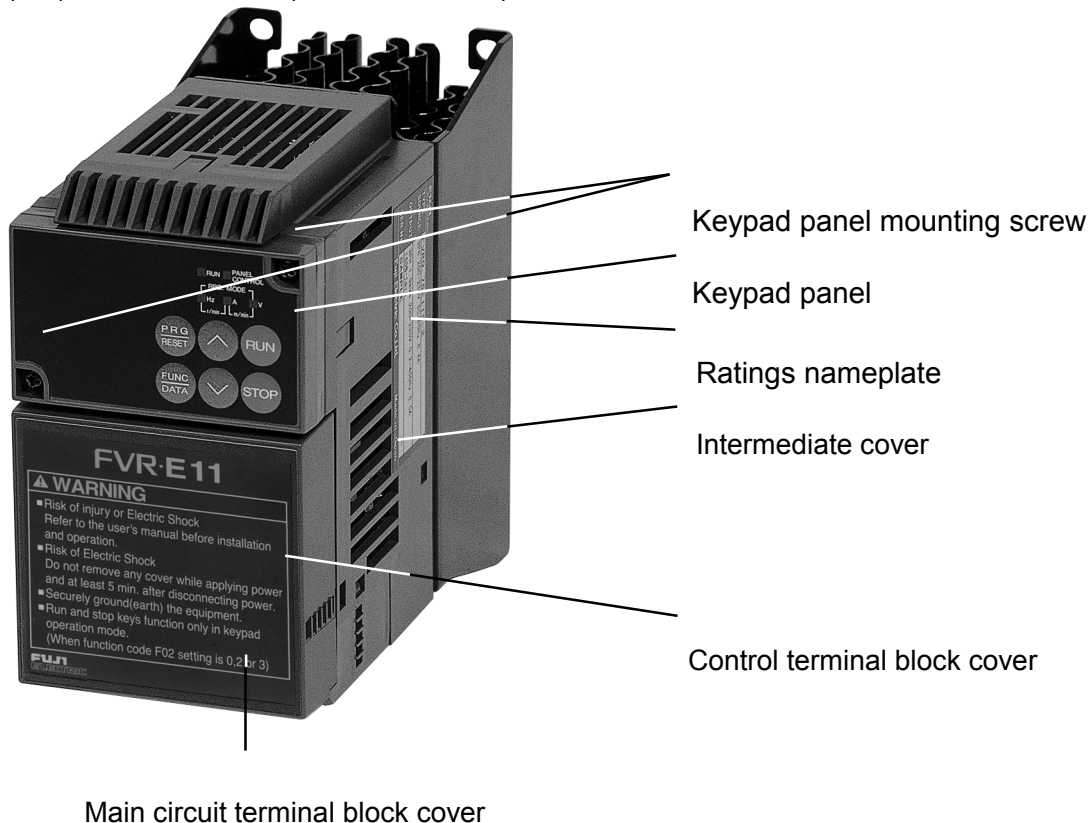

(1-2) Overall view (5.5,7.5kW)

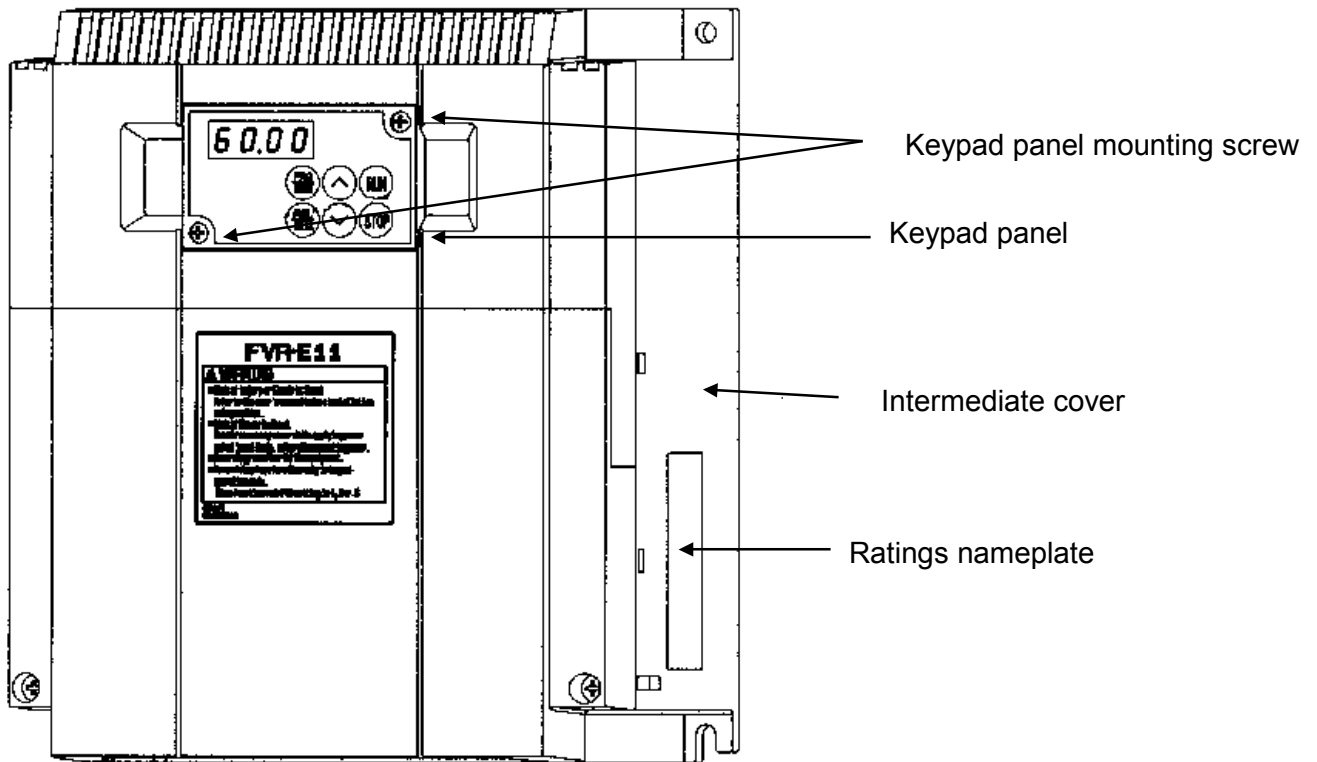

(2-1) View of wiring part(4.0kW or below) Terminal block cover

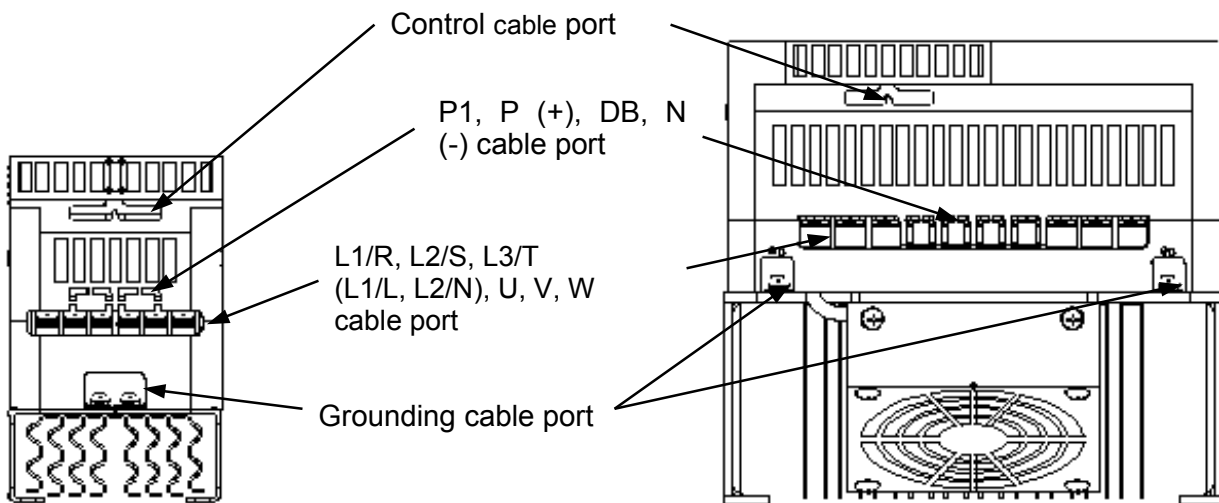

A barrier is provided in the main circuit terminal block cover for the P1, P (+), DB and N (-) cable port. Cut the barrier using nippers or the like before wiring.

(2-2) View of wiring part(5.5,7.5kW)

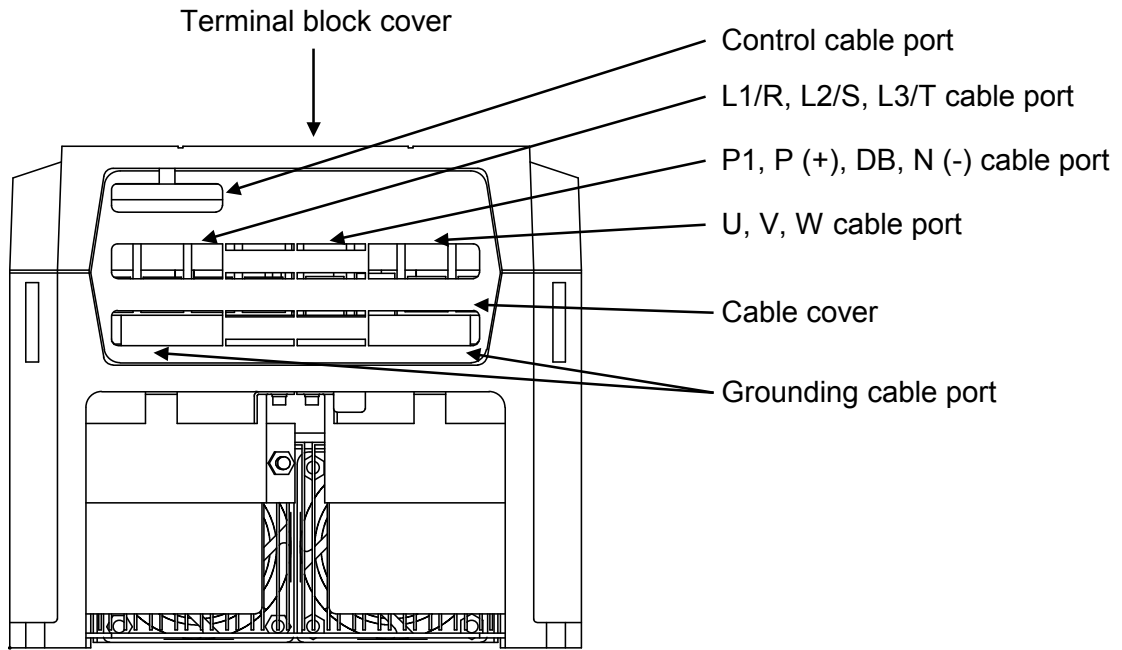

A barrier is provided in the cable cover for the P1, P (+), DB and N (-) cable port. Cut the barrier using nippers or the like before wiring.

1-3 Handling the Product

(1) Removing the control terminal block cover(4.0kW or below)

While lightly pushing the sides of the control terminal block cover at the catches, lift the cover in the procedure shown in Fig. 1-3-1 to remove it.

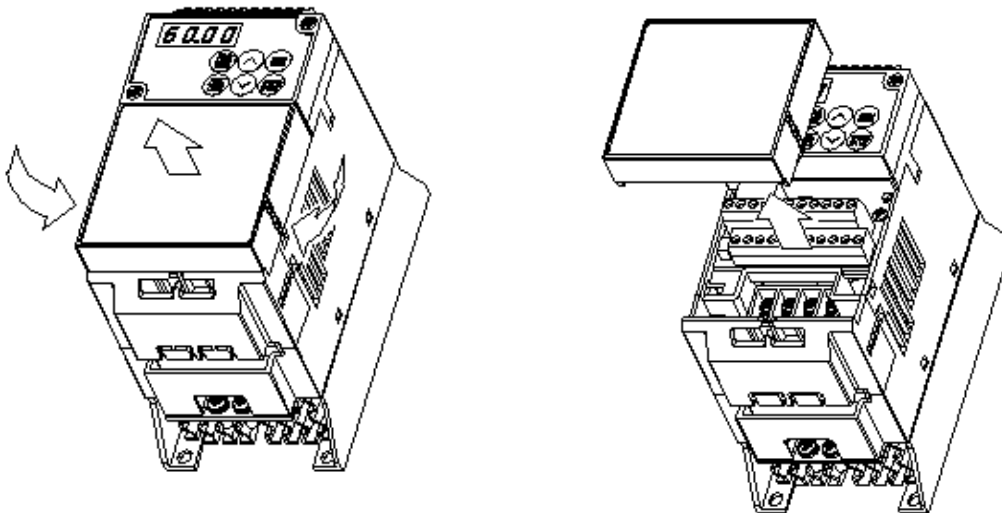

Fig. 1-3-1 Removing the control terminal block cover

(2) Removing the main circuit terminal block cover(4.0kW or below)

While lightly pushing the sides of the main circuit terminal block cover at the catches, slide toward you in the procedure shown in Fig. 1-3-2 to remove it.

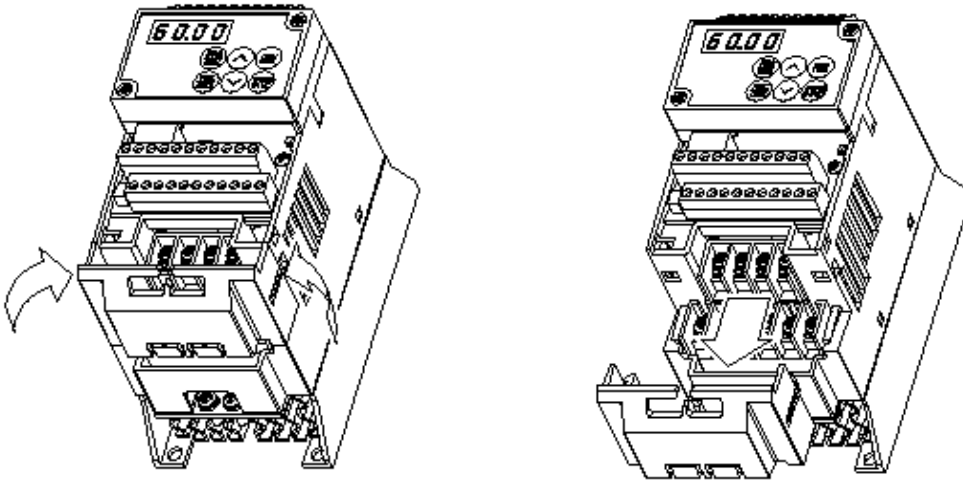

Fig. 1-3-2 Removing the main circuit terminal block cover

(3) Removing the terminal block cover(5.5,7.5kW)

Loose the screws indicated below and while lightly pushing the sides of the terminal block cover at the catches, lift the cover in the procedure shown in Fig. 1-3-3 to remove it.

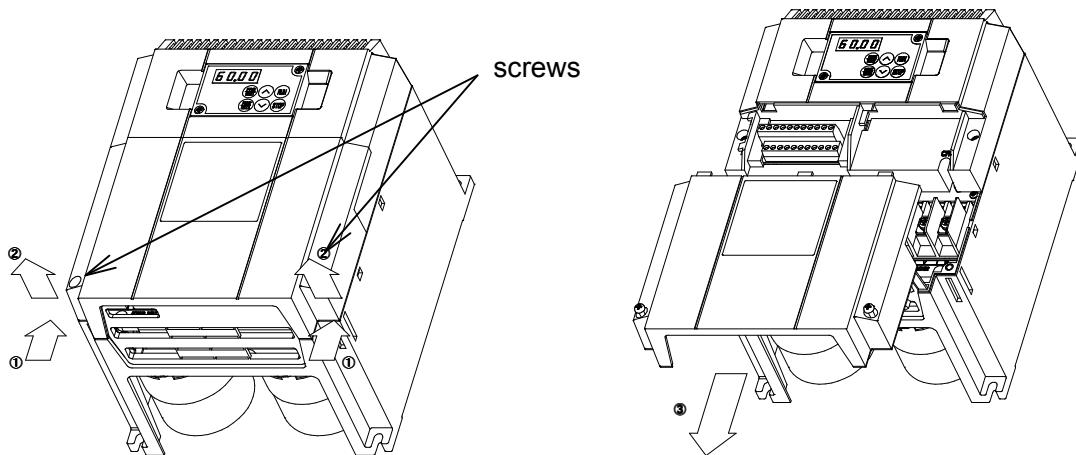

Fig. 1-3-3 Removing the terminal block cover

(4) Removing the keypad panel

Loosen the keypad panel mounting screws and remove the keypad panel in the procedure shown in Fig. 1-3-4. During the procedure, slowly remove the keypad panel right toward the top. If the keypad panel is handled abruptly, the connector will be broken.

Mounting screw (M3)

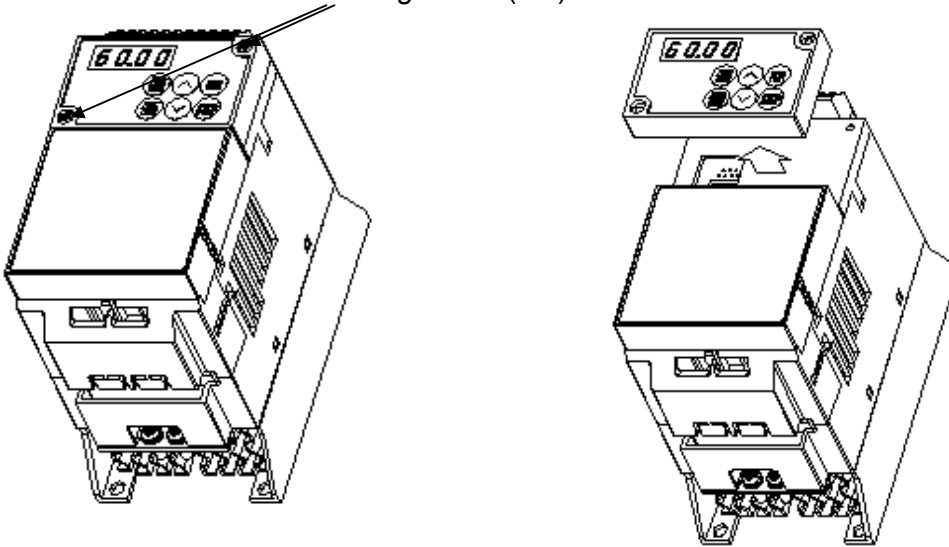

Fig. 1-3-4 Removing the keypad panel

Reverse the procedures to mount the terminal block cover and keypad panel.

1-4 Transportation

Always hold the main unit when carrying the inverter.

If covers or parts are held, the inverter may be broken or it may drop.

1-5 Storage

To store temporarily

Store the inverter in an environment described in Table 1-5-1.

Table 1-5-1 Storage environment

Item	Specifications	
Ambient temperature	-10~+50 degree C	Places not subjected to abrupt temperature changes or condensation or freezing
Storage temperature ^(Note 1)	-25~+65 degree C	
Relative humidity	5~95% ^{Note 2}	
Atmosphere	The product must not be exposed to dust, direct sunlight, corrosive or flammable gases, oil mist, vapor, water drops or vibration. There must be little salt in the atmosphere.	
Atmospheric pressure	86~106kPa (During storage)	
	70~106kPa (During transportation)	

Note 1: The storage temperature is for a short time during transportation or the like.

Note 2: Even if the humidity is within the requirements of the specifications, places with abrupt temperature changes are subject to condensation or freezing. Avoid storing the inverter in such places.

- (1) Do not place the inverter directly on the floor.
- (2) If the ambient atmosphere is adverse, wrap the inverter in a vinyl sheet or the like when storing.
- (3) If humidity may give an ill effect, add a drying agent (such as silica gel) in the package prepared as described in item (2).

To store for a long time

The long-term storage method of the inverter varies largely according to the environment of the storage site. General storage methods are described below.

- (1) The storage site must satisfy the requirements of specifications for temporary storage. However, for storage exceeding three months, the upper limit of the ambient temperature shall not exceed 30 °C. This is for the prevention of deterioration of electrolytic capacitors left turned off.
- (2) The package must be air tight so that moisture will not enter. Add a drying agent inside the package to contain the relative humidity inside the package within 70%.
- (3) The inverter installed on a unit or control panel and left is likely to be exposed to moisture and dust. If this is the case, remove the inverter and move it to a preferable environment.
- (4) Electrolytic capacitors left turned off for an extended period of time deteriorate. Do not store for one year or more without turning the power on.

2. Installation and Connection

2-1 Operating Environment

Install the inverter in an environment described in Table 2-1-1.

Table 2-1-1 Operating environment

Item	Specifications
Site	Indoors
Ambient temperature	-10 to +50 degree C
Relative humidity	5 to 95% (without condensation)
Atmosphere	The inverter must not be exposed to dust, direct sunlight, corrosive gases, oil mist, vapor or water drops. There must be little salt. No condensation occurs due to abrupt temperature changes.
Altitude	1,000 m max. (Refer to Table 2-1-2 for altitudes exceeding 1000 m.)
Atmospheric pressure	86 to 106 kPa
Vibration	3mm 2 to 9 Hz 9.8m/s ² 9 to 20 Hz 2m/s ² 20 to 55 Hz 1m/s ² 55 to 200 Hz

Table 2-1-2 Output attenuation ratio in relation to altitude

Altitude	Output current attenuation ratio
1000 m or less	1.00
1000-1500m	0.97
1500-2000m	0.95
2000-2500m	0.91
2500-3000m	0.88

2-2 Installation Method

- (1) Tightly mount the inverter in the upright position on a rigid structure so that the "FVR-E11" characters face front. Avoid mounting the inverter upside down or avoid mounting horizontally.
- (2) Allow clearances for cooling wind shown in Fig. 2-2-1 to cool down the inverter which generates heat during operation. The generated heat is radiated upward. Do not install the inverter below a heat sensitive device.
- (3) The temperature of the heat sink rises to about 90 degrees C during operation of the inverter. Mount the inverter on a base made of a material withstanding the temperature rise.

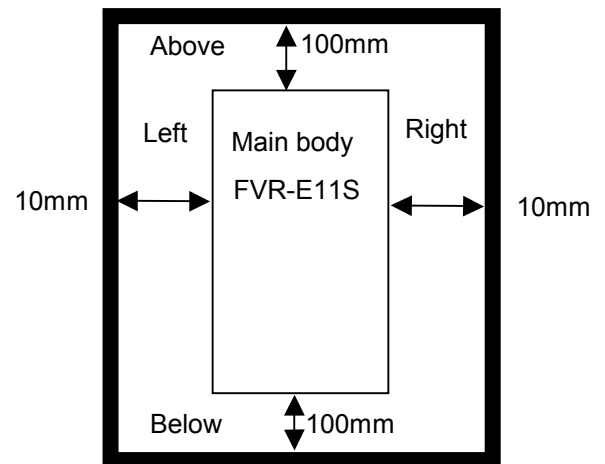



Fig. 2-2-1

 WARNING	Install the inverter on a nonflammable material such as metal. Otherwise fire could occur.
--	--

- (4) When installing the inverter inside a control panel or the like, take full consideration for ventilation so that the ambient temperature of the inverter does not exceed the specification requirements. Do not install the inverter in a poorly ventilated small enclosure.
- (5) When storing multiple inverters inside a single unit or inside a control panel, horizontal installation is recommended to reduce mutual temperature effects. When a vertical layout is adopted for an unavoidable reason, install a partition plate or the like between inverters to isolate the heat of the lower inverter.

 CAUTION	Do not allow lint, paper, wood chips, dust, metallic chips or other foreign matter in the inverter or do not allow them attached to the heat sink. Otherwise fire or an accident could occur.
--	---

2-3 Connection

Remove the control terminal block cover to connect the control terminal block. Remove the main circuit terminal block cover to connect the main circuit terminal block. Correctly connect cables taking care of the following precautions.

2-3-1 Basic Connection

- (1) Be sure to connect the power cables to main circuit power terminals L1/R, L2/S and L3/T or L1/L, L2/N of the inverter. If the power cables are connected to other terminals, the inverter will be broken. As well, check the source voltage for the allowable voltage range specified on the nameplate and so on.
- (2) Connect the grounding terminal without fail according to national or local electric code to prevent electric shock, fire or other disasters and to reduce electric noise.
- (3) Use reliable crimp terminals for connection of cables to the terminals.
- (4) After finishing wiring, check the following.
 - a. Check if the cables are connected correctly.
 - b. Check if there is no failure of connection.
 - c. Check if terminals or cables are short circuited or there is a ground fault.
- (5) To change connection of an inverter having been turned on
The smoothing capacitor in the direct current part of the main circuit takes time to be discharged after it is turned off. To avoid danger, check the DC voltage (across main circuit terminals P (+) and N (-)) for a safety voltage (25 Vdc or lower) using a multi-meter, after the charge lamp is unlit. Wait until the residual voltage is discharged before shorting a circuit, to avoid being hit by sparks caused by the voltage (electric charge).

 WARNING	<ul style="list-style-type: none">• Be sure to connect the grounding cable without fail. Otherwise electric shock or fire could occur.• Qualified electricians should carry out wiring. Otherwise electric shock could occur.• Perform wiring after checking that the power supply is turned off. Otherwise electric shock could occur.
--	--

Basic connection diagram

Electric cabinet

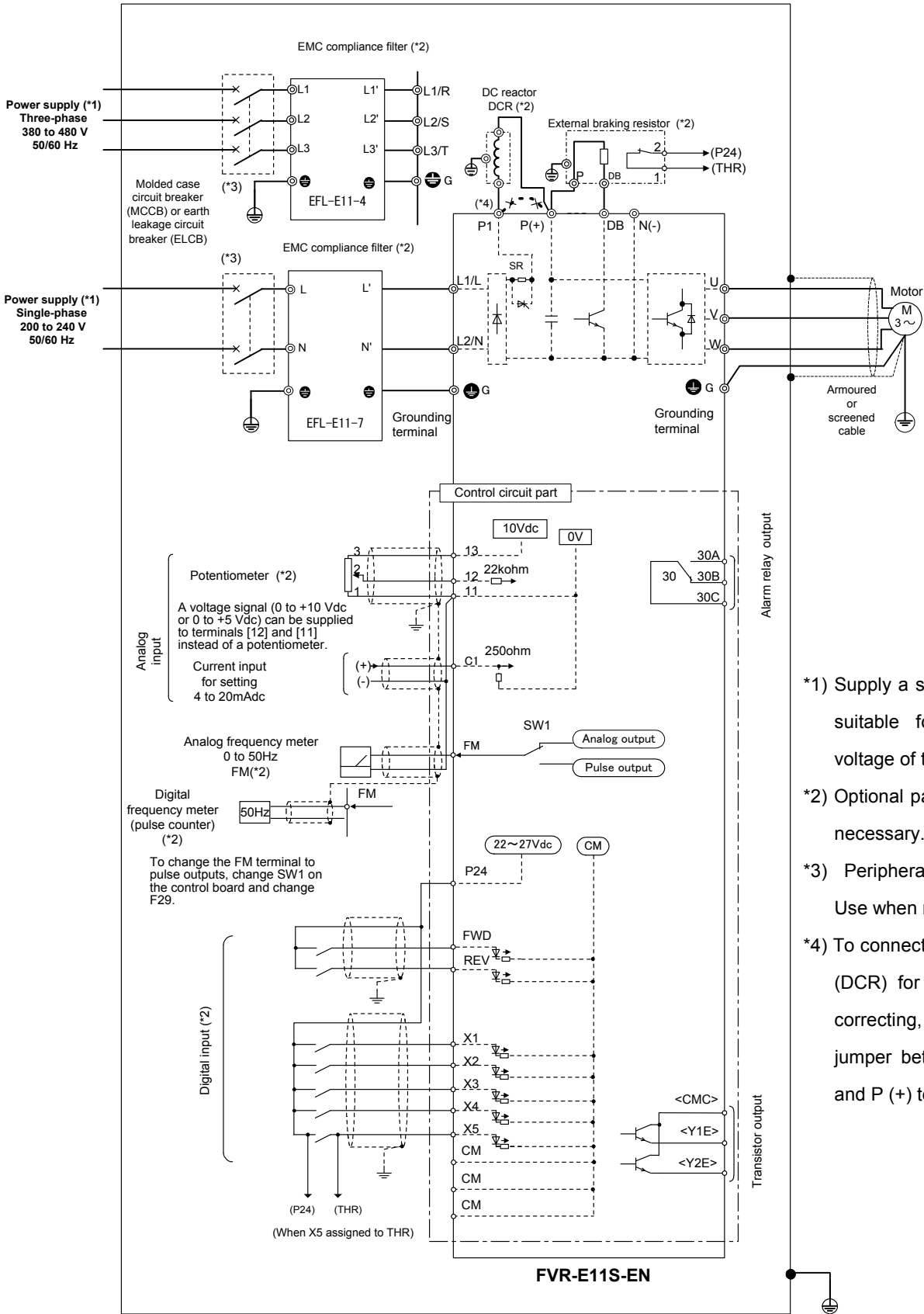

- *1) Supply a source voltage suitable for the rated voltage of the inverter.
- *2) Optional part. Use when necessary.
- *3) Peripheral equipment. Use when necessary.
- *4) To connect a DC reactor (DCR) for power factor correcting, remove the jumper between the P1 and P (+) terminals.

2-3-2 Connection of Main Circuit and Grounding Terminal

Table2-3-1 Connection of Main Circuit and Grounding Terminal

Symbol	Name of terminal	Description
L1/R,L2/S,L3/T	Main circuit power input	Connects a 3-phase power supply.
L1/L,L2/N	Main circuit power input	Connects a 1-phase power supply.
U,V,W	Inverter output	Connects a 3-phase induction motor.
P1,P(+)	For DC reactor	Connects an optional DC reactor.
P(+),DB	For external braking resistor	Connects an optional external braking resistor.
P(+),N(-)	DC link circuit terminal	Connected to DC link circuit.
 G	grounding	Grounding terminal of the inverter chassis (housing). Connect to the protective ground.

- (1) Main circuit power input terminal (L1/R, L2/S, L3/T,L1/L,L2/N)
 - a. Connect the main circuit power input terminals to the power supply through a circuit breaker for circuit (wiring) protection or an earth leakage breaker. There is not need to match the phase sequence.
 - b. It is recommended to connect a magnetic contactor to disconnect the inverter from the power supply to prevent a failure or accident from becoming serious upon activation of the protective function of the inverter.
 - c. Do not turn the main circuit power supply on or off to start or stop the inverter. Instead, use control circuit terminals FWD and REV or the RUN and STOP keys on the keypad panel. If it is unavoidable to turn the main circuit power supply on or off to start or stop the inverter, limit the frequency to once an hour or fewer.
 - d. Do not connect to a single-phase power supply for 3-phase input inverter.

 - (2) Inverter output terminals (U, V, W)
 - a. Connect these terminals to a 3-phase motor with the correct phase sequence. If the direction of rotation does not match the operation direction, change arbitrary two cables among the U, V and W phases.
 - b. Do not connect a phase advance capacitor or surge absorber to the inverter output.
 - c. If the wiring length between the inverter and the motor is extremely long, the stray capacity between cables causes a high frequency current, possibly tripping the inverter due to an overcurrent, increasing the leakage current, or deteriorating the current detection accuracy to cause deterioration of the performance or other phenomena. To prevent such trouble, limit the wiring length of the motor to 50 m for 4.0 kW or a smaller output or to 100 m for a larger output.
- Note: When a thermal relay is installed in the path between the inverter and the motor, or especially in the case of a 400V system, the thermal relay may malfunction even with a wiring length shorter than 50 m. In such a case, add an OFL filter or lower the Motor sound adjustment (carrier frequency) of the inverter. ... Function code F26 Motor sound adjustment.

- (3) DC reactor connecting terminals (P1, P (+))
- Use this terminal to connect a DC reactor (option). Remove the jumper connected in the factory before connecting the DC reactor.
 - Do not remove the jumper if no DC reactor is used. Cut the barrier in the main circuit terminal block cover for the P1, P (+), DB and N (-) cable port using nippers or the like when connecting wiring.

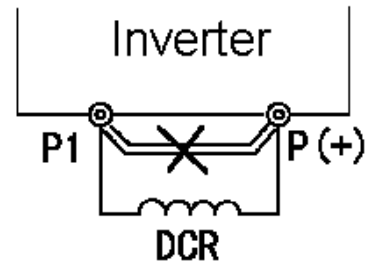

Fig. 2-3-1 DCR connection diagram

- (4) External braking resistor connecting terminals (P (+), DB)
- E11S is not equipped with a braking resistor. An external braking resistor (option) is necessary for frequent braking operation or heavy duty inertia load operation to enhance the braking performance.

- Connect the P (+) and DB terminals of the external braking resistor to the P (+) and DB terminals of the inverter.
- Arrange devices so that the wiring length is within 5 m and twist or closely (in parallel) place the two cables.

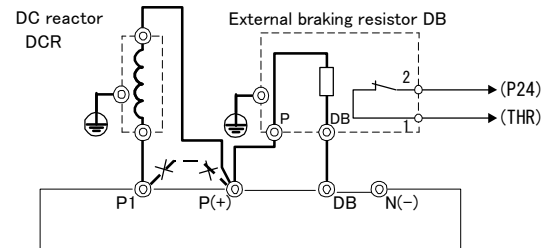

Fig. 2-3-2 Connection diagram

- (5) Inverter grounding terminal (⊕G)

Ground the grounding terminal ⊕G for safety and noise reduction without fail. The metallic frame of electrical equipment must be grounded in accordance with national or local electric code to avoid electric shock, fire and other disasters.

 CAUTION	<ul style="list-style-type: none"> Check that the number of phases and the rated voltage of the product agrees with the number of phases and the voltage of the AC power supply. Do not connect the AC power cables to the output terminals (U, V, W). Otherwise injuries could occur. Do not connect a braking resistor directly to the DC terminals (P (+), N (-)). Otherwise fire could occur.
--------------------	--

2-3-3 Connection of Control Terminal

Table 2-3-2 shows the functions of the control circuit terminals. The method of connecting control function terminals varies according to the function setting. Refer to the connection method for the function.

Table 2-3-2 Functions of control circuit terminals

Classification	Terminal symbol	Terminal name	Description of function																								
Analog input	13	Potentiometer power supply	+10 Vdc power supply for frequency setting POT. (POT: 1 to 5 kohm).																								
	12	Voltage input	(1) The frequency is set according to the external analog input voltage command. <ul style="list-style-type: none"> • 0 to +10 Vdc / 0 to 100% • Reversible operation using +/- signal: 0 to +/-10 Vdc / 0 to 100% • Inverse mode operation: +10 to 0 Vdc / 0 to 100% (2) The PID control feedback signal is input. * Input resistance: 22 kohm																								
	C1	Current input	(1) The frequency is set according to the analog input current command. <ul style="list-style-type: none"> • 4 to 20 mAdc / 0 to 100% • Inverse mode operation: 20 to 4 mAdc / 0 to 100% (2) The PID control feedback signal is input. * Input resistance 250 ohm																								
	11	Common	Common for analog signals																								
Digital input	FWD	Forward operation command	Forward operation with FWD-P24 ON and deceleration and stop with FWD-P24 OFF.																								
	REV	Reverse operation command	Reverse operation with REV-P24 ON and deceleration-stop with REV-P24 OFF.																								
	X1	Digital input 1	A coast-to-stop command from an external device, external alarm, alarm reset, multi-step frequency selection and other functions can be assigned to the X1 through X5 terminals. Refer to the terminal function E01 to 05 setting method in section 5-2 Detail Description of Each Function.																								
	X2	Digital input 2																									
	X3	Digital input 3																									
	X4	Digital input 4																									
	X5	Digital input 5																									
			<p><Digital input circuit specification></p> <table border="1"> <thead> <tr> <th colspan="2">Item</th> <th>min.</th> <th>typ.</th> <th>Max.</th> </tr> </thead> <tbody> <tr> <td rowspan="2">Operation voltage</td> <td>Level OFF</td> <td>0V</td> <td>-</td> <td>2V</td> </tr> <tr> <td>Level ON</td> <td>22V</td> <td>24V</td> <td>27V</td> </tr> <tr> <td colspan="2">Operation current at ON</td> <td>-</td> <td>4.2mA</td> <td>6mA</td> </tr> <tr> <td colspan="2">Allowable leakage current at OFF</td> <td>-</td> <td>-</td> <td>0.5mA</td> </tr> </tbody> </table>	Item		min.	typ.	Max.	Operation voltage	Level OFF	0V	-	2V	Level ON	22V	24V	27V	Operation current at ON		-	4.2mA	6mA	Allowable leakage current at OFF		-	-	0.5mA
	Item		min.	typ.	Max.																						
	Operation voltage	Level OFF	0V	-	2V																						
Level ON		22V	24V	27V																							
Operation current at ON		-	4.2mA	6mA																							
Allowable leakage current at OFF		-	-	0.5mA																							
P24	Control unit power supply	+24V DC power supply for control input. Maximum output current : 50mA																									
CM	Common	Common for digital input																									

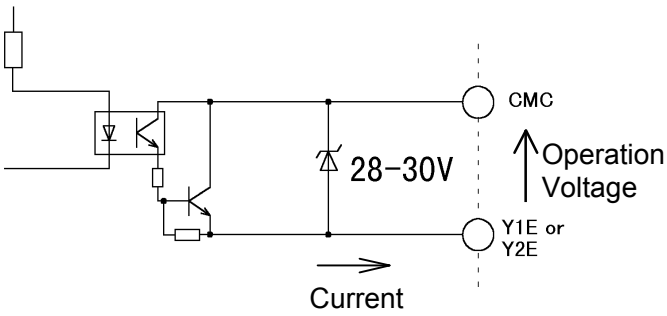
Classification	Terminal symbol	Terminal name	Description of function																					
Analog output / pulse output	FM (11: Common terminal)	Analog monitor	<p>The monitor signal for analog DC voltage (0 to +10 Vdc) is output. The signal description can be selected from the following.</p> <ul style="list-style-type: none"> • Output frequency1 (before slip compensation) • Output frequency2 (after slip compensation) • Output current • Output torque • Input power • DC link circuit voltage • Output voltage • Load factor • PID feedback value <p>* Allowable connection impedance: min. 5 k ohm</p>																					
		Pulse rate monitor	<p>The monitor signal is output according to the pulse voltage. The signal description is the same as the FMA signal.</p> <p>* Allowable connection impedance: min. 5 k ohm</p> <p>Use SW1 on the control board and function code F29 to change between the analog monitor and Pulse rate monitor. (FMA: analog monitor, FMP: Pulse rate monitor)</p>																					
Transistor output	Y1E	Transistor output 1	<p>The RUN signal, frequency equivalence signal, overload early warning signal and other signals are output to arbitrary ports at a transistor output. Refer to terminal function E20 to 21 setting methods in section 5-2 Detail Description of Each Function.</p> <p><Transistor output circuit specification></p> <table border="1"> <thead> <tr> <th>Item</th> <th>min.</th> <th>typ.</th> <th>max.</th> </tr> </thead> <tbody> <tr> <td rowspan="2">Operation voltage *1</td> <td>ON level</td> <td>-</td> <td>1V</td> <td>2V</td> </tr> <tr> <td>OFF level</td> <td>-</td> <td>24V</td> <td>27V</td> </tr> <tr> <td>Maximum load current at ON</td> <td>-</td> <td>-</td> <td>50mA</td> </tr> <tr> <td>Leakage current at OFF</td> <td>-</td> <td>-</td> <td>0.1mA</td> </tr> </tbody> </table> 	Item	min.	typ.	max.	Operation voltage *1	ON level	-	1V	2V	OFF level	-	24V	27V	Maximum load current at ON	-	-	50mA	Leakage current at OFF	-	-	0.1mA
	Item	min.		typ.	max.																			
	Operation voltage *1	ON level		-	1V	2V																		
OFF level		-	24V	27V																				
Maximum load current at ON	-	-	50mA																					
Leakage current at OFF	-	-	0.1mA																					
Y2E	Transistor output 2																							
CMC	Common (Transistor output)	Common for transistor output signal. Isolated from terminals CM and 11.																						
P24 (CM: common terminal)	DC voltage supply	Power supply for transistor output load. (24 Vdc 50 mAdc Max.) (When using P24, short the CMC and P24 terminals.) (If the P24 terminal is overloaded or connected with the CM terminal, the inverter trips with Er3 indication. To reset, remove external causes and, after several minutes, turn the inverter on again.)																						
Relay output	30A,30 B,30C	Alarm relay output	<p>When the inverter is stopped with an alarm, a relay contact output (1C) is issued.</p> <p>Contact capacity: 48 Vdc 0.5 A (When complying with UL/cUL:42Vdc 0.5A)</p> <p>Selection between excitation upon an alarm or excitation during normal operation is allowed.</p>																					

(1) Analog input terminals (13, 12, C1, 11)

- a. Because weak analog signals are handled, these signals are especially susceptible to the external noise effects. Route the wiring as short as possible (within 20 m) and use shielded cables. In principle, ground the shield of the shielded cable; if effects of external inductive noises are considerable, connection to terminal 11 may be effective.
- b. Use twin contacts relay for weak signals if relay is used in the circuit. Do not add a contact to terminal 11.
- c. When the inverter is connected with an external device outputting the analog signal, a malfunction may be caused by electric noise generated by the inverter according to some type of the circuit of the device. If this happens, connect a ferrite core or capacitor to the device outputting the analog signal.

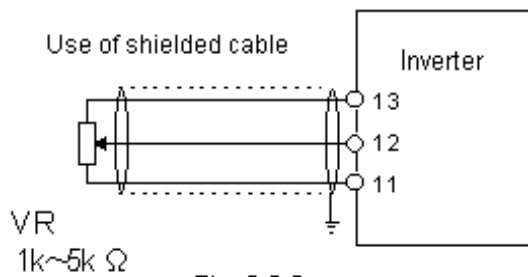

Fig. 2-3-3

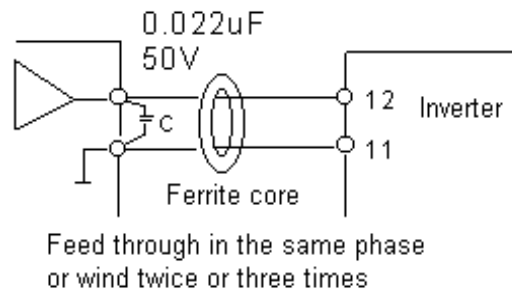

Fig.2-3-4 Countermeasure against electric noise (example)

(2) Digital input terminals (FWD, REV, X1 through X5, P24)



- a. Generally the digital input terminals (FWD, REV, X1-5) are turned on or off in relation to the P24 terminal.
- b. To use contact input, use a reliable contact free from poor contact.
Example: Control relay made by Fuji Electric: HH54PW

(3) Transistor output terminals (Y1E-Y2E, CMC)

- a. Circuit configuration shown in Table 2-3-2 for transistor output is adopted. Take care of the polarity of the external power supply.
- b. To connect a control relay, connect a surge absorbing diode across the coil of the relay.

(4) Others

- a. Route the wiring of the control terminals as far from the wiring of the main circuit as possible. Otherwise electric noise may cause malfunctions.
- b. Fix the control cables inside the inverter to keep them away from the live parts of the main circuit (such as the terminal block of the main circuit).



 WARNING	<p>If the control cables touch the live part of the main circuit, the insulation sheath of the control cable, insulation of which is not reinforced, may be broken to cause a high voltage of the main circuit to be fed to the control signal. This is banned in the low voltage directive models for Europe.</p> <p>Electric shock could occur.</p>
 CAUTION	<p>Electric noise may be generated by the inverter, motor or wiring. Take care of malfunctions of the nearby sensors and devices.</p> <p>An accident could occur.</p>

2-3-4 Terminal Layout

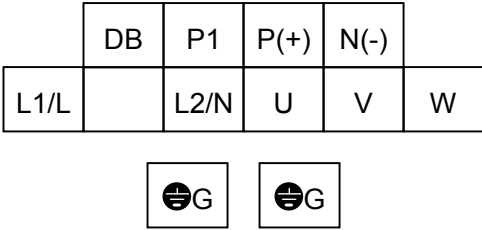
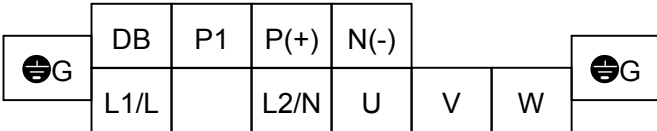
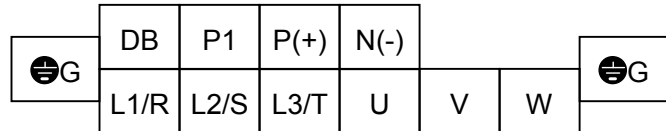
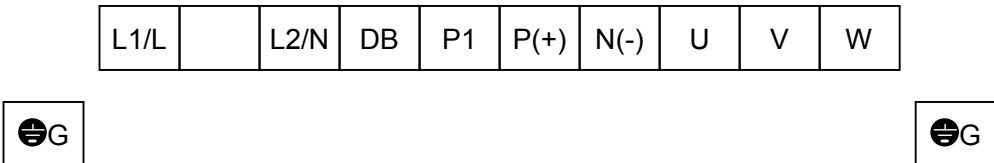
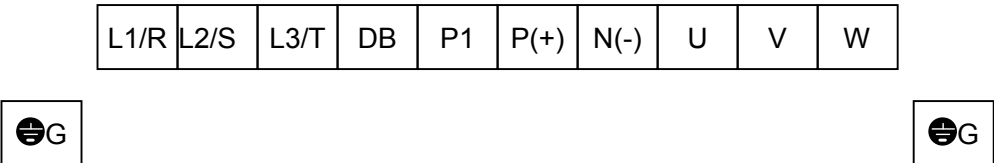
(1) Main circuit terminal block

Inverter type	Main circuit terminal drawing
FVR0.1E11S-7EN FVR0.2E11S-7EN FVR0.4E11S-7EN	 <p style="text-align: right;">Screw size : M3.5 Tightening torque : 1.2N·m</p>
FVR0.75E11S-7EN	 <p style="text-align: right;">Screw size : M4 Tightening torque : 1.8N·m</p>
FVR0.4E11S-4EN FVR0.75E11S-4EN FVR1.5E11S-4EN FVR2.2E11S-4EN	 <p style="text-align: right;">Screw size : M4 Tightening torque : 1.8N·m</p>
FVR1.5E11S-7EN FVR2.2E11S-7EN	 <p style="text-align: right;">Screw size : M4 Tightening torque : 1.8N·m</p>
FVR4.0E11S-4EN	 <p style="text-align: right;">Screw size : M4 Tightening torque : 1.8N·m</p>

(1) Main circuit terminal block(Continued)

Inverter type	Main circuit terminal drawing										
FVR5.5E11S-4EN FVR7.5E11S-4EN	<table border="1" data-bbox="552 248 1358 311"> <tr> <td>L1/R</td> <td>L2/S</td> <td>L3/T</td> <td>DB</td> <td>P1</td> <td>P(+)</td> <td>N(-)</td> <td>U</td> <td>V</td> <td>W</td> </tr> </table> <div style="display: flex; justify-content: space-between; align-items: center; margin-top: 20px;"> <div data-bbox="456 344 536 409" style="border: 1px solid black; padding: 2px;">  </div> <div data-bbox="1374 344 1453 409" style="border: 1px solid black; padding: 2px;">  </div> </div> <p style="text-align: right; margin-top: 20px;"> Screw size : M5 Tightening torque : 3.5N·m </p>	L1/R	L2/S	L3/T	DB	P1	P(+)	N(-)	U	V	W
L1/R	L2/S	L3/T	DB	P1	P(+)	N(-)	U	V	W		

(2) Control terminal block

30A	30B	Y1E	C1	FM	X1	X2	X3	X4	X5	CM
30C	Y2E	CMC	11	12	13	CM	FWD	REV	CM	P24

Screw size: M2.5
 Tightening torque: 0.4N·m

2-3-5 Applicable Devices and Cable Sizes for Main Circuit

Table 2-3-4 Selection of peripheral devices

Inverter type	Nominal applied motor [kW]	Molded case circuit breaker (MCCB) or earth leakage circuit breaker (ELCB) ^{*1} Rated current [A]		Recommended wire size [mm ²]				
				Input circuit ^{*2} [L1/R, L2/S, L3/T] [L1/L, L2/N] ⊕G		Output circuit ^{*2} [U, V, W]	DCR ^{*2} circuit [P1] [P(+)] DB	Control wiring
				With DCR	Without reactor ^{*3}			
FVR0. 1E11S-7EN	0.1	6	6	2.5	2.5	2.5	0.5	
FVR0. 2E11S-7EN	0.2		10					
FVR0. 4E11S-7EN	0.4		16					
FVR0. 75E11S-7EN	0.75	25						
FVR1. 5E11S-7EN	1.5	32						
FVR2. 2E11S-7EN	2.2	25	32	4	6	2.5 (DB) 4 (Others)		
FVR0. 4E11S-4EN	0.4	6	6	2.5	2.5	2.5	0.5	
FVR0. 75E11S-4EN	0.75		10					
FVR1. 5E11S-4EN	1.5		16					
FVR2. 2E11S-4EN	2.2	10	16					
FVR4. 0E11S-4EN	4.0	16	25					
FVR5. 5E11S-4EN	5.5	20	32					
FVR7. 5E11S-4EN	7.5	20	32					

- *1 The applicable frame and series of the model of the molded case circuit breaker (MCCB) and earth leakage breaker (ELCB) vary according to the capacity of the transformer of the equipment. For details of selection, refer to the concerning technical documents.
- *2 The recommended cable size for the main circuit is the case for the use of the PVC cable at ambient temperature 40 degree C specified in Appendix C of EN 60204
- *3 The power supply impedance without a reactor is considered to be the equivalent of 0.1% of the inverter capacity, with 10% current unbalance accompanied by the voltage unbalance.
- *4 Up to crimp terminal (JIS C2805) RAV2-3.5 with max. 7.4 mm width (including tolerance) can be used.
- *5 Up to crimp terminal (JIS C2805) RAV5.5-4 with max. 9.8 mm width (including tolerance) can be used.
- *6 Use crimp terminals with an insulating cover.

3. Operation

3-1 Inspection and Preparation Before Operation

Check the following before starting operation.

- (1) Check if connection is correct.
Especially check if the power cables are connected to inverter output terminals U, V and W and that the grounding cable is grounded without fail.
- (2) Check for short circuits between terminals and exposed live parts and ground faults.
- (3) Check for loose terminals, connectors and screws.
- (4) Check if the motor is separated from mechanical equipment.
- (5) Turn the switches off so that the inverter does not start or operate erroneously at power-on.
- (6) After the power is turned on, check the following.
 - a. Check if the keypad panel shows an alarm.
 - b. Check if the fan built in the inverter rotates. (1.5 kW or above)

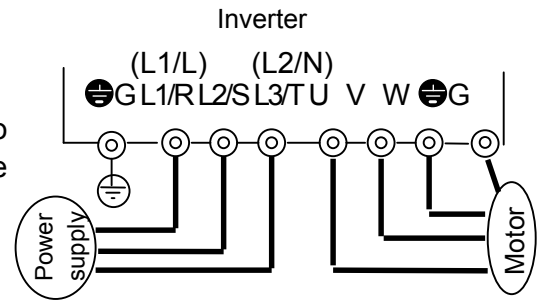

Fig. 3-1-1

Inverter connection diagram

WARNING	<ul style="list-style-type: none"> Be sure to install the terminal cover before turning the power on. Do not remove the cover during power application. Do not operate switches with wet hands. <p>Otherwise electric shock could occur.</p>
----------------	---

3-2 Operation Method

There are various operation methods. Refer to chapter 4 "Keypad Panel" and chapter 5 "Selecting Functions" to select the method most suitable for the purpose and operation specification. Table 3-2-1 shows general operation methods.

3-3 Test Operation

After checking for errors in section 3-1, perform a test operation.

In the factory shipment state, the inverter is in the keypad panel operation mode.

- (1) Turn the power on and check that the LED blinks while indicating the 0.00 Hz frequency.
- (2) Using the key, set the frequency to a low frequency such as 5 Hz.
- (3) To turn forward: F02 = 2
To reverse: F02 = 3
After setting the above, press the key to start operation. To stop, press the key.
- (4) Check the following points.
 - a. Check if the direction of rotation is correct.
 - b. Check for smooth rotation without motor humming or excessive vibration.
 - c. Check for smooth acceleration and deceleration.

- (5) Referring to function code P04 Motor 1 (auto tuning), tune the motor constant.

When no abnormality is found, raise the operation frequency to check.

After checking for correct operation during the above test operation, start normal operation.

Caution 1: If any abnormality is found to the inverter or motor, immediately stop operation and determine the cause referring to chapter 7 Troubleshooting.

Caution 2: If voltage is applied to the L1/R, L2/S and L3/T or L1/L and L2/N main circuit power supply terminals even after the inverter stops, the inverter output terminals U, V and W are live and you will be hit by electric shock when touching the terminals. As well, the smoothing capacity is not discharged immediately after the power is turned off and it takes time for the capacitor to be discharged. To touch the electric circuit after turning the power off, check that the charge lamp is unlit and check for safe voltage using a multimeter.

Table 3-2-1 General operation methods

Operation method	Frequency setting	Operation command
Operation using keypad panel	Keypad panel keys ,	Keypad panel keys ,
Operation using external signal terminal	, Potentiometer or analog voltage, current or multistep speed operation	Contact input (switch), terminals FWD-P24, terminals REV-P24

4. Keypad Panel

The keypad panel is provided with various functions such as operation (frequency setting and start/stop commands) from the keypad panel, monitor and alteration of function code data, and various confirmation functions.

Be familiar with the operation method of each function before starting operation.

4-1 Appearance of Keypad Panel

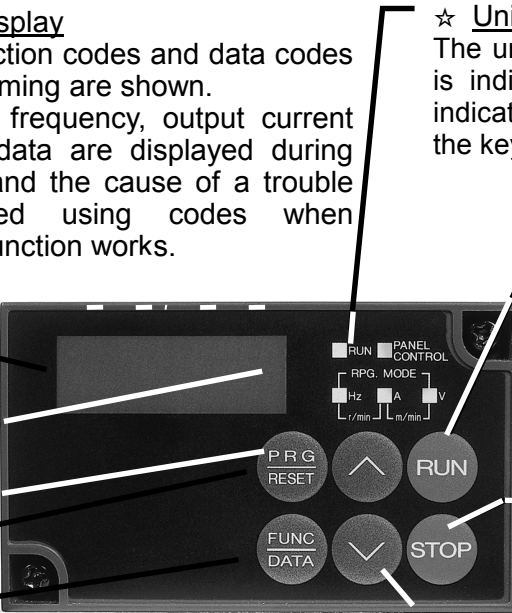

☆ Digital display
Various function codes and data codes for programming are shown. The output frequency, output current and other data are displayed during operation, and the cause of a trouble is displayed using codes when protective function works.

☆ Unit and operation mode display
The unit of the data displayed at the digital display is indicated with an LED. The program mode is indicated. The PANEL CONTROL lamp lights up in the keypad panel operation mode.

☆ RUN key
Press this key to start operation. An LED lights up during operation. When data code $\boxed{F} \boxed{} \boxed{0} \boxed{2} = \boxed{} \boxed{} \boxed{}$ $\boxed{1}$, the key does not function.

☆ STOP key
Press this key to stop operation. When data code $\boxed{F} \boxed{} \boxed{0} \boxed{2} = \boxed{} \boxed{} \boxed{}$ $\boxed{1}$, this key does not function.

☆ Function/Data key
Use this key to switch over between frequency display, output current display and other display in the regular operation mode. In the programming mode, use this key to retrieve or write various function codes and various function data.

☆ Program (PRG)/RESET key
Press this key to switch over between the regular operation mode and programming mode. Use this key to reset an alarm stopping state after activation of a protective function.

☆ Up/down keys
Press these keys to increase or decrease the frequency or speed. In the programming mode, use these keys to change the function code or data setting.

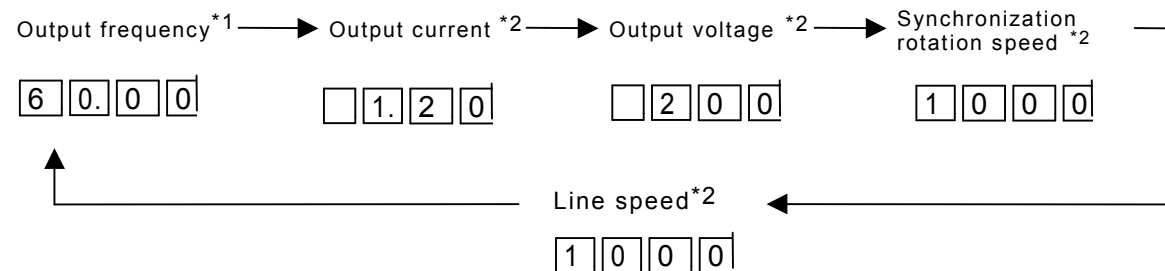

(1) Monitor switching method

In the regular operation mode, press the  key to switch between frequency display, output current display and other display.



*1: In the PID control mode (when function H20 is at "1" or "2"), the value is in the percent display and the dot at the least significant digit always lights up.

Example: 10%: 1 0. 0. ., 100%: 1 0 0. 0.

*2: Press the ,  key during display of these data to display the frequency setting.

(2) Stopping operation

When $\boxed{F}\boxed{}\boxed{0}\boxed{2}$ is other than $\boxed{}\boxed{}\boxed{}\boxed{1}$ press $\textcircled{\text{RUN}}$ to start operation or press $\textcircled{\text{STOP}}$ to stop operation. The direction of rotation is as shown below.

$\boxed{F}\boxed{}\boxed{0}\boxed{2} = \boxed{}\boxed{}\boxed{}\boxed{0}$: Forward rotation with FWD-CM ON, reverse rotation with REV-CM ON

$\boxed{F}\boxed{}\boxed{0}\boxed{2} = \boxed{}\boxed{}\boxed{}\boxed{2}$: Forward rotation (Inputs at the FWD and REV terminals are ignored.)

$\boxed{F}\boxed{}\boxed{0}\boxed{2} = \boxed{}\boxed{}\boxed{}\boxed{3}$: Reverse rotation (Inputs at the FWD and REV terminals are ignored.)

(3) Changing the frequency

When $\boxed{F}\boxed{}\boxed{0}\boxed{1}$ is at $\boxed{}\boxed{}\boxed{}\boxed{0}$, press the $\textcircled{\wedge}$ key to increase the frequency or press the $\textcircled{\vee}$ key to decrease the frequency. Press and hold the $\textcircled{\wedge}$ or $\textcircled{\vee}$ key and press the $\textcircled{\text{FUNC DATA}}$ key to increase the frequency change speed.

Note) Do not turn the power off for five seconds after performing a monitor change or function setting. Otherwise Er1 will be caused.

(4) Function setting method

	Description of operation	Operation procedure	Display result
	Initial state		$\boxed{6}\boxed{0}.\boxed{0}\boxed{0}$
1	Start the program mode.	Press the $\textcircled{\text{PRG RESET}}$ key.	$\boxed{F}\boxed{}\boxed{0}\boxed{0}$
2	Select a setting or monitoring function.	Press the $\textcircled{\wedge}$ or $\textcircled{\vee}$ key.	$\boxed{F}\boxed{}\boxed{0}\boxed{1}$
3	Have the data displayed.	Press the $\textcircled{\text{FUNC DATA}}$ key.	$\boxed{}\boxed{}\boxed{}\boxed{1}$
4	Change the data.	Press the $\textcircled{\wedge}$ or $\textcircled{\vee}$ key.	$\boxed{}\boxed{}\boxed{}\boxed{2}$
5	Store the data.	Press the $\textcircled{\text{FUNC DATA}}$ key.	$\boxed{F}\boxed{}\boxed{0}\boxed{2}$
6	Exit from the program mode. (Or select another function.)	Press the $\textcircled{\text{PRG RESET}}$ key. (Press the $\textcircled{\wedge}$ or $\textcircled{\vee}$ key.)	$\boxed{6}\boxed{0}.\boxed{0}\boxed{0}$

(5) Changing the function code

The function code consists of an alphabetic character and a numeral. The alphabetic character is defined for each of the function groups.

Table 4-1-1 Major groups of function codes

Function code	Function
F00~F42	Fundamental functions
E01~E41	Extension terminal functions
C01~C33	Control functions of frequency
P01~P10	Motor parameters
H01~H46	High performance functions
A01~A19	Alternative motor parameters

The function code changes each time the \wedge or \vee key is pressed. (Press and hold the \wedge or \vee key to continue to change the function code.)

While pressing and holding the \wedge or \vee key during function code change, press the PRG/RESET key to change to the next group with another alphabetic character. (Press the \wedge and PRG/RESET keys to jump to the top of the F, E, C, P, H or A code, or press the \vee and PRG/RESET key to jump to the last of the F, E, C, P, H or A code.)

Changing example:

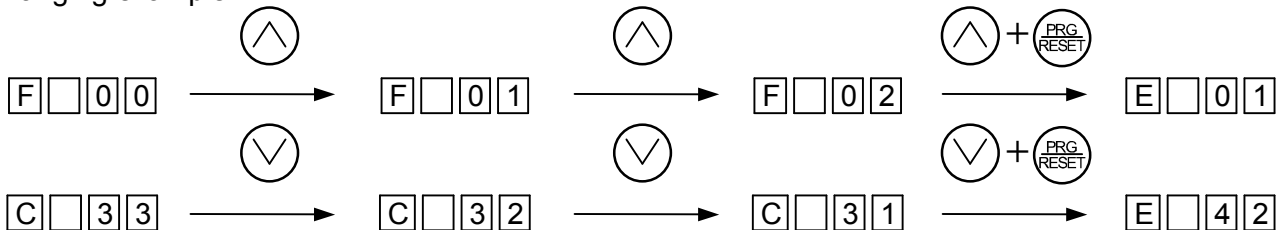

4-1-1 Upon an Alarm

When an alarm occurs, the description of the alarm is displayed. Press the \wedge or \vee key during alarm display to display the latest three alarms.

To display previous 4 alarms, select function $\text{H}\square\square0\square2$. (Refer to H02 Trip history.)

4-1-2 Digital Frequency Setting Method

Press the \wedge or \vee key at the operation mode screen. The LED display changes to the frequency setting, and the data increases or decreases in the unit of the least increment first. While the \wedge or \vee key is held down, the changing digit moves to the upper order for fast changes. Further, while pressing and holding down the \wedge or \vee key, press the FUNC/DATA key to increase the changing speed further. No special operation is necessary to store the new frequency setting. The setting is automatically stored when the inverter is turned off.

5. Selecting Functions



5-1 Function Selection List

Table 5-1-1 Function selection list

F: Fundamental functions

Function code	Name	Setting range	Min. unit	Factory setting	Change during operation	RS485 Data format	User setting
F00	Data protection	0: Data change enabled 1: Data protected	1	0	×	0	
F01	Frequency command 1	0: Keypad operation 1: Voltage input (terminal 12) 2: Current input (terminal C1) 3: Voltage and current input 4: Voltage input with polarity (terminal 12) 5: Voltage input inverse mode operation (terminal 12) 6: Current input inverse mode operation (terminal C1) 7: UP/DOWN control mode 1 8: UP/DOWN control mode 2	1	0	×	0	
F02	Operation method	0: Keypad operation (direction of rotation: input at terminal block) 1: External signal (digital input) 2: Keypad operation (forward rotation) 3: Keypad operation (reverse rotation)	1	2	×	0	
F03	Maximum frequency 1	50 to 400 Hz	1Hz	50	×	0	
F04	Base frequency 1	25 to 400 Hz	1Hz	50	×	0	
F05	Rated voltage 1 (at Base frequency1)	0V : Voltage proportional to the source voltage is output. 80 to 240V(200V class) 160 to 480V(400V class)	1V	230 400	×	0	
F06	Maximum voltage 1 (at Maximum frequency 1)	80 to 240V(200V class) 160 to 480V(400V class)	1V	230 400	×	0	
F07	Acceleration time 1	0.01 to 3600 s	0.01s	6.00	○	6	
F08	Deceleration time 1	0.01 to 3600 s	0.01s	6.00	○	6	
F09	Torque boost 1	0: Automatic torque boost 1: Square reduction torque characteristics 2: Proportional torque characteristics 3 to 31: Constant torque characteristics	1	0	○	0	
F10	Electronic thermal overload relay for motor 1 (Select)	0: Inactive 1: Active (for general purpose motors) 2: Active (for forced-ventilated motors)	1	1	△	0	
F11	(level)	20 to 135% of the rated inverter current	0.01A	Fuji's rated motor current	○	6	
F12	(Thermal time constant)	0.5 to 10.0 min.	0.1min	5.0	○	2	

Description of change during operation

- : The data changed by the ▲ or ▼ key takes effect on the inverter operation. However, press the  key to store the new data.
- △: Press the ▲ or ▼ key to change the data. The new data takes effect after the  key is pressed to store the data.
- ×: The data can be changed only while the inverter is stopped.

Function code	Name	Setting range	Min. unit	Factory setting	Change during operation	RS485 Data format	User setting
F13	Electronic thermal overload relay (for braking resistor)	0: Inactive 1: Active (for external braking resistor DB__-2C/4C) 2: Active (for external braking resistor TK80W : 0.1 to 2.2E11S-7 DB -4C : 0.4 to 7.5E11S-4)	1	0	×	0	
F14	Restart mode after momentary power failure	0: Inactive (The inverter immediately trips upon power failure.) 1: Inactive (The inverter trips after the power failure is recovered.) 2: Active (The inverter restarts at the frequency effective at the time of power failure.) 3: Active (The inverter restarts at the starting frequency.)	1	0	×	0	
F15	Frequency limiter (High)	0 to 400 Hz	1Hz	70	○	0	
F16	(Low)			0	○	0	
F17	Gain (For frequency setting signal)	0.0 to 200.0%	0.1%	100.0	○	2	
F18	Bias frequency	-400 to +400Hz	1Hz	0	○	1	
F20	DC brake (Starting frequency)	0.0 to 60.0Hz	0.1Hz	0.0	○	2	
F21	(Braking level)	0 to 100%	1%	0	○	0	
F22	(Braking time)	0.0 s (Inactive) 0.1 to 30.0s	0.1s	0.0	○	2	
F23	Starting frequency (Freq.)	0.1 to 60.0Hz	0.1Hz	0.5	×	2	
F24	(Holding time)	0.0 to 10.0s	0.1s	0.0	×	2	
F25	Stop frequency	0.1 to 6.0Hz	0.1Hz	0.2	×	2	
F26	Motor sound (Carrier frequency)	0.75,1 to 15kHz	1kHz	15	○	0	
F27	(Sound tone)	0 to 3	1	0	○	0	



○: The data changed by the ▲ or ▼ key takes effect on the inverter operation. However, press the  key to store the new data.

△: Press the ▲ or ▼ key to change the data. The new data takes effect after the  key is pressed to store the data.

×: The data can be changed only while the inverter is stopped.

Function code	Name	Setting range	Min. unit	Factory setting	Change during operation	RS485 Data format	User setting
F29	FMA and FMP terminals (Select)	0: Analog output (FMA) 1: Pulse output (FMP)	1	0	×	0	
F30	FMA (Voltage adjust)	0 to 200%	1%	100	○	0	
F31	(Function)	0: Output frequency 1 (before slip compensation) 1: Output frequency 2 (after slip compensation) 2: Output current 3: Output voltage 4: Output torque 5: Load factor 6: Input power 7: PID feedback value 8: DC link circuit voltage	1	0	△	0	
F33	FMP (Pulse rate)	300 to 6000p/s (Pulse count at 100%)	1p/s	1440	○	0	
F34	(Voltage adjustment)	0%, 1 to 200%	1%	0	○	0	
F35	(Function)	0 to 8 (Same as F31)	1	0	△	0	
F36	30Ry operation mode	0: Excited when tripping 1: Excited during regular operation	1	0	×	0	
F40	Torque limiter 1 (Driving)	20 to 200% 999: Inactive	1%	180	○	0	
F41	(Braking)	0%: Automatic deceleration control 20 to 200% 999: Inactive	1%	150	○	0	
F42	Torque vector control 1	0: Inactive 1: Active	1	0	×	0	

Description of change during operation

- : The data changed by the ▲ or ▼ key takes effect on the inverter operation. However, press the  key to store the new data.
- △: Press the ▲ or ▼ key to change the data. The new data takes effect after the  key is pressed to store the data.
- ×: The data can be changed only while the inverter is stopped.



E: Extension terminal functions

Function code	Name	Setting range	Min. unit	Factory setting	Change during operation	RS485 Data format	User setting
E01	X1 terminal function	0: Multistep frequency selection [SS1] 1: Multistep frequency selection [SS2] 2: Multistep frequency selection [SS4] 3: Multistep frequency selection [SS8]	1	0	×	0	
E02	X2 terminal function	4: Acceleration/deceleration time selection [RT1] 5: 3-wire operation stop command [HLD] 6: Coast-to-stop command [BX] 7: Alarm reset [RST]		1	×	0	
E03	X3 terminal function	8: Trip command(External fault) [THR] 9: Frequency setting 2/1 [Hz2/Hz1] 10: Motor 2/ Motor 1 [M2/M1] 11: DC brake command [DCBRK]		2	×	0	
E04	X4 terminal function	12: Torque limiter 2/Torque limiter 1 [TL2/TL1] 13: UP command [UP] 14: DOWN command [DOWN] 15: Write enable for KEYPAD [WE-KP] 16: PID control cancel [Hz/PID]		6	×	0	
E05	X5 terminal function	17: Inverse mode changeover [IVS] (terminal 12 and C1) 18: Link enable [LE]		7	×	0	
E10	Acceleration time 2	0.01 to 3600s	0.01s	10.0	○	6	
E11	Deceleration time 2			10.0	○	6	
E16	Torque limiter 2 (Driving))	20 to 200% 999: Inactive	1%	180	○	0	
E17	(Brake)	0%: Automatic deceleration control, 20 to 200% 999: Inactive	1%	150	○	0	
E20	Y1 terminal function	0: Inverter running [RUN] 1: Frequency equivalence [FAR] 2: Frequency level detection [FDT] 3: Undervoltage detection signal [LV] 4: Torque polarity [B/D]	1	0	×	0	
E21	Y2 terminal function	5: Torque limiting [TL] 6: Auto restarting [IPF] 7: Overload early warning [OL] 8: Life time alarm [LIFE] 9: Frequency level detection 2 [FAR2]		7	×	0	
E29	Frequency level detection delay	0.01 to 10.0s	0.01s	0.1	○	6	
E30	FAR function signal (Hysteresis)	0.0 to 10.0Hz	0.1Hz	2.5	○	2	
E31	FDT function signal (Level)	0 to 400Hz	1Hz	50	○	0	
E32	(Hysteresis)	0.0 to 30.0Hz	0.1Hz	1.0	○	2	
E33	OL function signal (Mode select)	0: Electronic thermal overload relay 1: Output current	1	0	△	0	
E34	(Level)	20 to 200% of the rated inverter current	0.01A	Fuji's rated motor current	○	6	
E35	(Timer)	0.0 to 60.0s	0.1s	10.0	○	2	
E40	Display coefficient A	0.00 to 200.0	0.01	0.01	○	6	
E41	B	0.00 to 200.0	0.01	0.00	○	6	
E42	LED display filter	0.0 to 5.0s	0.1s	0.5	○	2	

C: Control functions of frequency

Function code	Name	Setting range	Min. unit	Factory setting	Change during operation	RS485 Data format	User setting
C01	Jump frequency (Jump freq. 1)	0 to 400Hz	1Hz	0	○	0	
C02	(Jump freq. 2)			0	○	0	
C03	(Jump freq. 3)			0	○	0	
C04	(Hysteresis)	0 to 30Hz	1Hz	3	○	0	
C05	Multistep frequency setting (Freq. 1)	0.00 to 400.0Hz	0.01Hz	0.00	○	4	
C06	(Freq. 2)			0.00	○	4	
C07	(Freq. 3)			0.00	○	4	
C08	(Freq. 4)			0.00	○	4	
C09	(Freq. 5)			0.00	○	4	
C10	(Freq. 6)			0.00	○	4	
C11	(Freq. 7)			0.00	○	4	
C12	(Freq. 8)			0.00	○	4	
C13	(Freq. 9)			0.00	○	4	
C14	(Freq. 10)			0.00	○	4	
C15	(Freq. 11)			0.00	○	4	
C16	(Freq. 12)			0.00	○	4	
C17	(Freq. 13)			0.00	○	4	
C18	(Freq. 14)			0.00	○	4	
C19	(Freq. 15)			0.00	○	4	
C21	Timer operation	0: Inactive 1: Active	1	0	×	0	
C22	Stage 1	0.00 to 3600s	0.01s	0.00	○	6	
C30	Frequency command 2	0 to 8 (Same as F01)	1	2	×	0	
C31	Analog setting signal offset adjustment (Terminal 12)	-5.0 to +5.0%	0.1%	0.0	○	3	
C32	(Terminal C1)	-5.0 to +5.0%	0.1%	0.0	○	3	
C33	Analog setting signal filter	0.00 to 5.00s	0.01s	0.05	○	4	







Description of change during operation

- : The data changed by the ▲ or ▼ key takes effect on the inverter operation. However, press the  key to store the new data.
- △: Press the ▲ or ▼ key to change the data. The new data takes effect after the  key is pressed to store the data.
- ×: The data can be changed only while the inverter is stopped.

P: Motor parameters

Function code	Name	Setting range	Min. unit	Factory setting	Change during operation	RS485 Data format	User setting
P01	Number of motor 1 poles	2 to 14	2	4	×	0	
P02	Motor1 (Capacity)	0.01 to 5.5kW (4.0kW or less) 0.01 to 11.00kW(5.5/7.5kW)	0.01kW	Nominal applied motor kW	×	4	
P03	(Rated current)	0.00 to 99.9A	0.01A	Fuji's standard rating	×	6	
P04	(Tuning)	0: Inactive 1: Active (%R1, %X) 2: Active (%R1, %X, lo)	1	0	×	12	
P05	(Online tuning)	0: Inactive 1: Active	1	0	×	0	
P06	(No-load current)	0.00 to 99.9A	0.01A	Fuji's standard rating	×	6	
P07	(%R1 setting)	0.00 to 50.00%	0.01%	Fuji's standard rating	○	4	
P08	(%X setting)	0.00 to 50.00%	0.01%	Fuji's standard rating	○	4	
P09	(Slip compensation control 1)	0.00 to 15.00Hz	0.01Hz	0.00	○	4	
P10	(Slip compensation response time 1)	0.01 to 10.00s	0.01s	0.50	○	4	

Description of change during operation



- : The data changed by the  or  key takes effect on the inverter operation. However, press the  key to store the new data.
- △: Press the  or  key to change the data. The new data takes effect after the  key is pressed to store the data.
- ×: The data can be changed only while the inverter is stopped.

H: High performance functions

Function code	Name	Setting range	Min. unit	Factory setting	Change during operation	RS485 Data format	User setting
H01	Total operation time	Monitor only	10h	0	-	0	
H02	Trip history	Monitor only	-	----	-		
H03	Data initializing (Data reset)	0: Manual set value 1: Return to factory set value	1	0	×	0	
H04	Auto-reset (Times)	0: Inactive 1 to 10 times	1 time	0	○	0	
H05	(Reset interval)	2 to 20s	1s	5	○	0	
H06	Fan stop operation	0: Inactive 1: Active	1	0	○	0	
H07	ACC/DEC pattern (Mode select).	0: Linear acceleration/deceleration 1: S-curve acceleration/deceleration (weak) 2: S-curve acceleration/deceleration (strong) 3: Non-linear	1	0	×	0	
H09	Start mode (Rotating motor pickup mode)	0: Inactive 1: Active (only when Auto-restart after momentary power failure mode) 2: Active(All start mode)	1	1	×	0	
H10	Energy-saving operation	0: Inactive 1: Active	1	0	○	0	
H11	Dec mode	0: Normal 1: Coast-to-stop	1	0	○	0	
H12	Instantaneous overcurrent limiting	0: Inactive 1: Active	1	1	×	0	
H13	Auto-restart (Restart time)	0.1 to 5.0s	0.1s	0.1	×	2	
H14	(Frequency fall rate)	0.00 to 100.0Hz/s	0.01Hz/s	10.00	○	4	
H20	PID control (Mode select)	0: Inactive 1: Forward operation 2: Reverse operation	1	0	×	0	
H21	(Feedback signal)	0: Terminal 12 (0 to +10 Vdc) input 1: Terminal C1 (4 to 20 mA) input 2: Terminal 12 (+10 to 0 Vdc) input 3: Terminal C1 (20 to 4 mA) input	1	1	×	0	
H22	P (Gain)	0.01 to 10.00 times (1 to 1000%)	0.01 time	0.10	○	4	
H23	I (Integral time)	0.0: Inactive 0.1 to 3600s	0.1s	0.0	○	2	
H24	D (Differential time)	0.00: Inactive 0.01 to 10.0s	0.01s	0.00	○	4	
H25	(Feedback filter)	0.0 to 60.0s	0.1s	0.5	○	2	
H26	PTC thermistor (Mode select)	0: Inactive 1: Active	1	0	○	0	
H27	(Level)	0.00~5.00V	0.01V	1.60	○	4	
H28	Drift operation	-9.9~0.0Hz	0.1Hz	0.0	○	3	

Function code	Name	Setting range	Min. unit	Factory setting	Change during operation	RS485 Data format	User setting
H30	Serial link (Function select)	Monitor, Frequency, Operation 0: <input type="radio"/> <input checked="" type="radio"/> <input checked="" type="radio"/> 1: <input type="radio"/> <input type="radio"/> <input checked="" type="radio"/> 2: <input type="radio"/> <input checked="" type="radio"/> <input type="radio"/> 3: <input type="radio"/> <input type="radio"/> <input type="radio"/>	1	0	<input type="radio"/>	0	
H31	RS485 (Address)	1 to 31	1	1	<input checked="" type="radio"/>	0	
H32	(Mode select on no response error)	0: Immediate Er8 1: Er8 after interval set by timer 2: Retry in interval set by timer (Er8 after failure to restore) 3: Continuation of operation	1	0	<input type="radio"/>	0	
H33	(Timer)	0.0 to 60.0s	0.1s	2.0	<input type="radio"/>	2	
H34	(Baud rate)	0:19200[bit/s] 1:9600 2:4800 3:2400 4:1200	1	1	<input type="radio"/>	0	
H35	(Data length)	0:8bit 1:7bit	1	0	<input type="radio"/>	0	
H36	(Parity check)	0: None 1: Even parity 2: Odd parity	1	0	<input type="radio"/>	0	
H37	(Stop bits)	0: 2 bits 1: 1 bit	1	0	<input type="radio"/>	0	
H38	(No response error detection time)	0: Not detected 1 to 60s	1s	0	<input type="radio"/>	0	
H39	(Response interval)	0.00 to 1.00s	0.01s	0.01	<input type="radio"/>	4	
H40	Maximum temperature of heat sink	Monitor only	degree C	-	-	0	
H41	Maximum effective current	Monitor only	A	-	-	6	
H42	Main circuit capacitor life	Monitor only	0.1%	-	-	0	
H43	Cooling fan operation time	Monitor only	10h	-	-	0	
H44	Inverter ROM version	Monitor only	-	-	-	0	
H45	Keypad panel ROM version	Monitor only	-	-	-	0	
H46	Option ROM version	Monitor only	-	-	-	0	



Description of change during operation

- : The data changed by the or key takes effect on the inverter operation. However, press the  key to store the new data.
- : Press the or key to change the data. The new data takes effect after the  key is pressed to store the data.
- : The data can be changed only while the inverter is stopped.

A: Alternative motor parameters

Function code	Name	Setting range	Min. unit	Factory setting	Change during operation	RS485 Data format	User setting
A01	Maximum frequency 2	50 to 400Hz	1Hz	50	×	0	
A02	Base frequency 2	25 to 400Hz	1Hz	50	×	0	
A03	Rated voltage 2 (at base frequency 2)	0V, 80 to 240V(200V class) 0V, 160 to 480V(400V class)	1V	230 400	×	0	
A04	Maximum voltage 2 (at maximum frequency 2)	80 to 240V (200V class) 160 to 480V(400V class)	1V	230 400	×	0	
A05	Torque boost 2	0,1,2,3 to 31	1	0	○	0	
A06	Electronic thermal overload relay for motor 2 (Select)	0: Inactive 1: Active (for general purpose motors) 2: Active (for inverter motors)	1	1	△	0	
A07	(level)	20 to 135% of the rated inverter current	0.01A	Fuji's rated motor current	○	6	
A08	(Thermal time constant)	0.5 to 10 min.	0.1min	5.0	○	2	
A09	Torque vector control 2	0:Inactive 1:Active	1	0	×	0	
A10	Number of motor 2 poles	2 to 14	2	4	×	0	
A11	Motor 2 (Capacity)	0.01 to 5.5kW (4.0kW or smaller) 0.01 to 11.00kW(5.5/7.5kW)	0.01kW	Nominal applied motor kW	×	4	
A12	(Rated current)	0.00 to 99.9A	0.01A	Fuji's standard rating	×	6	
A13	(Tuning)	0: Inactive 1: Active (%R1, %X) 2: Active (%R1, %X, I _o)	1	0	×	12	
A14	(Online tuning)	0: Inactive, 1: Active	1	0	×	0	
A15	(No-load current)	0.00 to 99.9A	0.01A	Fuji's standard rating	×	6	
A16	(%R1 setting)	0.00 to 50.00%	0.01%	Fuji's standard rating	○	4	
A17	(%X setting)	0.00 to 50.00%	0.01%	Fuji's standard rating	○	4	
A18	(Slip compensation control 2)	0.00 to 15.00Hz	0.01Hz	0.00	○	4	
A19	(Slip compensation response time 2)	0.01 to 10.00s	0.01s	0.50	○	4	



Description of change during operation

- : The data changed by the ▲ or ▼ key takes effect on the inverter operation. However, press the  key to store the new data.
- △: Press the ▲ or ▼ key to change the data. The new data takes effect after the  key is pressed to store the data.
- ×: The data can be changed only while the inverter is stopped.

o: Optional functions

Function code	Name	Setting range	Min. unit	Factory setting	Change during operation	RS485 Data format	User setting
o00	Optional selection	0: Option inactive 1: Option active Set 0 when optional card is not used.	-	0	○	0	

Description of change during operation

- : The data changed by the ▲ or ▼ key takes effect on the inverter operation. However, press the  key to store the new data.
- △: Press the ▲ or ▼ key to change the data. The new data takes effect after the  key is pressed to store the data.
- ×: The data can be changed only while the inverter is stopped.

5-2 Detail Description of Each Function

F: Fundamental functions



F00 Data protection

◆ The setting data can be protected against inadvertent operation at the keypad panel.

0: Data change enabled

1: Data protected



[Setting method]

0→1: Press the  +  keys simultaneously.

1→0: Press the  +  keys simultaneously.

F01 Frequency command 1

◆ The frequency setting method can be selected.

0: The frequency is set by the operation of  and  keys.

1: The frequency is set by the voltage input (at terminal 12) (0 to +10 Vdc).

2: The frequency is set by the current input (at terminal C1) (4 to 20 mAdc).

3: The frequency is set by the voltage input and current input (terminal 12 and terminal C1) ((-10 to +10 Vdc) + (4 to 20 mAdc)). Inputs at terminals 12 and C1 are added to determine the frequency.

4: The frequency is set by the voltage input with polarity (at terminal 12) (-10 to +10 Vdc). In the case of input with polarity, operation at a direction opposite to the operation command is possible.

5: The frequency is set by voltage input inverse mode operation (at terminal 12) (+10 to 0 Vdc).

6: The frequency is set by current input inverse mode operation (at terminal C1) (20 to 4 mAdc).

7: UP/DOWN control mode 1

The frequency is set by terminal UP, terminal DOWN. (initial value = 0)

8: UP/DOWN control mode 2

The frequency is set by terminal UP, terminal DOWN (initial value = last value during previous operation).

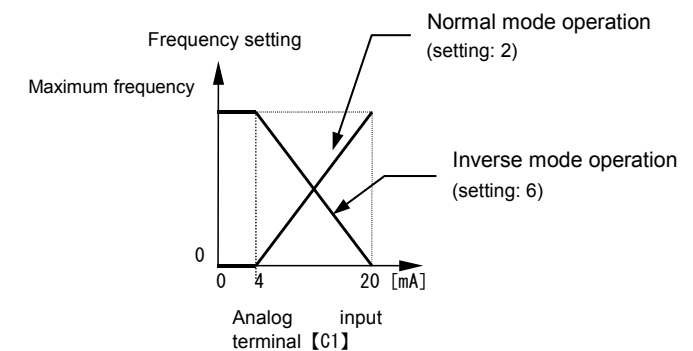
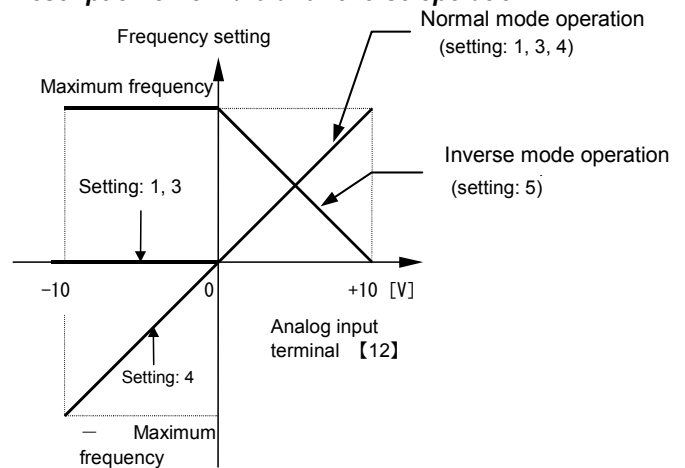

Refer to the description of the E01 to E05 functions for details.

Description of forward and reverse operation



F02 Operation method

◆ The operation input method is set. (Note: This function can be changed only when the FWD and REV terminals are open.)

0: The motor starts or stops upon keypad operation ( or  key).

The direction of rotation is determined by the FWD and REV terminals on the control terminal block as follows.

FWD-P24 short-circuited: Forward rotation

REV-P24 short-circuited: Reverse rotation

The motor does not start if both the FWD and REV terminals are connected with the P24 terminal or both of them are open.

1: External signal (digital input)



The motor starts or stops upon the state of the FWD and REV terminals on the control terminal block.

FWD-P24 short-circuited: forward rotation



REV-P24 short-circuited: reverse rotation

The motor does not start if both the FWD and REV terminals are connected with the P24 terminal or both of them are open.

2: Keypad operation (forward rotation only)

The motor runs in the forward direction when the  key is pressed and it decelerates to stop when the  key is pressed.

3: Keypad operation (reverse rotation only)

The motor runs in the reverse direction when the  key is pressed and it decelerates to stop when the  key is pressed.

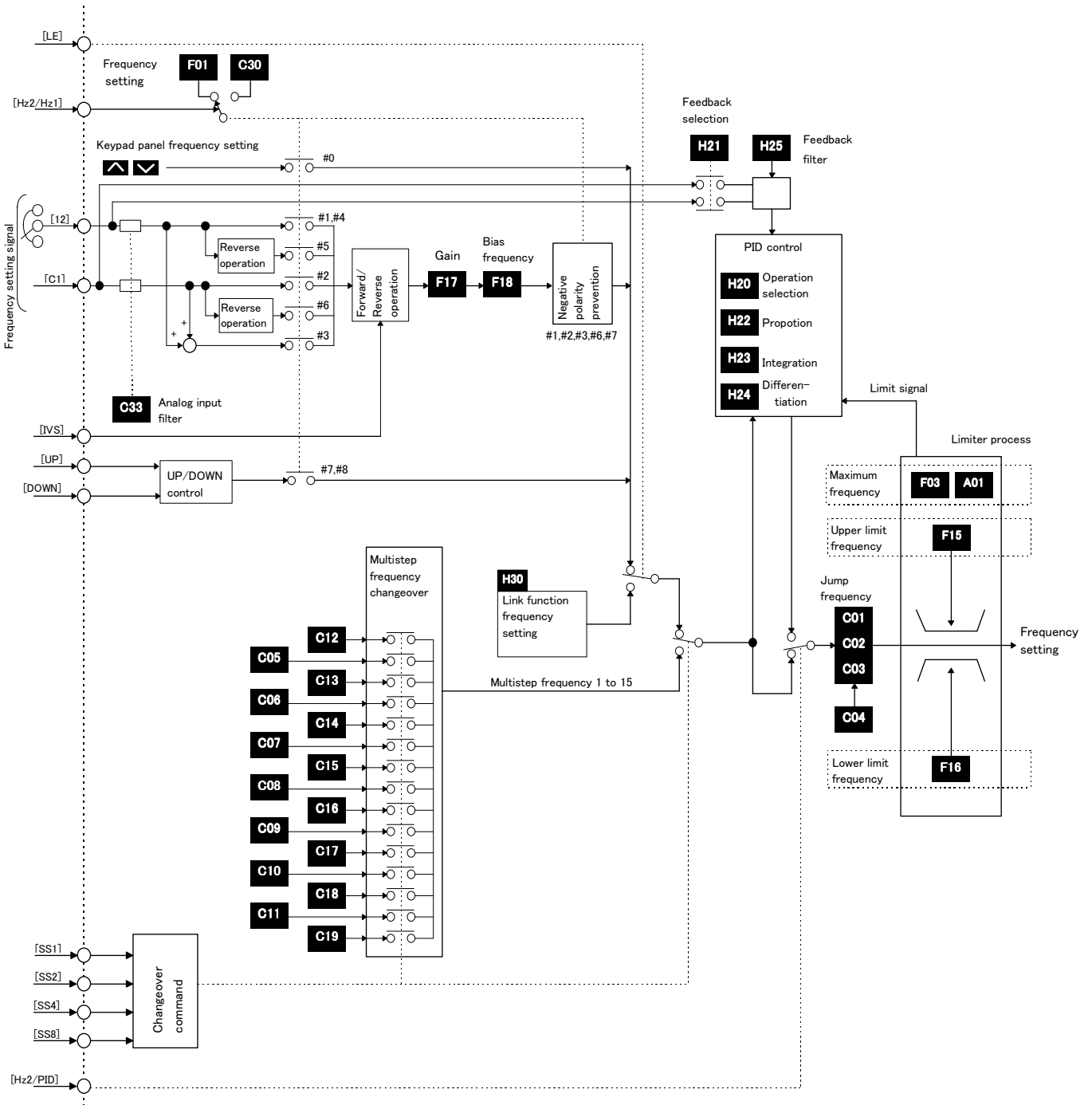

Frequency setting block diagram

F03 Maximum frequency 1

- ◆ This is the maximum frequency which is output by the inverter of motor 1.
Setting range: 50 to 400 Hz
If a value larger than the rating of the driven unit is set, the motor or machine may be broken. Set a value suitable for the driven unit.

F04 Base frequency 1

- ◆ This is the maximum output frequency in the constant torque zone of motor 1, that is, the output frequency at the rated output voltage.
Set the rating of the motor.
Setting range: 25 to 400 Hz

Note) If the setting of base frequency 1 is larger than the setting of maximum frequency 1, the output frequency is limited by the maximum frequency and the output voltage does not rise to the rated voltage.

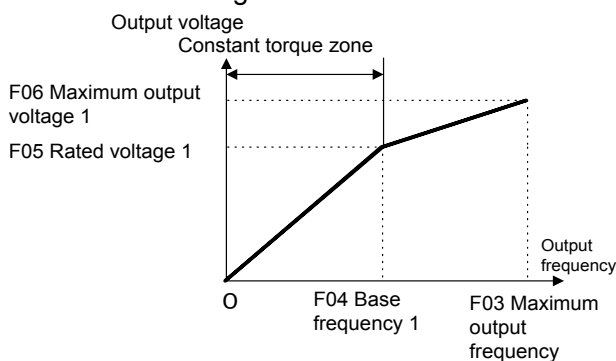

F05 Rated voltage 1

- ◆ This is the output voltage value at base frequency 1 which is output to motor 1. However, voltages exceeding the source (input) voltage cannot be output.
Setting range: 0, 80 to 240 V for 200V class
0, 160 to 480 V for 400V class
A "0" setting stops the operation of the voltage adjustment function. Therefore a voltage proportional to the source voltage is output.

Note) If the setting of rated voltage 1 is larger than the setting of maximum output voltage 1, the voltage is limited by the maximum output voltage and it does not rise to the rated voltage.

F06 Maximum voltage 1

- ◆ This is the maximum value of the output voltage of the inverter of motor 1. However, voltages exceeding the source (input) voltage cannot be output.
Setting range: 0, 80 to 240 V for 200V class
0, 160 to 480 V for 400V class

F07 Acceleration time 1

F08 Deceleration time 1

- ◆ These are the acceleration time taken for the output frequency to reach the maximum frequency from the start, and the deceleration time taken to stop from the maximum output frequency.

Setting range: Acceleration time 1: 0.01 to 3600 s
Deceleration time 1: 0.01 to 3600 s

The number of significant digits of the acceleration and deceleration time is three. Therefore the uppermost three digits can be set.

The acceleration time and deceleration time are set based on the maximum frequency. The relationship between the frequency setting and the acceleration/deceleration time is as shown below.

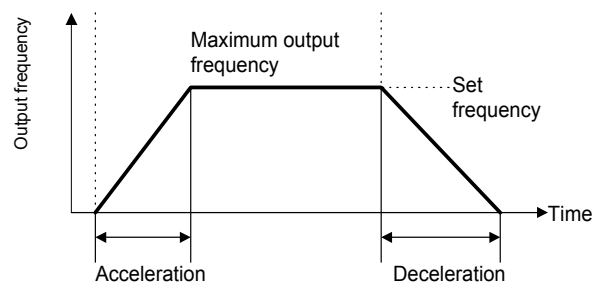

Set frequency < Maximum output frequency

The setting differs from the actual operation time.

Acceleration/deceleration time

$$= \text{Setting} \times (\text{Set frequency} / \text{Maximum output frequency})$$

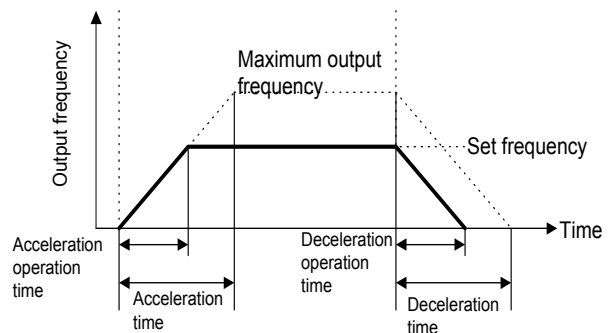

Note) If an excessively short acceleration or deceleration time is set though the load torque or moment of inertia of the load is large, the torque limiter or stall prevention function is activated. When these functions are activated, the time becomes longer than the operation time explained above.

F09 Torque boost 1

- ◆ This function is for motor 1. The following options can be selected.
 - Selection of load characteristics such as automatic torque boost, square reduction torque load, proportional torque load and constant torque load.
 - Correction of magnetic flux shortage of motor in accordance with the voltage drop in low frequency zone, and torque boost during low speed operation (boosting of V/f characteristics).

Setting range	Description of selection
0	Automatic torque boost characteristics where the torque boost value of the constant torque load is automatically adjusted (refer to function code P04 "Motor 1 ("Tuning)").
1	Square reduction torque characteristics for fan and pump loads
2	Proportional torque characteristics for intermediate load between the square reduction torque and torque characteristics.
3 to 31	Constant torque characteristics

- ◆ Torque characteristics
 - <Square reduction torque characteristics>
 - <Proportional torque characteristics>

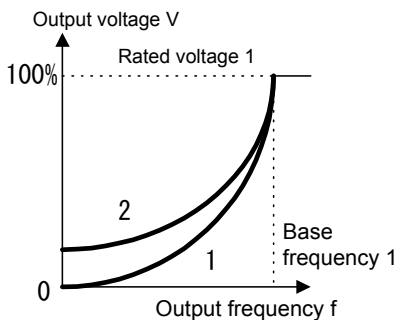

<Constant torque characteristics>

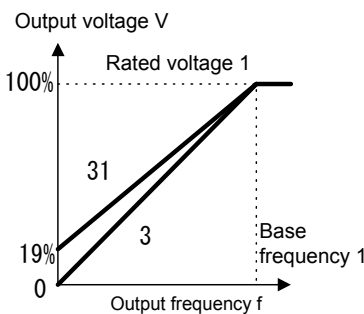

Note) When the torque boost value is excessively large, the motor is excessively excited in the low speed zone at all types of characteristics. If operation continues in such a state, the motor may be overheated. Set a value according to the characteristics of the driven motor.

F10 Electronic thermal overload relay 1 (Select)

F11 Electronic thermal overload relay 1 (Level)

F12 Electronic thermal overload relay 1 (Thermal time constant)

The electronic thermal overload relay watches the output frequency, output current and operation time of the inverter to prevent the motor from overheat. The protective function becomes active when 150% of the set amperage flows for the time set at F12 (thermal time constant).

F10

- ◆ Selection between active and inactive operation of the electronic thermal overload relay and selection of the target motor are made. When the general purpose motor is selected, the operation level is low at low revolution speeds according to the cooling characteristics of the motor.
 - Setting: 0 Inactive
 - 1 Active (for general purpose motor)
 - 2 Active (for forced-ventilated motor)

F11

- ◆ The operation level of the electronic thermal overload relay is set in amperage. Enter the value 1.0 to 1.1 times rated current of the motor. The setting range is 20 to 135% of the rated inverter current.

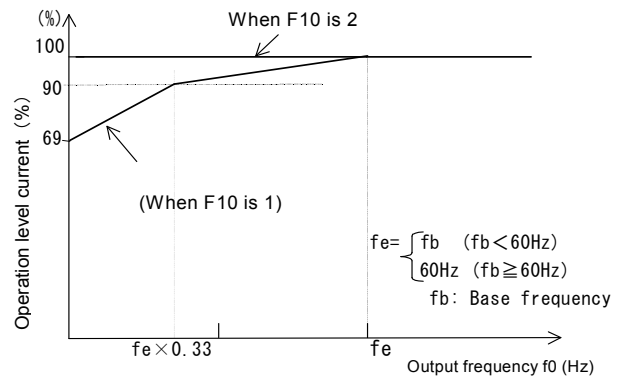

Graph of relationship between operation level current and output frequency

F12

Set the time since 150% of the operation level current flows continuously until the electronic thermal overload relay functions. Setting range: 0.5 to 10.0 min.

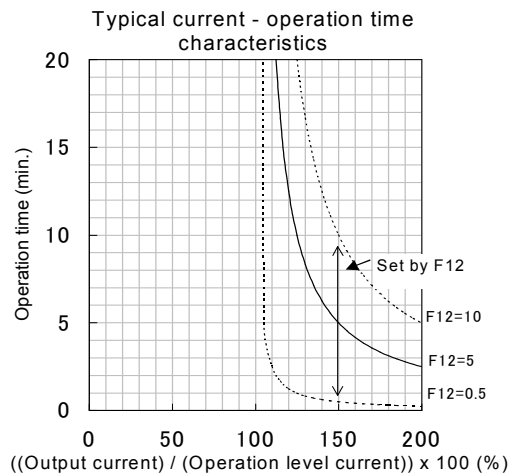

(minimum unit 0.1 minute)

F13 Electronic thermal overload relay (for External braking resistor)

- ◆ This function controls the operation frequency of the braking resistor and the continuous operation hours to prevent the braking resistor from being overheated.

Setting

0: Inactive

1: Active (For external braking resistor DB□□□-2C/4C)

2: Active (For external braking resistor TK80W120 Ω) [0.1 to 2.2E11S-7]

Active (For external braking resistor DB□□□-4C) [0.4 to 7.5E11S-4]

F14 Restart mode after momentary power failure

- ◆ Select the operation to be taken by the inverter upon momentary power failure.
You can select between protective operation (alarm output, alarm display, and inverter output shutoff) upon detection of power failure to be taken against an undervoltage and restart after momentary power failure where the coasting motor is not stopped but automatically restarted after the source voltage is recovered.

Setting range: 0 to 3 (Refer to the table below for details of the function.)

Setting	Name of function	Operation upon power failure	Operation upon power recovery	
0	Inactive after momentary power failure (The inverter trips immediately.)	Upon detection of an undervoltage, a protective function is activated to stop the output.	The inverter does not restart.	The inverter restarts after the protective function is reset.
1	Inactive after momentary power failure (The inverter trips after the power is recovered.)	Upon detection of an undervoltage, no protective function is activated but the output is stopped.	A protective function is activated; the inverter does not restart.	and an operation command is input.
2	Restart after momentary power failure (The inverter restarts at the frequency effective at the time of power failure.)	Upon detection of an undervoltage, no protective function is activated but the output is stopped.	The inverter automatically restarts at the output frequency effective at the time of power failure.	
3	Restart after momentary power failure (The inverter restarts at the starting frequency; for low inertia loads.)	Upon detection of an undervoltage, no protective function is activated but the output is stopped.	The inverter automatically restarts at the starting frequency set at F23.	

Function codes used for the restart after momentary power failure include H13 and H14. Refer to the description of these codes, too. As well, a rotating motor pickup function can be selected as a starting method after a momentary power failure. (Refer to function code H09 for details of setting.) When the pickup function is used, the speed of the coasting motor is detected and the motor is started without a shock. Because a speed detection time is necessary if the pickup function is made effective, the pickup function should be made ineffective and restart should be made at the frequency effective before the power failure in a system with a large inertia to restore the original frequency, to make the most of the small decrease in the speed of the coasting motor. The effective range of the pickup function is 5 to 120 Hz. If the detected speed is out of the effective range, the inverter restarts according to the regular function of restart after momentary power failure.

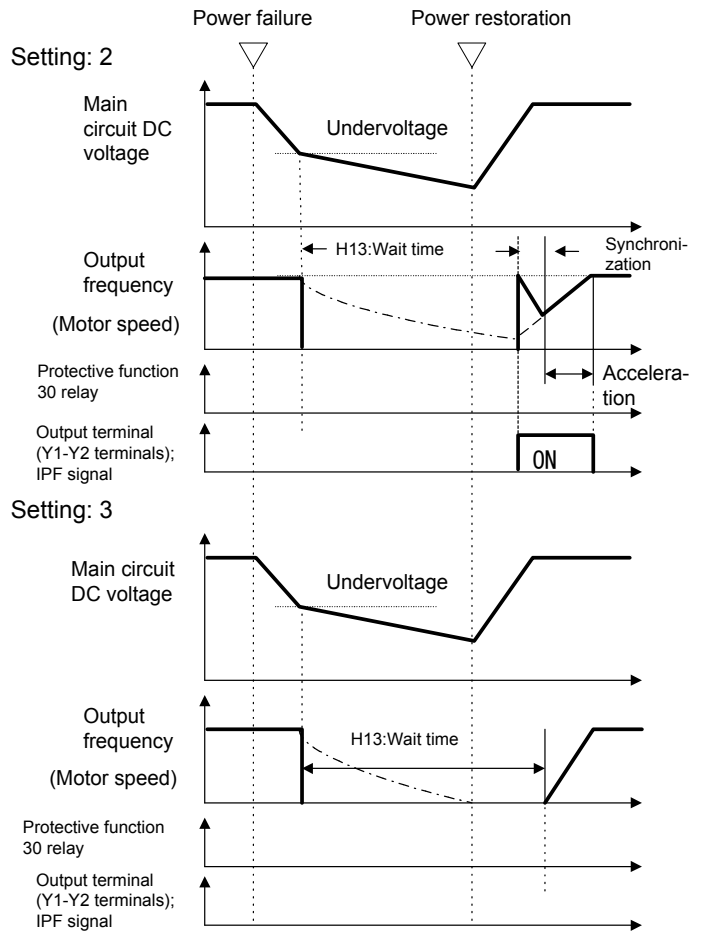
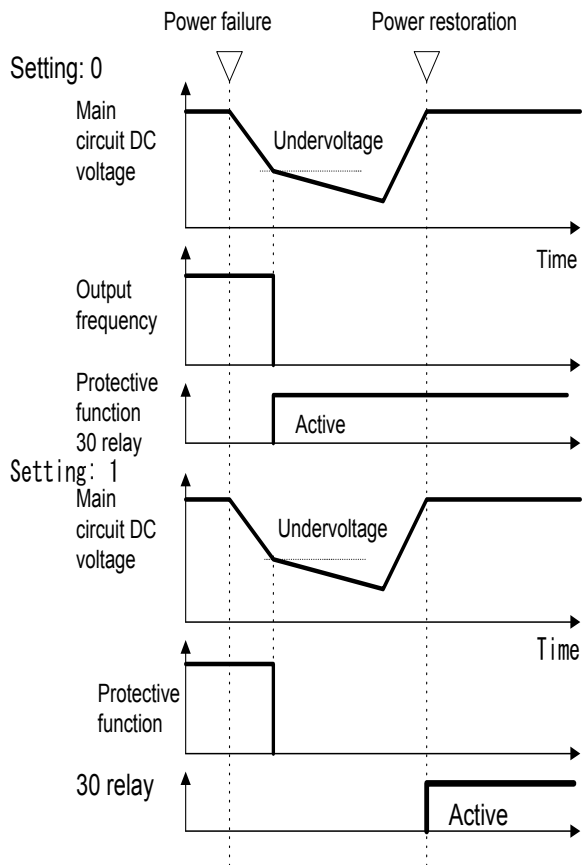

Note: The chain line indicates the motor speed.

F15 Frequency limiter (High)

F16 Frequency limiter (Low)

- ◆ Set the upper and lower limits of the frequency setting.
Setting range: 0 to 400 Hz

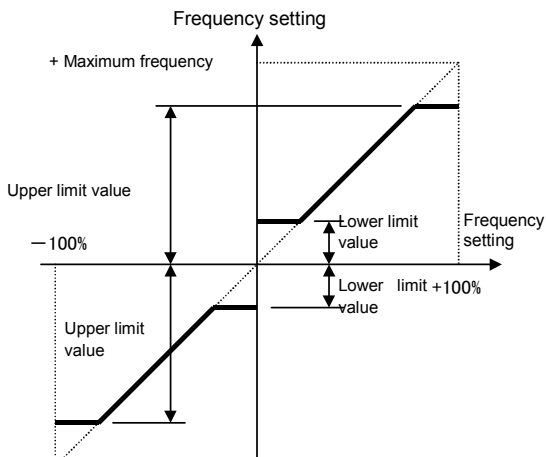

- *The starting frequency is output when the inverter starts operation, and the stopping frequency is output when it stops operation.
- *(Low limit) > (High limit) ... Priority is given to the High limit value.

F17 Gain (Frequency setting signal)

- ◆ Set the ratio of the frequency setting in relation to the analog input.
The operation is as shown in the figure below.

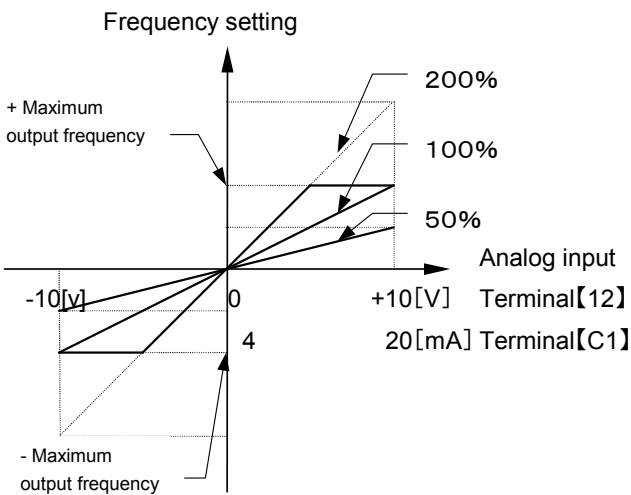

F18 Bias frequency

This function obtains the frequency setting from addition of the frequency setting in relation to the analog input and a bias frequency. The operation is as shown in the figure below. However, if the bias frequency is larger (smaller) than the maximum frequency (-maximum frequency), the limit is set at the maximum output frequency (- maximum output frequency).

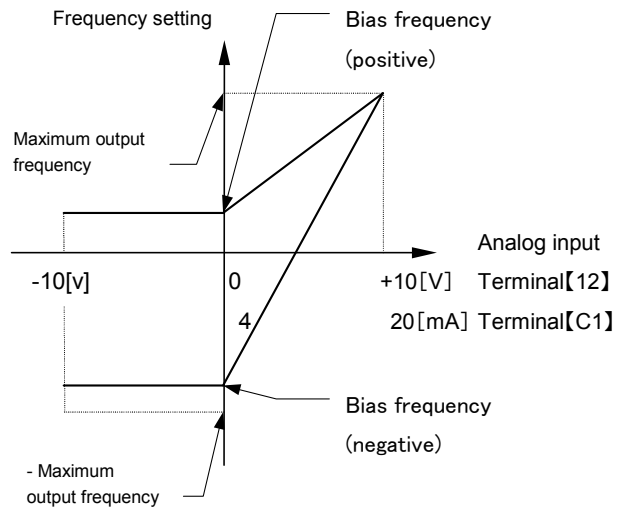

F20 DC brake (Starting frequency)

F21 DC brake (Braking level)

F22 DC brake (Braking time)

F20

- ◆ Starting frequency: Set the frequency at which the DC brake starts operation during deceleration and stop.
Setting range: 0.0 to 60.0 Hz

F21

- ◆ Braking level: Set the output current level during DC braking. The level can be set in an increment of 1% of the rated inverter output current.
Setting range: 0 to 100%
Actual minimum level is fixed to 5% even if this function set from 1 to 5% for 5.5/7.5E11S-4EN.

F22

- ◆ Braking time: Set the operation time of DC braking.
Setting range: 0.0 Inactive
0.1 to 30.0 s

<p>CAUTION</p>	<p>The brake function of the inverter does not insure the function of a mechanical latch. Injuries could occur.</p>
-----------------------	--

F23 Starting frequency(Frequency)

F24 Starting frequency (Holding time)

F25 Stop frequency

◆ The starting frequency can be set to insure the torque during start of operation. Holding time for at the starting frequency before acceleration can be set to wait for establishment of the magnetic flux of the motor during start of operation.

F23

◆ Frequency: Set the starting frequency.
Setting range: 0.1 to 60.0 Hz

F24

◆ Holding time: Set the time for continuing the starting frequency during start of operation.

Setting range: 0.0 to 10.0 s

*The Holding time is not placed during changeover between forward and reverse rotation.

*The Holding time is not included in the acceleration time.

*The function is effective even when C21 Timer operation is selected; the time is included in the timer value.

F25

◆ Set the stop frequency.
Setting range: 0.1 to 6.0 Hz

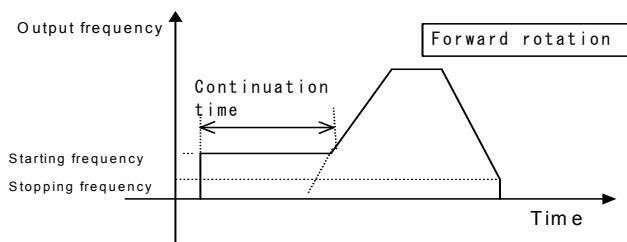

When the starting frequency is smaller than the stop frequency and the frequency setting is smaller than the stop frequency, operation does not start.

F26 Motor sound (Carrier frequency)

◆ This function adjusts the carrier frequency. After adjustment, reduction of the motor noise, avoidance of resonance with the mechanical system, reduction of leakage current from the output circuit wiring, reduction of inverter noise and other effects can be obtained.

Setting range: 0.75 to 15 (0.75 to 15 kHz)

Carrier frequency	Lower	Higher
Motor noise	Larger	Smaller
Output current waveform	Worse	Better
Leakage current	Less	More
Noise generation	Less	More

* A smaller setting causes a worse output current waveform (with much harmonic component) to cause an increase in the motor loss, resulting in a slightly higher motor temperature.

For example, when 0.75 kHz is set, reduce the

motor torque by about 15%. When a large value is set, the inverter loss increases, raising the inverter temperature.

F27 Motor sound (Sound tone)

◆ The sound tone of the motor noise can be changed when the carrier frequency is 7 kHz or lower. Use the function according to preference.
Setting range: 0, 1, 2, 3

F29 FMA and FMP terminals (Select)

◆ Select the operation method of the FM terminal.
0: Analog output (FMA function)
1: Pulse output (FMP function)

F30 FMA (Voltage adjust)

F31 FMA (Function)

The output frequency, output current and other monitor data can be output to the FM terminal in a DC voltage. The amplitude can be adjusted.

Note) To use the FM terminal for analog outputs, set F29 at "0" and set SW1 on the control board to FMA.

F30

◆ Adjust the voltage corresponding to 100 [%] of the monitoring amount of the monitoring item selected at F31 in a range from 0 to 200 [%] (in an increment of 1 [%]).
Setting range: 0 to 200 [%]

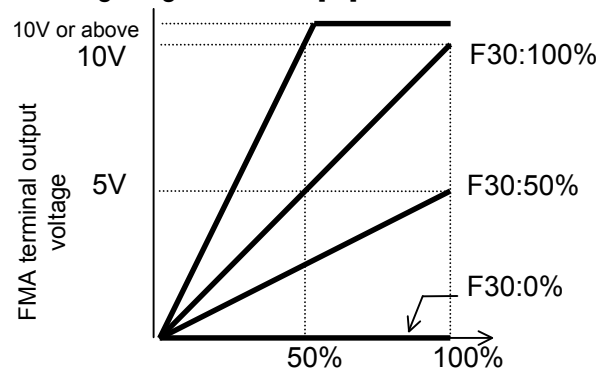

F31

- ◆ Select the monitoring item to be output at the FM terminal.

Setting	Target of monitoring	Definition of 100% of monitoring amount
0	Output frequency 1 (before slip compensation)	Maximum output frequency
1	Output frequency 2 (after slip compensation)	Maximum output frequency
2	Output current	2 times rated inverter output current
3	Output voltage	250V (200V class) , 500V (400V class)
4	Output torque	2 times rated motor torque
5	Load factor	2 times rated motor load
6	Input power	2 times rated inverter output
7	PID feedback value	100% feedback value
8	DC link circuit voltage	500V (200V class) 1000V (400V class)

F33 FMP (Pulse rate)**F34 FMP (Voltage adjust)****F35 FMP (Function)**

The output frequency, output current and other monitor data can be output at the FM terminal in pulse voltages. The average voltage can be connected to an analog meter.

To select the pulse output and connect a digital counter or the like, set the F33 pulse rate to a desired value and set the F34 voltage to 0%.

To select the average voltage and connect an analog meter, set the F34 voltage to determine the average voltage; the F33 pulse rate is fixed at 2670 [p/s].

Note) To use the FM terminal for the pulse output, set F29 to "1" and set SW1 on the control board to the FMP side.

F33

- ◆ Set the pulse frequency corresponding to 100 [%] of the monitoring amount of the monitoring item selected by F35 in a range from 300 to 6000 [p/s].

Setting range: 300 to 6000 [p/s]

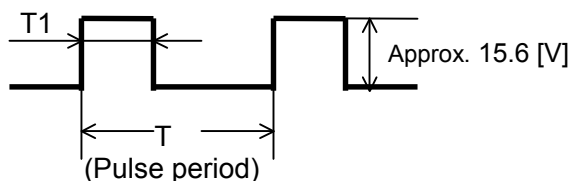

$$\text{Pulse period [p/s]} = 1/T$$

$$\text{Duty [\%]} = T1/T \times 100$$

$$\text{Average voltage [V]} = 15.6 \times T1/T$$

F34

- ◆ Set the average voltage of the pulse output at the FM terminal.

Setting range: 0 to 200 [%]

However, if "0" is set, the pulse frequency varies according to the monitoring amount of the monitoring item selected at F35 (with the maximum value being the F33 setting). If a value between 1 and 200 is set, the pulse frequency is fixed at 2670 [p/s]. The average voltage corresponding to 100 [%] of the monitoring amount of the monitoring item selected at F35 is adjusted in a range between 1 and 200 [%] (in an increment of 1 [%]). (The duty of the pulse changes.)

Note : FMP has approx. 0.2V offset voltage even if FMP outputs zero value.

F35

Select the monitoring item to be output at the FM terminal. The options to be selected are the same as F31.

F36 30Ry operation mode

- ◆ Select whether the alarm output relay (30Ry) of the inverter is activated (excited) during normal operation or during a trip.

Setting	Description of operation
0	During normal operation 30A—30C : OFF 30B—30C : ON Upon a trip 30A—30C : ON 30B—30C : OFF
1	During normal operation 30A—30C : ON 30B—30C : OFF Upon a trip 30A—30C : OFF 30B—30C : ON

Note) Because the contact between 30A and 30C is on after the inverter is turned on (after about 1 second since the power is turned on) when the setting is "1", care must be taken to the sequence design.

F40 Torque limiter 1 (Driving)

F41 Torque limiter 1 (Braking)

- ◆ The torque limiting operation calculates the motor torque from the output voltage, current, resistance of the primary winding of the motor and other data to control the frequency so that the calculated value does not exceed the control value. This operation insures inverter operation without tripping upon abrupt changes in the load torque while the limit value is maintained.
- ◆ Select the limit values of the driving torque and braking torque.
- ◆ The acceleration/deceleration operation time during activation of this function becomes longer than the set acceleration/deceleration time. When the driving torque is limited during constant speed operation, the frequency is lowered to reduce the load torque. (When the braking torque is limited, the contrary occurs.)

Setting range: 20 to 200,999%

Set "999" to inactivate the torque limiter.

Set only the braking torque to "0" to automatically avoid OU tripping caused by power regeneration.

 WARNING	<ul style="list-style-type: none">• If the torque limiter has been selected, the inverter may operate at an acceleration/deceleration time or speed different from the set ones. Design the machine so that safety is ensured even in such cases. Otherwise an accident could occur.
--	---

F42 Torque vector control 1

- ◆ The torque vector control calculates the torque suitable for the load to make the most of the motor torque, and controls the voltage and current vectors to optimum ones according to the calculated value.

Setting	State of operation
0	Inactive
1	Active

- ◆ When "1" (active) is selected, the settings of the following function codes become different from the written ones.
 - 1) F09 "Torque boost 1"
Works as "0" value (automatic torque boost).
 - 2) P09 "Slip compensation control"
Slip compensation is automatically activated.
When "0" is set, the slip compensation amount of a Fuji's standard three-phase motor is assumed.
When the setting is other than "0", the written setting is applied.
- ◆ Use the torque vector control function under the following conditions.
 - 1) A single motor
If two or more motors are connected, accurate control is difficult.
 - 2) The data of function codes of motor 1 (P03 "Rated current", P06 "No-load current", P07 "%R1" and P08 "%X") must be accurate.
If the standard three-phase motor made by Fuji is used, the above data is automatically input when function code P02 "Capacity" is set. When another motor is used, perform auto tuning.
 - 3) The rated motor current must not be too smaller than the rated inverter current. Though it depends on the model, the one smaller by two ranks than the standard applicable motor of the inverter is the allowable smallest motor.
 - 4) The wiring distance between the inverter and motor must be up to 50 m. Too long a wiring distance disables accurate control due to the leakage current flowing through the static capacity between the cable and the ground.
 - 5) When a reactor is connected between the inverter and the motor or when the wiring impedance is large enough to be overlooked, change the data using P04 "Auto tuning".
If these conditions cannot be satisfied, change the setting to "0" (inactive).

(E:Extension Terminal Functions)

E01 X1 terminal function

E02 X2 terminal function

E03 X3 terminal function

E04 X4 terminal function

E05 X5 terminal function

◆ The function of each digital input terminal X1 to X5 can be set arbitrarily using a code.

Setting	Function
0,1,2,3	Multistep frequency selection (1 to 15 steps)
4	Acceleration/deceleration selection (1 step)
5	Self holding selection [HLD]
6	Coast-to-stop command [BX]
7	Error reset [RST]
8	External alarm [THR]
9	Frequency setting 2 / frequency setting 1 [Hz2 / Hz1]
10	Motor 2 / motor 1 [M2 / M1]
11	DC brake command [DCBRK]
12	Torque limit 2 / torque limit 1 [TL2 / TL1]
13	UP command [UP]
14	DOWN command [DOWN]
15	Write enable for keypad (data change allowed) [WE-KP]
16	PID control cancel [Hz / PID]
17	Forward/reverse operation switch (terminal 12 and terminal C1) [IVS]
18	Link operation selection (RS485 standard, BUS Option) [LE]

Note) The data numbers not assigned to E01 through E05 are considered to be inactive.

Multistep frequency

Frequencies set to function codes C05 through C19 can be selected according to external digital input signal switching. Set data 0 to 3 to the desired digital input terminals and combination of input signals determines the selected frequency.

Multistep frequency selection

Combination of input signals				Selected frequency
3 [SS8]	2 [SS4]	1 [SS2]	0 [SS1]	
off	off	off	off	Selected by F01 or C30
off	off	off	on	C05 Multistep frequency 1
off	off	on	off	C06 Multistep frequency 2
off	off	on	on	C07 Multistep frequency 3
off	on	off	off	C08 Multistep frequency 4
off	on	off	on	C09 Multistep frequency 5
off	on	on	off	C10 Multistep frequency 6
off	on	on	on	C11 Multistep frequency 7
on	off	off	off	C12 Multistep frequency 8
on	off	off	on	C13 Multistep frequency 9
on	off	on	off	C14 Multistep frequency 10
on	off	on	on	C15 Multistep frequency 11
on	on	off	off	C16 Multistep frequency 12
on	on	off	on	C17 Multistep frequency 13
on	on	on	off	C18 Multistep frequency 14
on	on	on	on	C19 Multistep frequency 15

Acceleration/deceleration time selection

Acceleration/deceleration time set to function codes E10 and E11 can be selected according to external digital input signal switching.

Input signal	Selected acceleration/deceleration time
4[RT1]	
off	F07 Acceleration time 1 F08 Deceleration time 1
on	E10 Acceleration time 2 E11 Deceleration time 2

3-wire operation stopcommand [HLD]

Used for three-wire operation. When HLD-P24 is ON, the FWD or REV signal is maintained, and when it is OFF, the signal is reset.

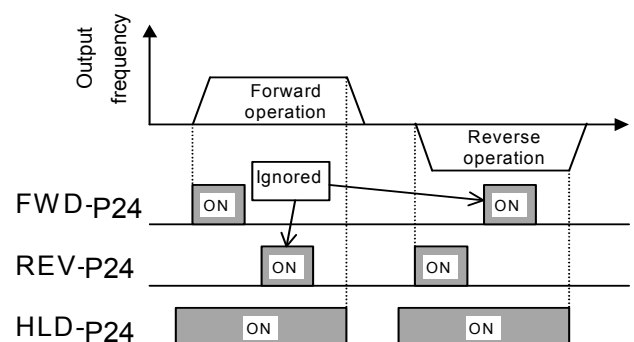

Note : The inverter operates while FWD-P24 or REV-P24 is ON even if HLD-P24 is OFF. An external interlock sequence ,which makes FWD-P24 and REV-P24 OFF when HLD-P24 is OFF, is required.

Coast-to-stop command [BX]

When the BX terminal is connected to the P24 terminal, the inverter output is immediately shut off and the motor coasts to stop. No alarm signal is output. This signal is not maintained.

When the operation command (FWD or REV) is ON and the BX terminal is disconnected from the P24 terminal, the motor starts at the starting frequency.

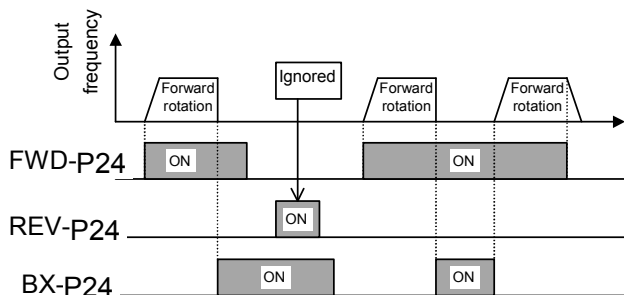

Alarm reset [RST]

Upon tripping, when the connection between the RST and P24 terminals is turned on, the batch alarm output is removed, and when the connection is turned off, the trip display is removed and operation is restarted.

Trip command (External fault) [THR]

When the connection between the THR and P24 terminals is turned off, the inverter output is shut off (to allow the motor to coast to stop), and an alarm [OH2] is output. This signal is maintained internally until an RST input is added. This function is used to protect the external braking resistor from being overheated. When this terminal function is not set, an ON input is assumed.

Frequency setting 2/1 [Hz2 / Hz1]

An external digital input signal switches the frequency setting method defined by function codes F01 and C30.

The signal operation is changed under PID control. (Refer to H20 through H25.)

Input signal	Selected frequency setting
9[Hz2/Hz1]	
off	F01 Frequency setting 1
on	C30 Frequency setting 2

Motor 2/1 [M2 / M1]

An external digital input signal switches each motor constant. However, this input is effective only when the operation command to the inverter is turned off and the inverter is stopped. Therefore operation at 0 Hz is not included.

Input signal	Selected motor
10[M2/M1]	
off	Motor 1
on	Motor 2

DC brake command [DCBRK]

When the external digital input signal is ON, DC braking starts and continues as far as the signal remains turned on after the operation command is turned off (or, the STOP key is pressed in the keypad panel operation mode or both the FWD and REV terminals are turned on or turned off in the terminal block operation mode) and the inverter frequency drops below the frequency set at F20. In this case, the longer time between the time set at function code F22 and the time when the input signal is turned on, is given priority.

However, operation is restarted if the operation command is turned on.

Torque limiter 2/Torque limiter 1 [TL2 / TL1]

An external digital input signal switches between the torque limiter values set at function codes F40 and F41 or E16 and E17.

Input signal	Selected torque limit value
12[TL2/TL1]	
off	F40 Torque limiter 1 (Driving) F41 Torque limiter 1 (Braking)
on	E16 Torque limiter 2 (Driving) E17 Torque limiter 2 (Braking)

UP command [UP] / DOWN command [DOWN]

The output frequency can be increased or decreased according to the external digital input signal while the operation command is input (turned on). The changing range is 0 to the maximum output frequency and operation in a direction opposite to that in the operation command is impossible.

Input signal		Selected function
13	14	(when operation command is ON)
off	off	The output frequency is maintained.
off	on	The output frequency increases at the acceleration time.
on	off	The output frequency decreases at the deceleration time.
on	on	The output frequency is maintained.

Write enable for KEYPAD [WE-KP]

This function allows program changes only while the external signal is input; this is for the protection of the program from inadvertent changes.

Input signal	Selected function
15[WE-KP]	
off	Data change disabled
on	Data change enabled

Note) If data 15 is set to a terminal erroneously, program change become disabled. Turn the terminal ON then change to another number.

PID control cancel [Hz/PID]

An external digital input signal can disable PID control.

Input signal	Selected function
16 [Hz/PID]	
off	PID control valid
on	PID control invalid (frequency setting through keypad panel)

Inverse mode changeover(Terminal 12 and C1) [IVS]

An external digital input signal switches between the forward and reverse operations of analog inputs (terminals 12 and C1).

Input signal	Selected function
17 [IVS]	
off	When forward operation is set →forward operation When reverse operation is set →reverse operation
on	When forward operation is set →reverse operation When reverse operation is set →forward operation

Link enable (RS485) [LE]

An external digital input signal is switched to validate or invalidate the frequency command and operation command from the link. The source of the command can be set at H30 Link function.

Input signal	Selected function
18 [LE]	
off	Link command invalid
on	Link command valid

E10 Acceleration time 2

E11 Deceleration time 2

- ◆ Additional acceleration and deceleration time can be selected besides F07 "Acceleration time 1" and F08 "Deceleration time 1".
- ◆ The operation and setting range are the same as those for F07 "Acceleration time 1" and F08 "Deceleration time 1". Refer to these functions.
- ◆ To switch between the acceleration and deceleration time, select any terminal from among E01 "X1 terminal (Function selection)" through E05 "X5 terminal (Function selection)" as a switching signal input terminal. Set the selected terminal to "4" (acceleration/deceleration time selection) and supply a signal to the terminal to switch. Switching is effective during acceleration, during deceleration or during constant speed operation.

E16 Torque limiter 2 (Driving)

E17 Torque limiter 2 (Braking)

- ◆ Use these functions to switch the torque limiter levels set at F40 and F41 using an external control signal. The external signal is supplied to an arbitrary control terminal among X1 through X5, the function of which is set to torque control 2 / torque control 1 (data 12) at E01 to E05.

E20 Y1 terminal function

E21 Y2 terminal function

- ◆ A part of control and monitor signals can be output at the Y1 and Y2 terminals.

Setting	Output signal
0	Inverter running [RUN]
1	Frequency equivalence [FAR]
2	Frequency level detection [FDT]
3	Undervoltage detection signal [LV]
4	Torque polarity [B/D]
5	Torque limiting [TL]
6	Auto restarting [IPF]
7	Overload early warning [OL]
8	Life time alarm [LIFE]
9	Frequency level detection 2 [FAR2]

Inverter running [RUN]

"Inverter running" means that the inverter outputs a frequency as a speed signal. At this time, an ON signal is output. However, if the DC braking function is active, the signal is turned off.

Frequency equivalence [FAR]

Refer to the description for function code E30 Frequency equivalence (detection width).

Frequency level detection [FDT]

Refer to the description for function codes E31 and E32 Frequency level detection.

Undervoltage detection signal [LV]

When the undervoltage protection function is active, that is, when the main circuit DC voltage is below the undervoltage detection level, an ON signal is output. After the voltage is restored to become higher than the undervoltage detection level, the signal is turned off. The ON signal is output also during activation of the undervoltage protection function.

Undervoltage detection level: Approx 200 Vdc
(200V class)
: Approx 400Vdc
(400V class)

Torque polarity [B/D]

The polarity of the torque calculated inside the inverter is judged and the driving/braking torque discrimination signal is output.

When the calculated torque is the driving torque, an OFF signal is output, and when it is the braking torque, an ON signal is output.

Torque limiting [TL]

When the torque limit is set, a stall prevention function automatically functions to change the output frequency automatically; the torque limiting signal is output externally to reduce the load or to indicate an excessive load at the monitor.

The ON signal is output during torque limit, regeneration avoidance operation and current limit.

Auto restarting [IPF]

An event of momentary power failure, start-up of restart mode after momentary power failure, and automatic synchronization and recovery are reported to the outside.

When the power is recovered and synchronization starts after a momentary power failure, an ON signal is output, and the signal changes to the OFF signal after the frequency before the momentary power failure is achieved.

In the startup at the starting frequency mode, completion of restart is assumed at the time of power recovery, and the signal is turned off in this timing. (Refer to the description for F14.)

Overload early warning [OL]

An overload early warning level before thermal protection trip (electronic thermal overload relay) of the motor is judged and an ON signal is output. Either the electronic thermal overload forecast or output current overload forecast can be selected for overload forecast judgement.

For the setting method, refer to Overload early warning (Operation selection) (E33) and Overload early warning (Operation level) (E34).

Note) This function is effective only for motor 1.

Life time alarm [LIFE]

Life judgement output for main circuit capacitor
Refer to section 8-2 (1) "Capacity measurement of main circuit capacitor" for description.

Frequency level detection 2 [FAR2]

This is a frequency level detection (detection width) signal where function code E29 "Frequency level detection delay" takes effect. Detection level of the frequency is detected at the output frequency before the torque limiter.

E29 Frequency level detection delay

E30 FAR function signal (Hysteresis)

◆ Adjust the hysteresis and signal output delay for achievement of the output frequency to the set frequency (operation frequency).

The delay is valid only for FAR2 and it can be adjusted between 0.01 and 10.0 seconds. The hysteresis can be adjusted in a range of 0 to +/-10 Hz of the output frequency.

The output frequency changes according to the torque limiting operation. When the frequency exceeds the setting range (width), the signal is turned off in a mode (FAR: E20, 21 set to "1") or it is not turned off in another mode (FAR2: E20, 21 set to "9").

E29: Setting range: 0.01 to 10.0 s

E30: Setting range: 0.0 to 10.0 Hz

An ON signal can be output from the terminal within the detection range (width).

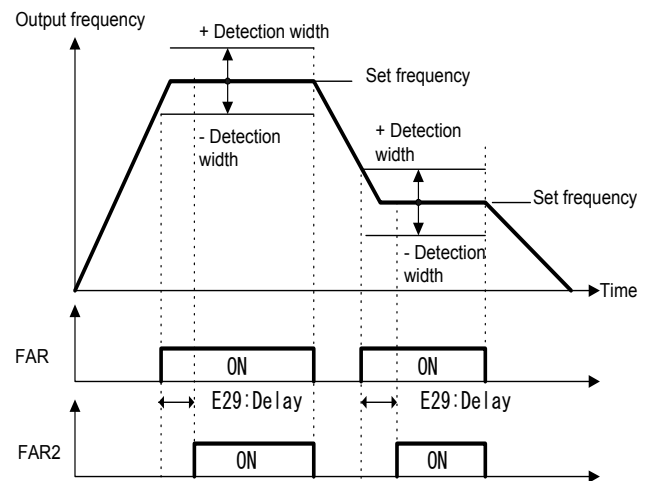

E31 FDT function signal (Level)

E32 FDT function signal (Hysteresis)

◆ Determine the operation (detection) level of the output frequency and the hysteresis width for operation cancellation. When the output frequency exceeds the set operation level, an ON signal can be output from the terminal.

Setting range: (Operation level): 0 to 400 Hz

(Hysteresis width): 0.0 to 30.0 Hz

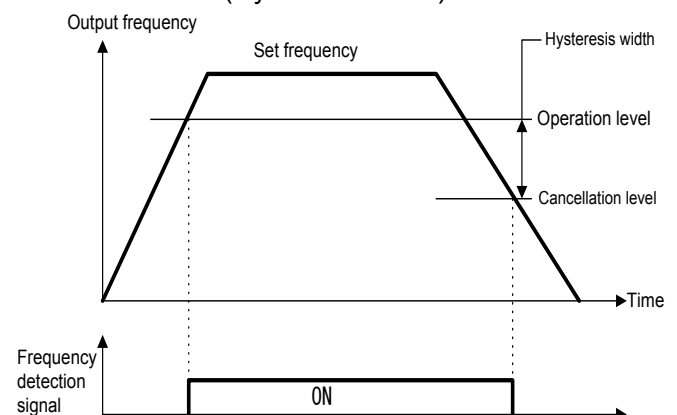

E33 OL function signal (Mode select)

- ◆ The OL function signal includes two variations: "overload forecast by means of the function of the electronic thermal overload relay" and "overload forecast by means of output current".
Setting: 0 Electronic thermal overload relay
1 Output current

Setting	Function	Outline
0	Electronic thermal overload relay	Overload forecast using the characteristics of the electronic thermal overload relay which show inverse time limit characteristics against the output current. The operation selection of the inverse time limit characteristics and the thermal time constant are the same characteristics as those of the electronic thermal overload relay (F10, F12) for motor protection. To use for the forecast, set an earlier output than the electronic thermal overload relay for motor protection.
1	Output current	When the output current exceeds the set current for a period longer than the set time, an overload forecast is issued.

E34 OL function signal (Level)

Determine the level of the electronic thermal overload relay or output current.

Setting range:

Rated inverter output current x (20 to 200%)
The operation cancellation level is 90% of the set value.

E35 OL function signal (Timer)

- ◆ When E33 "OL function signal (Mode select)" is set at "1" (output current), set the time taken until the forecast is issued.

Setting range: 0.1 to 60.0 s

E40 Display coefficient A

E41 Display coefficient B

- ◆ Use these functions as conversion coefficients for determining the display value (process amount) of the load speed, line speed and target value and feedback amount of the PID adjuster.

Setting range

Display coefficient A: 0.00 to 200.0

Display coefficient B: 0.00 to 200.0

- ◆ Load speed and line speed

Use E40 "Display coefficient A".

(Displayed value) = (Output frequency) x (0.01 to 200.0)

The effective value of the display data is 0.01 to 200.0. Therefore the display is limited by the minimum value of 0.01 and the maximum value of 200.0 even if the value exceeds the range.

- ◆ Target value and feedback amount of PID adjuster

Set the maximum value of the display data at E40 "Display coefficient A" and set the minimum value at E41 "Display coefficient B".

Display value = (Target value or feedback amount) x (Display coefficient A - B) + B

Display value

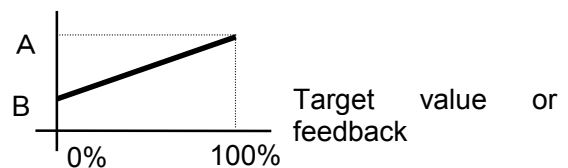

E42 LED display filter

The data of "LED monitor" includes data for which display of the changing moment is not necessary. This type of data can be provided with a filter for flicker prevention.

Setting range: 0.0 to 5.0 s

- ◆ The target display items are the output current and output voltage.

C: Control Functions of Frequency

C01 Jump frequency 1

C02 Jump frequency 2

C03 Jump frequency 3

C04 Jump frequency hysteresis

- ◆ These functions jump the inverter output frequency at the set frequencies to avoid mechanical resonance with the load.
- ◆ Three jump frequencies can be set.
- ◆ This function is inactive when all the jump frequencies 1 through 3 are set at 0 Hz.
- ◆ The frequencies are not jumped during acceleration or deceleration.
If the setting ranges of jump frequencies overlap, the sum of the setting ranges is jumped.

C01 C02 C03

Setting range: 0 to 400 Hz
Minimum unit: 1 Hz

C04

Setting range: 0 to 30 Hz
Minimum unit: 1 Hz

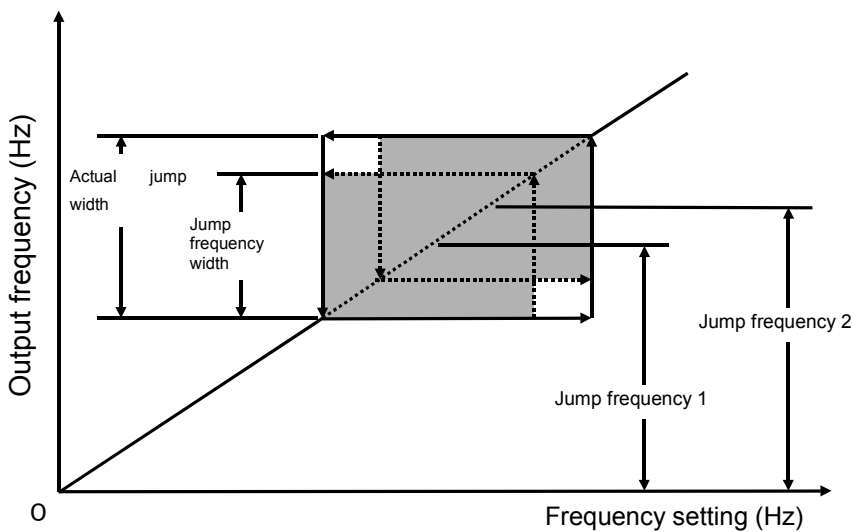
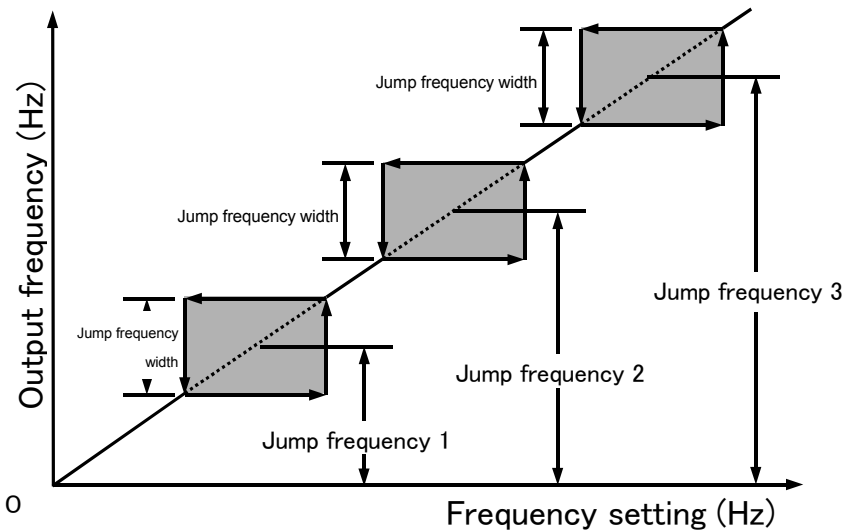

C05 Multistep frequency 1 through C19 Multistep frequency 15

- ◆ Terminal functions SS1, SS2, SS4 and SS8 are turned on or off to switch multistep frequencies 1 through 15. (Refer to E01 through E05 for the definition of the terminal function.)
- ◆ Undefined terminals among terminal functions SS1, SS2, SS4 and SS8 are assumed to be turned off.
Setting range: 0.00 to 400.0 Hz
Minimum unit: 0.01 Hz

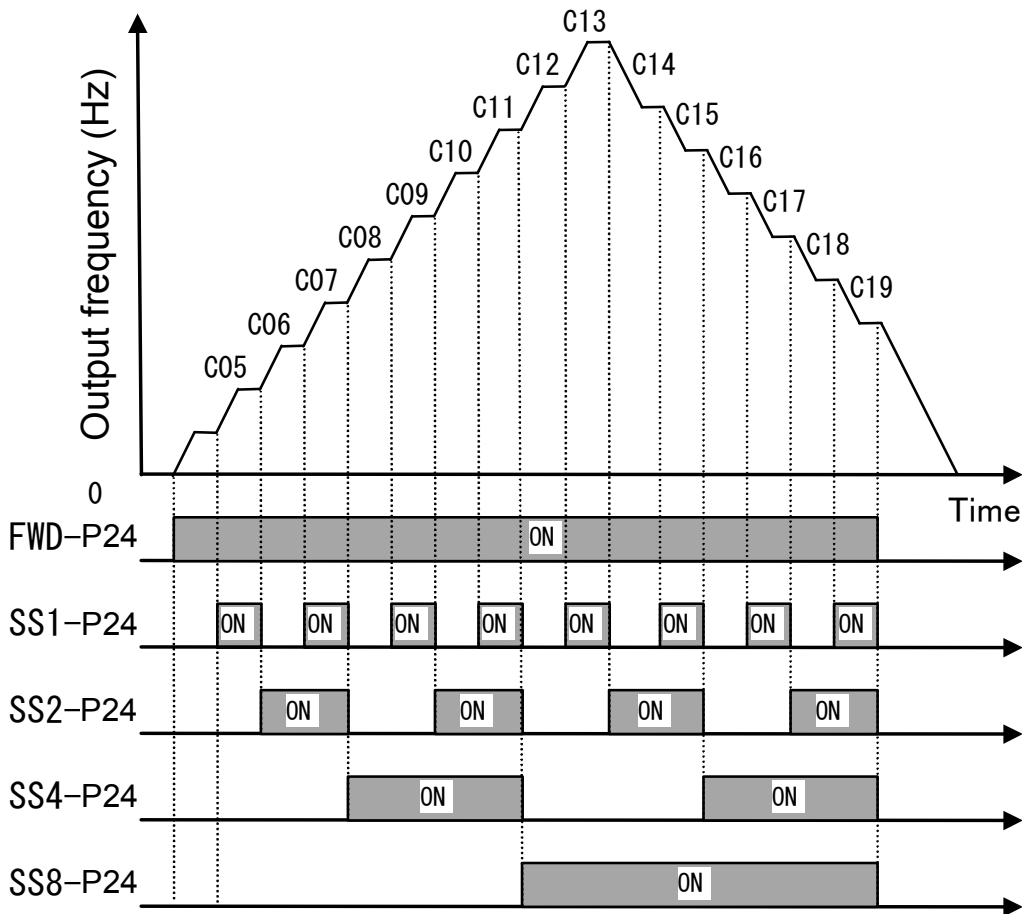

C21 *Timer operation*

C22 *Stage 1*

- ◆ An operation pattern from the start of operation to automatic stop can be created.

C21

- ◆ Select active or inactive timer operation.
0: Inactive timer operation
1: Active timer operation

C22

- ◆ Set the time from the start of operation to automatic stop.

Setting range: 0.00 to 3600 s

Note) If the power is turned off or the inverter is stopped or trips during timer operation, the counted time is reset.

C30 *Frequency command 2*

- ◆ Select the frequency setting method.
For the selectable frequency setting methods, refer to the description of F01.

C31 *Analog setting signal offset adjustment (Terminal 12)*

C32 *Analog setting signal offset adjustment (Terminal C1)*

- ◆ Set the offset of the analog input (terminal [12], terminal [C1]).
The offset can be set in the range between -5.0 [%] and + 5.0 [%] of the maximum output frequency (in 0.1 [%] step).

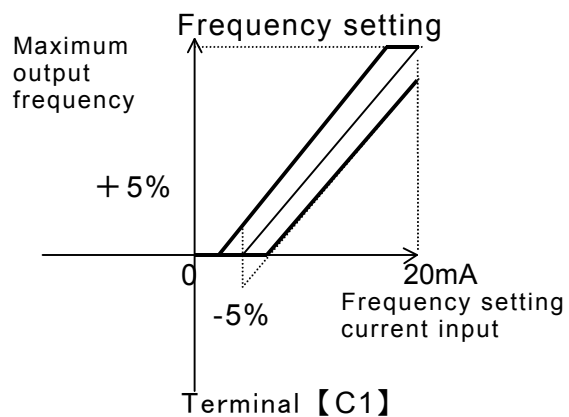
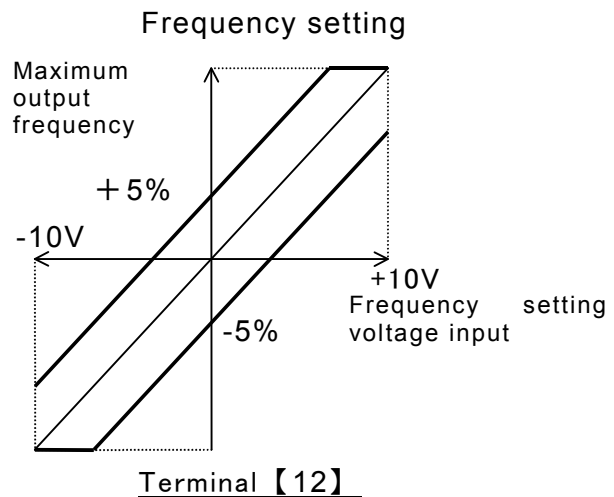

C33 *Analog setting signal filter*

- ◆ The analog signal supplied to control terminal 12 or C1 sometimes includes electric noise. Electric noise make the control unstable. Adjust the time constant of the input filter to remove the effects of electric noise.
Setting range: 0.00 to 5.00 s
- ◆ With a large time constant (setting), the control becomes stable but there is a delay in the control response. With a small time constant, the response is quick but the control becomes unstable.
If the setting is not clear, change the setting when the control is unstable or the response is slow.

Note) The function applies to both terminals [12] and [C1] (in common). However, when a PID feedback signal is input, H25 "PID control feedback filter" is applied.

P: Motor parameters

P01 Number of motor 1 poles

- ◆ This parameter is the number of poles of driven motor 1. Write a value to display correct motor speeds (synchronized speeds) at the LED.
Setting range: 2, 4, 6, 8, 10, 12 or 14

P02 Motor 1 (Capacity)

- ◆ A standard applicable motor capacity is set before shipment from the factory. Change the setting to drive a motor rated at other than the standard applicable motor capacity.
Setting range: 0.01 to 5.50 kW (3.7kW or smaller)
0.01 to 11.00kW (5.5, 7.5kW)

Set the standard applicable motor capacity specified in section 9-1 "Standard Specifications". The setting range should be between the rank higher by one rank or lower by two ranks from the standard applicable motor capacity. If the range is exceeded, accurate control may not be possible. If a value between the standard applicable motor capacity and the capacity of another rank is set, the data of the lower capacity is automatically written for the data of the related functions.

- ◆ After the setting of this function is changed, the settings of the following related functions change to the data for the Fuji's three-phase standard motor.
P03 "Motor 1 (Rated current)"
P06 "Motor 1 (No-load current)"
P07 "Motor 1 (%R1)"
P08 "Motor 1 (%X)"

Note) The settings of Fuji's three-phase standard motor are the data for 3-phase 200V or 400V / 50 Hz.

P03 Motor 1 (Rated current)

- ◆ This parameter is the rated current of motor 1.
Setting range: 0.00 to 99.9 A

P04 Motor 1 (Tuning)

- ◆ The motor data is measured and the data is automatically written.

Setting	State of operation
0	Inactive
1	The primary resistance (%R1) of the motor and the leakage reactance (%X) of the base frequency are measured while the motor is stopped, and the data is automatically written to P07 and P08.(Static tuning)
2	The primary resistance (%R1) of the motor and the leakage reactance (%X) of the base frequency are measured while the motor is stopped, then the no-load current (I _o) is measured while the motor turns , and P06, P07 and P08 are automatically written.(Dynamic tuning)

- ◆ Perform a tuning when the P06, P07 and P08 data written in the inverter in advance differs from the actual motor data, that is, in the following cases. Improvement in the control and calculation accuracy is expected.
 - When a motor other than the Fuji's standard three-phase motor (4 poles) is used.
 - When the impedance on the output side cannot be ignored due to a long wiring length between the inverter and the motor or connection of a reactor.
 - When %R1 or %X is unknown due to a nonstandard motor or a special motor.

Tuning procedure

1. Adjust the voltage and frequency according to the characteristics of the motor. Adjust "F03", "F04", "F05" and "F06".
2. Enter the motor constants which cannot be tuned. P02 "Capacity", P03 "Rated current", P06 "No-load current" (The no-load current is not necessary in Dynamic tuning.)
3. To tune the no-load current, too, disconnect the motor from the mechanical units and check that no danger occurs even if the motor turns.
4. Set P04 "Tuning" to "1" (motor stop) or "2" (motor rotation) and press the FUNC/DATA key to write the data, then issue an operation command (press the RUN key or turn the FWD or REV terminal on) to start tuning. Tuning takes several seconds to several tens of seconds. (When the setting is "2", the motor accelerates to a half of the base frequency in the set acceleration/deceleration time to tune the no-load current, then decelerates. Therefore the time necessary for tuning varies according to the set acceleration/deceleration time.)
5. During tuning, the set data ("1" or "2") blinks rapidly and, upon the end of tuning, the next function code (P05) is displayed. When the FWD or REV terminal is connected to start tuning, disconnect the terminal.

Note) Turn the BX and RST terminals off before starting tuning.

 WARNING	<ul style="list-style-type: none"> • If auto tuning is set at "2", the motor turns at a half of the base frequency. Make sure that the motor is disconnected from the mechanical units and that no danger results from the rotation. Otherwise injuries could occur.
---	---

P05 Motor 1 (Online tuning)

- ◆ The motor temperature changes after operation for a long time, changing the motor speed. Use online tuning to reduce the speed fluctuation caused by temperature changes of the motor.

Setting	State of operation
0	Inactive
1	Active

P06 Motor 1 (No-load current)

- ◆ This parameter is the no-load current (exciting current) of motor 1.
Setting range: 0.00 to 99.9 A

P07 Motor 1 (%R1 setting)**P08 Motor 1 (%X setting)**

- ◆ Write these parameters when a motor other than the Fuji's standard three-phase motor is used and the impedance between the inverter and motor and motor constant are already known.
- ◆ Calculate %R1 in the following formula.

$$\%R1 = \frac{R1 + \text{CableR}}{V / (\sqrt{3} \times I)} \times 100[\%]$$

where R1:

Resistance of primary coil of motor for single phase [ohm]

Cable R:

Resistance of output cable for single phase [ohm]

V:

Rated voltage [V]

I:

Rated motor current [A]

- ◆ Calculate %X in the following formula.

$$\% = \frac{X1 + X2 \times XM / (X2 + XM) + \text{CableX}}{V / (\sqrt{3} \times I)} \times 100[\%]$$

where

X1: Primary leakage reactance of motor [ohm]

X2: Secondary leakage reactance of motor
(conversion to primary value) [ohm]

XM: Motor excitation reactance [ohm]

Cable X: Reactance of output cable [ohm]

V: Rated voltage [V]

I: Rated motor current [A]

Note) Use the reactance effective at F04 "Base frequency 1".

- ◆ Add the value for a reactor and filter connected to the output circuit. If the cable value can be ignored, the cable value should be "0".

P09 Motor 1 (Slip compensation control 1)

- ◆ When the load torque changes, the motor slip changes and the motor speed fluctuates. With the slip compensation control, a frequency proportional to the motor torque is added to the output frequency of the inverter to minimize the fluctuation of the motor speed caused by torque changes.

Setting range: 0.00 to 15.00 Hz

- ◆ Calculate the slip compensation data in the following formula.

Slip compensation amount =

$$\text{Base frequency} \times \frac{\text{Slip [r / min]}}{\text{Synchronized speed [r / min]}} [\text{Hz}]$$

(Slip) = (Synchronized speed) - (Rated speed)

P10 Motor 1 (Slip compensation response time 1)

- ◆ Set the response time for slip compensation.
Note) With a small setting, the response time becomes shorter, but regeneration may cause overvoltage tripping with some loads. In this case, set this function to longer time.

H:High Performance Functions



H01 Total operation time













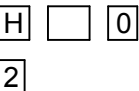

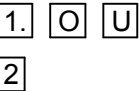
- ◆ The total power-on time of the inverter is displayed.

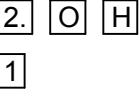
A number between 0 and 6500 is displayed, indicating 0 to 65000 hours. (The time is displayed in ten hours, though the inverter counts each hour. The time shorter than one hour is not counted.)

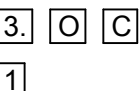
H02 Trip history

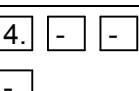
- ◆ A history of the latest four events of activation of protective functions is stored in memory. To call up each event, press the  key. Press the

 or  key to confirm the history.

	Procedure	Display example	Remarks
1	Call up   		
2	 ↓ 		The latest protective operation is displayed.
3	 ↓ 		The protective operation before the previous one is displayed.
4	 ↓ 		The protective operation before the two previous ones is displayed.
5	 ↓ 		The protective operation before the three previous ones is displayed.
6	 ↓ → 		

The new record of protective operation is stored in the latest protective operation memory, and the previous records are shifted one by one, and the record of protective operation before the four previous ones is deleted.

H03 Data initializing(Data reset)

- ◆ This function restores (initializes) the factory data over alterations made by the user.

Setting 0: Disabled

1: Initialize

Press the  and  keys simultaneously

to change the setting to "1", then press the  key to initialize the settings of all functions. After

initialization is completed, the setting automatically returns to "0".

H04 Auto-reset(Times)

H05 Auto-reset (Reset interval)

When the protective function of the inverter which starts the retry function is activated, operation of the inverter protective function is canceled to restart the inverter automatically instead of an alarm and output stop.

H04

- ◆ Set the number of resetting cycles of the protective function.

Setting range: 0 to 10 (0: retry inactive)

H05

- ◆ Set the wait time from activation of a protective function to resetting.

Setting range: 2 to 20 s

- ◆ Inverter protective functions for retry and start

OC1, OC2, OC3	Overcurrent
OU1, OU2, OU3	Overvoltage
OH1	Overheated heat sink
dbH	Overheated braking resistor
OL1	Overloaded motor 1
OL2	Overloaded motor 2
OLU	Overloaded inverter

- ◆ When the data of H04 Retry (Times) is set to 1 to 10, retry operation starts and the time set at H05 "Retry (Reset interval)" elapses, then an inverter start command is automatically input. If the cause of the alarm has been removed, the inverter starts without entering the alarm mode. If the cause of the alarm remains, the protective function is activated again to wait for the time set at H05 "Retry (Times)". If the cause of the alarm is not removed after the number of repetition cycles set at H04 "Retry (Reset interval)", the inverter enters the alarm mode.

 WARNING	If the retry function has been selected, the inverter may automatically restart according to some causes after tripping. (Design the machine so that human safety is ensured after restarting.) Otherwise an accident could occur.
---	--

■ Upon success of retry

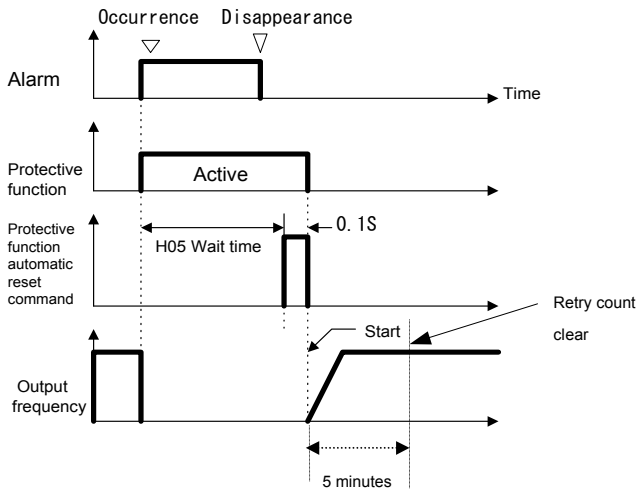

■ Upon failure of retry

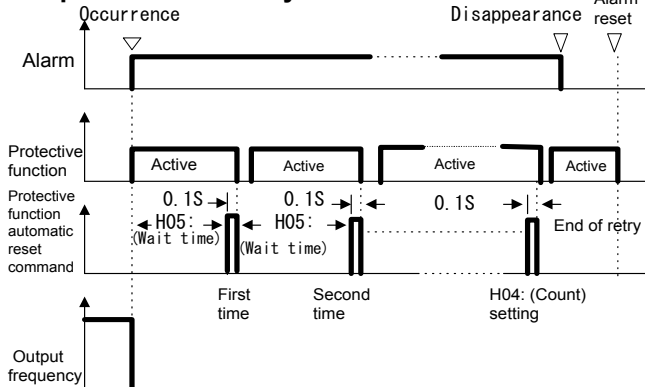

H06 Fan stop operation

- ◆ With this function, the temperature of the heat sink is detected while the inverter is turned on, to turn on or off the cooling fan automatically. If this function is not selected, the cooling fan rotates at any time.

Setting 0: No on/off control
1: On/off control

H07 ACC/DEC pattern (Mode select)

- ◆ Select the acceleration/deceleration mode.
Setting 0: Inactive (linear acceleration/deceleration)
1: S-curve acceleration/deceleration (Weak)
2: S-curve acceleration/deceleration (Strong)
3: Non-linear (for variable torque)

When the function is set at "1", "2" or "3", a change in the acceleration or deceleration time during acceleration or deceleration is not reflected immediately. The setting becomes effective after a constant speed is reached or the inverter is stopped.

【S-curve acceleration/deceleration】

To reduce the shock of the mechanical system, the change in the output frequency is made smooth when the frequency is set.

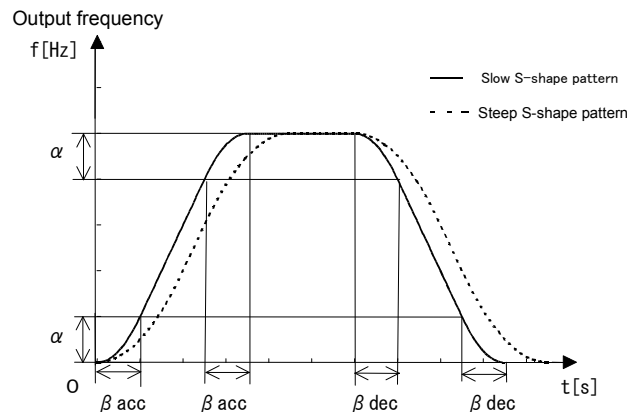

<Constant of each pattern>

	H07 = 1 (slow S-curve pattern)	H07 = 2 (steep S-curve pattern)
Range of S-curve (α)	0.05 x (Maximum output frequency [Hz])	0.10 x (Maximum output frequency [Hz])
S-curve time during acceleration (β_{acc})	0.10 x (Acceleration time [s])	0.20 x (Acceleration time [s])
S curve time during deceleration (β_{dec})	0.10 x (Deceleration time [s])	0.20 x (Deceleration time [s])

When the acceleration/deceleration time is extremely long or short, the result is linear acceleration/deceleration.

【Curved acceleration/deceleration】

Use this option to minimize the acceleration/deceleration time for an acceleration/deceleration pattern of the motor including the operation zone in the constant output range.

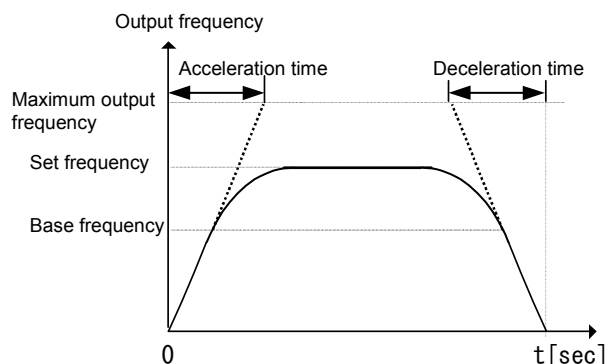

H09 Start mode (Rotating motor pickup)

- ◆ This function smoothly starts a motor coasting due to an external force or the like after momentary power failure. The speed of the motor is detected upon power recovery or restart and the same frequency as that for the motor speed is output. Therefore the motor starts smoothly without a shock. However, when the coasting speed of the motor converted in the inverter frequency exceeds 120 Hz, setting of F03 "Maximum frequency 1" or setting of F15 "Frequency limiter (High)", the regular starting method is adopted.

Setting	Regular starting	Restarting after momentary power failure
0	Inactive	Inactive
1	Inactive	Active
2	Active	Active

◆ Description of setting

- 1: This function is effective when the setting of F14 "Restart after momentary power failure (Operation selection)" is "2" or "3". Starting is made at the same frequency as that for the coasting speed.
- 2: Upon restart after momentary power failure, operation command ON and other starting methods, the speed of the coasting motor is detected and starting is made at the same frequency as that for the coasting speed.

Note) When this function is used, use the following setting to detect the accurate rotation speed of the motor.

When a motor other than the one made by Fuji Electric is used or when the wiring length is long, perform P04 Tuning.

H10 Energy-saving operation

- ◆ When the output frequency for a small load is constant (constant speed operation) and the setting of F09 "Torque boost 1" is other than "0", the output voltage is automatically lowered to minimize the product (power) of the voltage and the current.
Setting 0: Inactive
1: Active

Notes)

1. Use this function for fans, pumps or other square reduction torque loads. If this function is applied to a constant torque load or to an application with a rapidly changing load, there is a delay in the control response.
2. The energy-saving operation is automatically canceled to resume regular operation during acceleration or deceleration or when the torque limiter function is activated.

H11 Dec mode

- ◆ Select the stopping method of the inverter after a stop command.
Setting 0: Normal
(Deceleration to stop based on data of H07 "ACC/DEC pattern")
1: Coast-to-stop

Note) This function is not activated when the set frequency is lowered to stop. The function is activated only when a stop command is input.

H12 Instantaneous overcurrent limiting

- ◆ When the motor load abruptly changes to cause a current exceeding the protective level of the inverter to flow, the inverter trips due to the overcurrent. The Instantaneous overcurrent limiting function controls the inverter output within the protective level even upon an excessive load.
- ◆ The operation level of the Instantaneous overcurrent limiting cannot be adjusted. Use the torque limit function to set on output limitation.
- ◆ The torque generated by the motor may become low in a Instantaneous overcurrent limiting state. Therefore deactivate the momentary overcurrent limit function for applications such as the elevator where the torque generated by the motor must not be low. In this case, because the inverter trips due to an overcurrent when a current exceeding the protective level of the inverter flows, use forcible stopping measures by a mechanical brake or other protective measures.
Setting 0: Inactive
1: Active

H13 Auto-restart (Restart time)

- ◆ When the power supply to a running motor is shut off or power failure occurs and the power supply is quickly switched to another system, the phase of the voltage of the new system deviates from the phase of the voltage remaining in the motor and electrical or mechanical trouble may be developed. When switching the power supply system in a short time, write the time for attenuation of the remaining voltage from the motor after power shutoff. The setting is effective during restart after momentary power failure.
Setting range: 0.1 to 5.0 s
If the duration of momentary power failure is shorter than the wait time data, restart is made after this time. If the duration of momentary power failure is longer than the wait time data, restart is made after completion of operation preparation of the inverter (about 0.2 to 0.5 s).

H14 Auto-restart(Frequency fall rate)

- ◆ This function determines the drop ratio of the output frequency for the synchronization between the output frequency of the inverter and the motor speed, that is, the speed of synchronization. This function is also used to drop the frequency as a stall prevention function for an excessive load during regular operation.
Setting range: 0.00, 0.01 to 100.0 Hz/s
Set "0.00" to drop according to the currently selected deceleration time.

Note) A large frequency drop ratio may cause temporary increase in the regeneration energy from the load, activating the overvoltage protection function. On the contrary, a small frequency drop ratio may cause long operation time of the current limit function, activating the inverter overload protection function.

H20 PID control (Mode select)

to

H25 PID control (Feedback filter)

- ◆ The PID control detects a control amount (feedback value) from the sensor of the controlled object and compares it with the reference value (set temperature, etc.). Upon difference between them, an action is taken to reduce the difference. That is, this control method makes the feedback value become consistent with the reference value. This method can be applied to flow control, pressure control, temperature control and other process controls.

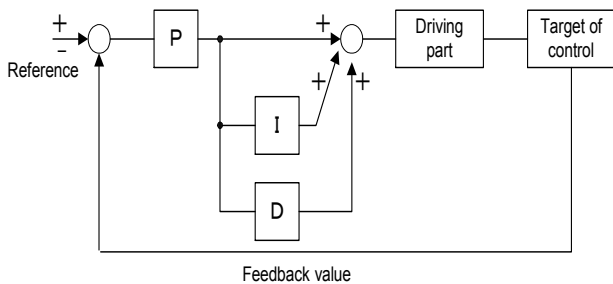

- ◆ Because forward and reverse operation can be selected for the output of the PID controller, the rpm of the motor can be increased or decreased in relation to the output of the PID controller.

H20

- Setting 0: Inactive
- 1: Normal operation
- 2: Inverse operation

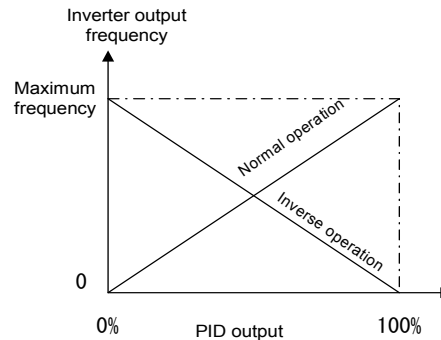

- ◆ The reference value can be given at F01 "Frequency command 1" or directly input from the keypad panel. Select an arbitrary terminal from E01 "X1 terminal (Function selection)" through E05 "X5 (Function selection)", and set data "9" (frequency command 2 / frequency command 1). To obtain the reference value from F01 "Frequency command 1", input an OFF signal to the selected terminal. When inputting directly from the keypad panel, turn the selected terminal on.
- ◆ The process amount of the reference value and feedback value can be displayed based on the setting at E40 "Display coefficient A" and E41 "Display coefficient B".

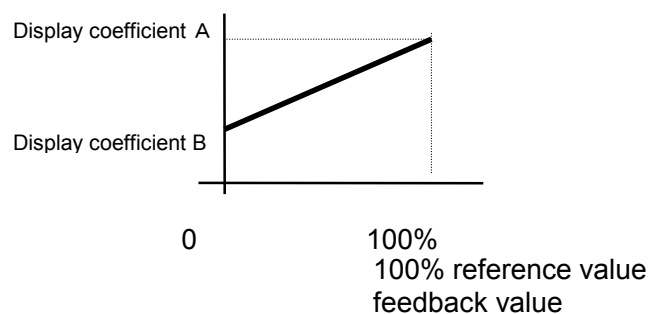

H21 PID control (Feedback signal)

- Select the feedback value input terminal and electrical specification of the terminal. Select one from the table below according to the specifications of the sensor.

Setting	Selection item
0	Control terminal 12, normal operation (voltage input 0 to +10V)
1	Control terminal C1, normal operation (current input 4 to 20 mA)
2	Control terminal 12, inverse operation (voltage input +10 to 0V)
3	Control terminal C1, inverse operation (current input 20 to 4 mA)

Note) The feedback value of the PID control can be input only in the positive polarity. The negative polarity (0 to -10 Vdc, -10 to 0 Vdc, etc.) cannot be input. Therefore the control cannot be applied to reversible operation using the analog signal.

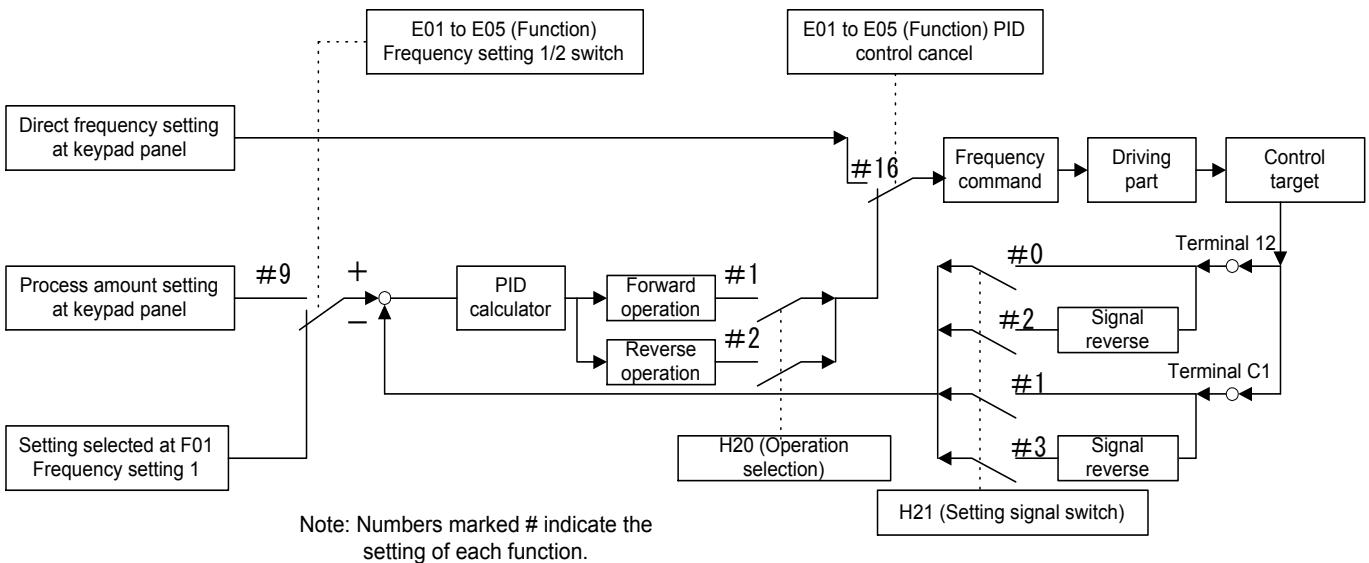
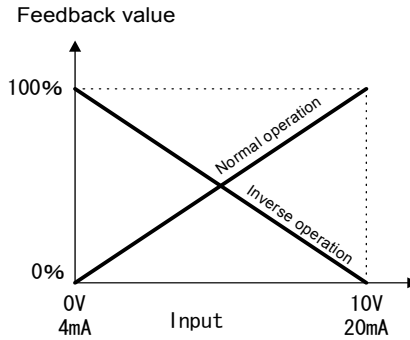

H22 PID control (P (P gain))

- Generally speaking, P: gain, I: integral time and D: differential time are not used alone. Functions are combined like: P control, PI control, PD control and PID control.

◆ P action

An operation where there is proportional relationship between the amount of operation (output frequency) and deviation is called P operation. Therefore the P action outputs an operation amount proportional to the deviation. However, the deviation cannot be eliminated by only the P action.

Setting range: 0.01 to 10.00 times

- The P gain is a parameter which determines the degree of response to the deviation of P action. With a large gain, the response is quick but hunting is likely to occur. With a small gain, the response is stable but slow.

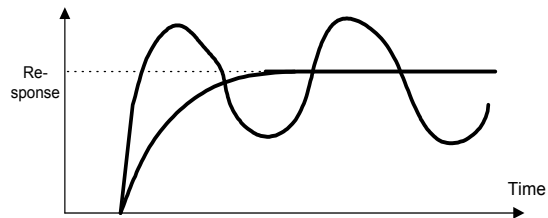
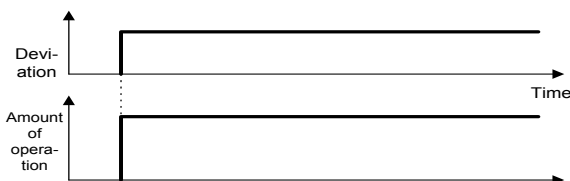

H23 PID control (I (integral time))

◆ I action

An operation where the speed of the change in the amount of operation is proportional to the deviation is called I action. Therefore the I action outputs an operation amount obtained from integration of the deviation. For this reason, the I action is effective to converge the control amount to the reference value. However, response is slow to the deviation with abrupt changes.

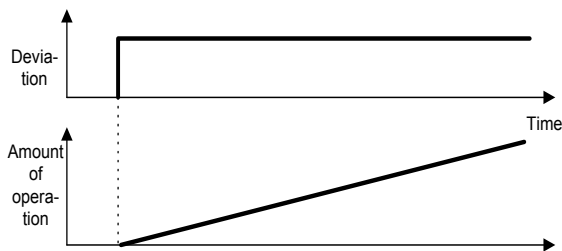

Setting range: 0.0 Inactive, 0.1 to 3600 s
To determine the effect of the I action, I: integral time is used as a parameter. With a long integral time, the response is slow and reaction to an external force is small. With a small integral time, the response is quick. When the integral time is too small, there is hunting.

H24 PID control (D (Differential time))

◆ D action

An operation where the amount of operation is proportional to the differential value of the deviation is called D action. Therefore, the D action outputs an operation amount obtained from the differentiation of the deviation and the response to abrupt changes is quick.

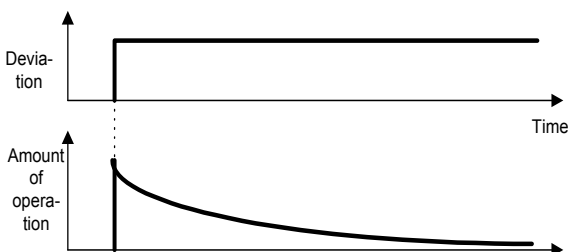

Setting range: 0.00 Inactive, 0.01 to 10.0 s
D: differential time is used as a parameter to determine the effect of the D action. With a long differential time, decrease in the vibration caused by the P action upon deviation is quick. With too large a differential time, vibration may become larger. With a small differential time, decrease in the deviation becomes smaller.

◆ PI control

Deviation remains with P action only. To eliminate the remaining deviation, I action is added and P + I control is generally adopted. The PI control functions to always eliminate deviation in spite of changes in the reference value and stationary disturbances. However, when the I action is strong, response to the deviation with abrupt changes is slow.

P action only can be used for loads with an integral factor.

◆ PD control

Upon deviation, the PD control generates an operation amount larger than that obtained by D action only, to reduce the increase of the deviation. When deviation is reduced to small, the function of the P action is made smaller.

For a load including integral factors to be controlled, the P action alone can cause hunting in the response due to the action of the integral factors. The PD control is used in such cases to decrease hunting of the P action to stabilize. That is, this control method is applied to loads having no braking in the process itself.

◆ PID control

The function of the I action to reduce the deviation and the function of the D action to suppress hunting are combined with the P action. Accurate responses without deviation are obtained.

This control method is effective to loads which take time from generation of deviation to development of a response.

H25 PID control (Feedback filter)

◆ This function provides a filter for the feedback signal input at control terminal 12 or C1. The filter makes the operation of the PID control system stable. However, an excessively large setting causes a poor response.

Setting range: 0.0 to 60.0 s

H26 PTC thermistor (Mode select)

- ◆ Select this function for a motor equipped with a PTC thermistor for overheat protection.

Setting 0: Inactive
1: Active

Connect the PTC thermistor as shown in the figure. The protective operation is common with the external alarm input. Therefore the protective function operates at the "external alarm".

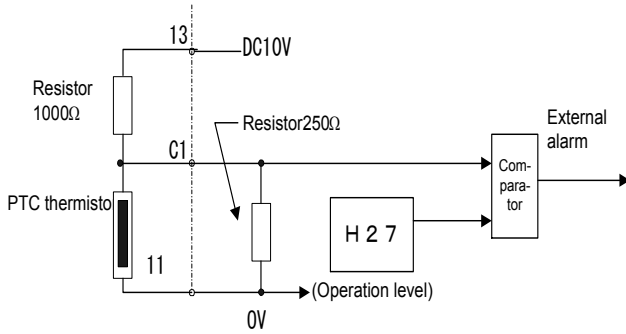

H27 PTC thermistor (Level)

- ◆ The voltage input at terminal [C1] is compared with the set voltage and, when the input voltage at terminal [C1] is larger than the set voltage (operation level), H26 "PTC thermistor (Operation selection)" is activated.

Setting range: 0.00 to 5.00 V
(The setting smaller than 0.10 is handled as 0.10.)

- ◆ The alarm temperature is determined by the PTC thermistor and the internal resistance of the PTC thermistor changes largely at the alarm temperature. Set the operation (voltage) level using this change of resistance.

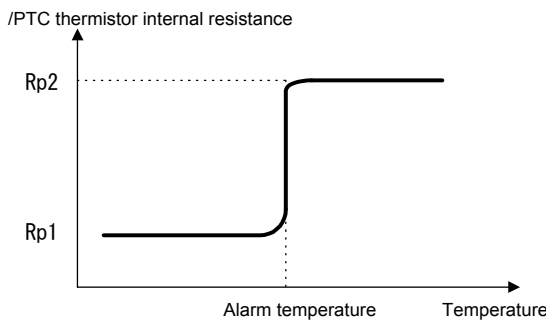

From the figure of H26 "PTC thermistor (Operation selection)", the 250-ohm resistor and the PTC thermistor (resistance Rp) configure a parallel circuit. Therefore voltage VC1 (operation level) of terminal [C1] is calculated in the following equation.

$$V_{C1} = \frac{250 \cdot R_p}{1000 + \frac{250 \cdot R_p}{250 + R_p}} \times 10 \quad [V]$$

The operation level can be set when RP of the VC1 calculation equation is in the following

range.

$$R_{P1} < R_P < R_{P2}$$

To determine RP simply, calculate the following equation.

$$R_p = \frac{R_{p1} + R_{p2}}{2} \quad [\Omega]$$

H28 Droop operation

- ◆ To drive one machine with two or more motors, a larger load is exerted on the motor with a larger speed. The droop control attributes drooping characteristics to the speed during load fluctuation to balance the load.

- ◆ The drooping amount is calculated in the following formula.

Drooping amount = Base frequency

$$\times \frac{\text{Drooping content of speed at rated torque [r/min]}}{\text{Synchronized speed [r/min]}} \quad [Hz]$$

Setting range: - 9.9 Hz to 0.0 Hz

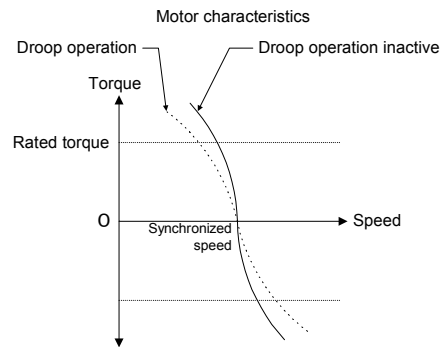

H30 Serial link (Function select)

- ◆ RS485 (standard accessory) can be connected as a link function (communication function).

- ◆ As a link function, the following items are possible.

- 1) Monitoring (monitoring of various data, confirmation of function code data)
- 2) Frequency setting
- 3) Operation command (FWD, REV and other commands set for digital input)
- 4) Function code data writing

Setting range: 0 to 3

The validity of communication can be switched by a digital input. Set the link functions available through communications.

Setting	Frequency setting	Operation command
0	Invalid	Invalid
1	Valid	Invalid
2	Invalid	Valid
3	Valid	Valid

The monitor function and function code data writing function are always valid. When the communication is disabled by means of a digital input, a state similar to setting "0" is obtained.

H31 RS485 (address)

to

H39 RS485 (Response interval)

◆ Set the various conditions of RS485 communication. Set according to the specifications of the host unit. Refer to section 9-4 for protocol and other specifications.

H31

◆ Set the station address of RS485.
Setting range: 1 to 31

H32 RS485 (Mode select on no response error)

◆ Set the communication error handling process and the error handling timer value.
Setting range: 0 to 3

Setting	Communication error handling process
0	Immediate Er 8 trip (coast to stop)
1	Operation continues until the timer time elapses, then Er 8 trip.
2	Operation continues and retry is made until the timer time elapses, then Er 8 trip upon a communication error or continuation of operation upon no communication error.
3	Operation continues.

H33 RS485 (Timer)

◆ Set the error handling timer value.
Setting range: 0.0 to 60.0 s

H34 RS485 (Baud rate)

◆ Set the transmission speed.

Setting	Transmission speed
0	1 9 2 0 0 bit/s
1	9 6 0 0 bit/s
2	4 8 0 0 bit/s
3	2 4 0 0 bit/s
4	1 2 0 0 bit/s

H35 RS485 (Data length)

◆ Set the data length.

Setting	Data length
0	8 bits
1	7 bits

H36 RS485 (Parity check)

◆ Set the parity bit.

Setting	Parity bit
0	None
1	Even
2	Odd

H37 RS485 (Stop bits)

◆ Set the stop bit.

Setting	Stop bit
0	2bits
1	1bit

H38 RS485 (No response error detection time)

◆ In a system where there is always an access to the station at certain intervals, no access caused by broken wire or other errors is detected and the inverter trips in Er8.

Setting range: 0 to 60 s
0: No detection

H39 RS485 (Response interval)

◆ Set the time taken until a response is sent back to the host unit upon a request.

Setting range: 0.00 to 1.00 s

H40 *Maximum temperature of heat sink*

- ◆ The maximum value in each hour is displayed in degree C.

H41 *Maximum effective current*

- ◆ The maximum value in each hour is displayed in A.

H42 *Main circuit capacitor life*

- ◆ The capacity of the capacitor in the main circuit is displayed in %. For the measuring conditions, refer to section 8-2 (1) "Measurement of capacitance of capacitor in main circuit".

H43 *Cooling fan operation time*

- ◆ Integral hours is displayed. The displayed time is 0 to 6500, indicating 0 to 65000 hours. (Though the displayed value is in ten hours, the inverter adds each hour. Operation shorter than one hour is not counted.)

H44 *Inverter ROM version*

- ◆ The version of the software of the inverter is displayed.

H45 *Keypad panel ROM version*

- ◆ The version of the software of the keypad panel is displayed.

H46 *Option ROM version*

- ◆ For inverters with optional equipment, the version of the optional software is displayed.

A: Alternative motor parameters**A01** *Maximum frequency 2*

The maximum frequency output by the inverter for motor 2. This parameter functions in the same way as F03 "Maximum output frequency 1". For the description, refer to F03 "Maximum output frequency 1".

A02 *Base frequency 2*

The maximum output frequency in the constant torque zone of motor 2, that is, the output frequency at the rated output voltage. This parameter functions in the same way as F04 "Base frequency 1". For the description, refer to F04 "Base frequency 1".

A03 *Rated voltage 2 (at base frequency 2)*

The rated output voltage supplied to motor 2. This parameter functions in the same way as F04 "Rated voltage 1". For the description, refer to F05 "Rated voltage 1".

A04 *Maximum voltage 2 (at maximum frequency 2)*

The maximum output voltage of the inverter for motor 2. This parameter functions in the same way as F06 "Maximum voltage 1". For the description, refer to F06 "Maximum voltage 1".

A05 *Torque boost 2*

The torque boost function of motor 2. This parameter functions in the same way as F09 "Torque boost 1". For the description, refer to F09 "Torque boost 1".

A06 *Electronic thermal overload relay for motor 2 (Select)***A07** *Electronic thermal overload relay for motor 2 (Level)***A08** *Electronic thermal overload relay for motor 2 (Thermal time constant)*

The electronic thermal overload relay functions of motor 2. These parameters function in the same way as F10 through F12 Electronic thermal overload relay for motor 1. For the description, refer to F10 through F12.

A09 *Torque vector control 2*

The torque vector function of motor 2. This parameter functions in the same way as F42 "Torque vector control 1". For the description, refer to F42 "Torque vector control 1".

A10 *Number of motor 2 poles*

The number of poles of driven motor 2. This parameter functions in the same way as P01 "Number of motor 1 poles". For the description, refer to P01 "Number of motor 1 poles)".

A11 Motor 2 (Capacity)

The capacity of motor 2. This parameter functions in the same way as P02 "Motor 1 (Capacity)". For the description, refer to P02 "Motor 1 (Capacity)". However, the function of related motor data changes to A12 "Motor 2 (Rated current)", A15 "Motor 2 (No-load current)", A16 "Motor 2 (%R1 setting)" and A17 "Motor 2 (%X setting)".

A12 Motor 2 (Rated current)

The rated current of motor 2. This parameter functions in the same way as P03 "Motor 1 (Rated current)". For the description, refer to P03 "Motor 1 (Rated current)".

A13 Motor 2 (Tuning)

Tuning of motor 2. This parameter functions in the same way as P04 "Motor 1 (Tuning)". For the description, refer to P04 "Motor 1 (Tuning)".

A14 Motor 2 (Online turning)

Online tuning of motor 2. This parameter functions in the same way as P05 "Motor 1 (Online tuning)". For the description, refer to P05 "Motor 1 (Online turning)".

A15 Motor 2 (No-load current)

The no-load current of motor 2. This parameter functions in the same way as P06 "Motor 1 (No-load current)". For the description, refer to P06 "Motor 1 (No-load current)".

A16 Motor 2 (%R1 setting)**A17 Motor 2 (%X setting)**

%R1 and %X of motor 2. These parameters function in the same way as P07 "Motor 1 (%R1 setting)" and P08 "Motor 1 (%X setting)". For the description, refer to P07 and P08.

A18 Motor 2 (Slip compensation control 2)

The slip compensation control of motor 2. This parameter functions in the same way as P09 "Motor 1 (Slip compensation control 1)". For the description, refer to P09 "Motor 1 (Slip compensation control 1)".

A19 Motor 2 (Slip compensation response time 2)

Set the response time for slip compensation of motor 2. This parameter functions in the same way as P10 "Motor 1 (Slip compensation response time)". For the description, refer to P10 "Motor 1 (Slip compensation response time)".

o: Optional functions**o00 Option selection**

0: Option inactive

1: Option active

Set 0 when option card is used.

Refer to the instruction manual of option card for detail of optional functions.

6. Protective Operation

6-1 List of Protective Operations

When an error occurs to the inverter, a protective function is activated to trip the inverter immediately, displaying the name of the alarm at the LED and allowing the motor to coast to stop.

Table 6-1-1 List of alarm display and protective operations

Name of alarm	Display	Description of operation	
Overcurrent protection	OC1	During acceleration	The protective function is activated when an overcurrent flowing in the motor or a short circuit or ground fault in the output circuit causes the instantaneous inverter output current to exceed the overcurrent detection level.
	OC2	During deceleration	
	OC3	During constant speed operation	
Overvoltage protection	OU1	During acceleration	The protective function is activated when the regenerative power from the motor increases to cause the DC link voltage of the main circuit to exceed the overvoltage detection level (Approx. 400 Vdc for 200V class, Approx. 800V for 400V class). When an excessive voltage is added to the source voltage, the inverter trips due to the overvoltage, but inverter protection against the overvoltage is impossible.
	OU2	During deceleration	
	OU3	During constant speed operation	
Undervoltage protection	LU	The protective function is activated when the source voltage drops to cause the DC link voltage in the main circuit to become lower than the undervoltage detection level (Approx. 200 Vdc for 200V class, Approx. 400V for 400V class). If F14 Restart after momentary power failure has been selected, no alarm display is given. If the voltage drops below the control power maintenance level, no alarm is displayed.	
Input phase loss protection	Lin	When the inverter is operated while one of the three phases of the power supply connected to the main power supply input terminals L1/R, L2/S and L3/T of the main circuit is missing or there is an unbalance among the three-phase voltages, the rectifying diode or smoothing capacitor of the main circuit may be broken. The inverter is stopped upon an alarm in these cases.	
Heat sink overheat	OH1	The protective function is activated when the temperature of the heat sink of the inverter is high because of a broken cooling fan or for other reasons.	
External alarm input	OH2	The protective function is activated by a contact signal from an alarm contact of the external device such as the braking unit, braking resistor, and external thermal overload relay connected to the control circuit terminal (THR). Or an overheat protective function is activated by the PTC thermistor.	
Braking resistor overheat	dbH	If the electronic thermal overload relay (for braking resistor) has been selected for function code F13, the protective function is activated upon a high operation frequency of the braking resistor to prevent the resistor from being burned due to the temperature rise.	
Motor 1 overload	OL1	If electronic thermal overload relay 1 has been selected for function code F10, the protective function is activated by a motor current exceeding the set operation level.	
Motor 2 overload	OL2	If motor 2 has been selected and driven and electronic thermal overload relay 2 has been selected for function code A06, the protective function is activated by the current in motor 2 exceeding the set operation level.	
Inverter overload	OLU	The protective function is activated by an output current exceeding the overload current rating to protect the semiconductor elements in the main circuit of the inverter from high temperatures.	
Memory error	Er1	The protective function is activated by a data writing error or other errors in the memory.	
Keypad panel communication error	Er2	The protective function is activated when a data transmission error or transmission stoppage is detected between the keypad panel and the control section in the keypad panel operation mode.	
CPU error	Er3	The protective function is activated by electric noise or other errors developed in the CPU, or if P24 is overloaded.	
Option error	Er4 Er5	Error during operation of option	
Output phase loss	Er7	The protective function is activated during auto tuning when there is a broken wire or no connection in the inverter output circuit.	
RS485 communication error	Er8	The protective function is activated when a communication error occurs during communication through RS485.	

6-2 Alarm Reset

When the inverter trips, remove the cause then press the PRG/RESET key on the keypad panel or input a reset command from the RST control terminal to reset the tripping state. Because the reset command is activated by an edge, supply the command in an OFF - ON - OFF sequence as shown in Fig. 6-2-1. When resetting the tripping state, deactivate the operation command. If the operation command is left turned on, the inverter starts operation immediately after the error is reset.

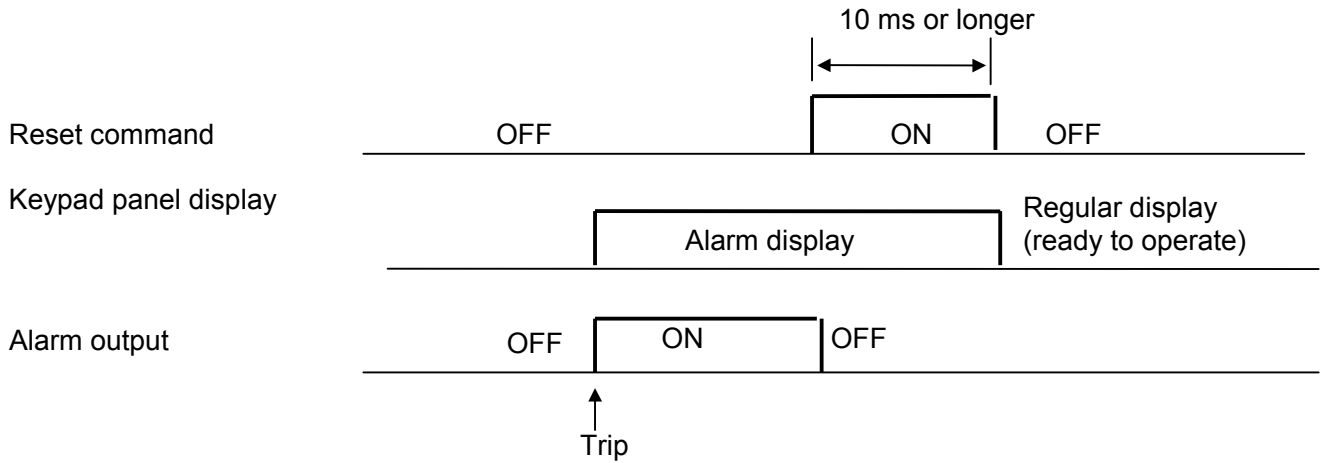

Figure 6-2-1



WARNING

If an alarm reset is made with the operation signal turned on, a sudden start will occur. Check that the operation signal is turned off in advance.
Otherwise an accident could occur.

7. Troubleshooting

7-1 When Protective Function Goes Active

(1) Overcurrent

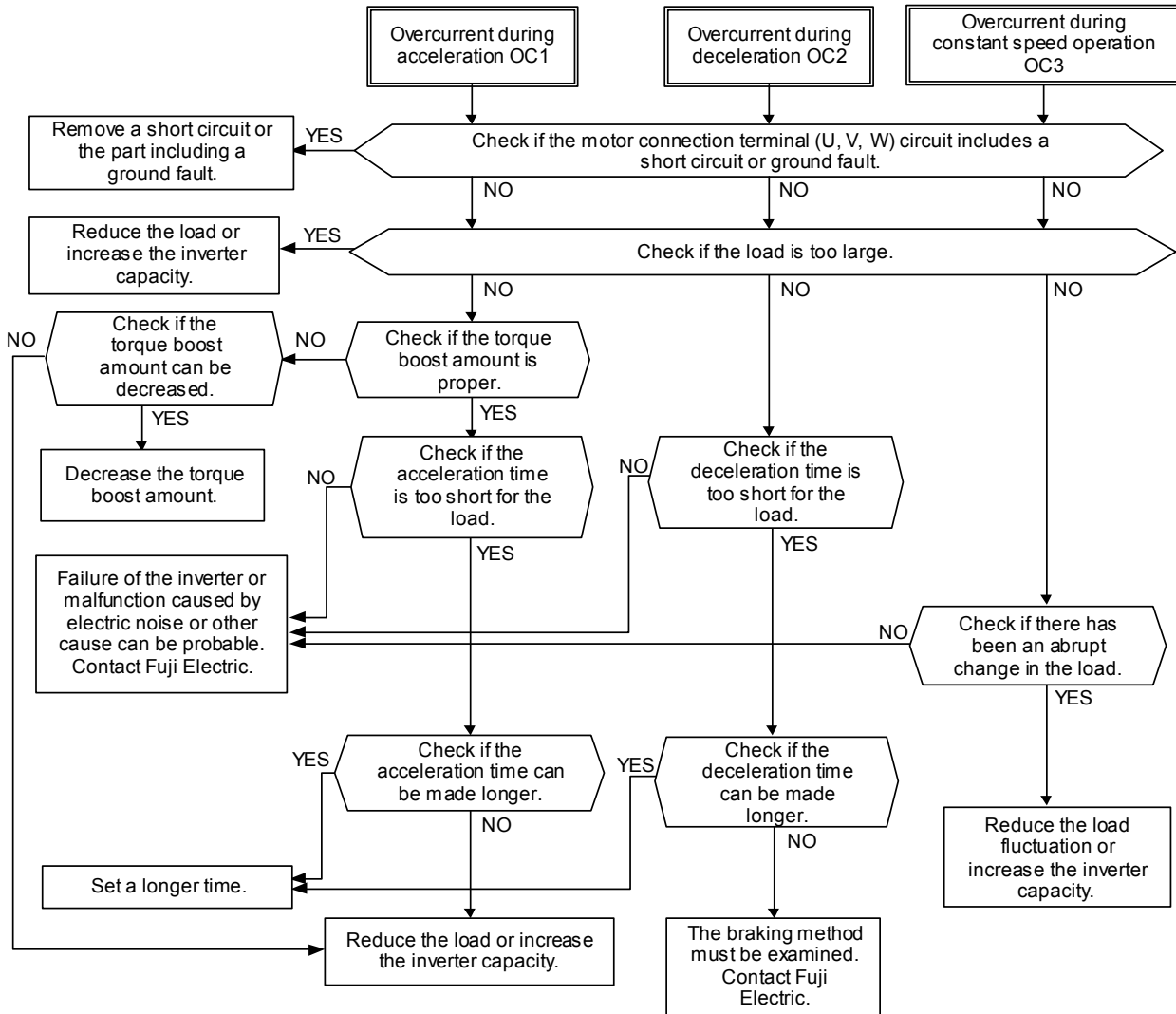

(2) Overvoltage

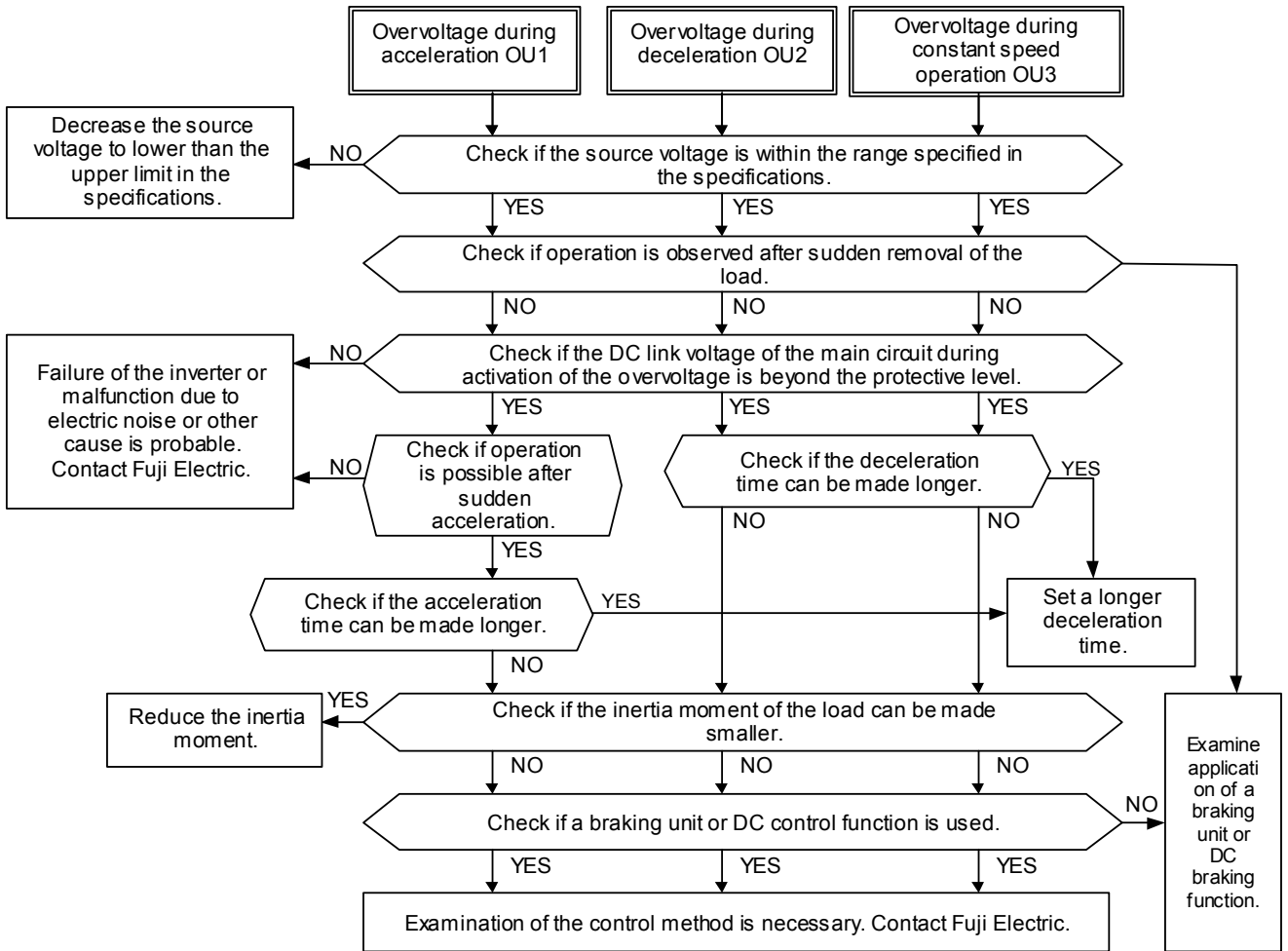

(3) Undervoltage

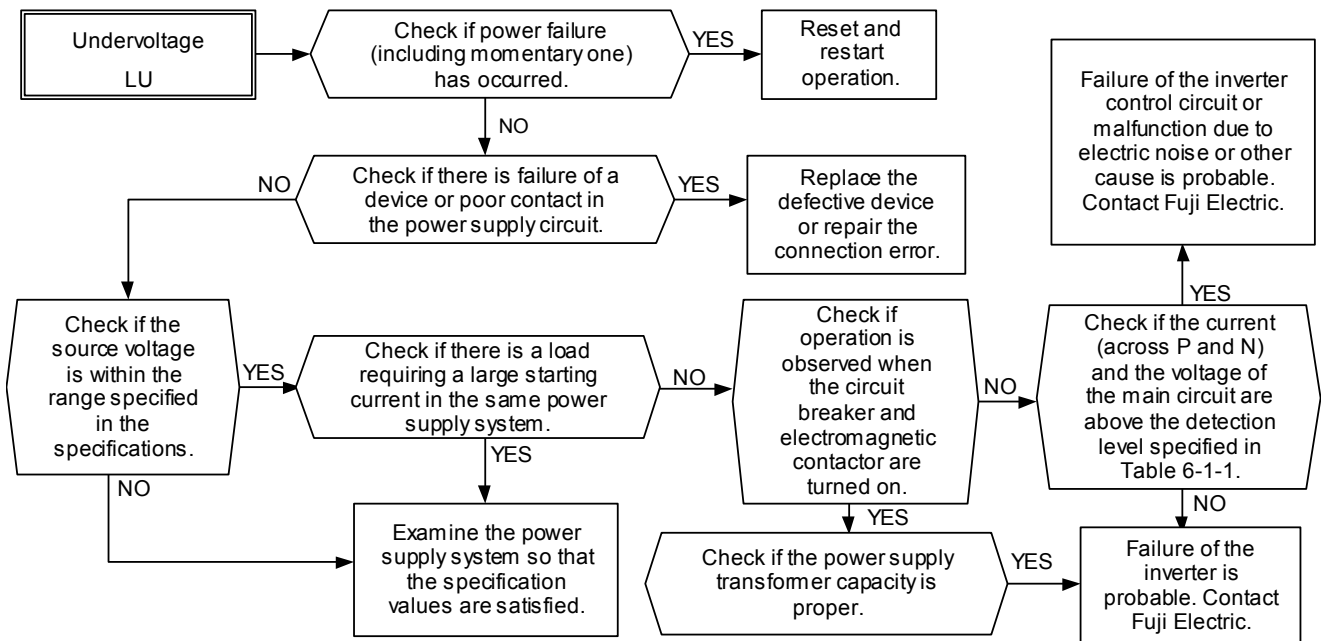

(4) Inverter inside overheat or heat sink overheat

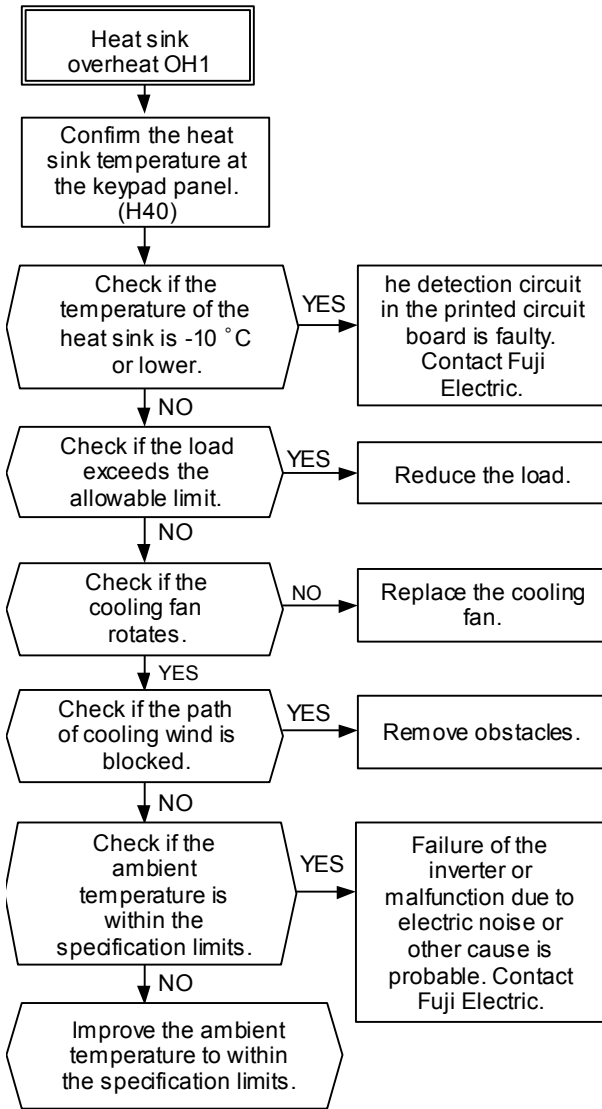

(5) External alarm input

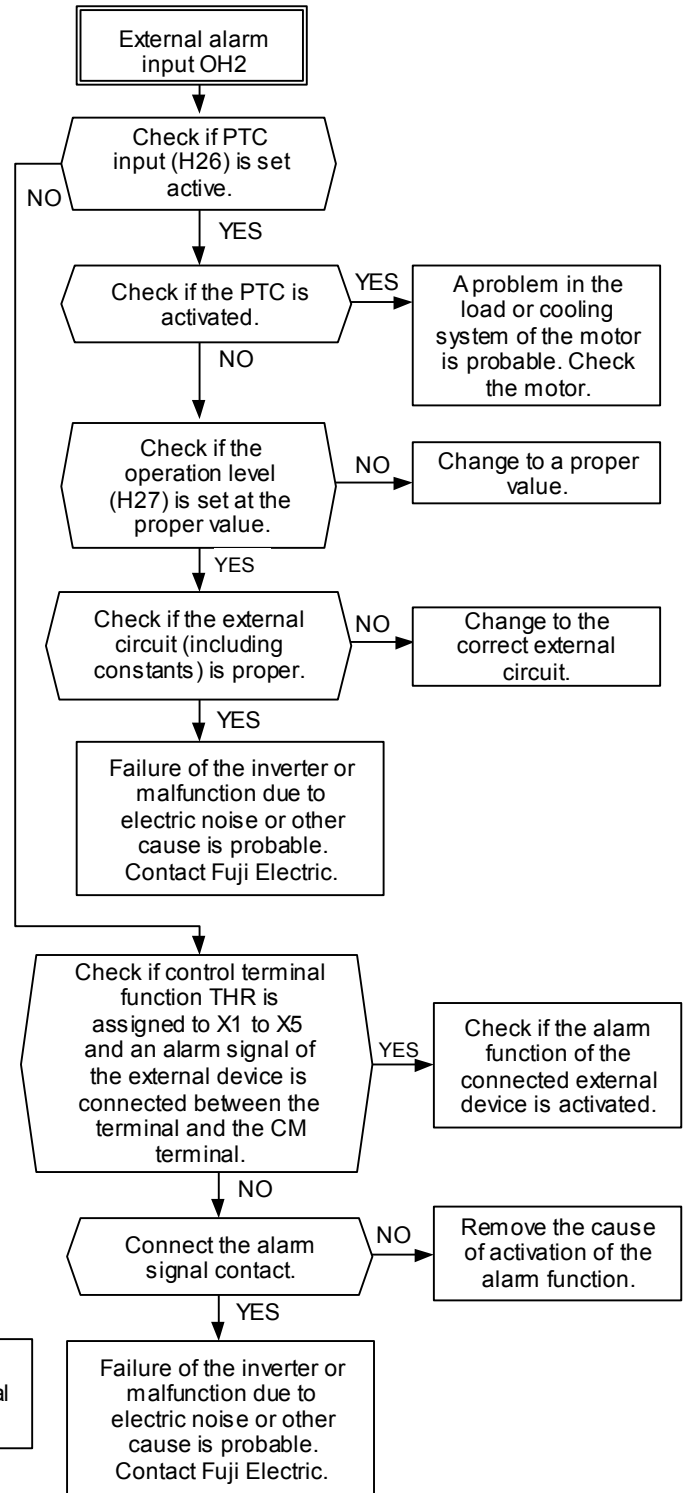

(6) Inverter overload, motor overload

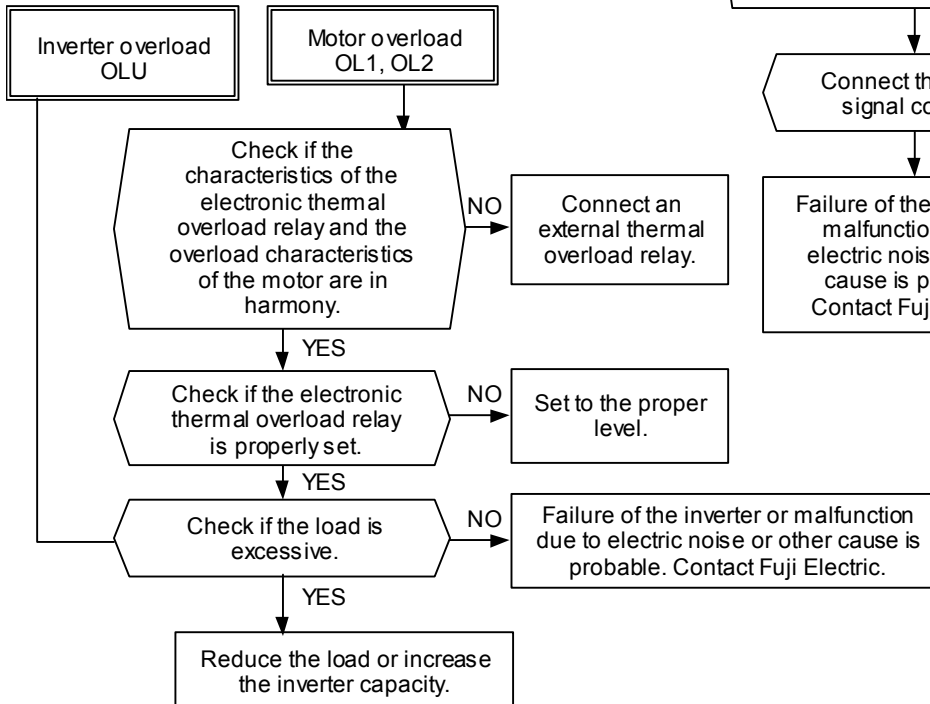

(7) Memory error Er1, keypad panel communication error Er2, CPU error Er3

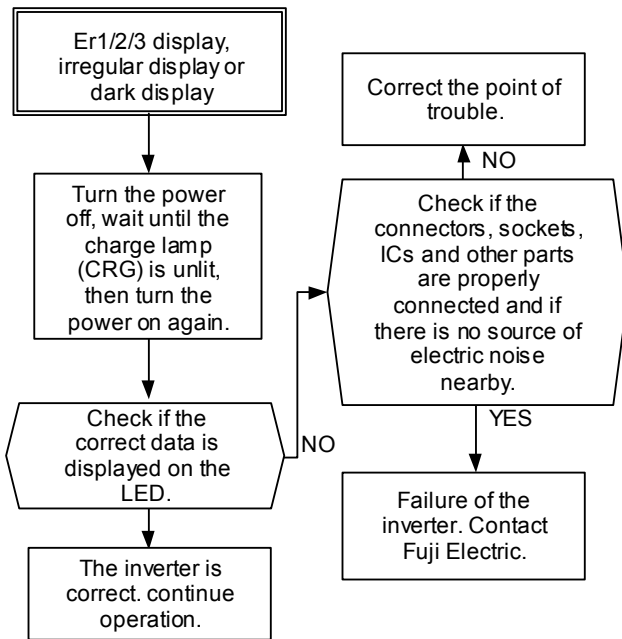

(8) Output wiring error

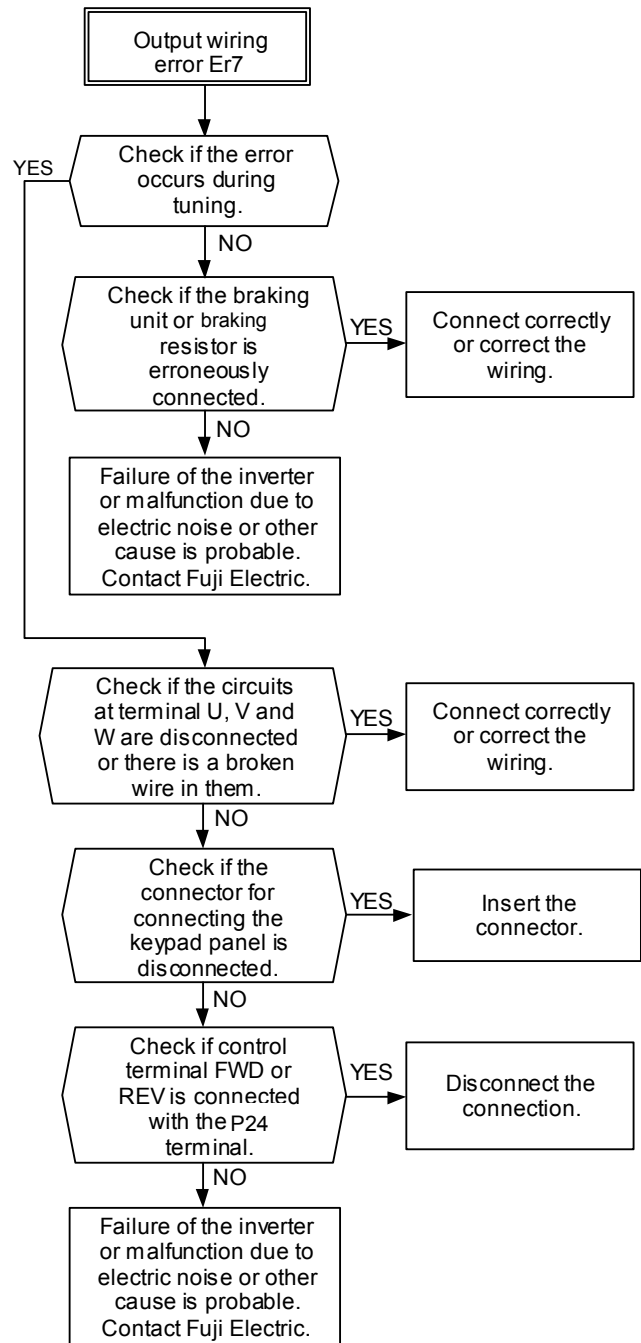

(9) Input phase loss

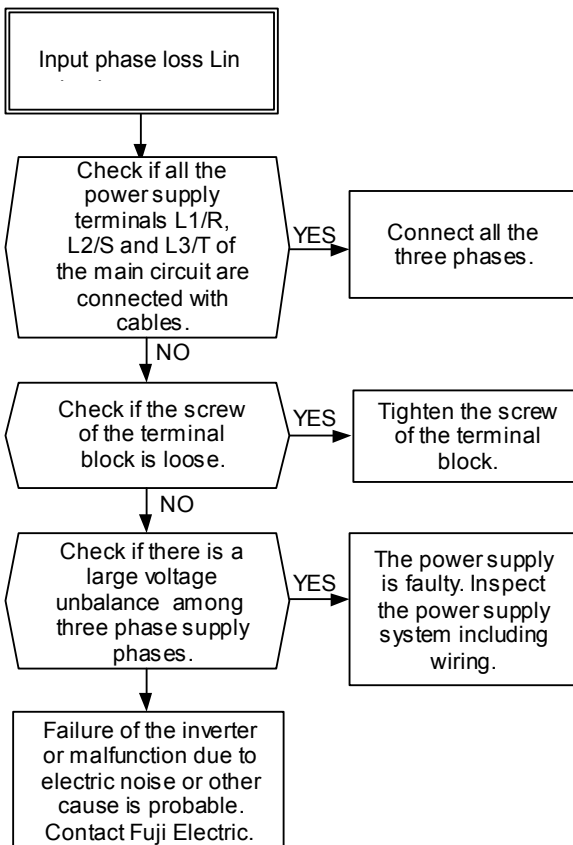

7-2 When Motor rotates Incorrectly

(1) The motor does not rotate.

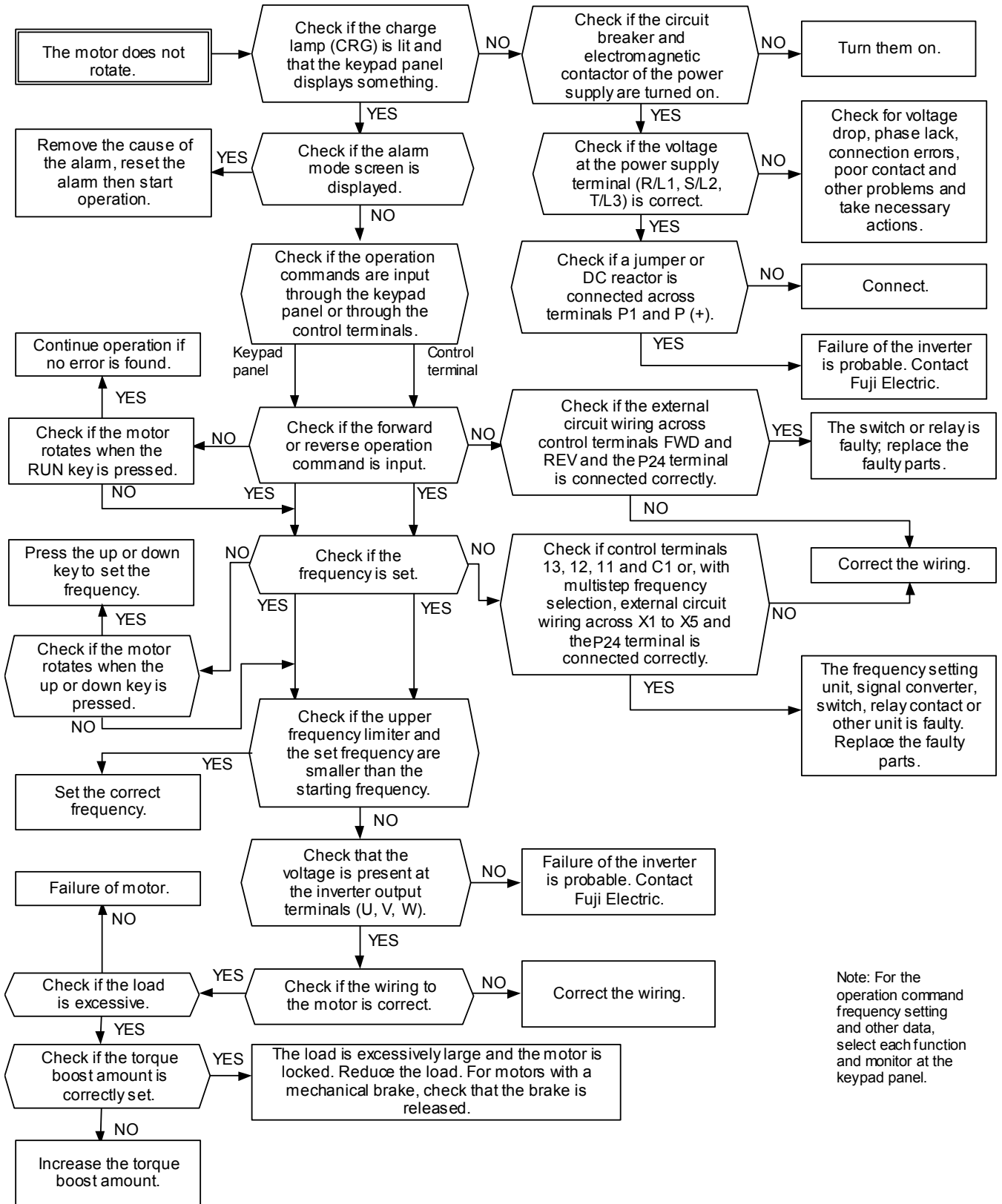

Note: For the operation command frequency setting and other data, select each function and monitor at the keypad panel.

The motor does not start when a coast-to-stop command or DC braking command is being input.

(2) The motor rotates but the speed does not change.

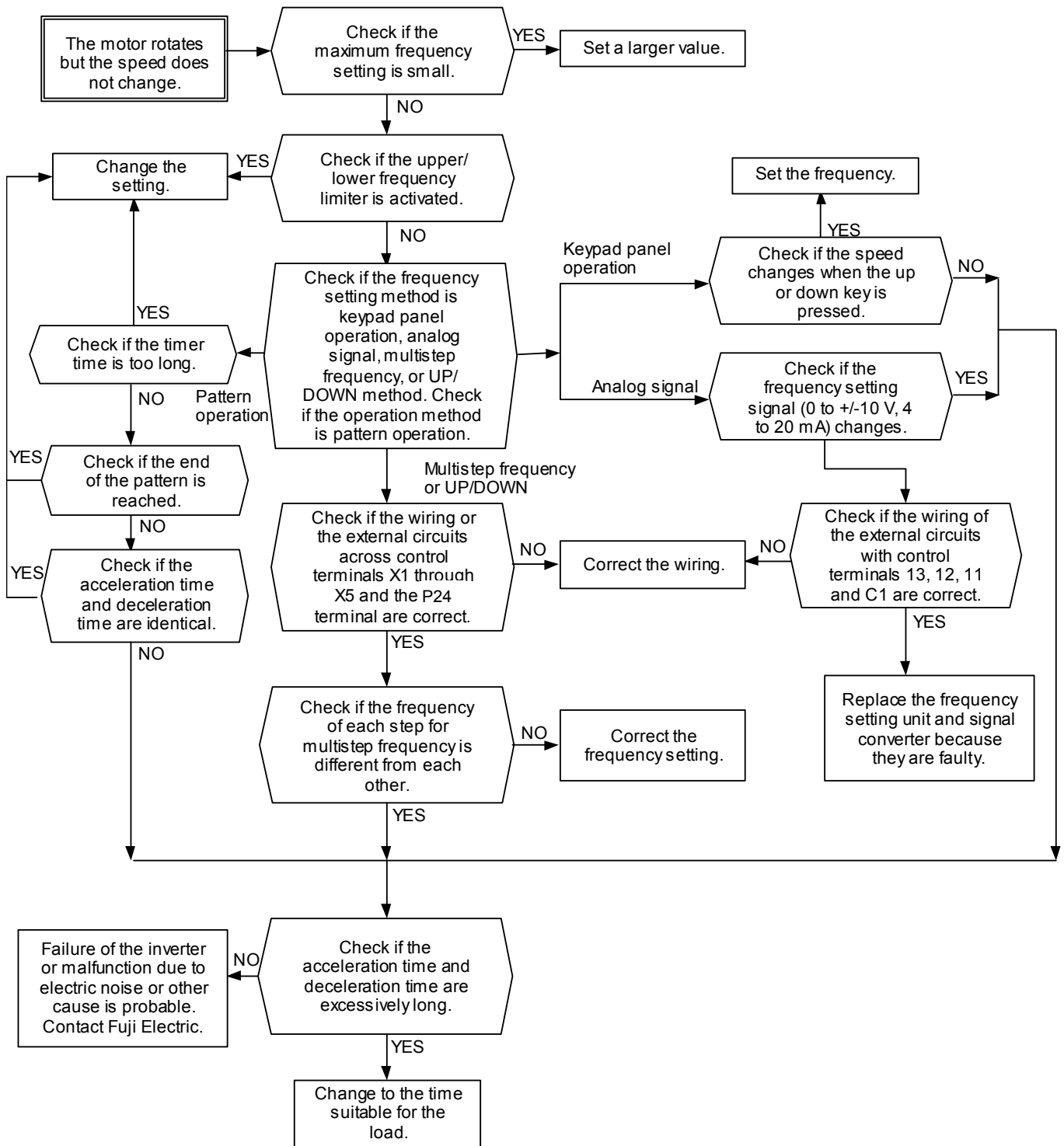

The change in the rotation speed of the motor is also small in the following cases.

- " F01 "Frequency command 1" and C30 "Frequency command 2" are set at "3" and a signal is input from both of control terminals 12 and C1, and there is no change in the sum of them.
- The load is excessively large and the torque limit and current limit functions are activated.

(3) The motor loses speed during acceleration.

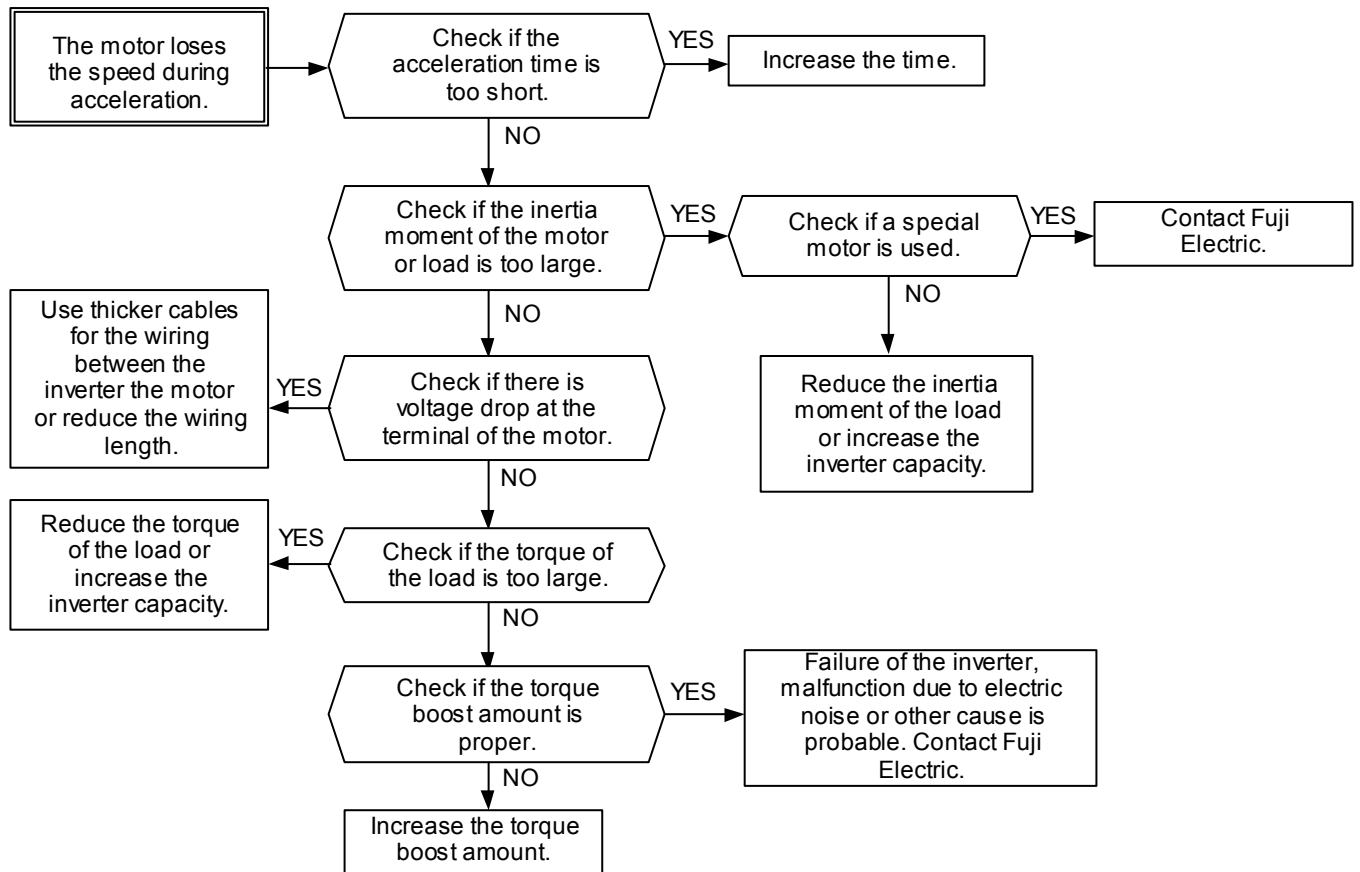

(4) Excessive heat generation from motor

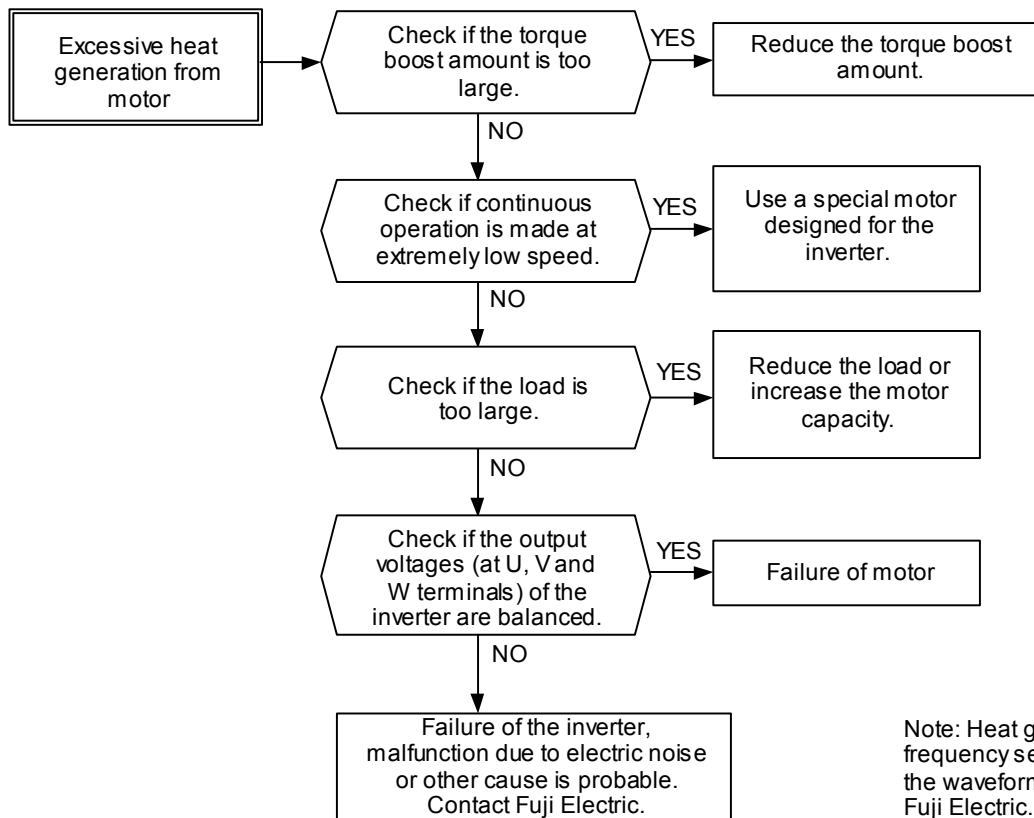

Note: Heat generation with a large frequency setting may be caused by the waveform of the current. Contact Fuji Electric.

8. Maintenance and Inspection

Perform daily and periodic inspection to avoid trouble and keep reliable operation for a long time. Take care of the following items during work.

8-1 Daily Inspection

Visually inspect errors in the state of operation from the outside without removing covers while the inverter operates or while it is turned on.

- 1) Check if the expected performance (satisfying the standard specification) is obtained.
- 2) Check if the surrounding environment satisfies the standard specification.
- 3) Check that the display of the keypad panel is free from errors.
- 4) Check for abnormal noise, excessive vibration and bad smell.
- 5) Check for traces of overheat, discoloration and other defects.

8-2 Periodic Inspection

After stopping the operation, turn the power off and remove the front cover to perform periodic inspection. The smoothing capacitor at the DC section of the main circuit takes time to be discharged after the power is turned off. After checking that the charge lamp (CRG) is unlit, check that the DC voltage is lower than the safety level (25 VDC) using a multimeter or the like before starting work.

 WARNING	<ul style="list-style-type: none"> • Turn the power off and wait for at least five minutes before starting inspection. (Further, check that the charge lamp is unlit and measure the DC voltage across the P (+) and N (-) terminals to check that it is lower than 25V.) Otherwise electric shock could occur. • Maintenance and inspection and parts replacement should be made only by appointed persons. (Take off the watch, rings and other metallic matter before starting work.) (Use insulated tools.) • Never remodel. Otherwise electric shock or injuries could occur.
--	---

Table 8-2-1 List of periodic inspection

Check part	Check item	How to inspect	Evaluation criteria
Environment	<ol style="list-style-type: none"> 1) Check the ambient temperature, humidity, vibration and atmosphere (dust, gas, oil mist, water drops). 2) Check if tools or other foreign matter or dangerous objects are left around the equipment. 	<ol style="list-style-type: none"> 1) Check visually or measure using apparatus. 2) Visual inspection 	<ol style="list-style-type: none"> 1) The standard specification must be satisfied. 2) No foreign or dangerous objects are left.
Voltage	Check if the voltages of the main circuit and control circuit are correct.	Measure using a multimeter or the like.	The standard specification must be satisfied.
Keypad panel	<ol style="list-style-type: none"> 1) Check if the display is clear. 2) Check if there is missing parts in the characters. 	1), 2) Visual inspection	1, 2) The display can be read and there is no fault.
Structure such as frame and cover	<ol style="list-style-type: none"> 1) Abnormal noise and excessive vibration 2) Loose bolts (tightened parts) 3) Deformation and breakage 4) Discoloration and deformation caused by overheat 5) Stains and dust 	<ol style="list-style-type: none"> 1) Visual or hearing inspection 2) Retighten. 3), 4), 5) Visual inspection 	1),2),3),4),5) No abnormalities

Main circuit	Common	1) Check if bolts and screws are tight and not missing. 2) Check the devices and insulators for deformation, cracks, breakage and discoloration caused by overheat and deterioration. 3) Check for foulness and dust.	1) Retighten. 2), 3) Visual inspection	1), 2), 3) No abnormalities
	Conductor and wire	1) Check the conductor for discoloration and distortion caused by overheat. 2) Check the sheath of the cable for cracks and discoloration.	1), 2) Visual inspection	1), 2) No abnormalities
	Terminal block	Damage	Visual inspection	No abnormalities
	Smoothing capacitor	1) Check for electrolyte leakage, discoloration, cracks and swelling of the case. 2) Check for safety valve protrusion and remarkably protruding valve 3) Measure the capacitance.	1), 2) Visual inspection 3) Monitor H42 Life judgment and measure with capacitance probe.	1), 2) No abnormalities 3) Capacitance \geq (Initial value) x 0.85
Main circuit	Resistor	1) Check for odor caused by overheat and cracked insulator. 2) Check for broken wire.	1) Smelling and visual inspection 2) Visual inspection or measurement with multimeter under disconnection of one lead	1) No abnormalities 2) Within $\pm 10\%$ of displayed resistance
	Transformer	Check for abnormal roaring noise and odor.	Hearing, visual and smelling inspection	No abnormalities
	Relay	1) Check for chatters during operation. 2) Check for rough contacts.	1) Hearing inspection 2) Visual inspection	1),2) No abnormalities
Control circuit	Control printed circuit board, connector	1) Check for loose screws and connectors. 2) Check for odor and discoloration. 3) Check for cracks, breakage, deformation and remarkable rust. 4) Check the capacitors for electrolyte leaks and deformation.	1) Retighten. 2) Smelling and visual inspection 3), 4) Visual inspection	1),2),3),4) No abnormalities
Cooling system	Cooling fan	1) Check for abnormal noise and excessive vibration. 2) Check for loose bolts. 3) Check for discoloration caused by overheat.	1) Hearing and visual inspection, or turn manually (be sure to turn the power off). 2) Retighten. 3) Visual inspection 4) Life judgment based on maintenance data*	1) Smooth rotation 2),3) No abnormalities
	Ventilation path	Check the heat sink, intake and exhaust ports for clogging and foreign matter.	Visual inspection	No abnormalities

Remarks: Remove foulness using cleaning cloth which is chemically neutral. Use a vacuum cleaner to remove dust.

* Judgment of life using maintenance data

The maintenance data of function codes H42 and H43 can be used to display data for the judgment of the capacitance of the capacitor in the main circuit and the life of the cooling fan to obtain a measure for the judgment of parts replacement. The capacitor life forecast signal is issued at the Y1 and Y2 terminals according to the measured capacitance after the capacitance of the capacity reaches 85%.

(1) Measurement of capacitance of capacitor in main circuit

This inverter is provided with a function where the capacitance of the main circuit capacitor is automatically measured upon shutoff of the inverter under certain conditions and it is displayed on the keypad panel upon power-up.

The capacitance of the capacitor is displayed in the reduction ratio (% display) of the initial value stored inside the inverter before shipment.

Procedure of measurement of capacitor capacitance

1. Remove the optional card from the inverter if it is mounted. Disconnect the braking unit or direct current bus to another inverter from the P (+) and N (-) terminals of the main circuit if there is any. The power factor improving reactor (DC reactor) may not be disconnected.
2. Turn the digital inputs (FWD, REV, X1-X5) at the control terminals off. Disconnect the RS 485 communication terminal if it is connected.
3. Turn the main power supply on. Check that the cooling fan rotates. Check that the inverter is stopped. (The "OH2 external alarm" caused by deactivated digital input terminals does not cause a problem.)
4. Turn the main power supply off.
5. After the charge lamp is unlit completely, turn the main power supply on again.
6. Monitor function code H42 to check the capacitor capacitance (%).

(2) Life of cooling fan

Function code H43 indicates the total operation time of the cooling fan. The time is integrated in units of an hour and fractions shorter than an hour are ignored.

The actual life of the fan is largely effected by the temperature. Take the time as a measure.

Table 8-2-2 Measure for judgment of life based on maintenance data

Part	Judgment level
Main circuit capacitor	85% or lower of the initial value
Cooling fan	30,000 hours (4.0 kW or less), 25,000 hours (5.5 kW or more) *1

*1: Assumed life of cooling fan at ambient inverter temperature of 40 degree C.

8-3 Measurement of Electrical Amounts in Main Circuit

Because the voltage and current of the power supply (input) of the main circuit of the inverter and the output (motor) include harmonic components, the indicated value varies according to the type of the meter. Use meters indicated in Table 8-3-1 when measuring with meters for commercial frequencies. Marketed power factor meters measuring phase difference between the voltage and current cannot measure the power factor. To obtain the power factor, measure the power, voltage and current on each of the input and output sides and calculate in the following formula.







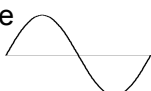
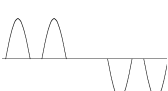

In case of Three-phase

$$\text{Power factor} = \frac{\text{Electric power[W]}}{\sqrt{3} \times \text{Voltage[V]} \times \text{Current[A]}} \times 100[\%]$$

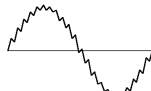
In case of Single-phase

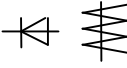
$$\text{Power factor} = \frac{\text{Electric power[W]}}{\text{Voltage[V]} \times \text{Current[A]}} \times 100[\%]$$

Table 8-3-1 Meters for measurement of main circuit

Item	Input (power supply) side			Output (motor) side			Link voltage (P(+)-N(-))
	Voltage 	Current 		Voltage 	Current 		
Name of meter	Ammeter $A_{R,S,T}$	Voltmeter $V_{R,S,T}$	Wattmeter $W_{R,S,T}$	Ammeter $A_{U,V,W}$	Voltmeter $V_{U,V,W}$	Wattmeter $W_{U,V,W}$	DC voltmeter V
Type of meter	Moving iron type	Rectifier or moving iron type	Digital power meter	Moving iron type	Rectifier type	Digital power meter	Moving coil type
Symbol of meter							

Note) When the output voltage is measured by a rectifier type, an error may be included. To increase the accuracy, use a digital AC power meter.

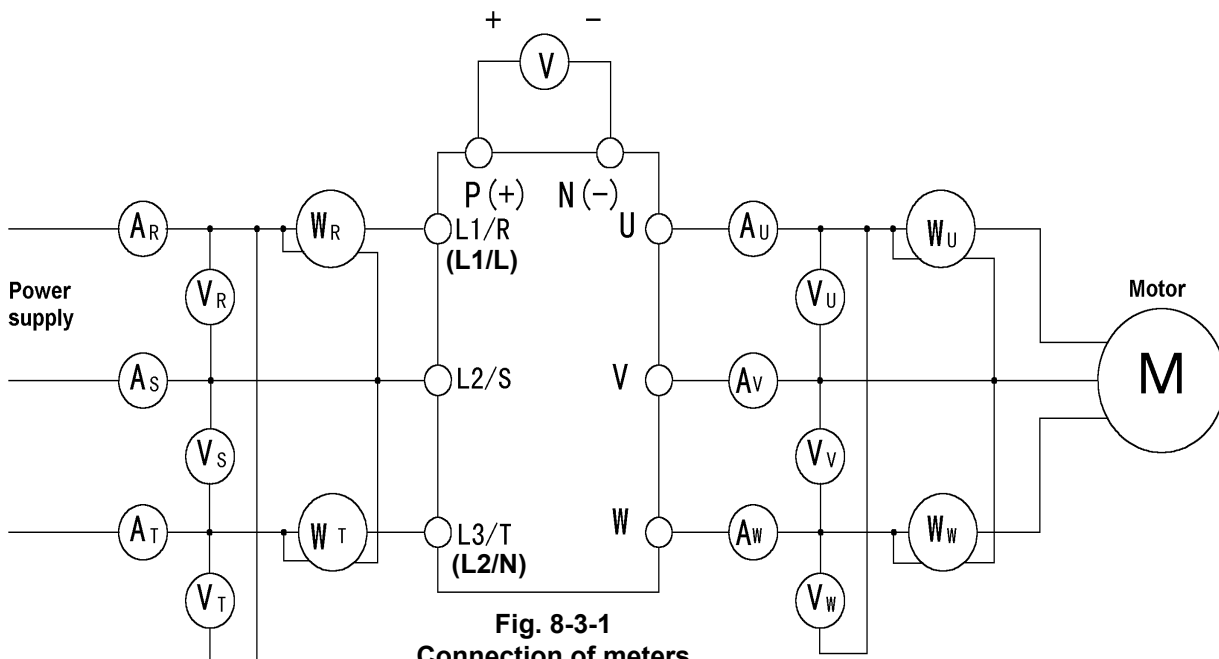

Fig. 8-3-1
Connection of meters

8-4 Insulation Test

Because an insulation test is made in the factory before shipment, avoid a Megger test. If a Megger test is unavoidable, follow the procedure below. Because a wrong test procedure will cause breakage of the inverter, take sufficient care.

A withstand voltage test will cause breakage of the inverter similarly to the Megger test if the test procedure is wrong. When the withstand voltage test is necessary, contact your dealer or nearest Fuji Electric's branch.

(1) Megger test of main circuit

- 1) Use a 500 VDC Megger and shut off the main power supply without fail during measurement.
- 2) If the test voltage leaks to the control circuit due to the wiring, disconnect all the control wiring.
- 3) Connect the main circuit terminals with a common cable as shown in Fig. 8-4-1.
- 4) The Megger test must be limited to across the common line of the main circuit and the ground terminal (⊕G).
- 5) MΩ or a larger value displayed at the Megger indicates a correct state. (The value is for a discrete inverter.)

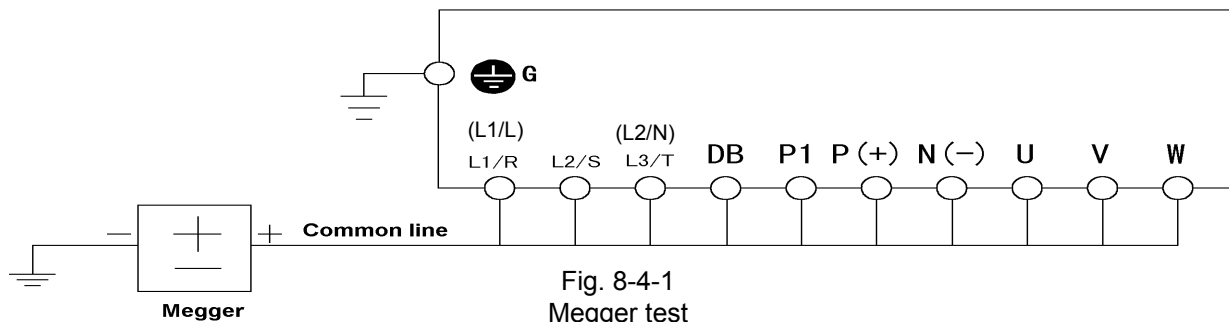

Fig. 8-4-1
Megger test

(2) Do not perform a Megger test or withstand voltage test to the insulation test control circuit of the control circuit. Prepare a high resistance range tester for the control circuit.

- 1) Disconnect all the external wiring from the control circuit terminals.
- 2) Perform a continuity test to the ground. 1 MΩ or a larger measurement indicates a correct state.

(3) External main circuit and sequence control circuit

Disconnect all the inverter terminals so that the test voltage is not applied.

8-5 Replacement Parts

The life of the part is determined by the type of the part. The life of the part varies according to the environment and operating conditions, and replacement according to Table 8-5-1 is recommended.

8-6 Inquiries about Product and Guarantee

Table 8-5-1 Replacement parts

(1) When making an inquiry

Upon breakage of the product, uncertainties, failure or inquiries, report the following information to your dealer or nearest Fuji Electric's branch.

- a) Inverter type
- b) SER NO. (serial number of equipment)
- c) Date of purchase
- d) Inquiries (for example, point and extent of breakage, uncertainties, failure phenomena, and other circumstances)

Name of part	Standard replacement years	Replacement method and others
Cooling fan	3 years	Replace with a new part.
Smoothing capacitor	5 years	Replace with a new part. (Replace after inspection.)
Electrolytic capacitors on printed circuit board	7 years	Replace with new circuit board. (Replace after inspection.)
Other parts	—	Determine after inspection.

(2) Guarantee of the product

The product guarantee term is one year after the purchase or 24 months from the month and year of production specified on the nameplate, whichever comes first. However, the product will not be repaired free of charge in the following cases, even if the guarantee term has not expired.

- a) The cause includes incorrect usage or inappropriate repairs or remodeling.
- b) The product is used outside the standard specified range.
- c) The failure is caused by dropping, damage or breakage during transportation after the purchase.
- d) The cause is earthquake, fire, storm or flood, lightning, excessive voltage, or other types of act of God or secondary disasters.

9. Specifications

9-1 Standard Specifications

(1) Single-phase 200V input

Item		Detail specifications					
Inverter type FVR__E11S-7EN		0.1	0.2	0.4	0.75	1.5	2.2
Nominal applied motor ^{*1} [kW]		0.1	0.2	0.4	0.75	1.5	2.2
Output ratings	Rated capacity ^{*2} [kVA]	0.31	0.59	1.1	1.9	3.1	4.3
	Rated voltage ^{*3} [V]	Three-phase 200V / 50 Hz, 200V, 220V, 230V / 60 Hz (with AVR function)					
	Rated current ^{*4} [A]	0.8 (0.7)	1.5 (1.4)	3.0 (2.5)	5.0 (4.0)	8.0 (7.0)	11 (10)
	Overload capability	150% of rated output current for 1 min. 200% of rated output current for 0.5 s					
	Rated frequency [Hz]	50, 60Hz					
Input ratings	Phases, Voltage , Frequency	Single-phase 200 to 240 V / 50 to 60 Hz ^{*10}					
	Voltage/frequency fluctuation	Voltage : +10 to -10% Frequency : +5 to -5%					
	Momentary voltage dip capability ^{*5}	Operation continues at 165V or higher voltage. When the input voltage drops below 165V from the rated voltage, operation continues for 15 ms.					
	Rated current [A] (With DCR) ----- (Without DCR) ^{*9}	1.2	2.0	3.5	6.5	11.8	17.7
	Required power supply capacity ^{*6} [kVA]	0.3	0.4	0.7	1.3	2.4	3.6
Braking	Braking torque ^{*7} [%]	100		70		40	
	Braking torque ^{*8} [%]	150					
	DC braking	Starting frequency: 0.0 to 60 Hz, braking current (0 to 100% in 1% increment), braking time (0.0 to 30.0 s)					
Enclosure(IEC60529)	IP20						
Cooling method	Natural cooling				Fan cooling		
Mass [kg]	0.6	0.7	1.2	1.8	1.9		

*1 The applicable standard motor indicates the case for a 4P standard motor made by Fuji Electric.

*2 The rated capacity indicates the case for 230V output voltage.

*3 Voltages larger than the source voltage cannot be output.

*4 Amperage values in parentheses () are applicable to operation with 4 kHz or higher carrier frequencies (F26 = 4 or more) or ambient temperatures exceeding 40 degree C.

*5 Tests at standard load condition (85% load)

*6 Indicates the value when using a DC reactor (DCR).

*7 Indicates the average braking torque for decelerating and stopping a discrete motor from 60 Hz. (Varies according to the efficiency of the motor.)

*8 Indicates the value with an external braking resistor (option).

*9 Calculated on assumption that the inverter is connected to 500kVA power supply.

*10 Safe separation for control interface of this inverter is provided when this inverter is installed in overvoltage category II. Basic insulation for control interface of this inverter is provided when this inverter is installed in overvoltage category III.

(2) Three-phase 400V input

Item		Detail specifications							
Inverter type FVR__E11S-4EN		0.4	0.75	1.5	2.2	4.0	5.5	7.5	
Nominal applied motor ^{*1} [kW]		0.4	0.75	1.5	2.2	4.0	5.5	7.5	
Output ratings	Rated capacity ^{*2} [kVA]	1.0	1.7	2.6	3.9	6.4	9.3	12	
	Rated Voltage ^{*3} [V]	Three-phase 380,400,415V/50Hz, 380,400,440,460V/60Hz (with AVR function)							
	Rated current ^{*4} [A]	1.5 (1.4)	2.5 (2.1)	3.7 (3.7)	5.5 (5.3)	9.0 (8.7)	13 (12)	18 (16)	
	Overload capability	150% of rated output current for 1 min. 200% of rated output current for 0.5s							
	Rated frequency [Hz]	50, 60Hz							
Input ratings	Phases, Voltage, Frequency	Three-phase 380 to 480 V / 50 to 60Hz ^{*11}							
	Voltage/frequency fluctuation	Voltage : +10 to -15% Voltage unbalance 2% or less ^{*10} Frequency : +5 to -5%							
	Momentary voltage dip capability ^{*5}	Operation continues at 300V or higher voltage. When the input voltage drops below 300V from the rated voltage, operation continues for 15 ms.							
	Rated current [A] (With DCR)	0.82	1.5	2.9	4.2	7.1	10.0	13.5	
	(Without DCR) ^{*9}	1.8	3.5	6.2	9.2	14.9	21.5	27.9	
Required power supply capacity ^{*6} [kVA]	0.6	1.1	2.1	3.0	5.0	7.0	9.4		
Braking	Braking torque ^{*7} [%]	70		40		20			
	Braking torque ^{*8} [%]	150							
	DC braking	Starting frequency: 0.0 to 60.0 Hz, braking current (0 to 100% in 1% increment), braking time (0.0 to 30.0 s)							
Enclosure(IEC60529)		IP20							
Cooling method		Natural cooling			Fan cooling				
Mass [kg]		1.1	1.2	1.3	1.4	1.9	4.5		

*1 The applicable standard motor indicates the case for a 4P standard motor made by Fuji Electric.

*2 The rated capacity indicates the case for 415V output voltage.

*3 Voltages larger than the source voltage cannot be output.

*4 Amperage values in parentheses () are applicable to operation with 4 kHz or higher carrier frequencies (F26 = 4 or more) or ambient temperatures exceeding 40 degree C.

*5 Tests at standard load condition (85% load)

*6 Indicates the value when using a DC reactor (DCR).

*7 Indicates the average braking torque for decelerating and stopping a discrete motor from 60 Hz. (Varies according to the efficiency of the motor.)

*8 Indicates the value with an external braking resistor (option).



*9 Calculated on assumption that the inverter is connected to 500kVA power supply.

*10 Refer to IEC61800-3 5.2.3.

*11 Safe separation for control interface of this inverter is provided when this inverter is installed in overvoltage category II. Basic insulation for control interface of this inverter is provided when this inverter is installed in overvoltage category III.

9-2 Common Specifications

Item		Detail specifications	
Output frequency	Adjustment	Maximum frequency	50 to 400 Hz variable
		Base frequency	25 to 400 Hz variable
		Starting frequency	0.1 to 60.0 Hz variable, Holding time : 0.0 to 10.0s.
		Carrier frequency	0.75 to 15 kHz (The carrier frequency may automatically drop to 0.75 kHz to protect the inverter.)
	Accuracy	Analog setting: Within $\pm 0.2\%$ ($25 \pm 10\text{ }^\circ\text{C}$) Digital setting: Within 0.01% (-10 to +50 $^\circ\text{C}$)	
Setting resolution	Analog setting: 1/3000 of maximum output frequency Keypad panel setting: 0.01 Hz (99.99 Hz or lower), 0.1 Hz (100.0 to 400.0 Hz) Link setting : 1/20000 of Maximum frequency (0.003Hz at 60Hz,0.006Hz at 120Hz,0.02Hz at 400Hz) or 0.01Hz (Fixed)		
Control	Voltage/freq. Characteristics	Adjustable at base and maximum frequency, with AVR control : 80 to 240 V(200V class),160 to 480V(400V class)	
	Torque boost	Automatic : Automatic torque boost can be selected with code setting. Manual : Setting by codes 1 to 31 (Boost for Variable torque available)	
	Starting torque	Starting torque 200% or above (with dynamic torque vector turned on, during 0.5 Hz operation)	
	DC braking	Braking time (0.0 to 30.0 s), braking current (0 to 100%), braking starting frequency (0.0 to 60.0 Hz) variable	
	Control method	Sinusoidal PWM (Dynamic torque vector control) with "current vibration suppression function" and "dead time compensation function"	
	Operation method	Keypad operation: starting and stopping with (RUN) and (STOP) keys. (Keypad panel) Digital input signal: forward (reverse) operation, stop command (3-wire operation possible), coast-to-stop command, external alarm, error reset, etc. Link operation : RS485 (Standard) Profibus-DP,Interbus-S,DeviceNet,Modbus Plus, CAN open (Option)	

Item	Detail specifications
Frequency setting (UP/DOWN control) (Multistep frequency) (Link operation)	Keypad operation:  key and  key. Setting with potentiometer (external potentiometer: 1 to 5 kΩ 1/2 W) Setting with 0 to ± 5 Vdc. Setting with 0 to ± 10 Vdc. Setting with 4 to 20 mAdc. 0 to +10 Vdc / 0 to 100% can be switched to +10 to 0 Vdc / 0 to 100% externally. 4 to 20 mAdc / 0 to 100% can be switched to 20 to 4 mAdc / 0 to 100% externally. An external signal can be used to control the UP or DOWN command. Up to 16 different frequencies can be selected by digital input signals. Link operation : RS485 (Standard) Profibus-DP, Interbus-S, DeviceNet, Modbus Plus, CAN open (Option)
Acceleration / deceleration time (Mode select)	Variable setting in 0.01 to 3600s range. (2 sets of time can be set internally for each of acceleration and deceleration.) Linear, S-curve (weak, strong), Non-linear available.
Frequency limiter	The high and low frequency limits can be set variably in a 0 to 100% range in Hz.
Bias frequency	Can be set variably in -400 to 400 Hz range.
Gain (frequency setting)	Can be set variably in a 0 to 200% range.
Jump frequency control	Three jump frequencies and jump width (0 to 30 Hz) can be set.
Rotating motor pickup (Flying start)	Operation without shock is possible.
Auto-restart after momentary power failure	The motor speed can be detected after power recovery so that the motor is started at the speed.
Slip compensation control	The load during regular operation can be detected for the control of the frequency. The compensation value can be set variably in a 0.00 to +15.00 Hz range to the rated frequency.
Droop operation	The load during regular operation can be detected for the control of the frequency. The compensation value can be set in a -9.9 to 0.0 Hz range to the rated frequency. (Speed droop characteristics)
Torque limiter	When the load torque in the driving or braking mode exceeds the setting, the frequency is controlled to control the load torque to an almost constant level. The limiting torque can be set 20 to 200% and the driving and braking torque values can be independently set. The second torque limits can be set.

Item		Detail specifications
Control	PID control	<p>This function can control flowrate, pressure, etc. with analog feedback signal. The reference and feedback values are displayed in %.</p> <p>Reference signal Keypad operation (▲) key and (▼) key. : 0.0 to 100%</p> <p>Voltage input (Terminal 12) : 0 to 10Vdc Current input (Terminal C1) : 4 to 20mAdc Multistep frequency setting : Setting freq./Max. freq.x100% RS485 : Setting freq./Max. freq.x100%</p> <p>Feedback signal Terminal 12 (0 to +10Vdc or +10 to 0Vdc) Terminal C1(4 to 20mAdc or 20 to 4mAdc)</p>
	Second motor's setting	<p>The V/f pattern of the second motor can be internally set for selection by means of an external signal.</p> <p>The constant of the second motor can be internally set for selection by means of an external signal.</p> <p>The electronic thermal overload relay of the second motor can be internally set for selection by means of an external signal.</p>
	Energy saving operation	Weak magnetic flux can be set for small loads for operation with an increased motor efficiency.
Display	During operation/stop	<p>The keypad panel can be extended. (Optional 5m extension cable is available.)</p> <p>7-segment LED display items</p> <ul style="list-style-type: none"> • Set frequency • Output frequency • PID setting/feedback value • Output current • Motor r/min • Output voltage • Line speed <p>(A soft filter is provided to attenuate the fluctuation in the displayed value.) A charge lamp indicates power supply.</p>
	When setting	The function code and data code are displayed.
	When tripping	<p>[The cause of tripping is displayed.]</p> <ul style="list-style-type: none"> • OC1 (overcurrent: during acceleration) • OC2 (overcurrent: during deceleration) • OC3 (overcurrent: during constant speed operation) • OU1 (overvoltage: during acceleration) • OU2 (overvoltage: during deceleration) • OU3 (overvoltage: during constant speed operation) • LU (undervoltage) • Lin (input phase loss) (for 3-phase inverter) • dbH (external damping resistor overheat (thermal overload relay)) • OH1 (overheat: heat sink) • OH2 (overheat: external thermal overload relay) • OL1 (overload: motor 1) • OL2 (overload: motor 2) • OLU (overload: inverter) • Er1 (memory error) • Er2 (keypad panel communication error) • Er3 (CPU error) • Er4 (option error) • Er5 (option error) • Er7 (output wiring error) (impedance imbalance) • Er8 (RS485 communication error)
	During operation, when tripping	The latest four records of trip history are stored and displayed.

Item		Detail specifications								
Protection	Overload protection	Inverter protection electronic thermal overload relay								
	Overvoltage protection	An excess in the DC link circuit voltage (approx. 400 Vdc for 200V class, approx. 800Vdc for 400V class) is detected for inverter protection.								
	Overcurrent protection	The inverter is protected against an overcurrent caused by an overload on the output side.								
	Surge protection	The inverter is protected against a surge voltage penetrating between the power supply cable of the main circuit and the ground.								
	Undervoltage protection	Voltage drop (approx. 200 Vdc for 200V class, approx. 400Vdc for 400V class) in the DC link circuit voltage is detected to stop the inverter.								
	Overheat protection	The inverter is protected against failure and overload of the cooling fan.								
	Short-circuit protection	The inverter is protected against an overcurrent caused by a short-circuit on the output side.								
	Ground fault protection	The inverter is protected against an overcurrent caused by ground fault in the output wiring. * Detection when starting								
	Motor protection	Electronic thermal overload relays protect general purpose motors and Fuji's inverter motor. The thermal time constant can be adjusted to 0.5 to 10.0 min. Second electronic thermal overload relay can be provided. (Switching with external signal)								
	Braking resistor protection	Upon an overheat of the damping resistor (external unit), discharging operation and inverter operation stop								
	Stall prevention (simple torque limit)	<ul style="list-style-type: none"> When the output current exceeds the limit during acceleration, the frequency change is stopped to avoid overcurrent stop. When the output current exceeds the setting during constant speed operation, the frequency is decreased to maintain an almost constant torque. When the DC voltage exceeds the limit during deceleration, the frequency change is stopped to avoid overvoltage stop. 								
	Input phase loss protection	The inverter is protected against phase loss in the input voltage.								
	Output phase loss protection	An unbalance in the impedance of the output circuit is detected to output an alarm. (Error during tuning only)								
Auto reset	The number of retries and wait time can be set for the alarm stop.									
Environment	Installation location	<ul style="list-style-type: none"> Indoors Places without corrosive gases, flammable gases or dust (degree of pollution: 2) Places without direct sunlight 								
	Ambient temperature	-10 to +50 °C								
	Relative humidity	5 to 95% RH (without condensation)								
	Altitude	1000 m Max. (Atmospheric pressure 86 to 106 kPa)								
	Vibration	<table border="0"> <tr> <td>3mm</td> <td>2 to 9 Hz</td> </tr> <tr> <td>9.8m/s²</td> <td>9 to 20 Hz</td> </tr> <tr> <td>2m/s²</td> <td>20 to 55 Hz</td> </tr> <tr> <td>1m/s²</td> <td>55 to 200 Hz</td> </tr> </table>	3mm	2 to 9 Hz	9.8m/s ²	9 to 20 Hz	2m/s ²	20 to 55 Hz	1m/s ²	55 to 200 Hz
	3mm	2 to 9 Hz								
	9.8m/s ²	9 to 20 Hz								
2m/s ²	20 to 55 Hz									
1m/s ²	55 to 200 Hz									
Storage temperature	-25 to +65 °C									
Storage humidity	5 to 95% RH (without condensation)									

9-3 External Dimensions

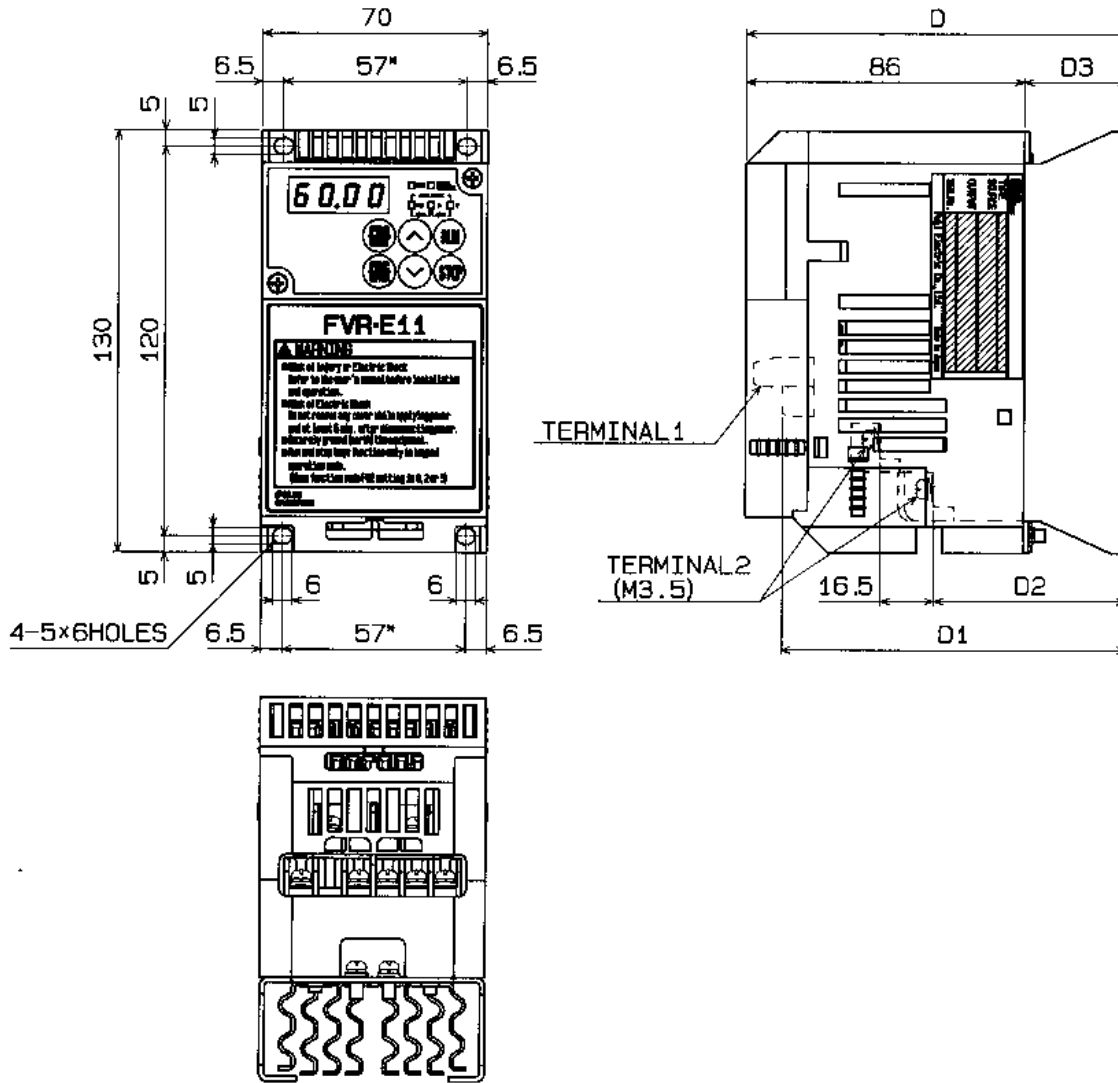

Type	Standard applicable motor [kW]	External dimensions (mm)			
		D	D1	D2	D3
FVR0.1E11S-7EN	0.1	96	85	38	10
FVR0.2E11S-7EN	0.2	101	90	43	15
FVR0.4E11S-7EN	0.4	118	107	60	32

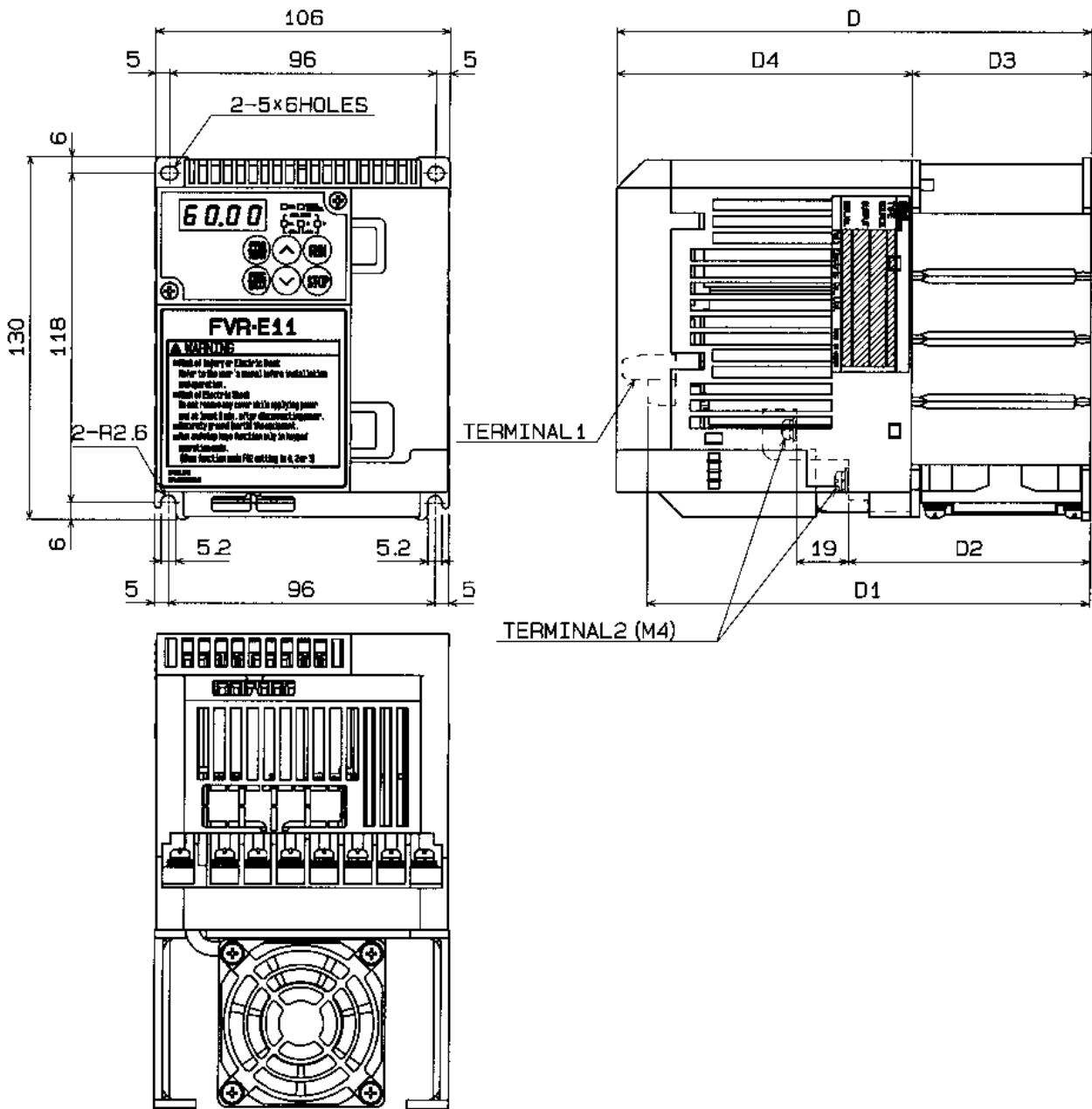

Installation screw size : M4 (4 pcs)

Type	Standard applicable motor [kW]	External dimensions (mm)				
		D	D1	D2	D3	D4
FVR0.75E11S-7EN	0.75	126	115	63	40	86
FVR0.4E11S-4EN	0.4	126	115	63	40	86
FVR0.75E11S-4EN	0.75	150	139	87	64	86
FVR1.5E11S-4EN	1.5	170	159	87	64	106
FVR2.2E11S-4EN	2.2	170	159	87	64	106

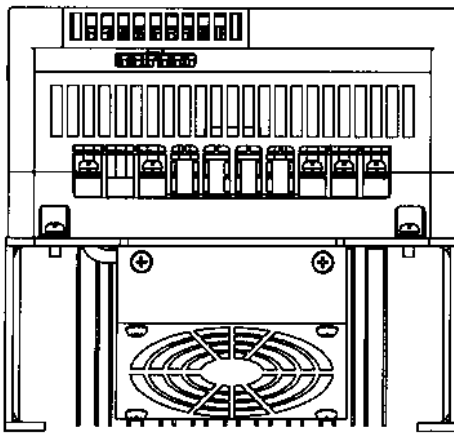
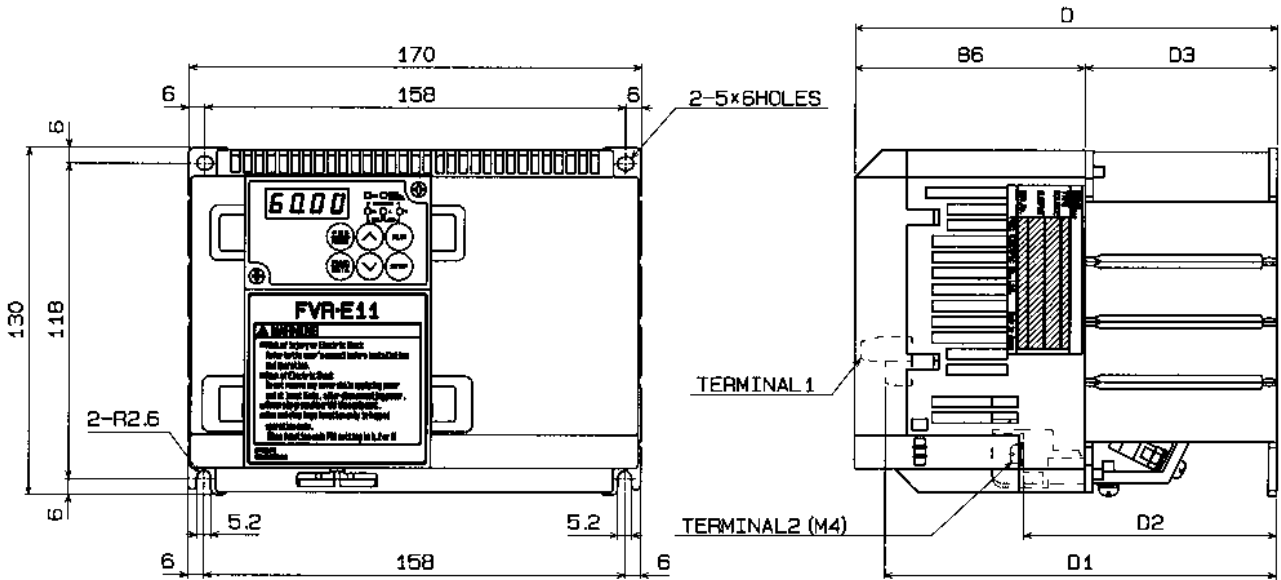

Installation screw size : M4 (4 pcs)

Type	Standard applicable motor [kW]	External dimensions (mm)			
		D	D1	D2	D3
FVR1.5E11S-7EN	1.5	158	147	95	72
FVR2.2E11S-7EN	2.2				
FVR4.0E11S-4EN	4.0				

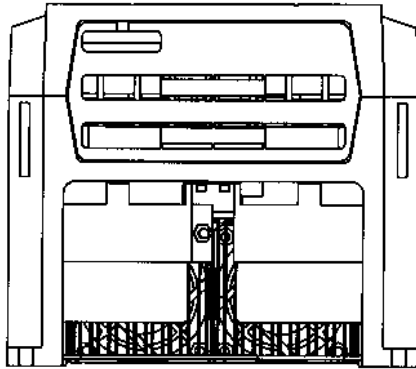
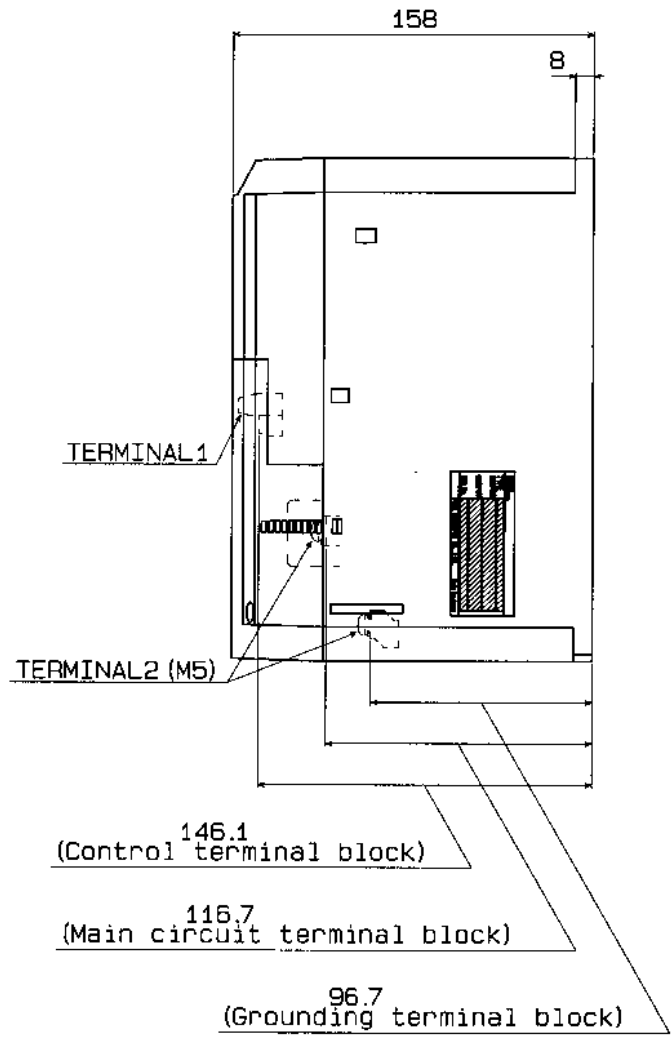
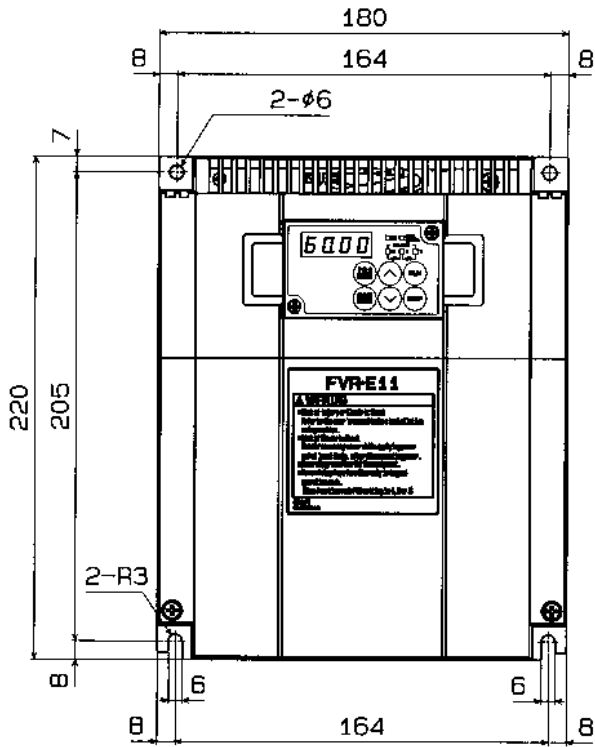

Installation screw :size : M5 (4pcs)

FVR5.5E11S-4EN
FVR7.5E11S-4EN

9-4 RS485 Communication

Remove the keypad panel of the inverter referring to section 1-3 (3) and use the connector having been connected with the keypad panel to connect up to 31 inverters in a line to perform the following operations.

- Frequency setting, forward/reverse rotation, stop, coast to stop, alarm reset and other operations
- Monitoring of output frequency, output current, operation state, alarm description, and so on
- Setting of function code data (function code data, command data and monitor data)

The transmission frame is character data having a fixed length of 16 bytes, so that development of programs for the host controller is easy. The operation and frequency setting command requiring fast speeds can be in a short frame for shorter communication time. The functions of the serial communication connector are shown in Table 9-4-1.

Table 9-4-1 Functions of serial communication connector

Terminal No.	Terminal symbol	Name of terminal	Specification
4	DX+	RS 485 communication signal (not inverse)	Connection of serial communication signal; compliance with RS485
3	DX-	RS485 communication signal (inverse)	

The leftmost terminal of the connector when viewed from the front of the inverter is terminal 1. Never connect the terminals other than the above because signal cables used for the keypad panel are connected. A terminator is built in the inverter.

Turn SW2 on (left side) below the serial communication connector for the inverter connected at the end of the cable to connect the terminator.

When you communicate more than one inverter, use a branch adapter in the table 9-4-2 and connect like Fig9-4-2.

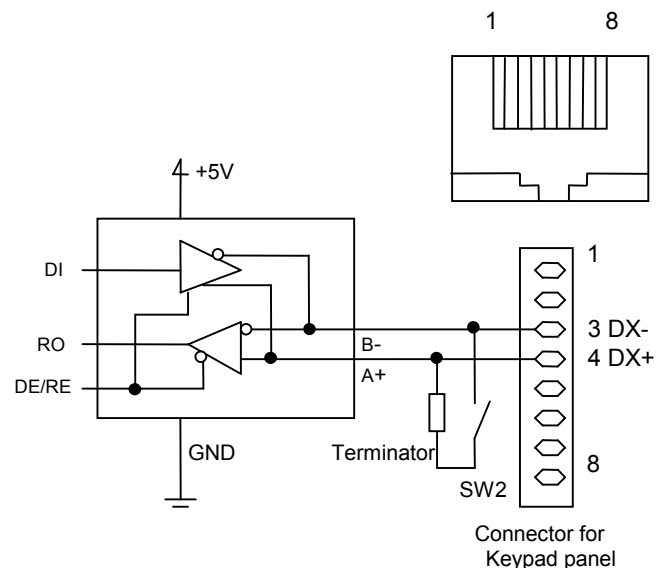
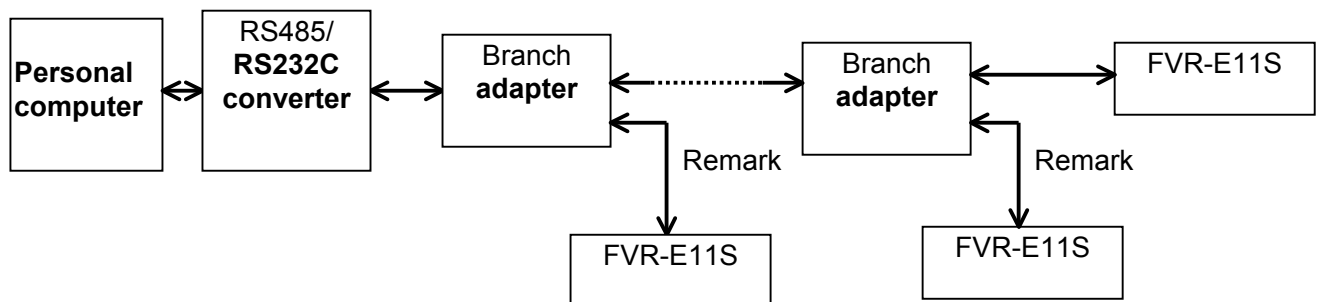

Fig. 9-4-1 Equivalent circuit of RS485 interface



Remark)The branched cable length has to be 1m or less.
Terminattor in the branched inverter has to be OFF.(SW2 OFF)

Fig. 9-4-2 Communication method with more than one inverter

9-4-1 Connector and Communication Cable

Use marketed products for the connector, the communication cable and branch adapter. Table 9-4-2 shows the specification of each of them.

Table 9-4-2 Connector and cable specification

Item	Specification
Connector	RJ45 connector
Cable	Cable complying with EIA568 (for 10BASE-T Straight connection) (Max. wiring length: 500m)
Branch adapter	MS8-BA-JJJ (SK KOHKI CO., LTD or equivalent.)

9-4-2 Recommended RS-232C/RS485 Converter

For communications with PCs having an RS232C terminal, the following insulation type converter is recommended.

- Model : KS485PT1
- Manufacture : System Sakom

9-4-3 Remote/local changeover

Operation between according to the frequency setting and operation commands sent via serial communication, and according to the frequency setting and operation commands set in the inverter main body, can be switched over.

The frequency setting and operation command selection is made as follows, using function H30 and remote/local switching.

The function of any of the X1 through X5 terminals of the inverter main body is changed to be the LE terminal which is used for remote/local switching. Any of the functions E01 through E05 is used to change the function of X1 to X5 terminal. If X1 through X5 terminals are not assigned to the LE terminal, it is always in the remote mode.

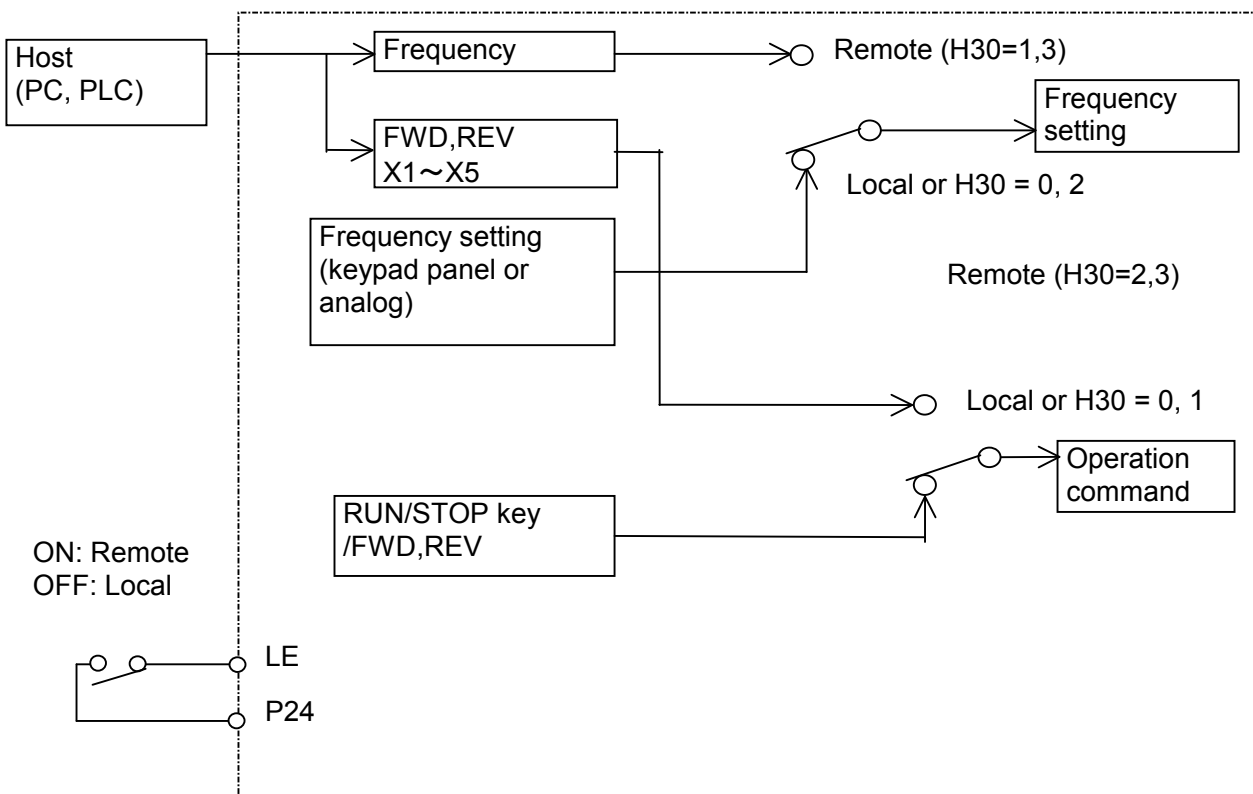

Fig. 9-4-3 Command switching block diagram

When X1 through X5 terminals are assigned with BX, THR and RST functions, the BX, THR and RST functions are activated even in the remote mode according to the inputs to the terminals. RS485 can not make THR ON/OFF.

9-4-4 Communication Protocol

(1) Serial communication specification

Table 9-4-3 Serial communication specification

Physical level	Compliance with EIA RS-485 (2-wire type)
Number of connected stations	Host x 1 unit, inverter x 31 units (Station address 1 to 31)
Transmission speed	19200, 9600, 4800, 2400, 1200[bit/s]
Synchronization method	Start-stop
Transmission method	Half duplex
Transmission protocol	Polling/selecting, broadcast
Character type	ASCII 7 bits
Character length	Selection between 7 and 8 bits
Transmission distance	Max. 500 m
Stop bit	Selection between 1 and 2 bits
Frame length	Standard frame: fixed to 16 bytes, short frame: 8 or 12 bytes
Parity	Selection from none, even and odd
Error check method	Checksum, parity, framing error

(2) Transmission protocol

It is the half duplex communication in the polling/selecting method. The inverter always waits for a write request (selecting) or a read request (polling) from the host. The inverter, when receiving in the wait state a request frame to the own station from the host, returns a response frame. Upon polling, it returns data together. In the case of broadcasting (selection of all stations in a batch), no response is returned.

• Polling/selecting

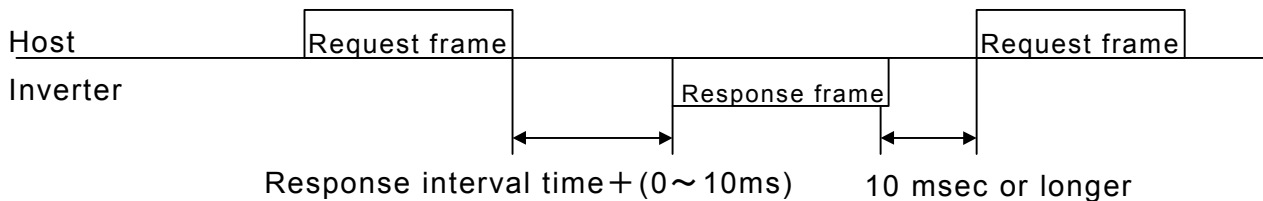

• Broadcast

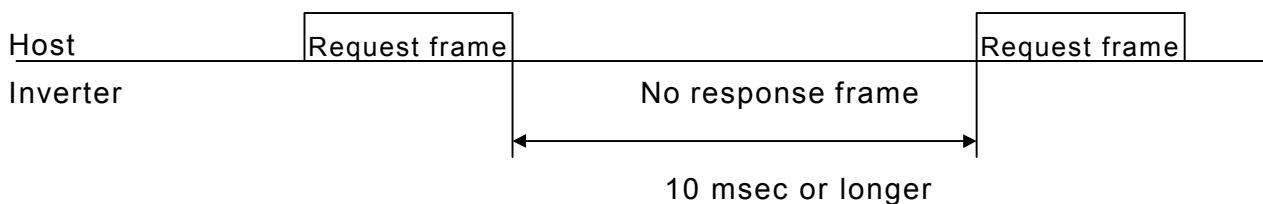

(3) Transmission procedure

- 1) Set communication functions H30 through H39.
- 2) Make communication according to transmission frames.
- 3) If no response returns for one second from the inverter upon a frame from the host, retry communication. Several retries indicate certain errors. Make investigation.
- 4) If no communication is received from the host for 30 seconds after the first operation command is received, the inverter judges a transmission breakdown error and shuts down the inverter output, leaving the motor to coast to stop.
- 5) After consecutive eight communication errors, the inverter output is shut down and the motor coasts to stop.

(4) Host controller transmission procedure

Do not send the next frame unless the response is returned.

If the inverter does not respond for longer than the standard time, timeout should be judged and retry should be performed. If a retry is started before timeout, normal reception may become impossible, so that timeout should be judged correctly. The timeout time is one second in the selecting mode and 0.5 second in the polling mode. In the retry sequence, send the same frame again as that sent before no response, or send a polling (M26: communication error monitor) frame for reading an error, and check for a normal response. (Judge the timeout again during the check.)

If a normal response is returned, a transient transmission error due to noise or the like is indicated, and correct communication can be continued. If retries occur frequently, any abnormalities are probable. In-depth investigation is necessary. If no response is returned, continue retrying. If there are three retries, there is some trouble in the hardware or software of the host controller. Terminate the software of the host controller and investigate.

No error code is returned in the case of negative acknowledgment of a short frame. Judge the error code using the communication error monitor (M26) separately.

9-4-5 Standard Frame

The ASCII code character method is employed. A standard frame has a fixed length of 16 bytes. Using optional frames (12 bytes or 8 bytes), the transmission speed can be increased.

Host→Inverter frame

Note: Numbers with "H" at the end indicate hexadecimals.

	7(6)	0	
0	Start-of-heading character (SOH)		← Fixed to 01H.
1	Tens digit of station address (ASCII)		} Designate a station address of the destination inverter with 01 to 31 or 99. (ASCII designation of each digit)
2	Units digit of station address (ASCII)		
3	Enquiry character (ENQ)		← Fixed to 05H.
4	Command type character (ASCII)		← E: Reset command, R: Polling (reading), W: Selecting (writing)
5	Function type character (ASCII)		← "S", "M", "F", "E", "C", "P", "H" or "A" is designated.
6	Tens digit of function number (ASCII)		} Designate a function number using a two-digit number. (Designate each digit of 00 to 46 in ASCII.)
7	Units digit of function number (ASCII)		
8	Space (ASCII)		← Fixed to 20H
9	First character of data (ASCII)		} The data corresponding to the function is converted into a 4-digit hexadecimal, and each digit is designated in ASCII.
10	Second character of data (ASCII)		
11	Third character of data (ASCII)		
12	Fourth character of data (ASCII)		
13	End-of-text character (ETX)		← Fixed to 03H
14	Upper digit of checksum (ASCII)		} From tens digit of the station address to ETX are added in a binary and the lower two digits of it in hexadecimal notation are stored in ASCII as a checksum.
15	Lower digit of checksum (ASCII)		

Inverter→Host frame

	7(6)	0	
0	Start-of-heading character (SOH)		← Fixed to 01H
1	Tens digit of station address (ASCII)		} Station address of responding inverter (01 to 31) (ASCII designation of each digit)
2	Units digit of station address (ASCII)		
3	Response character (ACK/NAK)		← 06H: Normal response (ACK), 15H: Faulty response (NAK)
4	Command type character (ASCII)		← E: Reset command, R: Polling (reading), W: Selecting (writing)
5	Function type character (ASCII)		← "S", "M", "F", "E", "C", "P", "H" or "A" is responded (the character transmitted by the host is returned).
6	Tens digit of function number (ASCII)		} The function number is designated in a two-digit number. (The number sent by the host is returned.)
7	Units digit of function number (ASCII)		
8	Special additional data (ASCII)		← Space (20H) or "-" (2DH)
9	First character of data / space (ASCII)		} The data sent by the host is returned in normal response, or an error code is returned upon an error.
10	Second character of data / space (ASCII)		
11	Third character of data / tens digit of error code (ASCII)		
12	Fourth character of data / units digit of error code (ASCII)		
13	End-of-text character (ETX)		← Fixed to 03H
14	Upper digit of checksum (ASCII)		} From tens digit of the station address to ETX are added in a binary and the lower two digits of it in hexadecimal notation are stored in ASCII as a checksum.
15	Lower digit of checksum (ASCII)		

9-4-6 Short Frame

Short frames are prepared for special functions to reduce the data transmission time.

(1) Selecting

Host → Inverter (selecting)

	7(6)	0	
0	Start-of-heading character (SOH)		← Fixed to 01H
1	Tens digit of station address (ASCII)	}	Designate a station address of the destination inverter with 01 to 31 or 99. (Designation of each character in ASCII)
2	Units digit of station address (ASCII)		
3	Enquiry character (ENQ)		← Fixed to 05H
4	Command type character (ASCII)		← "a", "e", "f" or "m" is designated.
5	First character of data (ASCII)	}	The data corresponding to the function is converted into a four-digit hexadecimal and each digit is designated in ASCII.
6	Second character of data (ASCII)		
7	Third character of data (ASCII)		
8	Fourth character of data (ASCII)		
9	End-of-text character (ETX)		← Fixed to 03H
10	Upper digit of checksum (ASCII)	}	From tens digit of the station address to ETX are added in a binary and the lower two digits of it in hexadecimal notation are stored in ASCII as a checksum.
11	Lower digit of checksum (ASCII)		

Inverter → Host frame (selecting)

	7(6)	0	
0	Start-of-heading character (SOH)		← Fixed to 01H
1	Tens digit of station address (ASCII)	}	Station address of responding inverter (01 to 31) (designation of each digit in ASCII)
2	Units digit of station address (ASCII)		
3	Response character (ACK/NAK)		← 06H: Normal response (ACK), 15H: Faulty response (NAK)
4	Command type character (ASCII)		← "a", "e", "f" or "m" sent from the host is returned.
5	End-of-text character (ETX)		← Fixed to 03H
6	Upper digit of checksum (ASCII)	}	From tens digit of the station address to ETX are added in a binary and the lower two digits of it in hexadecimal notation are stored in ASCII as a checksum.
7	Lower digit of checksum (ASCII)		

(2) Polling

Host → Inverter (polling)

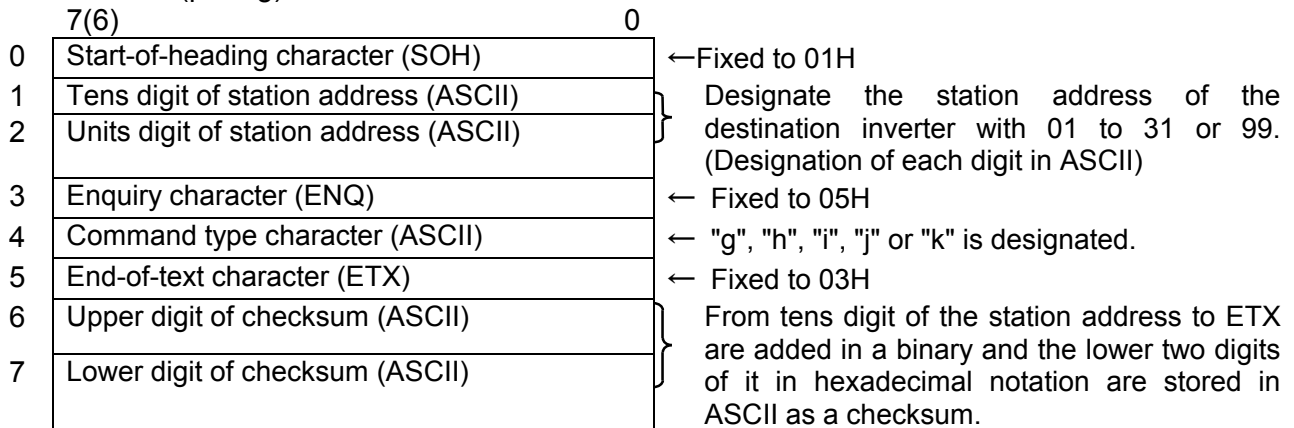

Inverter → Host frame (polling)

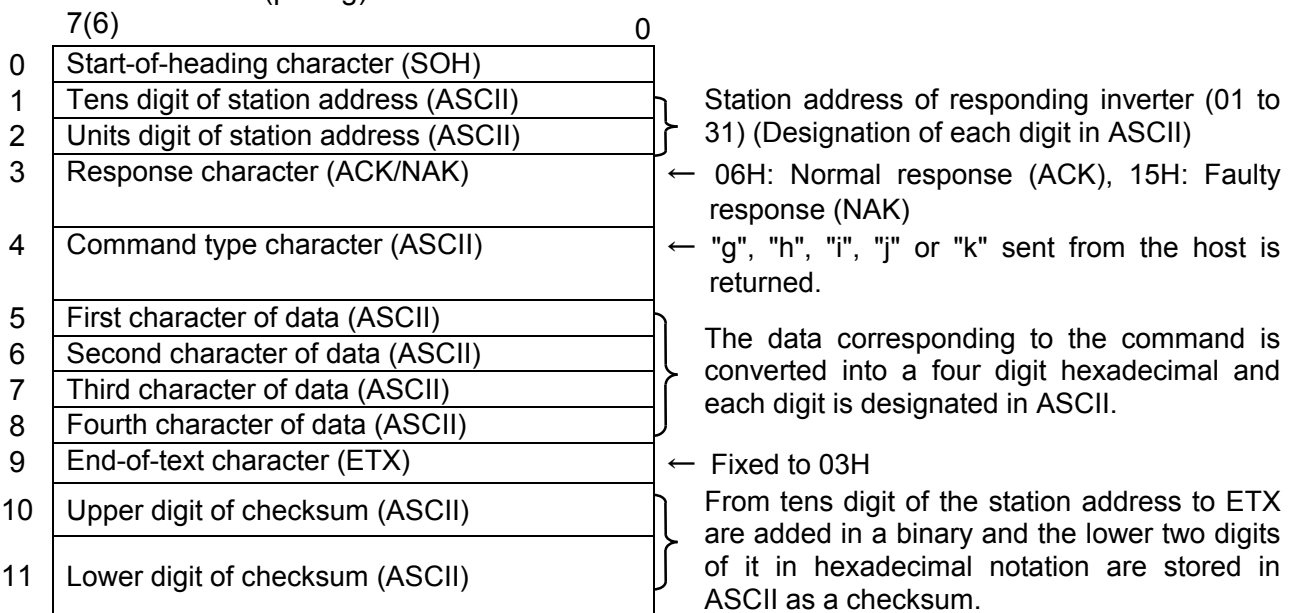

9-4-7 Details of Frame

(1) Start-of-heading character (ASCII; SOH)
01H in binary.

(2) Tens digit and units digit of station address

Two ASCII characters expressing a decimal station address between 1 and 31.

Example: Station address 1: Tens digit of station address: ASCII "0", units digit of station address:

ASCII "1"

Station address 31: Tens digit of station address: ASCII "3", units digit of station address: ASCII "1"

(3) Enquiry character (ASCII; ENQ)
05H in binary.

(4) Response character (ASCII; ACK/NAK)

The inverter sets ACK (06H) to recognize a request.

NAK (15H) is set when the request from the host includes a logical error.

(5) Command type character

In a standard frame, set "R" in ASCII for a polling (reading) request, or set "W" in ASCII for a selecting (writing) request. Set "E" in ASCII for a resetting command. Only the upper case characters are valid.

In a short frame, the function is directly designated using a command type character. Refer to (3) Short Frame in section 9-4-11 Function Code List for details.

(6) Function type character and tens digit and units digit of function number

A request function is designated in three characters. Refer to section 9-4-11 Function Code List for details.

(7) Special additional data

This is normally a space (20H). In a response frame issued by an inverter to request for frequency monitor (M09), a minus sign is set in ASCII during reverse rotation output.

(8) Data

In a selecting (writing) request frame sent from the host to an inverter, designate writing data. Refer to section 9-4-10 Data Type. In a polling (reading) frame, set space or arbitrary letter or number character. In a selecting response frame sent from an inverter to the host, data "0000" or an error code is contained, and in a polling frame, data or an error code is contained.

(9) End-of-text character (ASCII; ETX)

03H in binary.

(10) Upper digit and lower digit of checksum

A binary sum of all the characters from tens digit of the station address to the end-of-text character is obtained and the lower two digits of it in hexadecimal notation are expressed in ASCII codes. Set in the upper case.

Example. When the binary sum is "17EH" → The upper digit of the checksum is "7" in ASCII. The lower digit of the checksum is "E" in ASCII.

9-4-8 Broadcasting

An operation command or frequency command destined to station address "99" is received and processed by all the inverters as broadcasting. However, no response is issued by the inverters.

9-4-9 Communication Error Code

The inverter detects the following errors. The error code is in hexadecimal notation.

Table 9-4-4 Communication error code

Error code (hexadecimal)	Name of error	Description
47H	Checksum error	The checksum of the frame sent to the own station is in discrepancy.
48H	Parity error	The parity is in discrepancy.
49H	Others	Reception error other than above (framing, overrun)
4AH	Format error	The enquiry character or the end-of-text character in the transmitted frame is in an incorrect position.
4BH	Command error	A code other than designated commands (standard and option) is sent.
4EH	Function code error	A request for an unknown function code is issued.
4FH	Write disable	A write prohibited function or in-operation write prohibited function is written during operation.
50H	Data error	Data exceeding the standard range is written.

The inverter does not return NAK in response to errors 47 through 49 above. It issues no response. In the case of errors 4A through 50, an NAK response with an NAK code in the response character field and the two digit hexadecimal error code in the data field is returned.

The latest error can be referred to using the transmission error end code monitor (M26).

9-4-10 Data Type

(1) In the case of value data

16 bit data is expressed in a hexadecimal and set using four ASCII codes. Concretely speaking, the data is between "0000" and "FFFF".

Decimal fractions are weighted into integers. Refer to the corresponding section because the weight varies according to each piece of function data. In some functions, the negative value is expressed in two's complement.

The bit data is converted into the hexadecimal and expressed.

The acknowledgement sent from the inverter in response to a selecting (writing) request is the writing data. In the negative acknowledgement, the error code is returned in two hexadecimal characters.

Set "0000" or an arbitrary letters and numbers in the data to be transmitted to the inverter in a polling (reading) frame.

Example: Frequency data, weight 100 times

120.00Hz $120 \times 100 = 12000 = 2EE0H$

The data is "2" in ASCII, "E" in ASCII, "E" in ASCII and "0" in ASCII in order from the first character to the fourth character.

Acceleration time data, weight 10 times

6.5 sec: $6.5 \times 10 = 65 = 41H$

The data is "0" in ASCII, "0" in ASCII, "4" in ASCII and "1" in ASCII in order from the first character to the fourth character.

(2) In the case of bit data

For bit type data requested by S06, M13 or other functions, the bit data is expressed in hexadecimal notation and each digit is transmitted in ASCII codes.

Example: S06 with FWD (bit 0) ON, X1 (bit 2) ON, and X3 (bit 4) ON

Bit data = 0000 0000 0001 0101 → 0015H → 30H 30H 31H 35H
 (Hexadecimal) (ASCII)

9-4-11 Function Code List

The function code includes the function codes indicated in chapter 5 "Selecting Functions" and the following functions for the standard and short frames.

(1) Functions for standard frame (command data)

Table 9-4-5 Standard frame (command data)

Name	Command type	Function type character and number	Data and operation
Reset command	E	3 spaces	Space is transmitted in the data field. The function resets a protective operation (tripping).
Frequency and speed command	R/W	S01	$\pm 20000d/f_{max}$ (Max. frequency)
Frequency command	R/W	S05	0.00 to 400.00 Hz / 0 to 40000 (100 times value) The inverter operates at the maximum frequency even if a value larger than the maximum frequency is set by function code F03. A communication command is read in the reading mode.
Operation command	R/W	S06	bit15:RESET 1:ON,0:OFF bits 14 to 7: Fixed to 0 bit6:X5 1:ON,0:OFF bit5:X4 1:ON,0:OFF bit4:X3 1:ON,0:OFF bit3:X2 1:ON,0:OFF bit2:X1 1:ON,0:OFF bit 1: REV (reverse rotation command) 1:ON,0:OFF bit 0: FWD (forward rotation command) 1:ON,0:OFF X1, X2, X3, X4 and X5 function according to function code E01 to E05 settings.
Acceleration time 1	R/W	S08	0.0~3600.0s/0~36000 (Value multiplied by 10)
Deceleration time 1	R/W	S09	0.0~3600.0s/0~36000 (Value multiplied by 10)
Torque limit level 1	R/W	S10	100% (rated torque) / + 10000 (Value multiplied by 100)
Torque limit level 2	R/W	S11	100% (rated torque) / + 10000 (Value multiplied by 100)

Notes)

- 1) Negative values are set in 2's complements.
- 2) When reading S01 or S05, the data commanded via communication is read out instead of the command value in the actual operation. To read the actual command value, read the monitor data.
- 3) If both S01 and S05 are designated (written with data other than zero), the S01 command is effective.
- 4) For the alarm input, "0" indicates a failure.
- 5) X1 through X5 are used for general purpose inputs; set the function of each terminal using the general input terminal setting of the inverter.
- 6) To cancel the torque limit of S10 and S11, send 7FFFH.

(2) Functions for standard frame (monitor data)

Table 9-4-6 Standard frame (monitor data)

Name	Command type character	Function type character and number	Data and operation
Frequency (Final value)	R	M01	$\pm 20000d/f_{max}$ (Max. frequency)
Frequency command value	R	M05	100=1.00Hz (Value multiplied by 100) The current frequency setting is returned.
Calculated torque value	R	M07	100% (rated torque) / ± 10000 (value multiplied by 100)
Torque current	R	M08	100% (rated current) / ± 10000 (value multiplied by 100)
Output frequency	R	M09	100=1.00Hz (Value multiplied by 100; special additional data: sign) The current output frequency is returned.
Motor output (power consumption)	R	M10	100% (rated output) / ± 10000 (value multiplied by 100)
Output current	R	M11	100 = 1% of rated inverter current The current output current is returned in the ratio to the rated current.
Output voltage	R	M12	10=1V
Operation command	R	M13	bit15:RESET 1:ON,0:OFF bits 14 to 5: Fixed to 0 bit6:X5 1:ON, 0:OFF bit5:X4 1:ON, 0:OFF bit4:X3 1:ON, 0:OFF bit3:X2 1:ON, 0:OFF bit2:X1 1:ON, 0:OFF bit 1: REV (reverse rotation command) 1:ON,0:OFF bit 0: FWD (forward rotation command) 1:ON,0:OFF The final command value including the state of the actual control terminal of the inverter is returned.
Operation status	R	M14	bit 15: Function code data being written bit 12: 1: Communication valid bit 11: 1: Batch failure (tripping) bit 10: 1: During deceleration bit 9: 1: During acceleration bit 8: 1: Current limit operation bit 7: 1: Voltage limit operation bit 6: 1: Torque limit operation bit 5: 1: DC link voltage established bit 4: 1: During braking bit 3: 1: During output shutoff bit 2: 1: During DC braking bit 1: 1: During reverse rotation bit 0: 1: During forward rotation
General purpose output terminal	R	M15	bit 1: Y2; active upon "1" bit 0: Y1; active upon "1"

Name	Command type character	Function type character and number	Data and operation
Failure description; current one	R	M16	Refer to (4) Alarm display data
Failure description; previous one	R	M17	
Failure description; one before previous one	R	M18	
Failure description; one before two previous ones	R	M19	
Total operation time	R	M20	0 to 65535 / 0 to 65535 hours
DC link voltage monitor	R	M21	0 to 500 / 0 to 500V (200V class) 0 to 1000 / 0 to 1000V (400V class)
Function code	R	M23	4112H = E11S single-phase 200V 4113H = E11S 3-phase 200V 4114H = E11S 3-phase 400V
Capacity code	R	M24	1=0.01kW
ROM version	R	M25	0 to 99: Standard, > 100: Non-standard
Transmission error handling code	R	M26	Refer to section 9-4-9. The latest error is returned. The communication error is initialized when the power is turned off.
Main circuit capacitor life	R	M46	1=0.1%
Cooling fan life	R	M48	1 = 1 hour

Note)

- 1) Output frequency monitoring (M09, M35) adds an ASCII code for forward rotation (space), reverse rotation (minus) and stop (space) as direction of rotation data, and handled as 5-byte data.

(3) Functions for short frame

Table 9-4-7 Short frame

Function	Command type character	Data direction	Data range; transmission data / actual data	Change during operation
Frequency command	a	Selecting	Same as S01	○
Frequency command	e	Selecting	Same as S05	○
Operation command	f	Selecting	Same as S06	○
Reset command	m	Selecting	4 spaces	—
Calculated torque value monitor	h	Polling	Same as M07	—
Torque current monitor	l	Polling	Same as M08	—
Output frequency monitor	j	Polling	Same as M09; no sign is attached.	—
Operation state monitor	k	Polling	Same as M14	—

(4) Alarm display data

The failure description (alarm description) is as shown in the table below. The failure code is in the hexadecimal notation.

Table 9-4-8 Failure description

Failure code	Description	Indication on panel	Failure code	Description	Indication on panel
0000	No alarm	---	0012	External alarm	OH2
0001	Overcurrent, during acceleration	OC1	0016	Braking resistor overheat	dbH
0002	Overcurrent, during deceleration	OC2	0017	Motor 1 overload,	OL1
0003	Overcurrent, during constant speed operation	OC3	0018	Motor 2 overload,	OL2
0006	Overvoltage, during acceleration	OU1	0019	Inverter overload	OLU
0007	Overvoltage, during deceleration	OU2	001F	Memory error	Er1
0008	Overvoltage, during constant speed operation	OU3	0020	Keypad panel communication error	Er2
000A	Undervoltage	LU	0021	CPU error	Er3
000B	Input phase loss	Lin	0025	Output phase loss error	Er7
0011	Heat sink overheat	OH1	0026	RS485 communication error	Er8

9-4-12 Data format

The data format of each piece of function code data of the inverter is defined here. Prepare data according to the format numbered in the data format for each function code. (Refer to section 5-1 Function Setting List and section 9-4-11 Function Code List for the data format.) The data field of the transmission frame except for data format 10 consists of a 4-digit ASCII code converted from a 4-digit hexadecimal data as shown in the figure below. For details of each format, refer to the following data formats (1) through (11).

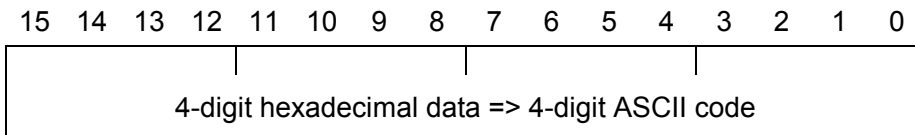

(1) Data format 0

16-bit binary code, least increment 1, positive value only.

Example) In the case that F15: (frequency limiter, upper limit) = 60 Hz

$60 \times 1 = 60$ (dec.) = 003C (hex.), hence: 003C \Rightarrow

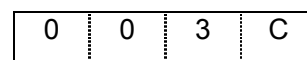

(2) Data format 1

16-bit binary code, least increment 1, positive/negative value
The negative value is expressed in 2's complement. -1 -> FFFF (hex.)

Example: In the case that F18: (bias frequency) = -20 Hz

$-20 \times 1 = -20$ (dec.) = FFEC (hex.), hence: FFEC \Rightarrow

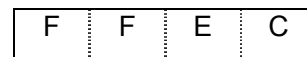

(3) Data format 2

16-bit binary code, least increment 0.1, positive value only

Example) In the case that F17: (gain frequency setting signal) = 100.0%

$100.0 \times 10 = 1000$ (dec.) = 03E8 (hex.), hence: 03E8 \Rightarrow

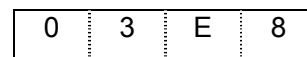

(4) Data format 3

16-bit binary code, least increment 0.1, positive/negative value
The negative value is expressed in 2's complement. -1 -> FFFF (hex.)

Example: In the case that C31: (analog input offset adjustment, terminal 12) = -5.0%

$-5.0 \times 10 = -50$ (dec.) = FFCE (2's complement) \Rightarrow

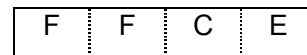

(5) Data format 4

16-bit binary code, least increment 0.01, positive value only

Example) In the case that C05: (multistep frequency 1) = 50.25 Hz

$50.25 \times 100 = 5025$ (dec.) = 13A1 (hex.), hence: 13A1 \Rightarrow

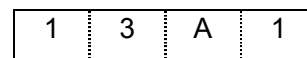

(6) Data format 5

16-bit binary code, least increment 0.01, positive/negative value
The negative data is expressed in 2's complement. -1 -> FFFF (hex.)

Example: In the case that M07: (actual torque) = -85.38%

$-85.38 \times 100 = -8538$ (dec.) = DEA6 (hex.), hence: DEA6 ⇒

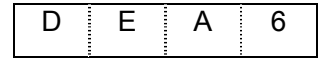

(7) Data format 6

Acceleration/deceleration time, amperage data

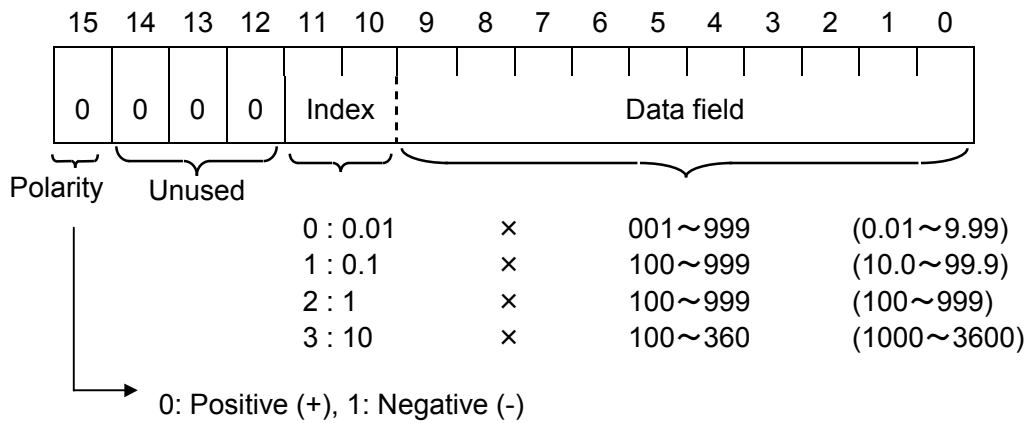

Example: In the case that F07: communication No. (acceleration time 1) = 20.0 seconds

$20.0 = 0.1 \times 200$, hence: 04C8 ⇒

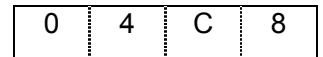

(8) Data format 8

Operation command

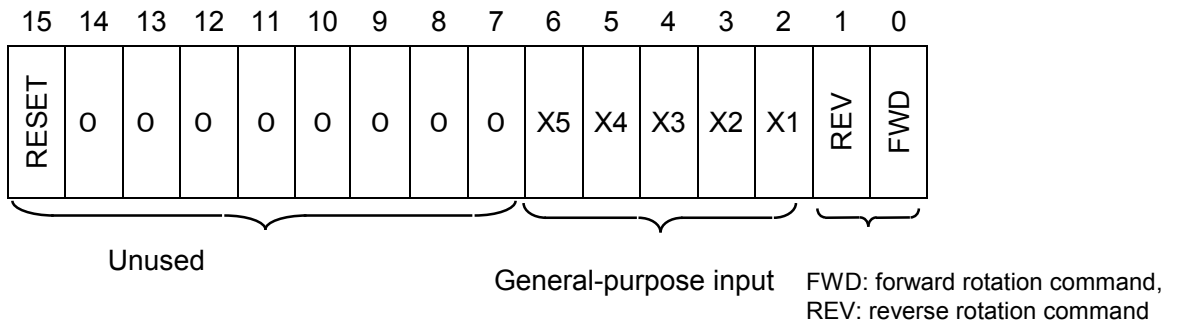

(All bits: "1" when turned on)

Example: In the case that M13: (operation command) = 0000 0000 0100 0101 (bin.): FWD, X1, X5 = ON

M13 = 0045 (hex.), hence: 0045 ⇒

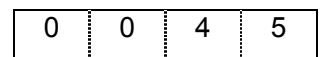

(9) Data format 9

General-purpose output terminal

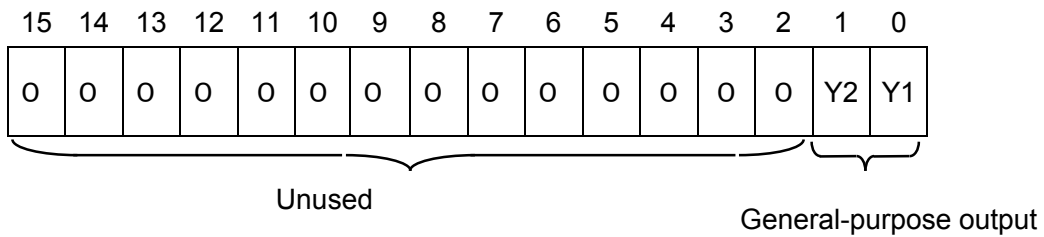

(All bits: "1" when turned on)

Example: In the case that M15: (general-purpose output terminal) = 0000 0000 0000 0001 (bin.): Y1 = ON

M15 = 0001 (hex.), hence: 0001

⇒

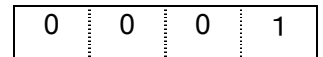

(10) Data format 10

Operation state

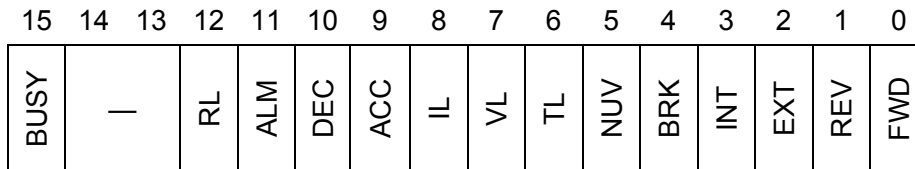

(All bits: "1" when turned on or active)

- FWD: During forward rotation
- REV: During reverse rotation
- EXT: During DC braking
- INT: Inverter shutdown
- BRK: During braking
- NUV: DC link established
- TL: Torque limit operation
- VL: Voltage limit operation
- IL: Current limit operation
- ACC: During acceleration
- DEC: During deceleration
- ALM: Batch alarm
- RL: Transmission valid/invalid
- BUSY: During data writing (processing)

Example) ... Omitted (The monitoring method is similar to format 8.)

10. Options

10-1 External Options

Table 10-1-1 External options

Molded case circuit breaker	The molded case circuit breaker (MCCB) is connected for the protection of the main circuit wiring up to the inverter and for turning the power on and off. The rated current or the rated interrupting capacity varies according to the power supply specifications.
DC reactor (DCR)	<p>Connect in the following cases.</p> <p>(1) When the power supply transformer capacity exceeds 500 kVA.</p> <p>(2) When a thyristor load is connected to the same power supply or when the capacitor for power factor improvement is turned on or off.</p> <p>(3) When the unbalance rate between phases of the source voltage exceeds 2%.</p> $\text{Unbalance rate between phases} = \frac{(\text{Max. voltage [V]} - \text{Min. voltage [V]})}{(\text{Average voltage of three phases [V]})} \times 67 [\%]$ <p>(4) To reduce the harmonic current in the input. The input power factor can be improved to 0.9 to 0.95.</p>
Magnetic contactor (MC)	The inverter can be operated without an electromagnetic contactor. Connect one to turn the power off for the safety after the protective function of the inverter is activated.
Surge absorber	Connect to suppress the surge generated when the electromagnetic contactors, control relays or other exciting coils are opened or closed. S2-A-0 (for electromagnetic contactors), S1-B-0 (for miniature control relays)
Reactor for radio noise reduction	Use for noise reduction when electric noise interference is caused to radios or electronic devices near the inverter.
Frequency setting unit	Connect to set the frequency from the control circuit terminals using the inverter power supply.

11. Applicable Reactor

The DC reactors are recommended to reduce inverter input harmonic current or to correct inverter input power factor.

Table 11-1-1 List of applicable reactor

Applicable inverter model	DC reactor (DCR)
FVR0.1E11S-7EN	DCR2-0.2
FVR0.2E11S-7EN	DCR2-0.4
FVR0.4E11S-7EN	DCR2-0.75
FVR0.75E11S-7EN	DCR2-1.5
FVR1.5E11S-7EN	DCR2-2.2
FVR2.2E11S-7EN	DCR2-3.7
FVR0.4E11S-4EN	DCR4-0.4
FVR0.75E11S-4EN	DCR4-0.75
FVR1.5E11S-4EN	DCR4-1.5
FVR2.2E11S-4EN	DCR4-2.2
FVR4.0E11S-4EN	DCR4-3.7
FVR5.5E11S-4EN	DCR4-5.5
FVR7.5E11S-4EN	DCR4-7.5

Fig. 11-1-1 Connection method of DC reactor (DCR)

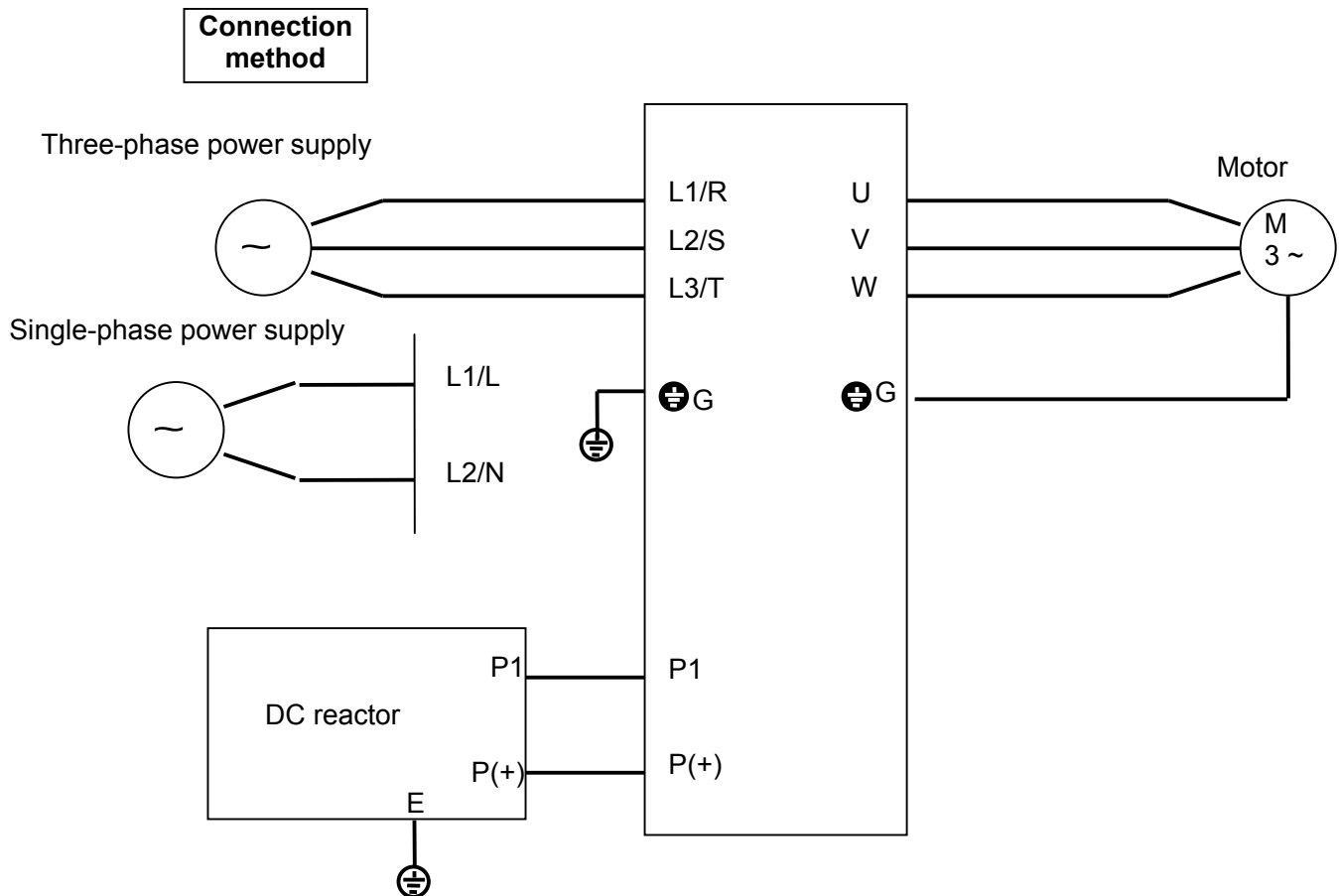

12. Electromagnetic Compatibility (EMC) [Available only inverter for with CE mark]

12-1 General

In accordance with the provisions described in the European Commission Guidelines Document on Council Directive 89/336/EEC, Fuji Electric Co., Ltd. has chosen to classify the FVR-E11S range of inverters as "Complex Components".

Classification as a "Complex Components" allows a product to be treated as an "apparatus", and thus permits compliance with the essential requirements of the EMC Directive to be demonstrated to both an integrator of FVR inverters and to his customer or the installer and the user.

FVR inverters is supplied 'CE-marked', signifying compliance with EC Directive 89/336/EEC when fitted with specified filter units installed and earthed in accordance with this sheet.

This Specification requires the following performance criteria to be met.

EMC product standard **EN61800-3/1997**

Immunity : **Second environment** (Industrial environment)

Emission : **First environment** (Domestic environment)

Finally, it is customer's responsibility to check whether the equipment conforms to EMC directive.

12-2 Recommended Installation Instructions

It is necessary that to conformed to EMC Directive, these instructions must be followed.

Follow the usual safety procedures when working with electrical equipment. All electrical connections to the filter, Inverter and motor must be made by a qualified electrical technician.

- 1) Use the correct filter according to Table 12-2-1.
- 2) Install the Inverter and filter in the electrically shielded metal wiring cabinet.
- 3) The back panel of the wiring cabinet of board should be prepared for the mounting dimensions of the filter. Care should be taken to remove any paint etc. from the mounting holes and face area of the panel. This will ensure the best possible earthing of the filter.
- 4) Use the screened cable for the control , motor and other main wiring which are connected to the inverter, and these screens should be securely earthed.
- 5) It is important that all wire lengths are kept as short as possible and that incoming mains and outgoing motor cables are kept well separated.

" To minimize the conducted radio disturbance in the power distribution system, the length of the motor-cable should be as short as possible. "

Table 12-2-1 RFI filters

Applied Inverter	Filter Type	Rated Current	Max. Rated Voltage	Max. motor cable length	
				EN55011 Class B	EN55011 Class A
FVR0.1E11S-7EN FVR0.2E11S-7EN FVR0.4E11S-7EN	EFL-0.4E11-7	6.5A	1ph 240Vac	10m	50m
FVR0.75E11S-7EN	EFL-0.75E11-7	18A			
FVR1.5E11S-7EN FVR2.2E11S-7EN	EFL-2.2E11-7	29A			
FVR0.4E11S-4EN FVR0.75E11S-4EN	EFL-0.75E11-4	5A	3ph 480Vac		
FVR1.5E11S-4EN FVR2.2E11S-4EN	EFL-2.2E11-4	10A			
FVR4.0E11S-4EN	EFL-4.0E11-4	15A			
FVR5.5E11S-4EN FVR7.5E11S-4EN	EFL-7.5E11-4	30A			

Note : For detail, refer to the instruction manual that came with the RFI filters.

Three-phase power supply

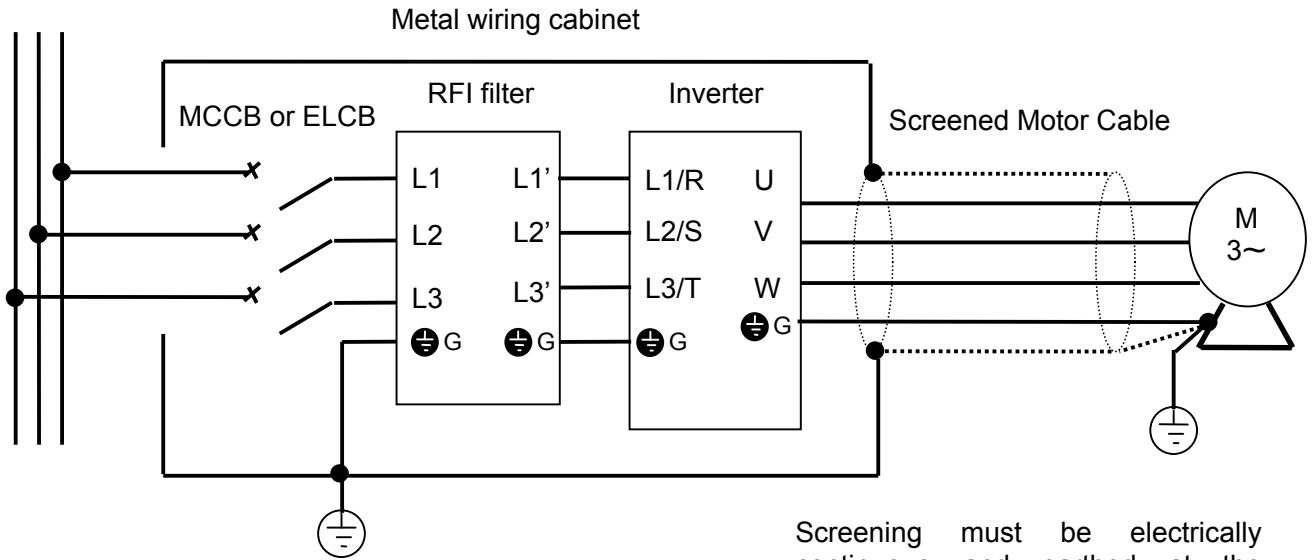

Screening must be electrically continuous and earthed at the cabinet and the motor.

Single-phase power supply

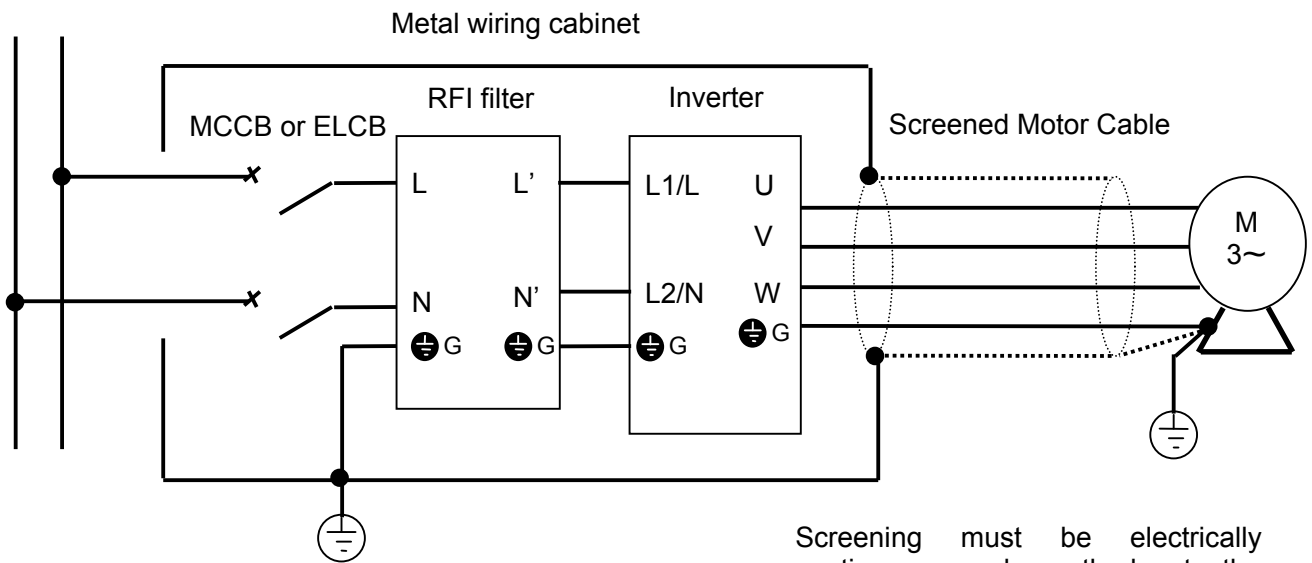

Screening must be electrically continuous and earthed at the cabinet and the motor.

Fig.12-2-1 Recommended installation