

HITACHI INVERTER

SJ700D-3 SERIES

INSTRUCTION MANUAL

Read through this Instruction Manual, and keep it handy for future reference.

NT231X

HITACHI

Introduction

Thank you for purchasing Hitachi SJ700D-3 Series Inverter. This Instruction Manual describes the contents of planning the installation, installing, commissioning, using and servicing the Hitachi SJ700D-3 Series Inverter. Please read this document before operation to perfectly understand proper handling and safety precautions for the product to ensure safety and proper usage. Before attempting installation, operation and maintenance work, you should understand the knowledge of equipment, information of safety, caution and how to use and service the inverter. You should also use the inverter by observing specifications described this guide and prevent risks by performing maintenance.

If you use the inverter with optional products, also you should read the manuals for those products. Note that this instruction manual and the manual for each optional product to be used should be delivered to the end user of the inverter.

Handling of this Instruction Manual (bundled CD)

- The contents of the Instruction Manual are subject to change without prior notice.
- Even if you lose the Instruction Manual, it will not be resupplied, so please keep it carefully.
- No part of the Instruction Manual may be reproduced in any form without the publisher's permission.
- If you find any incorrect description, missing description or have a question concerning the contents of these manuals, please contact the publisher.

Revision History

No.	Revision content	Date of issue	Manual code
1	First edition	April, 2014	NT231X

Safety Instructions

Be sure to read this Quick Reference Guide and appended documents thoroughly before installing, operating, maintaining, or inspecting the inverter. In this Quick Reference Guide, safety instructions are classified into two levels, namely WARNING and CAUTION.

 **WARNING** : Indicates that incorrect handling may cause hazardous situations, which may result in serious personal injury or death.

 **CAUTION** : Indicates that incorrect handling may cause hazardous situations, which may result in moderate or slight personal injury or physical damage alone.

Note that even a  **CAUTION** level situation may lead to a serious consequence according to circumstances. Be sure to follow every safety instruction, which contains important safety information. Also focus on and observe the items and instructions described under "Notes" in the text.

 **CAUTION**

- Many of the drawings in the Quick Reference Guide show the inverter with covers and/or parts blocking your view as removed. Do not operate the inverter in the status shown in those drawings. If you have removed the covers and/or parts, be sure to reinstall them in their original positions before starting operation, and follow all instructions in this Instruction Manual when operating the inverter.

1. Installation

 **CAUTION**

- Install the inverter on a non-flammable surface, e.g., metal. Otherwise, you run the risk of fire.
- Do not place flammable materials near the installed inverter. Otherwise, you run the risk of fire.
- When carrying the inverter, do not hold its top cover. Otherwise, you run the risk of injury by dropping the inverter.
- Prevent foreign matter (e.g., cut pieces of wire, sputtering welding materials, iron chips, wire, and dust) from entering the inverter. Otherwise, you run the risk of fire.
- Install the inverter on a structure able to bear the weight specified in this Instruction Manual. Otherwise, you run the risk of injury due to the inverter falling.
- Install the inverter on a vertical wall that is free of vibrations. Otherwise, you run the risk of injury due to the inverter falling.
- Do not install and operate the inverter if it is damaged or its parts are missing. Otherwise, you run the risk of injury.
- Install the inverter in a well-ventilated indoor site not exposed to direct sunlight. Avoid places where the inverter is exposed to high temperature, high humidity, condensation, dust, explosive gases, corrosive gases, flammable gases, grinding fluid mist, or salt water. Otherwise, you run the risk of fire.
- The inverter is precision equipment. Do not allow it to fall or be subject to high impacts, step on it, or place a heavy load on it. Doing so may cause the inverter to fail.

2. Wiring

 **WARNING**

- Be sure to ground the inverter. Otherwise, you run the risk of electric shock or fire.
- Commit wiring work to a qualified electrician. Otherwise, you run the risk of electric shock or fire.
- Before wiring, make sure that the power supply is off. Otherwise, you run the risk of electric shock or fire.
- Perform wiring only after installing the inverter. Otherwise, you run the risk of electric shock or injury.
- Do not remove rubber bushings from the wiring section. Otherwise, the edges of the wiring cover may damage the wire, resulting in a short circuit or ground fault.

 **CAUTION**

- Make sure that the voltage of AC power supply matches the rated voltage of your inverter. Otherwise, you run the risk of injury or fire.
- Do not input single-phase power into the inverter. Otherwise, you run the risk of fire.
- Do not connect AC power supply to any of the output terminals (U, V, and W). Otherwise, you run the risk of injury or fire.
- Do not connect a resistor directly to any of the DC terminals (PD, P, and N). Otherwise, you run the risk of fire.
- Connect an earth-leakage breaker to the power input circuit. Otherwise, you run the risk of fire.
- Use only the power cables, earth-leakage breaker, and magnetic contactors that have the specified capacity (ratings). Otherwise, you run the risk of fire.
- Do not use the magnetic contactor installed on the primary and secondary sides of the inverter to stop its operation.
- Tighten each screw to the specified torque. No screws must be left loose. Otherwise, you run the risk of fire.
- Before operating, slide switch SW1 in the inverter, be sure to turn off the power supply. Otherwise, you run the risk of electric shock and injury.
- Since the inverter supports two modes of cooling-fan operation, the inverter power is not always off, even when the cooling fan is stopped. Therefore, be sure to confirm that the power supply is off before wiring. Otherwise, you run the risk of electric shock and injury.

3. Operation

 **WARNING**

- While power is supplied to the inverter, do not touch any terminal or internal part of the inverter, check signals, or connect or disconnect any wire or connector. Otherwise, you run the risk of electric shock or fire.
- Be sure to close the terminal block cover before turning on the inverter power. Do not open the terminal block cover while power is being supplied to the inverter or voltage remains inside. Otherwise, you run the risk of electric shock.
- Do not operate switches with wet hands. Otherwise, you run the risk of electric shock.
- While power is supplied to the inverter, do not touch the terminal of the inverter, even if it has stopped. Otherwise, you run the risk of injury or fire.
- If the retry mode has been selected, the inverter will restart suddenly after a break in the tripping status. Stay away from the machine controlled by the inverter when the inverter is under such circumstances. (Design the machine so that human safety can be ensured, even when the inverter restarts suddenly.) Otherwise, you run the risk of injury.
- Do not select the retry mode for controlling an elevating or traveling device because output free-running status occurs in retry mode. Otherwise, you run the risk of injury or damage to the machine controlled by the inverter.
- If an operation command has been input to the inverter before a short-term power failure, the inverter may restart operation after the power recovery. If such a restart may put persons in danger, design a control circuit that disables the inverter from restarting after power recovery. Otherwise, you run the risk of injury.
- The [STOP] key is effective only when its function is enabled by setting. Prepare an emergency stop switch separately. Otherwise, you run the risk of injury.
- If an operation command has been input to the inverter before the inverter enters alarm status, the inverter will restart suddenly when the alarm status is reset. Before resetting the alarm status, make sure that no operation command has been input.
- While power is supplied to the inverter, do not touch any internal part of the inverter or insert a bar in it. Otherwise, you run the risk of electric shock or fire.

 **CAUTION**

- Do not touch the heat sink, which heats up during the inverter operation. Otherwise, you run the risk of burn injury.
- The inverter allows you to easily control the speed of motor or machine operations. Before operating the inverter, confirm the capacity and ratings of the motor or machine controlled by the inverter. Otherwise, you run the risk of injury.
- Install an external brake system if needed. Otherwise, you run the risk of injury.
- When using the inverter to operate a standard motor at a frequency of over 60 Hz, check the allowable motor speeds with the manufacturers of the motor and the machine to be driven and obtain their consent before starting inverter operation. Otherwise, you run the risk of damage to the motor and machine.
- During inverter operation, check the motor for the direction of rotation, abnormal sound, and vibrations. Otherwise, you run the risk of damage to the machine driven by the motor.

4. Maintenance, inspection, and parts replacement

 **WARNING**

- Before inspecting the inverter, be sure to turn off the power supply and wait for 10 minutes or more. Otherwise, you run the risk of electric shock. (Before inspection, confirm that the Charge lamp on the inverter is off and the DC voltage between terminals P and N is 45 V or less.)
- Commit only a designated person to maintenance, inspection, and the replacement of parts. (Be sure to remove wristwatches and metal accessories, e.g., bracelets, before maintenance and inspection work and to use insulated tools for the work.) Otherwise, you run the risk of electric shock and injury.

5. Others

 **WARNING**

- Never modify the inverter. Otherwise, you run the risk of electric shock and injury.

 **CAUTION**

- Do not discard the inverter with household waste. Contact an industrial waste management company in your area who can treat industrial waste without polluting the environment.

Caution for EMC (Electromagnetic Compatibility) (0.4kW-150kW)

The SJ700D series inverter conforms to the requirements of Electromagnetic Compatibility (EMC) Directive (2004/108/EC). However, when using the inverter in Europe, you must comply with the following specifications and requirements to meet the EMC Directive and other standards in Europe:



WARNING: This equipment must be installed, adjusted, and maintained by qualified engineers who have expert knowledge of electric work, inverter operation, and the hazardous circumstances that can occur. Otherwise, personal injury may result.

1. Power supply requirements

- a. Voltage fluctuation must be -15% to +10% or less.
- b. Voltage imbalance must be $\pm 3\%$ or less.
- c. Frequency variation must be $\pm 4\%$ or less.
- d. Total harmonic distortion (THD) of voltage must be $\pm 10\%$ or less.

2. Installation requirement

- a. The integrated filter in the SJ700D series inverter must be enabled. (See chapter 2 Installation and Wiring)
* When using the specific external filter for the SJ700D series inverter, please refer to the instruction described in the dedicated guide book for the filter.

3. Wiring requirements

- a. A shielded wire (screened cable) must be used for motor wiring, and the length of the cable must be according to the following table (Table 1).
- b. The carrier frequency must be set according to the following table to meet an EMC requirement (Table 1).
- c. The main circuit wiring must be separated from the control circuit wiring.

4. Environmental requirements (to be met when a filter is used)

- a. Ambient temperature must be within the range -10°C to $+50^{\circ}\text{C}$.
- b. Relative humidity must be within the range 20% to 90% (non-condensing).
- c. Vibrations must be 5.9 m/s^2 (0.6 G) (10 to 55 Hz) or less. (0.4 to 22kW)
 2.94 m/s^2 (0.3 G) (10 to 55Hz) or less. (30 to 150kW)
- d. The inverter must be installed indoors (not exposed to corrosive gases and dust) at an altitude of 1,000 m or less.

Table 1

model	cat.	cable length(m)	carrier frequency(kHz)	model	cat.	cable length(m)	carrier frequency(kHz)
SJ700D-004L	C3	5	2.5				
SJ700D-007L	C3	5	2.5	SJ700D-007H	C3	5	2.5
SJ700D-015L	C3	5	2.5	SJ700D-015H	C3	5	2.5
SJ700D-022L	C3	5	2.5	SJ700D-022H	C3	5	2.5
SJ700D-037L	C3	5	2.5	SJ700D-037H SJ700D-040H	C3	5	2.5
SJ700D-055L	C3	1	1	SJ700D-055H	C3	1	2.5
SJ700D-075L	C3	1	1	SJ700D-075H	C3	1	2.5
SJ700D-110L	C3	1	1	SJ700D-110H	C3	1	2.5
SJ700D-150L	C3	1	1	SJ700D-150H	C3	1	2.5
SJ700D-185L	C3	1	1	SJ700D-185H	C3	1	2.5
SJ700D-220L	C3	5	2.5	SJ700D-220H	C3	1	2.5
SJ700D-300L	C3	5	2.5	SJ700D-300H	C3	1	2.5
SJ700D-370L	C3	5	2.5	SJ700D-370H	C3	1	2.5
SJ700D-450L	C3	5	2.5	SJ700D-450H	C3	5	2.5
SJ700D-550L	C3	5	2.5	SJ700D-550H	C3	5	2.5
				SJ700D-750H	C3	10	2.5
				SJ700D-900H	C3	10	2.5
				SJ700D-1100H	C3	10	2.5
				SJ700D-1320H SJ700D-1500H	C3	10	2.5

Cautions for UL and cUL (0.4kW-150kW)

(Standard to comply with: UL508C, CSA C22.2 No14-5)

Warning Markings

GENERAL:

These devices are open type and/or Enclosed Type 1 (when employing accessory Type 1 Chassis Kit) AC Inverters with three phase input and three phase output. They are intended to be used in an enclosure. They are used to provide both an adjustable voltage and adjustable frequency to the ac motor. The inverter automatically maintains the required volts-Hz ration allowing the capability through the motor speed range.

- (1) "Use 60/75°C CU wire only" or equivalent.
For models SJ700D series except for models SJ700D-055H, SJ700D-075H, SJ700D-110H.
- (2) "Use 75°C CU wire only" or equivalent.
For models SJ700D series except for SJ700D-075H, SJ700D-110H, SJ700D-055H.
- (3) "Suitable for use on a circuit capable of delivering not more than 100,000rms symmetrical amperes, 240V maximum". For models with suffix L.
- (4) "Suitable for use on a circuit capable of delivering not more than 100,000 rms symmetrical amperes, 480V maximum". For models with suffix H.
- (5) "Install device in pollution degree 2 environment"
- (6) "Maximum Surrounding Air Temperature 45 or 50°C"
- (7) "CAUTION - Risk of Electric Shock - Capacitor discharge time is at least 10 min."
- (8) "Integral solid state short circuit protection does not provide branch circuit protection.
Branch circuit protection must be provided in accordance with the NEC and any additional local codes"
- (9) "Solid State motor overload protection provided in each model".
- (10) Tightening torque and wire range for field wiring terminals are in the table below:

<u>Model No.</u>	<u>Required Torque (N.m)</u>	<u>Wire Range (AWG)</u>
SJ700D-004L	1.8	14(Stranded only)
SJ700D-007L	1.8	14(Stranded only)
SJ700D-015L	1.8	14(Stranded only)
SJ700D-022L	1.8	14(Stranded only)
SJ700D-037L	1.8	10(Stranded only)
SJ700D-050L	3.0	8
SJ700D-055L	4.0	8
SJ700D-075L	4.0	6
SJ700D-110L	4.0	6-4
SJ700D-150L	4.9	2
SJ700D-185L	4.9	1
SJ700D-220L	8.8	1 or 1/0
SJ700D-300L	8.8	2/0 or Parallel of 1/0
SJ700D-370L	20.0	4/0 (Prepared wire only) or Parallel of 1/0
SJ700D-450L	20.0	4/0 (Prepared wire only) or Parallel of 1/0
SJ700D-550L	19.6	350 kcmil (Prepared wire only) or Parallel of 2/0 (Prepared wire only)

<u>Model No.</u>	<u>Required Torque (N.m)</u>	<u>Wire Range (AWG)</u>
SJ700D-007H	1.8	14(Stranded only)
SJ700D-015H	1.8	14(Stranded only)
SJ700D-022H	1.8	14(Stranded only)
SJ700D-037H	1.8	14(Stranded only)
SJ700D-040H	1.8	14(Stranded only)
SJ700D-055H	4.0	12
SJ700D-075H	4.0	10
SJ700D-110H	4.0	8
SJ700D-150H	4.9	6
SJ700D-185H	4.9	6
SJ700D-220H	4.9	6 or 4
SJ700D-300H	4.9	3
SJ700D-370H	20.0	1
SJ700D-450H	20.0	1
SJ700D-550H	20.0	2/0
SJ700D-750H	20.0	Parallel of 1/0
SJ700D-900H	20.0	Parallel of 1/0
SJ700D-1100H	35.0	Parallel of 3/0
SJ700D-1320H	35.0	Parallel of 3/0
SJ700D-1500H	35.0	Parallel of 3/0

- (11) Distribution fuse / circuit breaker size marking is included in the manual to indicate that the unit shall be connected with a listed inverse time circuit breaker, rated 600 V with the current ratings as shown in the table below:

<u>Model No.</u>	<u>Fuse Size (Maximum A)</u>		<u>Circuit Breaker (Maximum A)</u>	
	<u>Type</u>	<u>Rating</u>	<u>Type</u>	<u>Rating</u>
SJ700D-004L	J	30 A	-	-
SJ700D-007L	J	30 A	-	-
SJ700D-015L	J	30 A	-	-
SJ700D-022L	J	30 A	-	-
SJ700D-037L	J	30 A	-	-
SJ700D-050L	J	30 A	-	-
SJ700D-055L	J	100 A	Inverse time	100 A
SJ700D-075L	J	100 A	Inverse time	100 A
SJ700D-110L	J	100 A	Inverse time	100 A
SJ700D-150L	J	125 A	Inverse time	125 A
SJ700D-185L	J	125 A	Inverse time	125 A
SJ700D-220L	J	125 A	Inverse time	225 A
SJ700D-300L	J	225 A	Inverse time	225 A
SJ700D-370L	J	225 A	Inverse time	225 A
SJ700D-450L	J	250 A	Inverse time	250 A
SJ700D-550L	J	300 A	Inverse time	300 A

Model No.	Fuse Size (Maximum A)		Circuit Breaker (Maximum A)	
	Type	Rating	Type	Rating
SJ700D-007H	J	20 A	-	-
SJ700D-015H	J	20 A	-	-
SJ700D-022H	J	20 A	-	-
SJ700D-037H	J	20 A	-	-
SJ700D-040H	J	20 A	-	-
SJ700D-055H	J	40 A	Inverse time	40 A
SJ700D-075H	J	40 A	Inverse time	40 A
SJ700D-110H	J	40 A	Inverse time	40 A
SJ700D-150H	J	75 A	Inverse time	75 A
SJ700D-185H	J	75 A	Inverse time	75 A
SJ700D-220H	J	75 A	Inverse time	75 A
SJ700D-300H	J	100 A	Inverse time	100 A
SJ700D-370H	J	100 A	Inverse time	100 A
SJ700D-450H	J	150 A	Inverse time	150 A
SJ700D-550H	J	150 A	Inverse time	150 A
SJ700D-750H	J	225 A	Inverse time	225 A
SJ700D-900H	J	225 A	Inverse time	225 A
SJ700D-1100H	J	300 A	Inverse time	300 A
SJ700D-1320H	J	350 A	Inverse time	350 A
SJ700D-1500H	J	350 A	Inverse time	350 A

Note) Please select an appropriate fuse or an appropriate circuit breaker for a system.

- (12) “Field wiring connection must be made by a UL Listed and CN closed-loop terminal connector sized for the wire gauge involved. Connector must be fixed using the crimp tool specified by the connector manufacturer.”
- (13) “Motor over temperature protection is not provided by the drive.”

DANGER! RISQUE DE BLESSURE OU DE CHOC ELECTRIQUE

- Lire attentivement le manuel avant l’installation et suivre les instructions
- Avant d’intervenir dans le variateur, couper le circuit de puissance et attendre 10 minutes avant d’ouvrir le capot

The Hitachi SJ700D-3 series succeed the SJ700-2 series with the additional and enhanced features.

The table below is a belief summary of the major improved features.

Subject	SJ700-2	SJ700D-3	Point!
Dual rating Constant torque/ Variable torque	N/A	Selectable	If the inverter drives the light load application (e.g. fan pump application), you can choose the one size smaller capacity inverter than the motor capacity, which allows you to reduce the total cost of your system.
Easy sequence (EzSQ) – Drive program function	Process with 1 task.	Supporting 5 tasks processing with improved user friendliness.	The inverter processes 5 tasks at the same time, which allows you to realize 5 times faster EzSQ processing in maximum.
Optional LCD Operator	SRW operator (2-line LCD) WOP operator (2-line LCD)	Full compatibility with WOP operator (5-line LCD and multi-language)	WOP, the optional LCD Operator, provides several user friendliness; -Multi data monitoring -Parameter configuration as monitoring data -Parameter / Program copy -Multi-language display
RS-485 serial communications	19.2kbps (maximum)	115.2kbps (maximum), and so on.	Approx. 6 times faster communication in comparison with the former model are supported. In addition, some communication commands are newly supported.
Initialization	After setting b084 (initialization selection), press some keys.	In addition to the conventional method, executing initialization by a parameter is possible. (Select b084 and b180=01 : enable the initializing)	You can initialize easily only by setting the parameter and no special procedure is required
Phase loss protection	Input phase loss protection	Input phase loss protection Output phase loss protection	Protection function expands to not only input side but output side, which provides more reliable protection against the phase loss.

Chapter 1 Overview

1.1	Inspection of the Purchased Product	1 - 1
1.1.1	Inspecting the product	1 - 1
1.1.2	Instruction manual (this manual)	1 - 1
1.2	Method of Inquiry and Product Warranty	1 - 2
1.2.1	Method of inquiry	1 - 2
1.2.2	Product warranty	1 - 2
1.2.3	Warranty Terms	1 - 2
1.3	Exterior Views and Names of Parts	1 - 3

Chapter 2 Installation and Wiring

2.1	Installation	2 - 1
2.1.1	Precautions for installation	2 - 2
2.1.2	Backing plate	2 - 4
2.2	Wiring	2 - 5
2.2.1	Terminal connection diagram and explanation of terminals and switch settings	2 - 6
2.2.2	Wiring of the main circuit	2 - 11
2.2.3	Wiring of the control circuit	2 - 21
2.2.4	Wiring of the digital operator	2 - 22
2.2.5	Selection and wiring of regenerative braking resistor (on 5.5 kW to 22 kW models)	2 - 23

Chapter 3 Operation

3.1	Operating Methods	3 - 1
3.2	How To Operate the Digital Operator	3 - 3
3.2.1	Names and functions of components	3 - 3
3.2.2	Code display system and key operations	3 - 4
3.3	How To Make a Test Run	3 - 10
3.4	Example of I/O connections	3 - 13
3.5	Basic Parameter Setting to Drive Motor	3 - 17
3.5.1	Setting Frequency command source and Run command source	3 - 17
3.5.2	Frequency command source selection	3 - 18
3.5.3	Run command source selection	3 - 20
3.6	Duan rating selection	3 - 22

Chapter 4 Explanation of Functions

4.1	Monitor Mode	4 - 1
4.1.1	Output frequency monitoring (d001)	4 - 1
4.1.2	Output current monitoring (d002)	4 - 1
4.1.3	Rotation direction monitoring (d003)	4 - 1
4.1.4	Process variable (PV), PID feedback monitoring (d004, A071, A075)	4 - 1
4.1.5	Intelligent input terminal status (d005)	4 - 2
4.1.6	Intelligent output terminal status (d006)	4 - 2
4.1.7	Scaled output frequency monitoring (d007, b086)	4 - 2
4.1.8	Actual-frequency monitoring d008, P011, H004, H204)	4 - 3
4.1.9	Torque command monitoring (d009, P033, P034)	4 - 3
4.1.10	Torque bias monitoring (d010, P036 to P038)	4 - 3

4.1.11	Torque monitoring (d012)	4 - 3
4.1.12	Output voltage monitoring (d013)	4 - 3
4.1.13	Power monitoring (d014)	4 - 3
4.1.14	Cumulative power monitoring (d015, b078, b079)	4 - 4
4.1.15	Cumulative operation RUN time monitoring (d016)	4 - 4
4.1.16	Cumulative power-on time monitoring (d017)	4 - 4
4.1.17	Heat sink temperature monitoring (d018)	4 - 4
4.1.18	Motor temperature monitoring (d019, b98)	4 - 4
4.1.19	Life-check monitoring (d022)	4 - 4
4.1.20	Program counter display (easy sequence function) (d023)	4 - 5
4.1.21	Program number monitoring (easy sequence function) (d024)	4 - 5
4.1.22	User monitors 0 to 2 (easy sequence function)(d025 to d027)	4 - 5
4.1.23	Pulse counter monitor(d028)	4 - 5
4.1.24	Position command monitor (in absolute position control mode)(d029)	4 - 5
4.1.25	Current position monitor (in absolute position control mode)(d030)	4 - 5
4.1.26	Inverter modemonitor (d060)	4 - 5
4.1.27	Trip Counter (d080)	4 - 5
4.1.28	Trip monitoring 1 to 6 (d081, d082 to d086)	4 - 6
4.1.29	Programming error monitoring (d090)	4 - 6
4.1.30	DC voltage monitoring (d102)	4 - 6
4.1.31	BRD load factor monitoring (d103, b090)	4 - 6
4.1.32	Electronic thermal overload monitoring (d104)	4 - 6
4.2	Function Mode	4 - 7
4.2.1	Output frequency setting (F001, A001, A020, C001 to C008)	4 - 7
4.2.2	Keypad Run key routing (F004)	4 - 7
4.2.3	Rotational direction restriction (b035)	4 - 7
4.2.4	Frequency source setting (A001)	4 - 8
4.2.5	Run command source setting (A002, C001 to C008, C019, F004)	4 - 8
4.2.6	Stop mode selection (b091, F003, b003, b007, b088)	4 - 9
4.2.7	STOP key enable (b087)	4 - 9
4.2.8	Acceleration/deceleration time setting (F002, F003, A004, P031, C001 to C008)	4 - 10
4.2.9	Base frequency setting (A003, A081, A082)	4 - 11
4.2.10	Maximum frequency setting (A004)	4 - 11
4.2.11	External analog input setting (O, O2, and OI) (A005, A006, C001 to C008)	4 - 12
4.2.12	Frequency operation function (A141 to A143, A001, A076)	4 - 13
4.2.13	Frequency addition function (A145, A046, C001 to C008)	4 - 14
4.2.14	Start/end frequency setting for external analog input (A011 to A015, A101 to A105, A111 to A114)	4 - 14
4.2.15	External analog input (O/OI/O2) filter setting (A016)	4 - 15
4.2.16	V/f gain setting (A045, A082)	4 - 15
4.2.17	V/F characteristic curve selection (A044, b100, b101)	4 - 16
4.2.18	Torque boost setting (A041, A042, A043, H003, H004)	4 - 18
4.2.19	DC braking (DB) setting (A051 to A059, C001 to C008)	4 - 20
4.2.20	Frequency upper limit setting (A061, A062)	4 - 24
4.2.21	Jump frequency function (A063 to A068)	4 - 25
4.2.22	Acceleration stop frequency setting (A069, A070, A097)	4 - 25
4.2.23	PID function (A001, A005, A071 to A076, d004, C001 to C008, C021 to C025, C044)	4 - 26
4.2.24	Two-stage acceleration/deceleration function (2CH) (F002, F003, A092 to A096, C001 to C008)	4 - 30
4.2.25	Acceleration/deceleration curve selection (A097, A098, A131, A132)	4 - 31
4.2.26	Energy-saver operation (A085, A086)	4 - 32
4.2.27	Retry or trip after instantaneous power failure (b001 to b005, b007, b008, C021 to C026)	4 - 33

4.2.28	Input/Output phase loss power protection (b006 / b141,b142)	4 - 36
4.2.29	Electronic thermal protection (b012, b013, b015, b016, C021 to C026, C061)	4 - 37
4.2.30	Overload restriction/overload notice (b021 to b026, C001 to C008, C021 to C026, C040, C041, C111)	4 - 40
4.2.31	Overcurrent restraint (b027)	4 - 40
4.2.32	Overvoltage suppression during deceleration (b130 to b134)	4 - 41
4.2.33	Start frequency setting (b082)	4 - 42
4.2.34	Reduced voltage start function (b036, b082)	4 - 42
4.2.35	Carrier frequency setting	4 - 43
4.2.36	Automatic carrier frequency reduction	4 - 44
4.2.37	Dynamic braking (BRD) function (b090, b095, b096)	4 - 45
4.2.38	Cooling-fan operation setting (b092)	4 - 45
4.2.39	Intelligent input terminal setting (SET, SET3) (C001 to C008)	4 - 46
4.2.40	Input terminal a/b (NO/NC) selection (C011 to C018, C019)	4 - 47
4.2.41	Multispeed select setting (CF1 to CF4 and SF1 to SF7) (A019, A020 to A035, C001 to C008)	4 - 47
4.2.42	Jogging (JG) command setting (A038, A039, C001 to C008)	4 - 49
4.2.43	2nd/3rd motor control function (SET and SET3)	4 - 50
4.2.44	Software lock (SFT) function (b031, C001 to C008)	4 - 51
4.2.45	Forcible-operation from digital operation (OPE) function (A001, A002, C001 to C008)	4 - 51
4.2.46	Forcible-operation from terminal (F-TM) function (A001, A002, C001 to C008)	4 - 51
4.2.47	Free-run stop (FRS) function (b088, b033, b007, b028 to b030, C001 to C008)	4 - 52
4.2.48	Commercial power source switching (CS) function (b003, b007, C001 to C008)	4 - 53
4.2.49	Reset (RS) function (b003, b007, C102, C103, C001 to C008)	4 - 54
4.2.50	Unattended start protection (USP) function (C001 to C008)	4 - 56
4.2.51	Remote control function (UP and DWN) (C101, C001 to C008)	4 - 56
4.2.52	External trip (EXT) function (C001 to C008)	4 - 57
4.2.53	3-wire interface operation function (STA, STP, and F/R) (C001 to C008)	4 - 57
4.2.54	Control gain switching function (CAS) (A044, C001 to C008, H005, H050 to H052, H070 to H072)	4 - 58
4.2.55	P/PI switching function (PPI) (A044, C001 to C008, H005, H050 to H052, H070 to H072)	4 - 58
4.2.56	Analog command holding function (AHD) (C001 to C008)	4 - 59
4.2.57	Intelligent pulse counter (PCNT and PCC)	4 - 59
4.2.58	Intelligent output terminal setting (C021 to C026)	4 - 60
4.2.59	Intelligent output terminal a/b (NO/NC) selection (C031 to C036)	4 - 61
4.2.60	Running signal (RUN) (C021 to C025)	4 - 62
4.2.61	Frequency arrival signals (FA1, FA2, FA3, FA4, and FA5) (C021 to C025, C042, C043, C045, C046)	4 - 62
4.2.62	Running time over and power-on time over signals (RNT and ONT) (b034, C021 to C026, d016, d017)	4 - 64
4.2.63	0 Hz speed detection signal (ZS) (A044, C021 to C025, C063)	4 - 64
4.2.64	Over-torque signal (OTQ) (A044, C021 to C025, C055 to C058)	4 - 65
4.2.65	Alarm code output function (AC0 to AC3) (C021 to C025, C062)	4 - 65
4.2.66	Logical output signal operation function (LOG1 to LOG6) (C021 to C026, C142 to C159)	4 - 66
4.2.67	Capacitor life warning signal (WAC) (C021 to C026)	4 - 67
4.2.68	Communication line disconnection signal (NDc) (C021 to C026, C077)	4 - 67
4.2.69	Cooling-fan speed drop signal (WAF) (C021 to C026, b092 to d022)	4 - 68
4.2.70	Starting contact signal (FR) (C021 to C026)	4 - 68
4.2.71	Heat sink overheat warning signal (OHF) (C021 to C026, C064)	4 - 68

4.2.72	Low-current indication (LOC) signal (C021 to C026, C038, C039).....	4 - 69
4.2.73	Inverter ready signal (IRDY) (C021 to C026)	4 - 69
4.2.74	Forward rotation signal (FWR) (C021 to C026).....	4 - 69
4.2.75	Reverse rotation signal (RVR) (C021 to C026)	4 - 70
4.2.76	Major failure signal (MJA) (C021 to C026)	4 - 70
4.2.77	Window comparators (WCO/WCO1/WCO2) (detection of terminal disconnection: ODC/OIDc/O2Dc)4 - 71	
4.2.78	Output signal delay/hold function (C130 to C141)	4 - 72
4.2.79	Input terminal response time	4 - 72
4.2.80	External thermistor function (TH) (b098, b099, C085).....	4 - 72
4.2.81	FM terminal (C027, b081)	4 - 73
4.2.82	AM and AMI terminals (C028, C029, C106, C108 to C110)	4 - 74
4.2.83	Initialization setting (b084, b085)	4 - 75
4.2.84	Function code display restriction (b037, U001 to U012).....	4 - 76
4.2.85	Initial-screen selection (selection of the initial screen to be displayed after power-on) (b038)	4 - 78
4.2.86	Automatic user-parameter setting (b039, U001 to U012)	4 - 79
4.2.87	Stabilization constant setting (H006)	4 - 79
4.2.88	Selection of operation at option board error (P001, P002)	4 - 79
4.2.89	Optimum accel/decel operation function (A044, A085, b021, b022)	4 - 80
4.2.90	Brake control function (b120 to b127, C001 to C008, C021, C025).....	4 - 81
4.2.91	Deceleration and stopping at power failure (nonstop deceleration at instantaneous power failure) (b050 to b054)	4 - 83
4.2.92	Offline auto-tuning function (H001 to H004, H030 to H034, A003, A051, A082)	4 - 85
4.2.93	Online auto-tuning function.....	4 - 87
4.2.94	Secondary resistance compensation (temperature compensation) function (P025, b098)	4 - 88
4.2.95	Motor constants selection	4 - 88
4.2.96	Sensorless vector control (A001, A044, F001, b040 to b044, H002 to H005, H020 to H024,H050 to H052)	4 - 90
4.2.97	Sensorless vector, 0 Hz domain control (A001, A044, F001, b040 to b044, H002 to H005, H020to H024, H050 to H052, H060, H061)	4 - 91
4.2.98	Torque monitoring function (A044, C027 to C029, H003, H004)	4 - 92
4.2.99	Forcing function (FOC) (A044, C001 to C008).....	4 - 92
4.2.100	Torque limitation function (A044, b040 to b044, C001 to C008, C021 to C025).....	4 - 93
4.2.101	Reverse Run protection function (A044, b046).....	4 - 94
4.2.102	Torque LAD stop function (A044, b040 to b045).....	4 - 95
4.2.103	High-torque multi-motor operation (A044, F001, b040 to b044, H002 to H005, H020 to H024,H050 to H052)	4 - 95
4.2.104	Easy sequence function (A017, P100 to P131).....	4 - 96
4.2.105	Data read/write selection (b166)	4 - 96
4.3	Functions Available When the Feedback Option Board (SJ-FB) Is Mounted	4 - 97
4.3.1	Functions requiring the SJ-FB.....	4 - 97
4.3.2	V2 control pulse setting	4 - 97
4.3.3	Vector control with encoder feedback	4 - 98
4.3.4	Torque biasing function.....	4 - 99
4.3.5	Torque control function.....	4 - 99
4.3.6	Pulse train position control mode	4 - 100
4.3.7	Electronic gear function(Synchronous operation)	4 - 102
4.3.8	Motor gear ratio setting function.....	4 - 104
4.3.9	Position biasing function	4 - 104
4.3.10	Speed biasing function	4 - 104

4.3.11	Home search function	4 - 105
4.3.12	Absolute position control mode	4 - 107
4.3.13	Operation in absolute position control mode	4 - 108
4.3.14	Multistage position switching function (CP1/CP2/CP3)	4 - 109
4.3.15	Speed/position switching function (SPD)	4 - 109
4.3.16	Zero-return function	4 - 110
4.3.17	Forward/reverse drive stop function (FOT/ROT)	4 - 111
4.3.18	Position range specification function	4 - 111
4.3.19	Teaching function	4 - 111
4.3.20	Servo-on function	4 - 112
4.3.21	Pulse train frequency input	4 - 113
4.4	Communication Functions	4 - 114
4.4.1	Communication in ASCII mode	4 - 117
4.4.2	Communication in Modbus-RTU mode	4 - 130

Chapter 5 Error Codes

5.1	Error Codes and Troubleshooting	5 - 1
5.1.1	Error codes	5 - 1
5.1.2	Option boards error codes	5 - 5
5.1.3	Trip conditions monitoring	5 - 9
5.2	Warning Codes	5 - 10

Chapter 6 Maintenance and Inspection

6.1	Precautions for Maintenance and Inspection	6 - 1
6.1.1	Daily inspection	6 - 1
6.1.2	Cleaning	6 - 1
6.1.3	Periodic inspection	6 - 1
6.2	Daily and Periodic Inspections	6 - 2
6.3	Ground Resistance Test with a Megger	6 - 3
6.4	Withstand Voltage Test	6 - 3
6.5	Method of Checking the Inverter and Converter Circuits	6 - 4
6.6	DC-Bus Capacitor Life Curve	6 - 5
6.7	Output of Life Warning	6 - 5
6.8	Methods of Measuring the Input/Output Voltages, Current, and Power	6 - 6

Chapter 7 Specification

7.1	Specifications	7 - 1
7.2	External dimensions	7 - 4

Chapter 8 List of Data Settings

8.1	Precautions for Data Setting	8 - 1
8.2	Monitoring Mode	8 - 1
8.3	Function Mode	8 - 2
8.4	Extended Function Mode	8 - 3

Appendix

Appendix A - 1

Index

Index Index - 1

Chapter 1 Overview

This chapter describes the inspection of the purchased product, the product warranty, and the names of parts.

- 1.1 Inspection of the Purchased Product..... 1 - 1
- 1.2 Method of Inquiry and Product Warranty · 1 - 2
- 1.3 Exterior Views and Names of Parts..... 1 - 3

1.1 Inspection of the Purchased Product

1.1.1 Inspecting the product

After unpacking, inspect the product as described below.

If you find the product is abnormal or defective, contact your supplier or local Hitachi Distributor.

- (1) Check the product for damage (including falling of parts and dents in the inverter body) caused during transportation.
- (2) Check that the product package contains an inverter set, this Quick Reference Guide and a CD (including the SJ700D-3 Instruction Manual).
- (3) Check the specification label to confirm that the product is the one you have ordered.

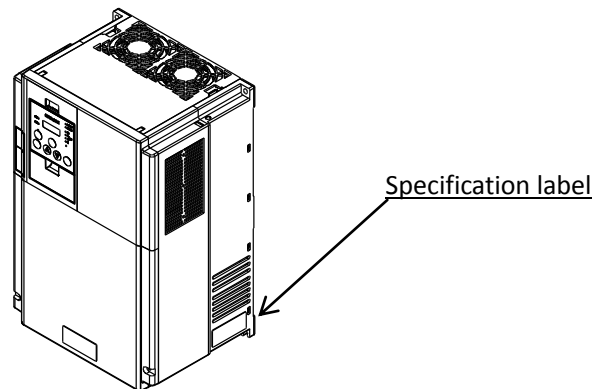

Figure 1 Location of the specifications label

HITACHI		INVERTER
Inverter model	→	Model: SJ700D-150HFF3
Input ratings	→	Input/Entree: 50Hz,60Hz _____ V 1 Ph _____ A
Output ratings	→	50Hz,60Hz 380-480V 3 Ph 35/41A
Serial number	→	Output/Sortie: 0 - 400Hz 380-480V 3 Ph 32/37A
		MEGNo. 44A T12345AA 001 _____ Date: 1404
		Hitachi Industrial Equipment Systems Co.,Ltd. MADE IN JAPAN NE18238-29

Figure 1-2 Contents of the specifications label

1.1.2 Instruction Manual (on CD)

This manual describes how to handle and maintain the Hitachi SJ700D-3 Series Inverter. Read these manuals carefully before using the inverter, and then keep it handy for those who operate, maintain, and inspect the inverter. When using the inverter together with optional products, also read the manuals for those products.

Note that these manuals and the manual for each optional product to be used should be delivered to the end user of the inverter.

1.2 Method of Inquiry and Product Warranty

1.2.1 Method of inquiry

For an inquiry about product damage or faults or a question about the product, notify your supplier of the following information:

- (1) Model of your inverter
- (2) Serial number (MFG No.)
- (3) Date of purchase
- (4) Content of inquiry
 - Location and condition of damage
 - Content of your question

1.2.2 Product warranty

The product will be warranted under the term described in the next section "1.2.3 Warranty Terms".

Even within the warranty period, repair of a product fault will not be covered by the warranty (but the repair will be at your own cost) if:

- (1) the fault has resulted from incorrect usage not conforming to the instructions given in this Instruction Manual or the repair or modification of the product carried out by an unqualified person,
- (2) the fault has resulted from a cause not attributable to the delivered product,
- (3) the fault has resulted from use beyond the limits of the product specifications, or
- (4) the fault has resulted from disaster or other unavoidable events.

The warranty will only apply to the delivered inverter and excludes all damage to other equipment and facilities induced by any fault of the inverter.

Repair at the user's charge :

Following the warranty period, any examination and repair of the product will be accepted at your charge. Even during the warranty period, examination and repairs of faults, subject to the above scope of the warranty disclaimer, will be available at charge. To request a repair at your charge, contact your supplier or local Hitachi Distributor.

1.2.3 Warranty Terms

The warranty period under normal installation and handling conditions shall be two (2) years from the date of manufacture ("DATE" on product nameplate), or one (1) year from the date of installation, whichever occurs first. The warranty shall cover the repair or replacement, at Hitachi's sole discretion, of ONLY the inverter that was installed.

- (1) Service in the following cases, even within the warranty period, shall be charged to the purchaser:
 - a. Malfunction or damage caused by mis-operation or modification or improper repair
 - b. Malfunction or damage caused by a drop after purchase and transportation
 - c. Malfunction or damage caused by fire, earthquake, flood, lightening, abnormal input voltage, contamination, or other natural disasters
- (2) When service is required for the product at your work site, all expenses associated with field repair shall be charged to the purchaser.
- (3) Always keep this manual handy; please do not lose it. Please contact your Hitachi distributor to purchase replacement or additional manuals.

1.3 Exterior Views and Names of Parts

The figure below shows an exterior view of the inverter.

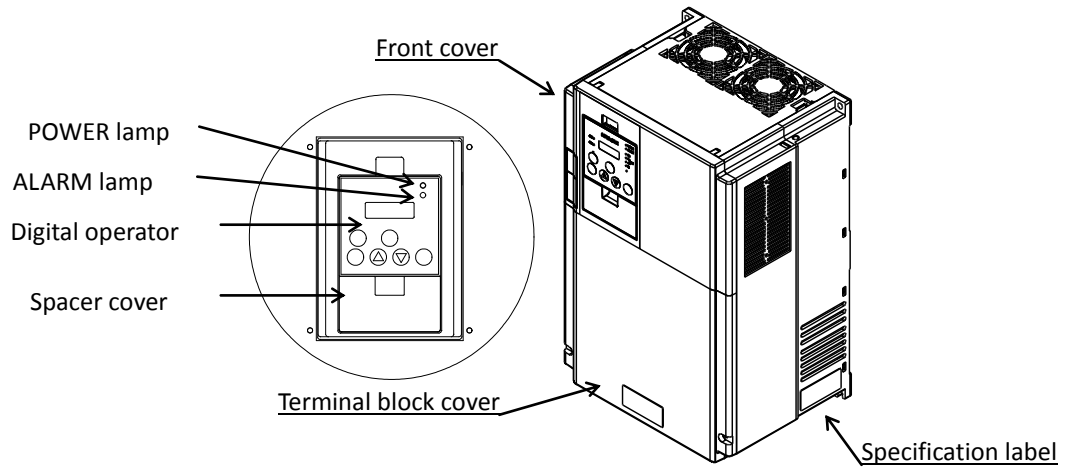

Exterior view of inverter

For the wiring of the main circuit and control circuit terminals, open the terminal block cover.
For mounting optional circuit boards, open the front cover.

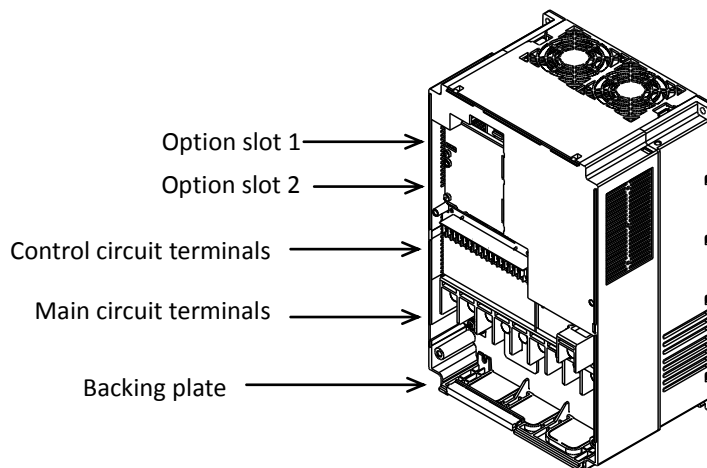

Exterior view of inverter with the removed front and terminal block covers

Chapter 2 Installation and Wiring

This chapter describes how to install the inverter and the wiring of main circuit and control signal terminals with typical examples of wiring.

2.1	Installation.....	2 - 1
2.2	Wiring.....	2 - 5

2.1 Installation

 **CAUTION**

- Install the inverter on a non-flammable surface, e.g., metal. Otherwise, you run the risk of fire.
- Do not place flammable materials near the installed inverter. Otherwise, you run the risk of fire.
- When carrying the inverter, do not hold its top cover. Otherwise, you run the risk of injury by dropping the inverter.
- Prevent foreign matter (e.g., cut pieces of wire, sputtering welding materials, iron chips, wire, and dust) from entering the inverter. Otherwise, you run the risk of fire.
- Install the inverter on a structure able to bear the weight specified in this Instruction Manual. Otherwise, you run the risk of injury due to the inverter falling.
- Install the inverter on a vertical wall that is free of vibrations. Otherwise, you run the risk of injury due to the inverter falling.
- Do not install and operate the inverter if it is damaged or its parts are missing. Otherwise, you run the risk of injury.
- Install the inverter in a well-ventilated indoor site not exposed to direct sunlight. Avoid places where the inverter is exposed to high temperature, high humidity, condensation, dust, explosive gases, corrosive gases, flammable gases, grinding fluid mist, or salt water. Otherwise, you run the risk of fire.
- The inverter is precision equipment. Do not allow it to fall or be subject to high impacts, step on it, or place a heavy load on it. Doing so may cause the inverter to fail.

2.1.1 Precautions for installation

(1) Transportation

The inverter uses plastic parts. When carrying the inverter, handle it carefully to prevent damage to the parts. Do not carry the inverter by holding the front or terminal block cover. Doing so may cause the inverter to fall. Do not install and operate the inverter if it is damaged or its parts are missing.

(2) Surface on which to install the inverter

The inverter will reach a high temperature (up to about 150°C) during operation. Install the inverter on a vertical wall surface made of nonflammable material (e.g., metal) to avoid the risk of fire.

Leave sufficient space around the inverter. In particular, keep sufficient distance between the inverter and other heat sources (e.g., braking resistors and reactors) if they are installed in the vicinity.

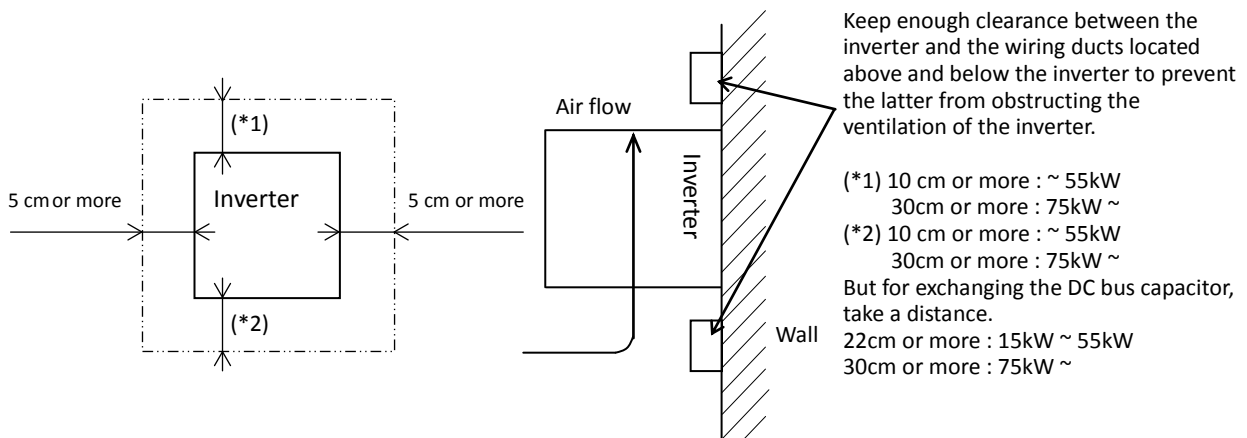

(3) Ambient temperature

Avoid installing the inverter in a place where the ambient temperature goes above or below the allowable range (-10°C to +40°C), as defined by the standard inverter specification.

Measure the temperature in a position about 5 cm distant from the bottom-center point of the inverter, and check that the measured temperature is within the allowable range.

Operating the inverter at a temperature outside this range will shorten the inverter life (especially the capacitor life).

(4) Humidity

Avoid installing the inverter in a place where the relative humidity goes above or below the allowable range (20% to 90% RH), as defined by the standard inverter specification.

Avoid a place where the inverter is subject to condensation.

Condensation inside the inverter will result in short circuits and malfunctioning of electronic parts. Also avoid places where the inverter is exposed to direct sunlight.

(5) Ambient air

Avoid installing the inverter in a place where the inverter is subject to dust, corrosive gases, combustible gases, flammable gases, grinding fluid mist, or salt water.

Foreign particles or dust entering the inverter will cause it to fail. If you use the inverter in a considerably dusty environment, install the inverter inside a totally enclosed panel.

(6) Installation method and position

Install the inverter vertically and securely with screws or bolts on a surface that is free from vibrations and that can bear the inverter weight. If the inverter is not installed vertically, its cooling performance may be degraded and tripping or inverter damage may result.

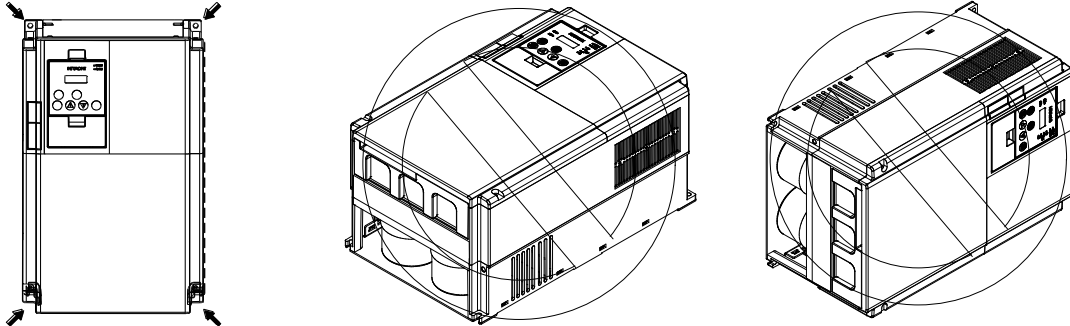

(7) When mounting multiple inverters in an enclosure with a ventilation fan, carefully design the layout of the ventilation fan, air intake port, and inverters. An inappropriate layout will reduce the inverter-cooling effect and raise the ambient temperature. Plan the layout so that the inverter ambient temperature will remain within the allowable range.

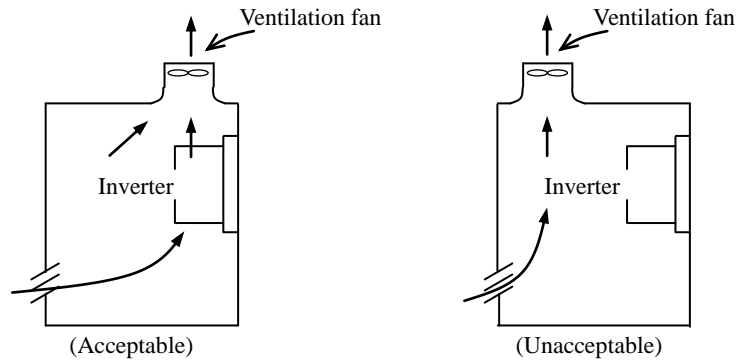

Position of ventilation fan

(8) Mounting in an enclosure

The internal fan releases the heat generated by the inverter from the upper part of the inverter. When it is necessary to install a device above the inverter, please ensure that the device is protected against this heat. When several inverters are mounted in the same cabinet the standard arrangement of the inverters is side-by-side with certain space as shown in the figure on the left below. If the inverters must be mounted one above the other in order to save the cabinet space or similar, the heat from the lower inverter may lead to temperature rise and breakdown of the higher inverter. Please ensure that the heat generated by the lower inverter does not affect the one above by installing a mechanical separation or similar (e.g. guide plate between the inverters as shown in the figure below right).

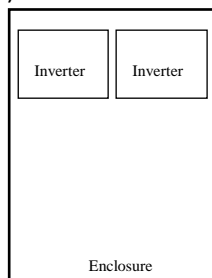

Horizontal mounting

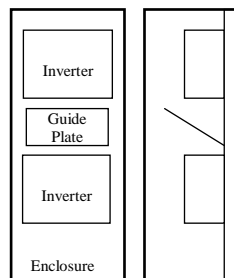

Vertical mounting

When mounting several inverters in the same cabinet, design the cabinet so that the temperature inside the cabinet does not exceed the allowable specific range for the inverter (by using increased ventilation and/or enlarging the size of cabinet etc.)

(9) Reduction of enclosure size

If you mount the inverter inside an enclosure such that the heat sink of the inverter is positioned outside the enclosure, the amount of heat produced inside the enclosure can be reduced and likewise the size of the enclosure. Mounting the inverter in an enclosure with the heat sink positioned outside requires an optional dedicated special metal fitting. To mount the inverter in an enclosure with the heat sink positioned outside, cut out the enclosure panel according to the specified cutting dimensions. The cooling section (including the heat sink) positioned outside the enclosure has a cooling fan. Therefore, do not place the enclosure in any environment where it is exposed to waterdrops, oil mist, or dust.

(10) Approximate loss by inverter capacity

Inverter capacity (kW)	0.4	0.75	1.5	2.2	3.7/4.0	5.5	7.5	11	15	18.5
Loss with 70% load (W)	64	76	102	127	179	242	312	435	575	698
Loss with 100% load (W)	70	88	125	160	235	325	425	600	800	975
Efficiency at rated output (%)	85.1	89.5	92.3	93.2	94.0	94.4	94.6	94.8	94.9	95.0

Inverter capacity (kW)	22	30	37	45	55	75	90	110	132/150
Loss with 70% load (W)	820	1100	1345	1625	1975	2675	3375	3900	4670
Loss with 100% load (W)	1150	1550	1900	2300	2800	3800	4800	5550	6650
Efficiency at rated output (%)	95.0	95.0	95.1	95.1	95.1	95.2	95.2	95.2	95.2

2.1.2 Backing plate

(1) For models with 30 kW or less capacity

On the backing plate, cut the joints around each section to be cut off with cutting pliers or a cutter, remove them, and then perform the wiring.

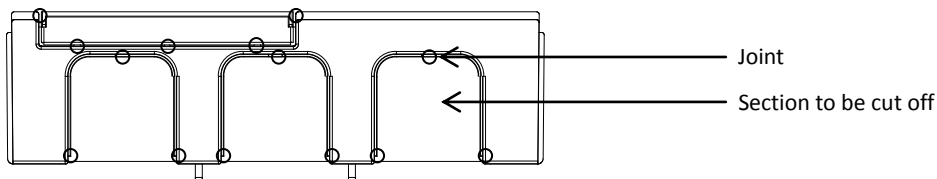

(2) For the models with 37 kW to 75kW

1) For wiring without using conduits

Cut an X in each rubber bushing of the backing plate with cutting pliers or a cutter, and then perform the wiring.

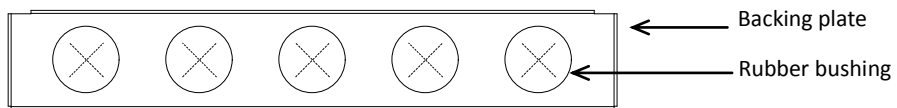

2) For wiring using conduits

Remove the rubber bushings from the holes to be used for wiring with conduits, and then fit conduits into the holes.

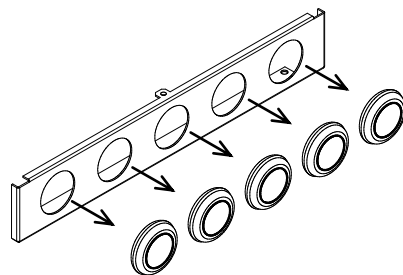

Note: Do not remove the rubber bushing from holes that are not used for wiring with a conduit.

If a cable is connected through the plate hole without a rubber bushing and conduit, the cable insulation may be damaged by the edge of the hole, resulting in a short circuit or ground fault.

2.2 Wiring

**WARNING**

- Be sure to ground the inverter. Otherwise, you run the risk of electric shock or fire.
- Commit wiring work to a qualified electrician. Otherwise, you run the risk of electric shock or fire.
- Before wiring, make sure that the power supply is off. Otherwise, you run the risk of electric shock or fire.
- Perform wiring only after installing the inverter. Otherwise, you run the risk of electric shock or injury.
- Do not remove rubber bushings from the wiring section. Otherwise, the edges of the wiring cover may damage the wire, resulting in a short circuit or ground fault.

**CAUTION**

- Make sure that the voltage of AC power supply matches the rated voltage of your inverter. Otherwise, you run the risk of injury or fire.
- Do not input single-phase power into the inverter. Otherwise, you run the risk of fire.
- Do not connect AC power supply to any of the output terminals (U, V, and W). Otherwise, you run the risk of injury or fire.
- Do not connect a resistor directly to any of the DC terminals (PD, P, and N). Otherwise, you run the risk of fire.
- Connect an earth-leakage breaker to the power input circuit. Otherwise, you run the risk of fire.
- Use only the power cables, earth-leakage breaker, and magnetic contactors that have the specified capacity (ratings). Otherwise, you run the risk of fire.
- Do not use the magnetic contactor installed on the primary and secondary sides of the inverter to stop its operation.
- Tighten each screw to the specified torque. No screws must be left loose. Otherwise, you run the risk of fire.
- Before operating, slide switch SW1 in the inverter, be sure to turn off the power supply. Otherwise, you run the risk of electric shock and injury.
- Since the inverter supports two modes of cooling-fan operation, the inverter power is not always off, even when the cooling fan is stopped. Therefore, be sure to confirm that the power supply is off before wiring. Otherwise, you run the risk of electric shock and injury.

2.2.1 Terminal connection diagram and explanation of terminals and switch settings

3-phase power supply

200 V class: 200 to 240 V +10%, -15%
(50/60 Hz ±5%)

400 V class: 380 to 480 V +10%, -15%
(50/60 Hz ±5%)

When connecting separate power supplies to main and control circuits, remove J51 connector cables beforehand.

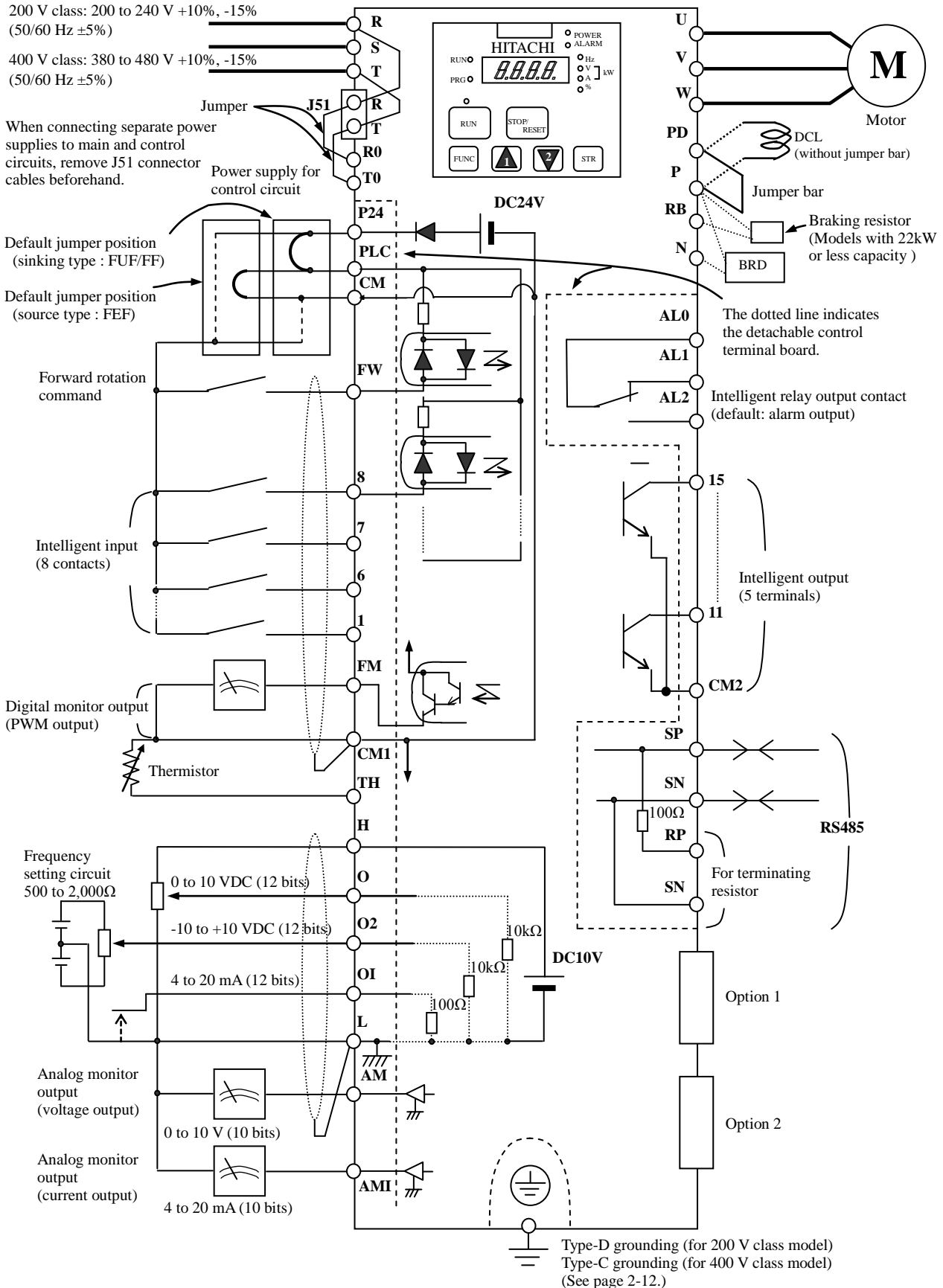

(1) Explanation of main circuit terminals

Symbol	Terminal name	Description
R, S, T (L1, L2, L3)	Main power input	Connect to the AC power supply. Leave these terminals unconnected when using a regenerative converter (HS900 series).
U, V, W (T1, T2, T3)	Inverter output	Connect a 3-phase motor.
PD, P (+1, +)	DC reactor connection	Remove the jumper from terminals PD and P, and connect the optional power factor reactor (DCL).
P, RB (+, RB)	External braking resistor connection	Connect the optional external braking resistor. (The RB terminal is provided on models with 30 kW or less capacity.)
P, N (+, -)	Regenerative braking unit connection	Connect the optional regenerative braking unit (BRD).
G ⊕	Inverter ground	Connect to ground for grounding the inverter chassis by type-D grounding (for 200 V class models) or type-C grounding (for 400 V class models).

(2) Explanation of control circuit terminals

		Symbol	Terminal name	Description	Electric property	
Analog	Power supply	L	Analog power supply (common)	This common terminal supplies power to frequency command terminals (O, O2, and OI) and analog output terminals (AM and AMI). Do not ground this terminal.		
		H	Frequency setting power supply	This terminal supplies 10 VDC power to the O, O2, OI terminals.		Allowable load current: 20 mA or less
	Frequency setting input	O	Frequency command (voltage)	Input a voltage (0 to 10 VDC) as a frequency command. 10 V specifies the maximum frequency. To specify the maximum frequency with a voltage of 10 V or less, set the voltage using function "A014".	Input impedance: 10kΩ Allowable input voltages: -0.3 to +12 VDC	
		O2	Auxiliary frequency command (voltage)	Input a voltage (0 to ±10 VDC) as a signal to be added to the frequency command input from the O or OI terminal. You can input an independent frequency command from this terminal (O2 terminal) alone by changing the setting.	Input impedance: 10kΩ Allowable input voltages: 0 to ±12 VDC	
		OI	Frequency command (current)	Input a current (4 to 20 mA DC) as a frequency command. 20 mA specifies the maximum frequency. The OI signal is valid only when the AT signal is on. Assign the AT function to an intelligent input terminal.	Input impedance: 10kΩ Maximum allowable current: 24 mA	
	Monitor output	AM	Analog monitor (voltage)	This terminal outputs one of the selected "0 to 10 VDC voltage output" monitoring items. The monitoring items available for selection include output frequency, output current, output torque (signed or unsigned), output voltage, input power, electronic thermal overload, LAD frequency, motor temperature, heat sink temperature, and general output.	Maximum allowable current: 2 mA Output voltage accuracy ±20% (Ta=25±10 degrees C)	
		AMI	Analog monitor (current)	This terminal outputs one of the selected "4 to 20 mA DC current output" monitoring items. The monitoring items available for selection include output frequency, output current, output torque (unsigned), output voltage, input power, electronic thermal overload, LAD frequency, motor temperature, heat sink temperature, and general output.	Allowable load impedance: 250Ω or less Output current accuracy ±20% (Ta=25±10 degrees C)	
	Digital (contact)	Monitor output	FM	Digital monitor (voltage)	This terminal outputs one of the selected "0 to 10 VDC voltage output (PWM output mode)" monitoring items. The monitoring items available for selection include output frequency, output current, output torque (unsigned), output voltage, input power, electronic thermal overload, LAD frequency, motor temperature, heat sink temperature, general output, digital output frequency, and digital current monitor. For the items "digital output frequency" and "digital current monitor," this terminal outputs a digital pulse signal at 0/10 VDC with a duty ratio of 50%.	Maximum allowable current: 1.2 mA Maximum frequency: 3.6 kHz
		Power supply	P24	Interface power supply	This terminal supplies 24 VDC power for contact input signals. If the source logic is selected, this terminal is used as a common contact input terminal.	Maximum allowable output current: 100 mA
			CM1	Interface power supply (common)	This common terminal supplies power to the interface power supply (P24), thermistor input (TH), and digital monitor (FM) terminals. If the sink logic is selected, this terminal is used as a common contact input terminal. Do not ground this terminal.	
Contact input		Operation command	FW	Forward rotation command	Turn on this FW signal to start the forward rotation of the motor; turn it off to stop forward rotation after deceleration.	[Conditions for turning contact input on] Voltage across input and PLC: 18 VDC or more
		Function selection and logic switching	1 2 3 4 5 6 7 8	Intelligent input	Select eight of a total 56 functions, and assign these eight functions to terminals 1 to 8. Note: If the emergency stop function is used, terminals 1 and 3 are used exclusively for the function. For details, see Item (3), "Explanation of switch "(on page 2-10).	Input impedance between input and PLC: 4.7kΩ Maximum allowable voltage across input and PLC: 27 VDC Load current with 27 VDC power: about 5.6 mA

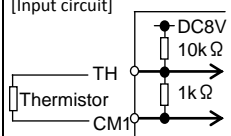
			Symbol	Terminal name	Description	Electric property
Digital (contact)	Contact input	Function selection and logic switching	PLC	Intelligent input (common)	To switch the control logic between sink logic and source logic, change the jumper connection of this (PLC) terminal to another terminal on the control circuit terminal block. Jumper terminals P24 and PLC for the sink logic; jumper terminals CM1 and PLC for the sink logic. To use an external power supply to drive the contact inputs, remove the jumper, and connect the PLC terminal to the external interface circuit.	
	Open collector output	Status and factor	11 12 13 14 15	Intelligent output	Select five of a total 51 functions, and assign these five functions to terminals 11 to 15. If you have selected an alarm code using the function "C062", terminals 11 to 13 or 11 to 14 are used exclusively for the output of cause code for alarm (e.g., inverter trip). The control logic between each of these terminals and the CM2 terminal always follows the sink or source logic.	Voltage drop between each terminal and CM2 when output signal is on: 4 V or less Maximum allowable voltage: 27 VDC
			CM2	Intelligent output (common)	This terminal serves as the common terminal for intelligent output terminals [11] to [15].	Maximum allowable current: 50 mA
Relay contact output	Status and alarm	AL0 AL1 AL2	Intelligent relay output	Select functions from the 43 available, and assign the selected functions to these terminals, which serve as C contact output terminals. In the initial setting, these terminals output an alarm indicating that the inverter protection function has operated to stop inverter output.	(Maximum contact capacity) AL1-AL0: 250 VAC, 2 A (resistance) or 0.2 A (inductive load) AL2-AL0: 250 VAC, 1 A (resistance) or 0.2 A (inductive load) (Minimum contact capacity) 100 VAC, 10 mA 5 VDC, 100 mA	
Analog	Analog input	Sensor	TH	External thermistor input	Connect to an external thermistor to make the inverter trip if an abnormal temperature is detected. The CM1 terminal serves as the common terminal for this terminal. [Recommended thermistor properties] Allowable rated power: 100 mW or more Impedance at temperature error: 3kΩ The impedance to detect temperature errors can be adjusted within the range 0Ω to 9,999Ω.	Allowable range of input voltages 0 to 8 VDC [Input circuit] 

(3) Explanation of switch

The internal slide switch (SW1) is used to enable or disable the emergency stop function (the function is disabled by factory setting).

* For the location of the slide switch, see page 2-10.

About the emergency stop function (disabled by the factory setting)

- The emergency stop function shuts off the inverter output (i.e. stops the switching operation of the main circuit elements) in response to a command from a hardware circuit via an intelligent input terminal without the operation by internal CPU software.

Note: The emergency stop function does not electrically shut off the inverter but merely stops the switching operation of the main circuit elements. Therefore, do not touch any terminals of the inverter or any power lines, e.g., motor cables. Otherwise, electric shock, injury, or ground fault may result.

- When the emergency stop function is enabled, intelligent input terminals 1 and 3 are used exclusively for this function, and no other functions can be assigned to these terminals. Even if other functions have been assigned to these terminals, these are automatically disabled and these terminals are used exclusively for the emergency stop function.

Terminal [1] function:

This terminal always serves as the a (NO) contact for the reset (RS) signal.

This signal resets the inverter and releases the inverter from the trip due to emergency stop (E37.*).

Terminal [3] function:

This terminal always serves as the b (NC) contact for the emergency stop (EMR) signal.

This signal shuts off the inverter output without the operation by internal CPU software.

This signal makes the inverter trip due to emergency stop (E37.*).

- Note: If intelligent input terminal 3 is left unconnected, the cable connected to the terminal is disconnected, or the signal logic is improper, the inverter trips due to emergency stop (E37.*). If this occurs, check and correct the wiring and signal logic, and then input the reset (RS) signal.

Only the reset (RS) signal input from intelligent input terminal [1] can release the inverter from tripping due to emergency stop (E37.*). (The inverter cannot be released from the E37.* status by any operation from the digital operator.)

- To enable the emergency stop function, set the slide lever of slide switch SW1 to ON. (With the factory setting, slide switch SW1 is set to OFF to disable the function.)

Note: Before operating slide switch SW1, make sure that the input power supply is off.

Setting of slide switch SW1 setting and function selection for intelligent input terminals [1] and [3]								
Setting of slide switch SW1	Intelligent input terminal [1]				Intelligent input terminal [3]			
	Terminal [1] function [C001]		a/b (NO/NC) selection [C011] (*1)		Terminal [3] function [C003]		a/b (NO/NC) selection [C013] (*1) (*2)	
SW1 is OFF. Emergency stop disabled (factory setting)	Selectable arbitrarily (*4)				Selectable arbitrarily (*4)			
	Factory setting	18 (RS)	Factory setting	00 (NO)	Factory setting	06 (JG)	Factory setting	00 (NO)
SW1 is ON. Emergency stop enabled (*5)	Automatic assignment of functions to intelligent input terminals [1] and [3] and the terminal to which function "18 (RS)" has been assigned (*3)							
	Fixed function (cannot be changed)	18 (RS)	Fixed function (cannot be changed)	00 (NO)	Fixed function (cannot be changed)	64 (EMR)	Fixed function (cannot be changed)	01 (NC)
SW1 is ON (after setting to OFF once). Emergency stop disabled (*3) (*5)	Selectable arbitrarily (*4)				Selectable arbitrarily (*4)			
	Setting made when SW1 is set ON retained	18 (RS)	Setting made when SW1 is set ON retained	00 (NO)	Released from emergency stop function	no (No function assigned)	Setting made when SW1 is set ON retained	01 (NC)

*1 When function "18 (RS)" is assigned to the input terminal, "a/b (NO/NC)" selection is always "00 (NO)".

*2 When terminal setting "C003" is "64 (EMR)", terminal setting "C013" is always "01 (NC)".

*3 If function "18 (RS)" has been assigned to an intelligent input terminal other than intelligent input terminals [1] and [3] before slide switch SW1 is set to ON, the input terminal setting for said terminal is automatically changed to "no (no function assigned)" when slide switch SW1 is set to ON to prevent any duplication of terminal functions. Even if slide switch SW1 is subsequently returned to OFF, the original function setting for said terminal will not be restored. If necessary, the original function will have to be re-assigned to said terminal.

Example: If slide switch SW1 is set to ON when function "18 (RS)" has been assigned to input terminal 2 (by terminal setting "C002"), terminal setting "C002" is changed to "no (no function assigned)," and function "18 (RS)" is assigned to input terminal 1 (by terminal setting "C001").

Even if slide switch SW1 is subsequently returned to OFF, terminal [2] function "C002" and terminal [1] function "C001" will remain as "no (no function assigned)" and "18 (RS)," respectively.

- *4 Function "64 (EMR)" cannot be assigned to input terminal 3 by an operation from the digital operator. The function is automatically assigned to the terminal when slide switch SW1 is set to ON.
- *5 After slide switch SW1 has been set to ON once, function assignments to intelligent input terminals [1] and [3] are not returned to their original assignments. If necessary, re-assign original functions to the intelligent input terminals.

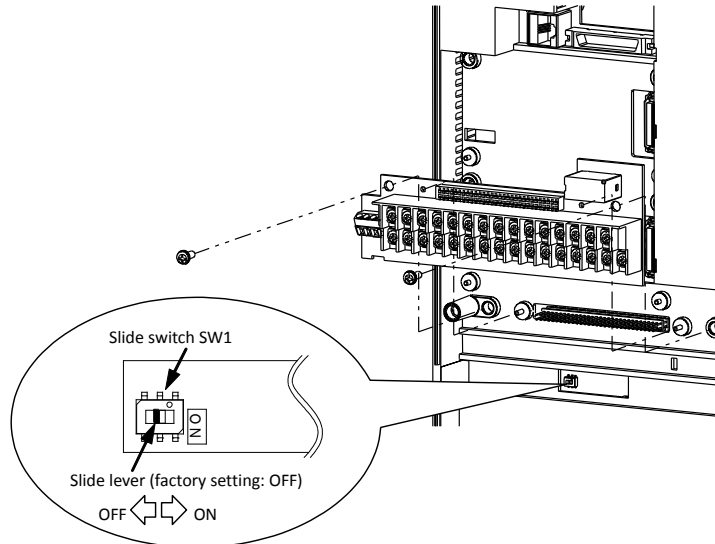

Note: If the data of an optional operator (WOP, SRW or SRW-EX) is copied:
 If operator data is copied to your SJ700 series inverter whose slide switch SW1 is ON from another SJ700 series inverter whose slide switch SW1 is OFF or an SJ300 series inverter, the digital operator on your SJ700 series inverter may display [R-ERROR COPY ROM] for a moment. This event may occur because the data on intelligent input terminals [1] and [3] cannot be copied since, on your inverter, exclusive functions have already been assigned to intelligent input terminals [1] and [3] due to the slide switch SW1 setting to ON. Note that other data is copied. If this event occurs, check the settings on both copy-source and copy-destination inverters.

Note: Slide Switch 12

Some models have slide switch in the position as shown below. Default setting of this switch is at "ON" position.

Please don't change the setting. If it is changed, inverter may trip and disabled to run.

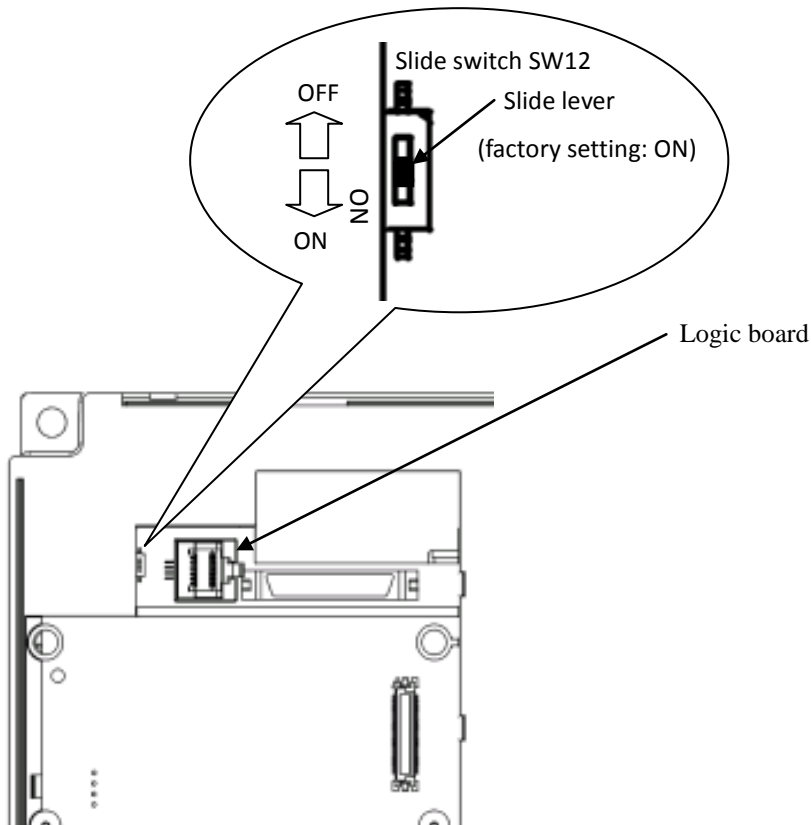

2.2.2 Wiring of the main circuit

(1) Wiring instructions

Before wiring, be sure to confirm that the Charge lamp on the inverter is turned off. When the inverter power has been turned on once, a dangerous high voltage remains in the internal capacitors for some time after power-off, regardless of whether the inverter has been operated. When rewiring after power-off, always wait 10 minutes or more after power-off, and check with a multimeter that the residual voltage across terminals P and N is zero to ensure safety during rewiring work.

(note) As for the 5.5kW and 7.5kW inverters, the washer on the main terminal screw (R, S, T, PD, P, N, U, V, W, RB) has two cutouts. Since those cutouts are to avoid the cable fixing portion of crimp terminal goes under the washer, it should be fixed in direction with those two cutouts in line with cable as described below. Otherwise, you run the risk of loose connection and fire.

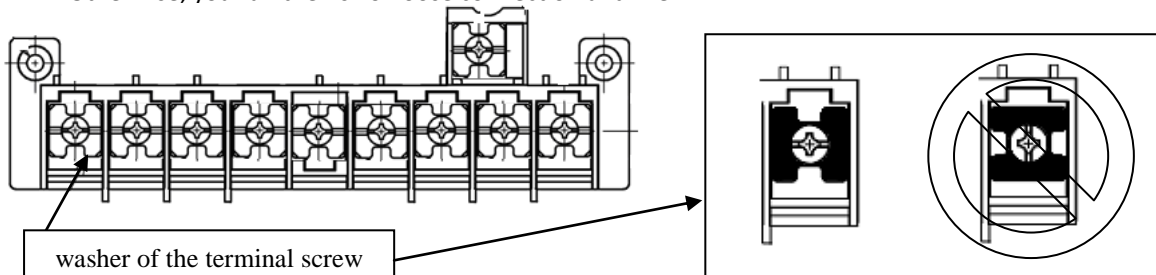

1) Main power input terminals (R, S, and T)

- Install an earth-leakage breaker for circuit (wiring) protection between the power supply and main power input terminals (R, S, and T).
- Use an earth-leakage breaker with a high rating of a high-frequency sensitive current to prevent the breaker from malfunctioning under the influence of high frequency.
- When the protective function of the inverter operates, a fault or accident may have occurred in your system. Therefore, you are recommended to connect a magnetic contactor that interrupts the power supply to the inverter.
- Do not use the magnetic contactor connected to the power input terminal (primary side) or power output terminal (secondary side) of the inverter to start or stop the inverter. To start and stop inverter operation by external signals, use only the operation commands (FW and RV signals) that are input via control circuit terminals.
- This inverter does not support a single-phase input but supports only a three-phase input. If you need to use a single-phase power input, contact your supplier or local Hitachi Distributor.
- Do not operate the inverter when an input phase is lost (input phase loss), otherwise the inverter may be damaged. Since the factory setting of the inverter disables the phase loss input protection, the inverter will go into the following status if a phase of power supply input is interrupted and not supplied to the inverter:
 - R or T phase interrupted: The inverter does not power up.
 - S phase interrupted: The inverter goes into single-phase operation, and may trip because of insufficient voltage or overcurrent, or be damaged.

Internal capacitors remain charged, even when the power input is under a phase loss condition. Therefore, touching an internal part may result in electric shock and injury.

When rewiring the main circuit, follow the instructions given in Item (1), "Wiring instructions."

- Carefully note that the internal converter module of the inverter may be damaged if:

- The imbalance of power voltage is 3% or more,
- The power supply capacity is at least 10 times as high as the inverter capacity and 500 kVA or more, or
- The power voltage changes rapidly.

Example: The above conditions may occur when multiple inverters are connected to each other by a short bus line or your system includes a phase-advanced capacitor that is turned on and off during operation.

- Do not turn the inverter power on and off more often than once every 3 minutes. Otherwise, the inverter may be damaged.

2) Inverter output terminals (U, V, and W)

- Use a cable thicker than the specified applicable cable for the wiring of output terminals to prevent the output voltage between the inverter and motor dropping. Especially at low frequency output, a voltage drop due to cable will cause the motor torque to decrease.
- Do not connect a phase-advanced capacitor or surge absorber on the output side of the inverter. If connected, the inverter may trip or the phase-advanced capacitor or surge absorber may be damaged.
- If the cable length between the inverter and motor exceeds 20 m (especially in the case of 400 V class models), the stray capacitance and inductance of the cable may cause a surge voltage at motor terminals, resulting in a motor burnout. A special filter to suppress the surge voltage is available. If you need this filter, contact your supplier or local Hitachi Distributor.
- When connecting multiple motors to the inverter, connect a thermal relay to the inverter output circuit for each motor.
- The RC rating of the thermal relay must be 1.1 times as high as the rated current of the motor. The thermal relay may go off too early, depending on the cable length. If this occurs, connect an AC reactor to the output of the inverter.

3) DC reactor connection terminals (PD and P)

- Use these terminals to connect the optional DC power factor reactor (DCL). As the factory setting, terminals P and PD are connected by a jumper. Remove this to connect the DCL.
- The cable length between the inverter and DCL must be 5 m or less.

Remove the jumper only when connecting the DCL. If the jumper is removed and the DCL is not connected, power is not supplied to the main circuit of the inverter, and the inverter cannot operate.

4) External braking resistor connection terminals (P and RB) and regenerative braking unit connection terminals (P and N)

- Inverter models with 22 kW or less capacity have a built-in regenerative braking (BRD) circuit. If you need increased braking performance, connect an optional external braking resistor to terminals P and RB. Do not connect an external braking resistor with resistance less than the specified value. Such a resistor may cause damage to the regenerative braking (BRD) circuit.
- Inverter models with capacity of 30 kW or more do not have a built-in regenerative braking (BRD) circuit. Increasing the braking performance of these models requires an optional regenerative braking unit and an external braking resistor. Connect the P and N terminals of the optional regenerative braking unit to the P and N terminals of the inverters.
- The cable length between the inverter and optional regenerative braking unit must be 5 m or less, and the two cables must be twisted for wiring.
- Do not use these terminals for connecting any devices other than the optional external braking resistor and regenerative braking unit.

5) Inverter ground terminal (G \oplus)

- Be sure to ground the inverter and motor to prevent electric shock.
- According to the Electric Apparatus Engineering Regulations, connect 200 V class models to grounding electrodes constructed in compliance with type-D grounding (conventional type-III grounding with ground resistance of 100 Ω or less) or the 400 V class models to grounding electrodes constructed in compliance with type-C grounding (conventional special type-III grounding with ground resistance of 10 Ω or less).
- Use a grounding cable thicker than the specified applicable cable, and make the ground wiring as short as possible.
- When grounding multiple inverters, avoid a multi-drop connection of the grounding route and formation of a ground loop, otherwise the inverter may malfunction.

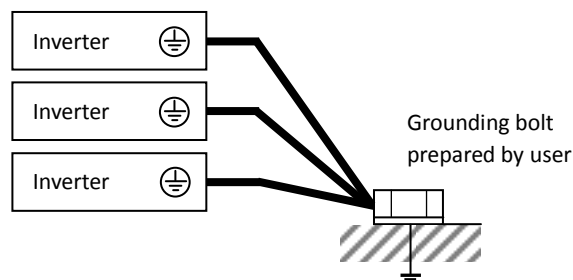
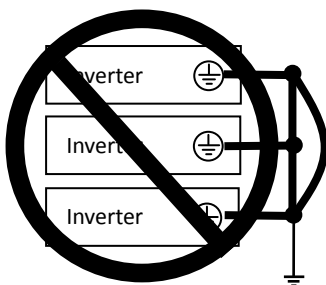

(2) Layout of main circuit terminals

The figures below show the terminal layout on the main circuit terminal block of the inverter.

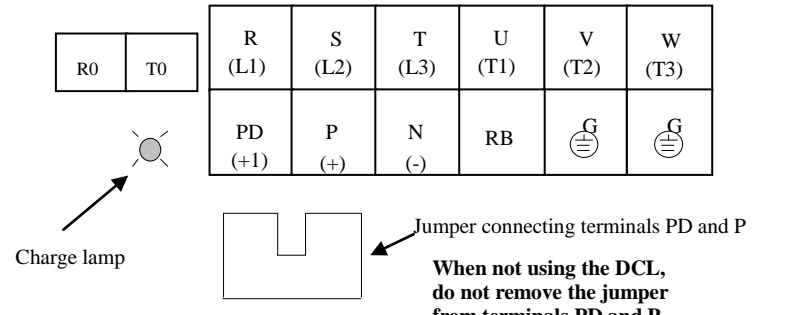
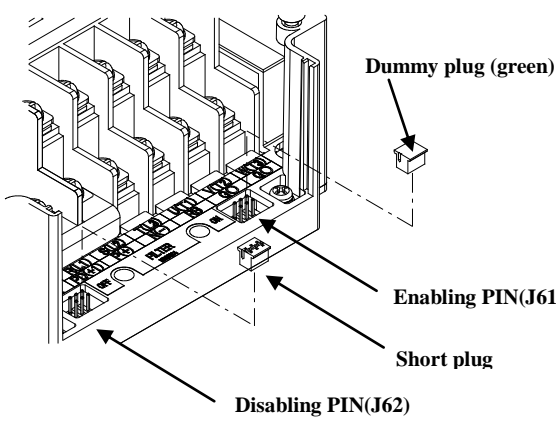
Terminal layout	Inverter model									
<div style="text-align: center;">  </div> <p>[Method of enabling/disabling the EMC filter function]</p> <div style="display: flex; justify-content: space-between;"> <div style="width: 45%;">  </div> <div style="width: 50%;"> <p>If you need to activate the EMC filter, you need to set the dummy plug and the short plug in reference to below list appropriately.</p> <p>Note: Before setting the plugs, make sure that the power supply is off. Otherwise, you run the risk of electric shock. You need to set the plugs before power supply to the inverter.</p> </div> </div> <table border="1" style="width: 100%; border-collapse: collapse; margin-top: 10px;"> <thead> <tr> <th style="width: 30%;"></th> <th style="width: 35%; text-align: center;">Enabling PIN(J61)</th> <th style="width: 35%; text-align: center;">Disabling PIN(J62)</th> </tr> </thead> <tbody> <tr> <td style="text-align: center;">EMC filter disables (factory setting)</td> <td style="text-align: center;">Dummy plug (green)</td> <td style="text-align: center;">Short plug</td> </tr> <tr> <td style="text-align: center;">EMC filter enables</td> <td style="text-align: center;">Short plug</td> <td style="text-align: center;">Dummy plug (green)</td> </tr> </tbody> </table>		Enabling PIN(J61)	Disabling PIN(J62)	EMC filter disables (factory setting)	Dummy plug (green)	Short plug	EMC filter enables	Short plug	Dummy plug (green)	<p>SJ700D-004-037L FF3/FEF3/FUF3</p> <p>SJ700D-007-037H FF3/FEF3/FUF3</p> <p>R0 and T0: M4 Ground terminal: M4 Other terminals: M4</p>
	Enabling PIN(J61)	Disabling PIN(J62)								
EMC filter disables (factory setting)	Dummy plug (green)	Short plug								
EMC filter enables	Short plug	Dummy plug (green)								

Terminal layout	Inverter model
<p>Charge lamp</p> <p>R (L1) S (L2) T (L3) PD (+1) P (+) N (-) U (T1) V (T2) W (T3)</p> <p>RB R0 T0</p> <p>G</p> <p>Jumper connecting terminals PD and P</p> <p>Ground terminal with jumper (shaded in the figure) to enable/disable the EMC filter function.</p> <p>When not using the DCL, do not remove the jumper from terminals PD and P.</p> <p>[Method of enabling/disabling the EMC filter function]</p> <p>Enabling the EMC filter</p> <p>Disabling the EMC filter (factory setting)</p>	<p>SJ700D-055, 075L FF3/FEF3/FUF3</p> <p>SJ700D-055, 075H FF3/FEF3/FUF3</p> <p>R0 and T0: M4 Ground terminal: M5 Other terminals: M5</p> <p>SJ700D-110L FF3/FEF3/FUF3</p> <p>SJ700D-110H FF3/FEF3/FUF3</p> <p>R0 and T0: M4 Ground terminal: M5 Other terminals: M6</p>
<p>Charge lamp</p> <p>R (L1) S (L2) T (L3) PD (+1) P (+) N (-) U (T1) V (T2) W (T3)</p> <p>R0 T0 RB</p> <p>G</p> <p>Jumper connecting terminals PD and P</p> <p>Ground terminal with jumper (shaded in the figure) to enable/disable the EMC filter function</p> <p>When not using the DCL, do not remove the jumper from terminals PD and P.</p> <p>[Method of enabling/disabling the EMC filter function]</p> <p>Enabling the EMC filter</p> <p>Disabling the EMC filter (factory setting)</p>	<p>SJ700D-150 to 185L FF3/FEF3/FUF3</p> <p>SJ700D-150 to 220H FF3/FEF3/FUF3</p> <p>R0 and T0: M4 Ground terminal: M6 Other terminals: M6</p> <p>SJ700D-220L FF3/FEF3/FUF3</p> <p>R0 and T0: M4 Ground terminal: M6 Other terminals: M8</p>

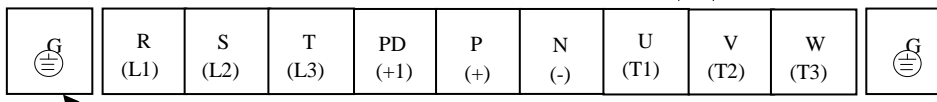
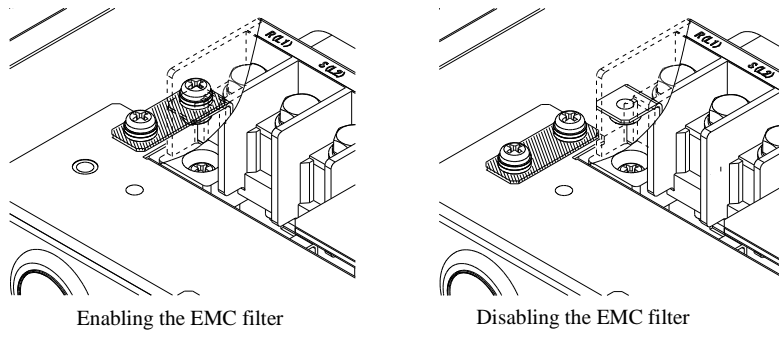
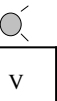
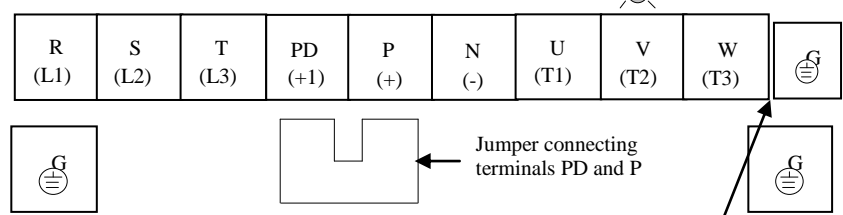
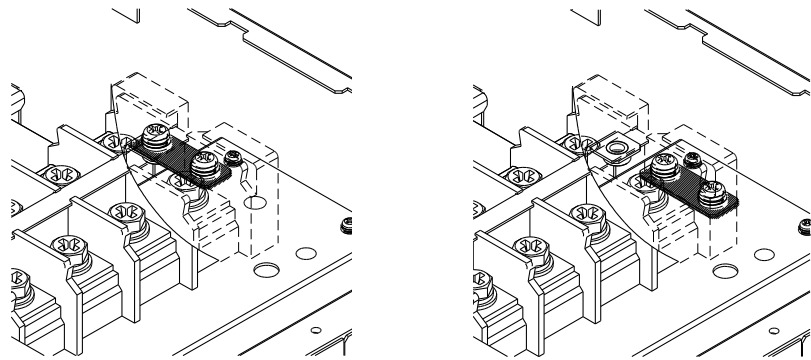
Terminal layout	Inverter model
<p style="text-align: center;">Charge lamp </p> <p style="text-align: center;">R0 T0</p>  <p>Ground terminal with jumper (shaded in the figure) to enable/disable the EMC filter function</p> <p>Jumper connecting terminals PD and P</p> <p>When not using the DCL, do not remove the jumper from terminals PD and P.</p> <p>[Method of enabling/disabling the EMC filter function]</p>  <p>Enabling the EMC filter</p> <p>Disabling the EMC filter (factory setting)</p>	<p>SJ700D-300L FF3/FEF3/FUF3</p> <p>R0 and T0: M4 Ground terminal: M6 Other terminals: M8</p> <hr/> <p>SJ700D-300H FF3/FEF3/FUF3</p> <p>R0 and T0: M4 Ground terminal: M6 Other terminals: M6</p> <hr/> <p>SJ700D-370L FF3/FEF3/FUF3</p> <p>SJ700D-370H FF3/FEF3/FUF3</p> <p>R0 and T0: M4 Ground terminal: M8 Other terminals: M8</p>
<p style="text-align: center;">Charge lamp </p> <p style="text-align: center;">R0 T0</p>  <p>Jumper connecting terminals PD and P</p> <p>Ground terminal with jumper (shaded in the figure) to enable/disable the EMC filter function</p> <p>When not using the DCL, do not remove the jumper from terminals PD and P.</p> <p>[Method of enabling/disabling the EMC filter function]</p>  <p>Enabling the EMC filter</p> <p>Disabling the EMC filter (factory setting)</p>	<p>SJ700D-450L FF3/FEF3/FUF3</p> <p>SJ700D-450H FF3/FEF3/FUF3</p> <p>SJ700D-550H FF3/FEF3/FUF3</p> <p>R0 and T0: M4 Ground terminal: M8 Other terminals: M8</p>

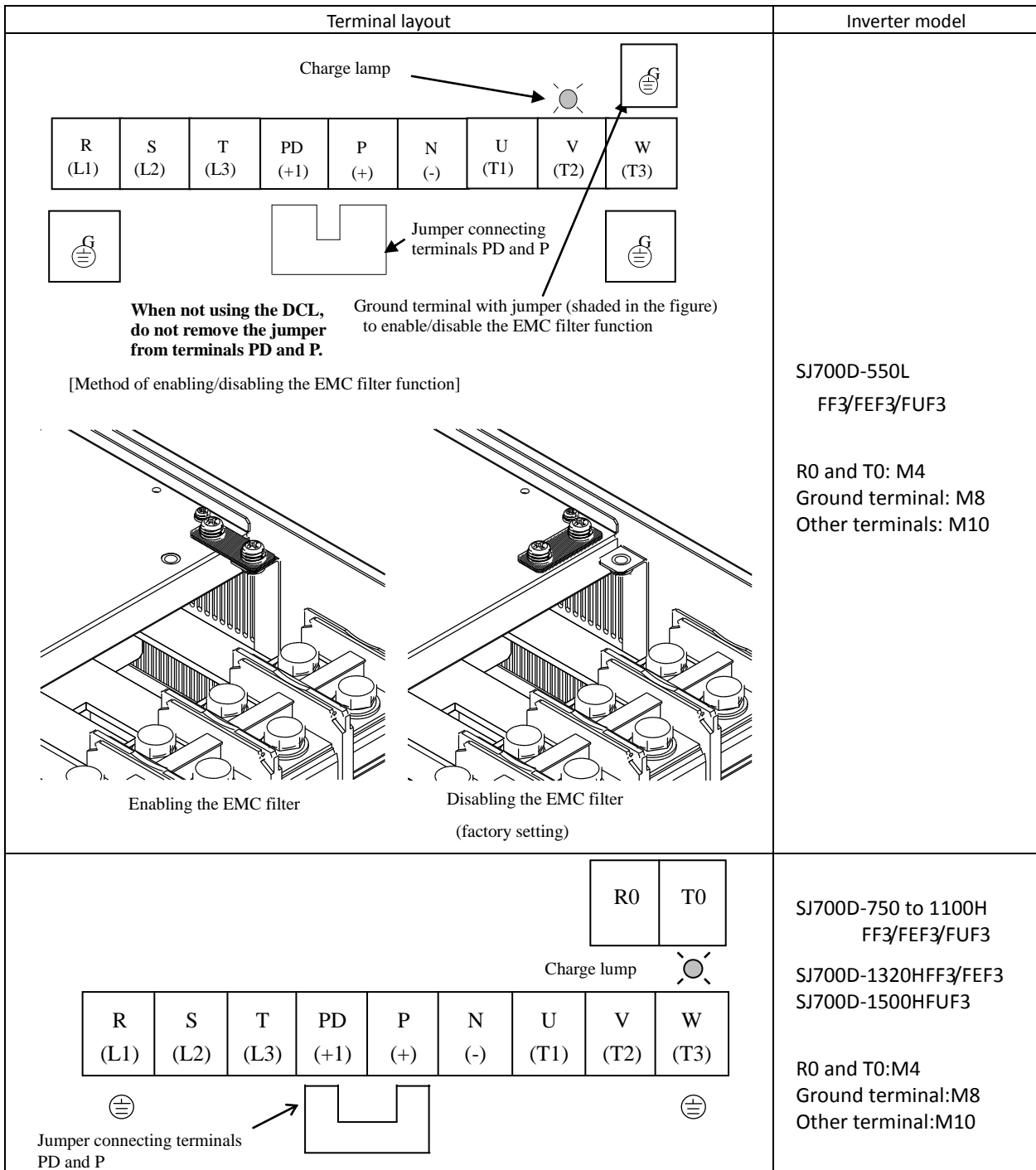

Reference: Leakage current by inverter with model EMC filter enabled or disabled (reference data). The table below lists the reference currents that may leak from the inverter when the internal EMC filter is enabled or disabled. (Leakage current is in proportion to the voltage and frequency of input power.) Note that the values listed in the table below indicate the reference currents leaking from the inverter alone. The values exclude current leakage from external devices and equipment (e.g., power cables). The drive in the range from 75kW to 150kW doesn't have the switch to activate and deactivate the internal EMC filter. They comply EMC directive C3 level in standard condition.

	200 V class model (input power: 200 VAC, 50 Hz)				400 V class model (input power: 400 VAC, 50 Hz)				
	0.4kW to 3.7kW	5.5kW to 11kW	15kW to 37kW	45kW to 55kW	0.75kW to 3.7kW	5.5kW to 11kW	15kW to 37kW	45kW to 55kW	75kW to 150kW
Internal EMC filter enabled	Ca. 2.5mA	Ca. 48mA	Ca. 23mA	Ca. 23mA	Ca. 5mA	Ca. 95mA	Ca 56mA	Ca 56mA	-
Internal EMC filter disabled	Ca. 0.1mA	Ca. 0.1mA	Ca. 0.1mA	Ca. 0.1mA	Ca. 0.2mA	Ca. 0.2mA	Ca 0.2mA	Ca. 0.2mA	Ca. 0.2mA

(3) Applicable peripheral equipment

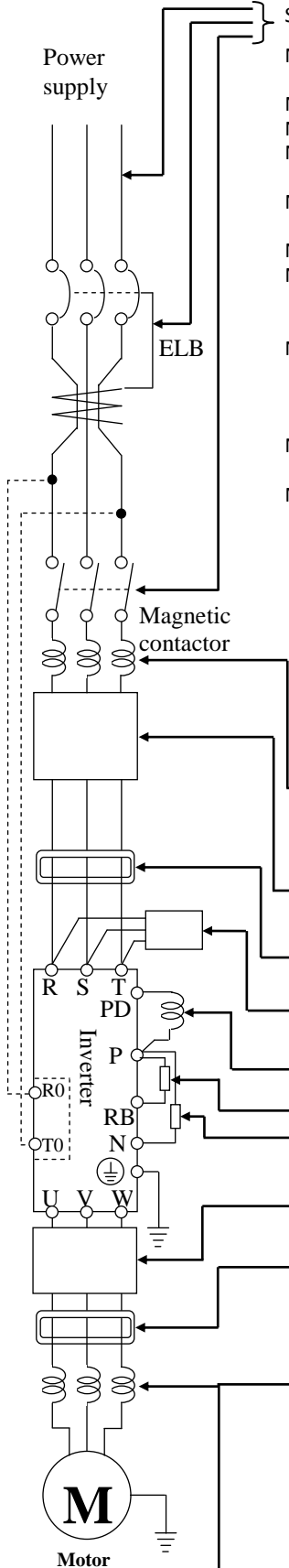

- See Item (4), "Recommended cable gauges, wiring accessories, and crimp terminals."
- Note 1: The peripheral equipment described here is applicable when the inverter connects a standard Hitachi 3-phase, 4-pole squirrel-cage motor.
 - Note 2: Select breakers that have proper capacity. (Use breakers that comply with inverters.)
 - Note 3: Use earth-leakage breakers (ELB) to ensure safety.
 - Note 4: Use copper electric wire (HIV cable) of which the maximum allowable temperature of the insulation is 75°C.
 - Note 5: If the power line exceeds 20 m, cable that is thicker than the specified applicable cable must be used for the power line.
 - Note 6: Use a 0.75 mm² cable to connect the alarm output contact.
 - Note 7: Tighten each terminal screw with the specified tightening torque. Loose terminal screws may cause short circuits and fire. Tightening a terminal screw with excessive torque may cause damage to the terminal block or inverter body.
 - Note 8: Select an earth-leakage breaker (ELB) of which the rated sensitivity current matches the total length of cables connected between the inverter and power supply and between the inverter and motor. Do not use a high-speed type ELB but use a delayed-type ELB because the high-speed type may malfunction.
 - Note 9: When a CV cable is used for wiring through a metal conduit, the average current leakage is 30 mA/km.
 - Note 10: When an IV cable, which has a high relative dielectric constant, is used, the leakage current is about eight times as high as the standard cable. Therefore, when using an IV cable, use the ELB of which the rated sensitivity current is eight times as high as that given in the table below. If the total cable length exceeds 100 m, use a CV cable.

Total cable length	Sensitivity current (mA)
100 m or less	50
300 m or less	100

Name	Description
Reactor on input side (for harmonic control, power supply coordination, and power factor improvement) (ALI-XXX)	Use this reactor to control harmonic waves or when the imbalance of power supply voltage is 3% or more, when the power supply capacity is 500 kVA or more, or when the power voltage may change rapidly. This reactor also improves the power factor.
Noise filter for inverter (NF-XXX)	This noise filter reduces the conductive noise that is generated by the inverter and transmitted in cables. Connect this noise filter to the primary side (input side) of the inverter.
Radio noise filter (Zero-phase reactor) (ZCL-X)	The inverter may generate radio noise through power supply wiring during operation. Use this noise filter to reduce the radio noise (radiant noise).
Radio noise filter on input side (Capacitor filter) (CFI-X)	Use this noise filter to reduce the radiant noise radiated from input cables.
DC reactor (DCL-X-XX)	Use this reactor to control the harmonic waves generated by the inverter.
Braking resistor Regenerative braking unit	Use these devices to increase the braking torque of the inverter for operation in which the inverter turns the connected load on and off very frequently or decelerates the load running with a high moment of inertia.
Noise filter on the output side (ACF-CX)	Connect this noise filter between the inverter and motor to reduce the radiant noise radiated from cables for the purpose of reducing the electromagnetic interference with radio and television reception and preventing malfunctions of measuring equipment and sensors.
Radio noise filter (Zero-phase reactor) (ZCL-XXX)	Use this noise filter to reduce the noise generated on the output side of the inverter. (This noise filter can be used on both the input and output sides.)
AC reactor for the output side For reducing vibrations and preventing thermal relay malfunction (ACL-X-XX)	Using the inverter to drive a general-purpose motor may cause larger vibrations of the motor when compared with driving it directly with the commercial power supply. Connect this AC reactor between the inverter and motor to lessen the pulsation of motor. Also, connect this AC reactor between the inverter and motor, when the cable length between them is long (10 m or more), to prevent thermal relay malfunction due to the harmonic waves that are generated by the switching operation on the inverter. Note that the thermal relay can be replaced with a current sensor to avoid the malfunction.
LCR filter	Connect this noise filter between the inverter and motor to convert the inverter output into a sinusoidal waveform and to reduce the motor vibration, motor noise and the radiant noise radiated from cables.

(4) Recommended cable gauges, wiring accessories, and crimp terminals

Note: For compliance with CE and UL standards, see the safety precautions concerning EMC and the compliance with UL and cUL standards under Safety Instructions.

The table below lists the specifications of cables, crimp terminals, and terminal screw tightening torques for reference.

	Motor output (kW)	Applicable inverter model	Gauge of power line cable (mm ²) (Terminals: R, S, T, U, V, W, P, PD, and N)	Grounding cable (mm ²)	External braking resistor across terminals P and RB (mm ²)	Size of terminal screw	Crimp terminal	Tightening torque (N·m)	Applicable device	
									Earth-leakage breaker (ELB)	Magnetic contactor (MC)
200 V class	0.4	SJ700D-004L***3	1.25	1.25	1.25	M4	1.25-4	1.2(MAX1.8)	EX50B(5A)	HS10
	0.75	SJ700D-007L***3	1.25	1.25	1.25	M4	1.25-4	1.2(MAX1.8)	EX50B(10A)	HS10
	1.5	SJ700D-015L***3	2	2	2	M4	2-4	1.2(MAX1.8)	EX50B(15A)	HS10
	2.2	SJ700D-022L***3	2	2	2	M4	2-4	1.2(MAX1.8)	EX50B(20A)	HS20
	3.7	SJ700D-037L***3	3.5	3.5	3.5	M4	3.5-4	1.2(MAX1.8)	EX50B(30A)	HS20
	5.5	SJ700D-055L***3	5.5	5.5	5.5	M5	R5.5-5	2.4(MAX4.0)	EX50B(50A)	HS25
	7.5	SJ700D-075L***3	8	8	8	M5	R8-5	2.4(MAX4.0)	EX60(60A)	HS35
	11	SJ700D-110L***3	14	14	14	M6	R14-6	4.0(MAX4.4)	RXK100-H(75A)	HS50
	15	SJ700D-150L***3	22	22	22	M6	22-6	4.5(MAX4.9)	RXK100-H(100A)	H65C
	18.5	SJ700D-185L***3	30	22	30	M6	38-6	4.5(MAX4.9)	RXK100-H(100A)	H80C
	22	SJ700D-220L***3	38	30	38	M8	38-8	8.1(MAX8.8)	RXK225-H(150A)	H100C
	30	SJ700D-300L***3	60(22×2)	30	—	M8	60-8	8.1(MAX8.8)	RXK225-H(200A)	H125C
	37	SJ700D-370L***3	100(38×2)	38	—	M8	100-8	8.1(MAX20)	RXK225-H(225A)	H150C
	45	SJ700D-450L***3	100(38×2)	38	—	M8	100-8	8.1(MAX20)	RXK225-H(225A)	H200C
55	SJ700D-550L***3	150(60×2)	60	—	M10	150-10	19.5(MAX22)	RX400B(350A)	H250C	
400 V class	0.75	SJ700D-007H***3	1.25	1.25	1.25	M4	1.25-4	1.2(MAX1.8)	EX50C(5A)	HS10
	1.5	SJ700D-015H***3	2	2	2	M4	2-4	1.2(MAX1.8)	EX50C(10A)	HS10
	2.2	SJ700D-022H***3	2	2	2	M4	2-4	1.2(MAX1.8)	EX50C(10A)	HS10
	3.7	SJ700D-037H***3	2	2	2	M4	2-4	1.2(MAX1.8)	EX50C(15A)	HS20
	5.5	SJ700D-055H***3	3.5	3.5	3.5	M5	R2-5	2.4(MAX4.0)	EX50C(30A)	HS20
	7.5	SJ700D-075H***3	3.5	3.5	3.5	M5	3.5-5	2.4(MAX4.0)	EX50C(30A)	HS25
	11	SJ700D-110H***3	5.5	5.5	5.5	M6	R5.5-6	4.0(MAX4.4)	EX50C(50A)	HS35
	15	SJ700D-150H***3	8	8	8	M6	8-6	4.5(MAX4.9)	EX60B(60A)	HS35
	18.5	SJ700D-185H***3	14	14	14	M6	14-6	4.5(MAX4.9)	EX60B(60A)	HS50
	22	SJ700D-220H***3	14	14	14	M6	14-6	4.5(MAX4.9)	RXK100-H(75A)	HS50
	30	SJ700D-300H***3	22	22	—	M6	22-6	4.5(MAX4.9)	RXK100-H(100A)	H65C
	37	SJ700D-370H***3	38	22	—	M8	38-8	8.1(MAX20)	RXK100-H(100A)	H80C
	45	SJ700D-450H***3	38	22	—	M8	38-8	8.1(MAX20)	RXK225-H(150A)	H100C
	55	SJ700D-550H***3	60	30	—	M8	R60-8	8.1(MAX20)	RXK225-H(175A)	H125C
	75	SJ700D-750H***3	100(38×2)	38	—	M10	100-10	20.0(MAX22)	RXK225-H(225A)	H150C
	90	SJ700D-900H***3	100(38×2)	38	—	M10	100-10	20.0(MAX22)	RXK225-H(225A)	H200C
110	SJ700D-1100H***3	150(60×2)	60	—	M10	150-10	20.0(MAX35)	RX400B(350A)	H250C	
132	SJ700D-1320HFF3 SJ700D-1320HFEF3	80×2	80	—	M10	80-10	20.0(MAX35)	RX400B(350A)	H300C	
150	SJ700D-1500HFUF3	80×2	80	—	M10	80-10	20.0(MAX35)	RX400B(350A)	H300C	

Note: Cable gauges indicate those of HIV cables (maximum heat resistance: 75°C).

Note: *** is described as FF, FEF or FUF.

Note: Please use the round type crimp terminals (for the UL standard) suitable for the use electric wire when you connect the electric wire with the main circuit terminal stand. Please put on pressure to the crimp terminals I with a crimp tool that the terminal stand maker recommends.

(5) Connecting the control circuit to a power supply separately from the main circuit.

If the protective circuit of the inverter operates to open the magnetic contactor in the input power supply circuit, the inverter control circuit power is lost, and the alarm signal cannot be retained. To retain the alarm signal, connect control circuit terminals R0 and T0 to a power supply. In details, connect the control circuit power supply terminals R0 and T0 to the primary side of the magnetic contactor as shown below.

(Connection method)

Power-receiving specifications

200 V class model:

200 to 240 V (+10%, -15%)

(50/60 Hz $\pm 5\%$), (282 to 339 VDC)

400 V class model:

380 to 480 V (+10%, -15%)

(50/60 Hz $\pm 5\%$), (537 to 678 VDC)

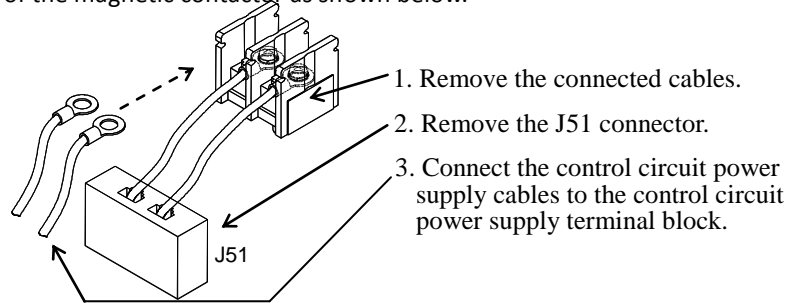

1. Remove the connected cables.

2. Remove the J51 connector.

3. Connect the control circuit power supply cables to the control circuit power supply terminal block.

Note the following when connecting separate power supplies to control circuit power supply terminals (R0 and T0) and main circuit power supply terminals (R, S, and T):

- Use a cable thicker than 1.25 mm^2 to connect the terminals R0 and T0 (terminal screw size: M4).
- Connect a 3A fuse in the control circuit power supply line. (Tightening torque: 1.2Nm, max torque: 1.4Nm)
- If the control circuit power supply (connected to R0 and T0) is turned on earlier than the main circuit power supply (connected to R, S, and T), ground fault is not checked at power-on.
- When supplying DC power to the control circuit power supply terminals (R0 and T0), specify "00" as the "a/b (NO/NC)" selection (function code C031 to C036) for intelligent output terminals ([11] to [15]) and intelligent relay terminals (AL0, AL1, and AL2). If "01" is specified as the "a/b (NO/NC)" selection, output signals may chatter when the DC power supply is shut off.

2.2.3 Wiring of the control circuit

(1) Wiring instructions

- 1) Terminals L and CM1 are common to I/O signals and isolated from each other.
Do not connect these common terminals to each other or ground them.
Do not ground these terminals via any external devices. (Check that the external devices connected to these terminals are not grounded.)
- 2) Use a shielded, twisted-pair cable (recommended gauge: 0.75 mm²) for connection to control circuit terminals, and connect the cable insulation to the corresponding common terminal. (Tightening torque: 0.7Nm, max torque: 0.8Nm)
- 3) The length of cables connected to control circuit terminals must be 20 m or less. If the cable length exceeds 20 m unavoidably, you should use UP/DOWN function or current signal input with an isolation amplifier.
- 4) Separate the control circuit wiring from the main circuit wiring (power line) and relay control circuit wiring. If these wirings intersect with each other unavoidably, square them with each other. Otherwise, the inverter may malfunction.
- 5) Twist the cables connected from a thermistor to the thermistor input terminal (TH) and terminal CM1, and separate the twisted cables from other cables connected to other common terminals. Since very low current flows through the cables connected to the thermistor, separate the cables from those (power line cables) connected to the main circuit. The length of the cables connected to the thermistor must be 20 m or less.

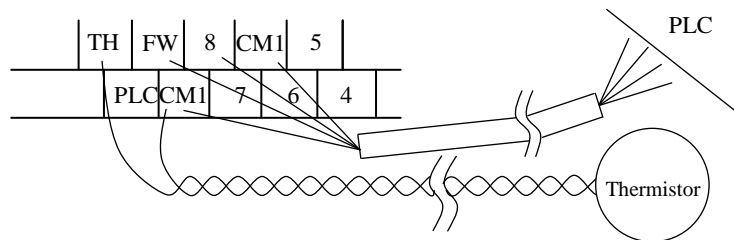

- 6) When connecting a contact to a control circuit terminal (e.g., an intelligent input terminal), use a relay contact (e.g., crossbar twin contact) in which even a very low current or voltage will not trigger any contact fault.
- 7) When connecting a relay to an intelligent output terminal, also connect a surge-absorbing diode in parallel with the relay.
- 8) Do not connect analog power supply terminals H and L or interface power supply terminals P24 and CM1 to each other. Otherwise, the inverter may fail.

(2) Layout of control circuit terminals

H	O2	AM	FM	TH	FW	8	CM1	5	3	1	14	13	11	AL1	
L	O	OI	AMI	P24	PLC	CM1	7	6	4	2	15	CM2	12	AL0	AL2

Terminal screw size: M3 (Tightening torque:0.7Nm,max torque:0.8Nm)

(3) Switching the input control logic

- In the factory setting, the input control logic for terminal FW and intelligent input terminals is the sink logic.
To switch the input control logic to the source logic, remove the jumper connecting terminals P24 and PLC on the control circuit block, and then connect terminals PLC and CM1 with the jumper.

(4) Connecting a programmable controller to intelligent input terminals

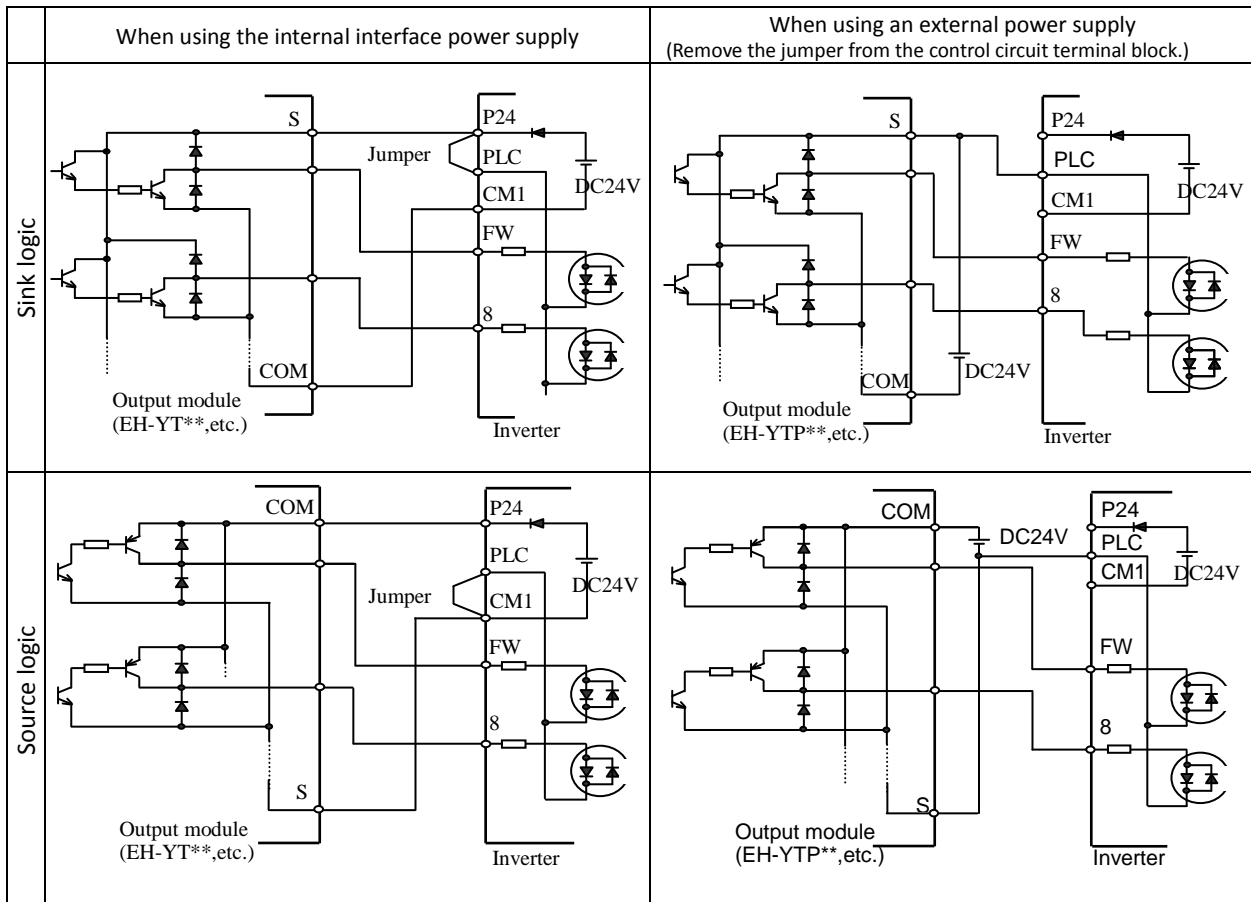

(5) Connecting a programmable controller to intelligent output terminals

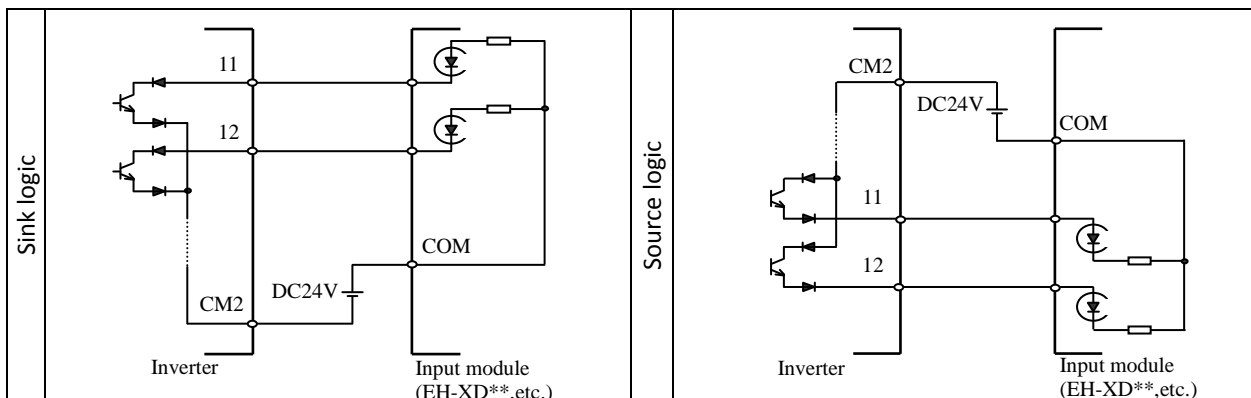
**2.2.4 Wiring of the digital operator**

- You can operate the inverter with not only the digital operator mounted in the inverter as standard equipment but also an optional digital operator (OPE-S, OPE-SR, WOP).
- When you intend to remove the standard digital operator from the inverter and use it as remote equipment, request your local Hitachi Distributor to supply a connection cable, ICS-1 (1-meter cable) or ICS-3 (3-meter cable). If you prepare the cable by yourself, the following product is recommended:
HUTP5 PC 4P -X-X: Straight cable equipped with connector at both ends (made by Hitachi Metal, Ltd.)
- The length of the connection cable must be 3 m or less. If a cable over 3 m is used, the inverter may malfunction.

2.2.5 Selection and wiring of dynamic braking resistor (on 0.4 kW to 22 kW models)

The SJ700D-3 series inverter models with capacities of 0.4 to 22 kW have an internal dynamic braking circuit. Connecting an optional dynamic braking resistor to RB and P terminals increases the braking torque.

Model SJ700D-**** FF/FEF/FUF3	Motor capacity (kW)	Without a resistor connected	With a resistor connected		Minimum connectable resistor		Minimum resistance during continuous operation (Ω)
		Braking torque (%)	Resistance of connected resistor (Ω)	Braking torque (%)	Resistance (Ω)	BRD usage rate (%)	
004L	0.4	20	48	150 over	48	10	150
007L	0.75	20	48	150 over	48	10	150
015L	1.5	20	32	150 over	32	10	100
022L	2.2	20	32	150 over	32	10	100
037L	3.7	20	32	110	32	10	100
055L	5.5	20	16	140	16	10	50
075L	7.5	20	10	150 over	10	10	50
110L	11	10	10	110	10	10	50
150L	15	10	7.5	110	7.5	10	35
185L	18.5	10	7.5	90	7.5	10	35
220L	22	10	5	110	5	10	35
007H	0.75	20	100	150 over	70	10	300
015H	1.5	20	100	150 over	70	10	300
022H	2.2	20	100	150 over	70	10	300
037H/040H	3.7	20	70	150 over	70	10	200
055H	5.5	20	70	130	70	10	200
075H	7.5	20	70	150 over	35	10	150
110H	11	10	50	130	35	10	150
150H	15	10	35	140	24	10	100
185H	18.5	10	35	140	24	10	100
220H	22	10	35	110	20	10	100

(Memo)

Chapter 3 Operation

This chapter describes typical methods of operating the inverter, how to operate the digital operator, and how to make a test run of the inverter.

3.1 Operating Methods.....	3 - 1
3.2 How To Operate the Digital Operator (OPE-SBK).....	3 - 3
3.3 How To Make a Test Run	3 - 10
3.4 How To Make a Test Run	3 - 13
3.5 Basic Parameter Setting to Drive Motor	3 - 17
3.6 Selecting the control mode.....	3 - 22

3.1 Operating Methods



WARNING

- While power is supplied to the inverter, do not touch any terminal or internal part of the inverter, check signals, or connect or disconnect any wire or connector. Otherwise, you run the risk of electric shock or fire.
- Be sure to close the terminal block cover before turning on the inverter power. Do not open the terminal block cover while power is being supplied to the inverter or voltage remains inside. Otherwise, you run the risk of electric shock.
- Do not operate switches with wet hands. Otherwise, you run the risk of electric shock.
- While power is supplied to the inverter, do not touch the terminal of the inverter, even if it has stopped. Otherwise, you run the risk of injury or fire.
- If the retry mode has been selected, the inverter will restart suddenly after a break in the tripping status. Stay away from the machine controlled by the inverter when the inverter is under such circumstances. (Design the machine so that human safety can be ensured, even when the inverter restarts suddenly.) Otherwise, you run the risk of injury.
- Do not select the retry mode for controlling an elevating or traveling device because output free-running status occurs in retry mode. Otherwise, you run the risk of injury or damage to the machine controlled by the inverter.
- If an operation command has been input to the inverter before a short-term power failure, the inverter may restart operation after the power recovery. If such a restart may put persons in danger, design a control circuit that disables the inverter from restarting after power recovery. Otherwise, you run the risk of injury.
- The [STOP] key is effective only when its function is enabled by setting. Prepare an emergency stop switch separately. Otherwise, you run the risk of injury.
- If an operation command has been input to the inverter before the inverter enters alarm status, the inverter will restart suddenly when the alarm status is reset. Before resetting the alarm status, make sure that no operation command has been input.
- While power is supplied to the inverter, do not touch any internal part of the inverter or insert a bar in it. Otherwise, you run the risk of electric shock or fire.



CAUTION

- Do not touch the heat sink, which heats up during the inverter operation. Otherwise, you run the risk of burn injury.
- The inverter allows you to easily control the speed of motor or machine operations. Before operating the inverter, confirm the capacity and ratings of the motor or machine controlled by the inverter. Otherwise, you run the risk of injury and damage to machine.
- Install an external brake system if needed. Otherwise, you run the risk of injury.
- When using the inverter to operate a standard motor at a frequency of over 60 Hz, check the allowable motor speeds with the manufacturers of the motor and the machine to be driven and obtain their consent before starting inverter operation. Otherwise, you run the risk of damage to the motor and machine and injury.
- During inverter operation, check the motor for the direction of rotation, abnormal sound, and vibrations. Otherwise, you run the risk of damage to the machine driven by the motor.

You can operate the inverter in different ways, depending on how to input the operation and frequency-setting commands as described below.

This section describes the features of operating methods and the items required for operation.

(1) Entering operation and frequency-setting commands from the digital operator

This operating method allows you to operate the inverter through key operations on the standard digital operator mounted in the inverter or an optional digital operator.

When operating the inverter with a digital operator alone, you need not wire the control circuit terminals.

(Items required for operation)

*) Optional digital operator (not required when you use the standard digital operator)

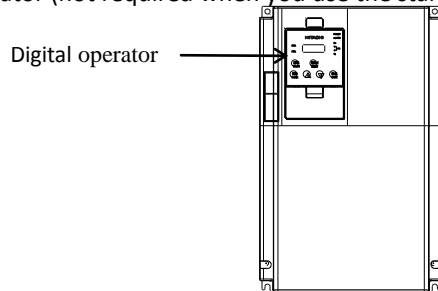

(2) Entering operation and frequency-setting commands via control circuit terminals

This operating method allows you to operate the inverter via the input of operation signals from external devices (e.g., frequency-setting circuit and start switch) to control circuit terminals. The inverter starts operation when the input power supply is turned on and then an operation command signal (FW or RV) is turned on. You can select the frequency-setting method (setting by voltage specification or current specification) through the input to a control circuit terminal according to your system. For details, see Item (2), "Explanation of control circuit terminals," in Section 2.2.1. (Items required for operation)

1) Operation command input device: External switch or relay

2) Frequency-setting command input device: External device to input signals (0 to 10 VDC, -10 to +10 VDC, or 4 to 20 mA)

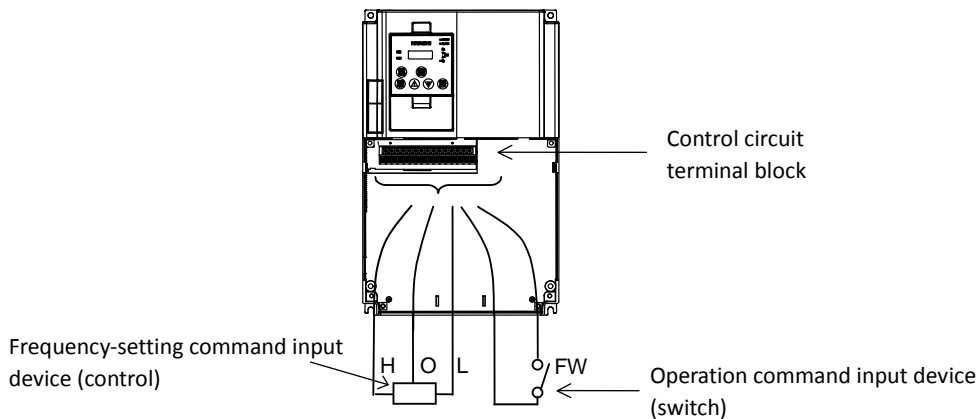

(3) Entering operation and frequency-setting commands; both from a digital operator and via control circuit terminals

This operating method allows you to arbitrarily select the digital operator or control circuit terminals as the means to input operation commands and frequency-setting commands. (Items required for operation)

1) See the items required for the above two operating methods.

(4) Operation by Easy sequence function (Drive programming function)

The inverter can be operated by downloading the user's program made with the dedicated PC software, ProDriveNext. Please refer to "Easy sequence function" for details.

(5) Operation via communication

The inverter can be operated by an external communication device via Modbus-RTU or ASCII protocol (Hitachi protocol) through the TM2 terminal on the control terminal I board. Please refer to "Communication function" for details.

3.2 How To Operate the Digital Operator (OPE-SBK)

3.2.1 Names and functions of components

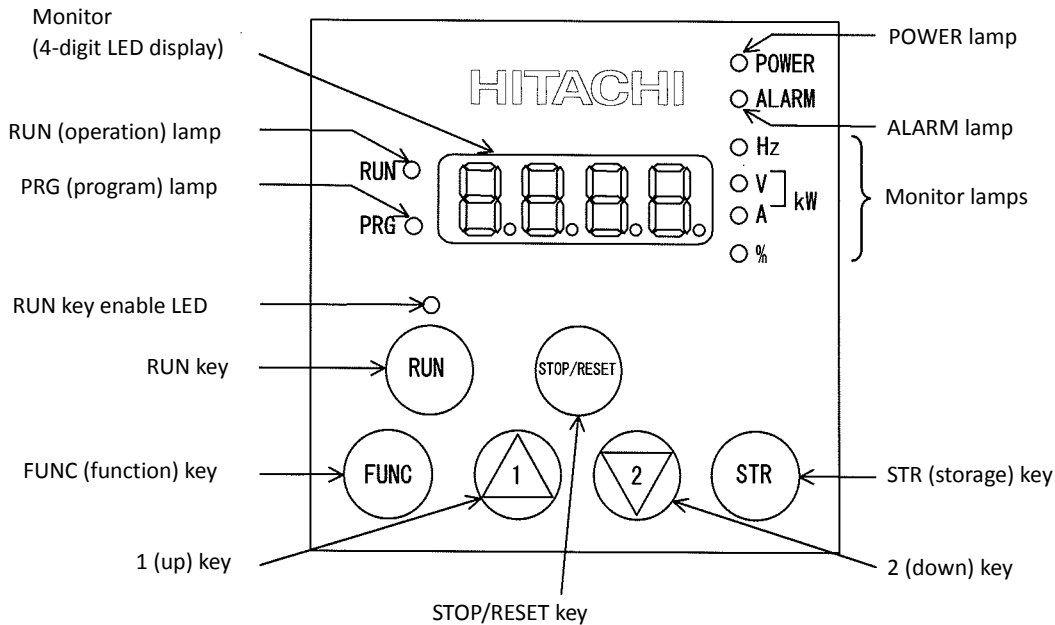



Name	Function
POWER lamp	Lights when the control circuit power is on.
ALARM lamp	Lights to indicate that the inverter has tripped.
RUN (operation) lamp	Lights to indicate that the inverter is operating.
PRG (program) lamp	Lights when the monitor shows a value set for a function. This lamp starts blinking to indicate a warning (when the set value is invalid).
Monitor	Displays a frequency, output current, or set value.
Monitor lamps	Indicates the type of value and units displayed on the monitor. "Hz" (frequency), "V" (voltage), "A" (current), "kW" (electric power), and "%" (percentage)
RUN key enable LED	Lights up when the inverter is ready to respond to the RUN key. (When this lamp is on, you can start the inverter with the RUN key on the digital operator.)
RUN key	Starts the inverter to run the motor. This key is effective only when the RUN command source setting A002 is set to "02": digital operator. (To use this key, confirm that RUN key enable LED is on.)
STOP/RESET key	Decelerates and stops the motor or resets the inverter from alarm status.
FUNC (function) key	Makes the inverter enter the monitor, function, or extended function mode.
STR (storage) key	Stores each set value. (Always press this key after changing a set value.)
1 (up) or 2 (down) key	Switches the inverter operation mode (among monitor, function, and extended function modes) or increases or decreases the value set on the monitor for a function.

3.2.2 Code display system and key operations



This section describes typical examples of digital operator operation (in basic and full display modes) and an example of special digital operator operation in extended function mode U.

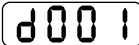

The initial display on the monitor screen after power-on depends on the setting of function "b038". For details, see Section 4.2.85, "Initial-screen selection," (on page 4-78).

When the setting of function "b038" is "01" (factory setting), the monitor initially shows  as the setting of function "d001" (output frequency monitoring). Pressing the  key in this status changes the display to .

Note: The display contents on the monitor depend on the settings of functions "b037" (function code display restriction), "b038" (initial-screen selection), and "b039" (automatic setting of user parameters). For details, see Sections 4.2.84, "Function code display restriction," (on page 4-76), 4.2.85, "Initial-screen selection," (on page 4-78), and 4.2.86, "Automatic user-parameter setting," (on page 4-79).

Function name	Code	Default	
Function code display restriction	b037	00	Full display
Initial-screen selection	b038	01	d001(Output frequency monitoring)
Automatic user-parameter setting function enable	b039	00	Disabling

note: The following procedure enables you to turn the monitor display back to  (*), displaying , regardless of the current display mode:

- Hold down the  key for 3 seconds or more. The monitor shows  (*) alternately.

* The monitor shows  only when the motor driven by the inverter is stopped. While the motor is running, the monitor shows an output frequency. The displayed monitor depends on "b038" (initial-screen selection).

(1) Example of operation in full display mode ("b037" = "00" [factory setting])

All parameters can be displayed in full display mode. The display sequence of parameters matches their sequence shown in Chapter 8, "List of Data Settings."

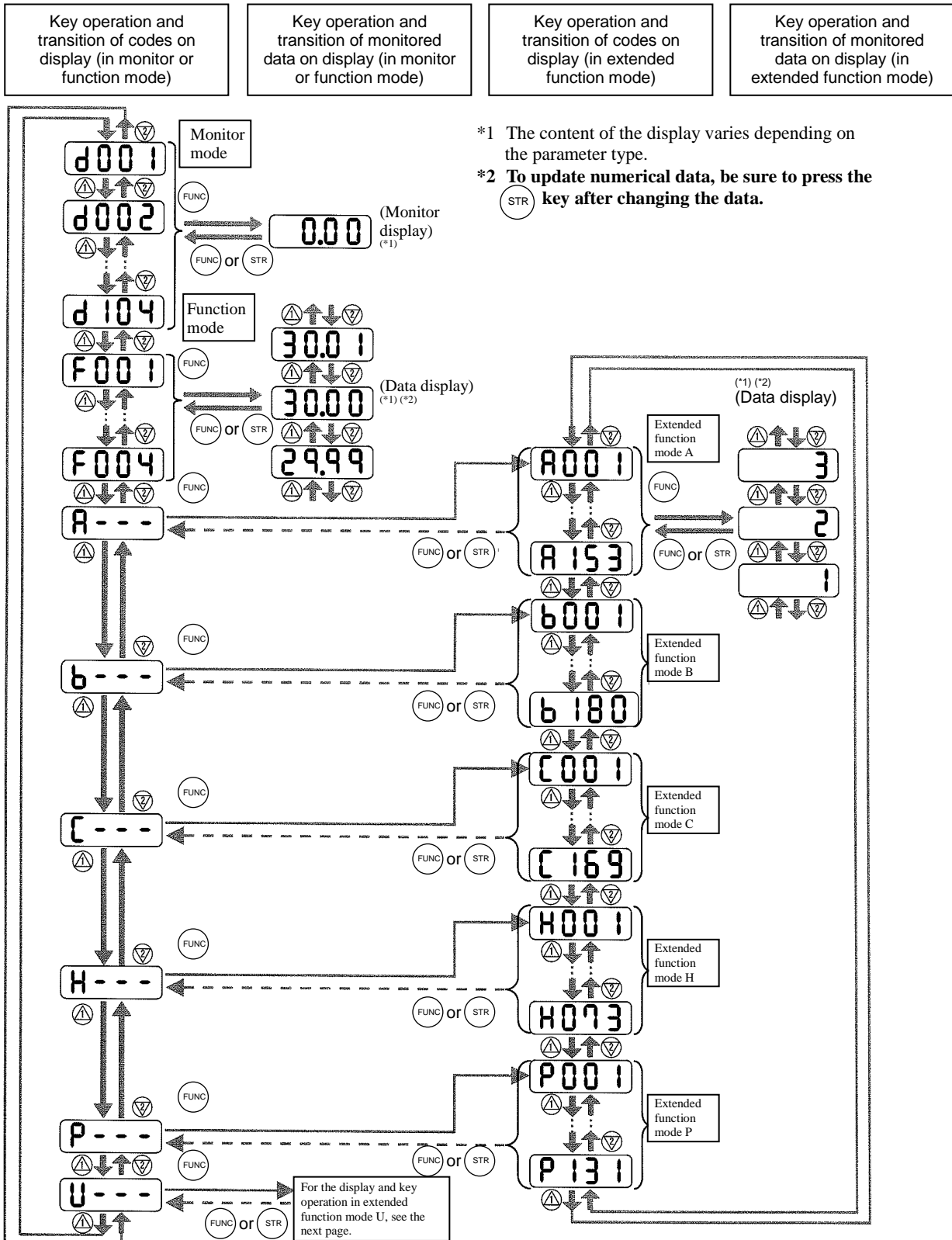

- *1 The content of the display varies depending on the parameter type.
- *2 To update numerical data, be sure to press the **STR** key after changing the data.

Pressing the **1** or **2** key respectively scrolls up or down the code displayed in code display mode or increases or decreases the numerical data displayed in data display mode.

Press the **1** or **2** key until the desired code or numerical data is shown. To scroll codes or increase/decrease numerical data fast, press and hold the key.

(2) Code/data display and key operation in extended function mode U

The extended function mode U differs in operation from other extended function modes because the extended function mode U is used to register (or automatically record) other extended-function codes as user-specified U parameters.

Key operation and transition of codes on display (in monitor or function mode)

Key operation and transition of codes on display (in extended function mode U)

Key operation and transition of codes on display (when displaying extended-function mode parameters from the extended function mode U)

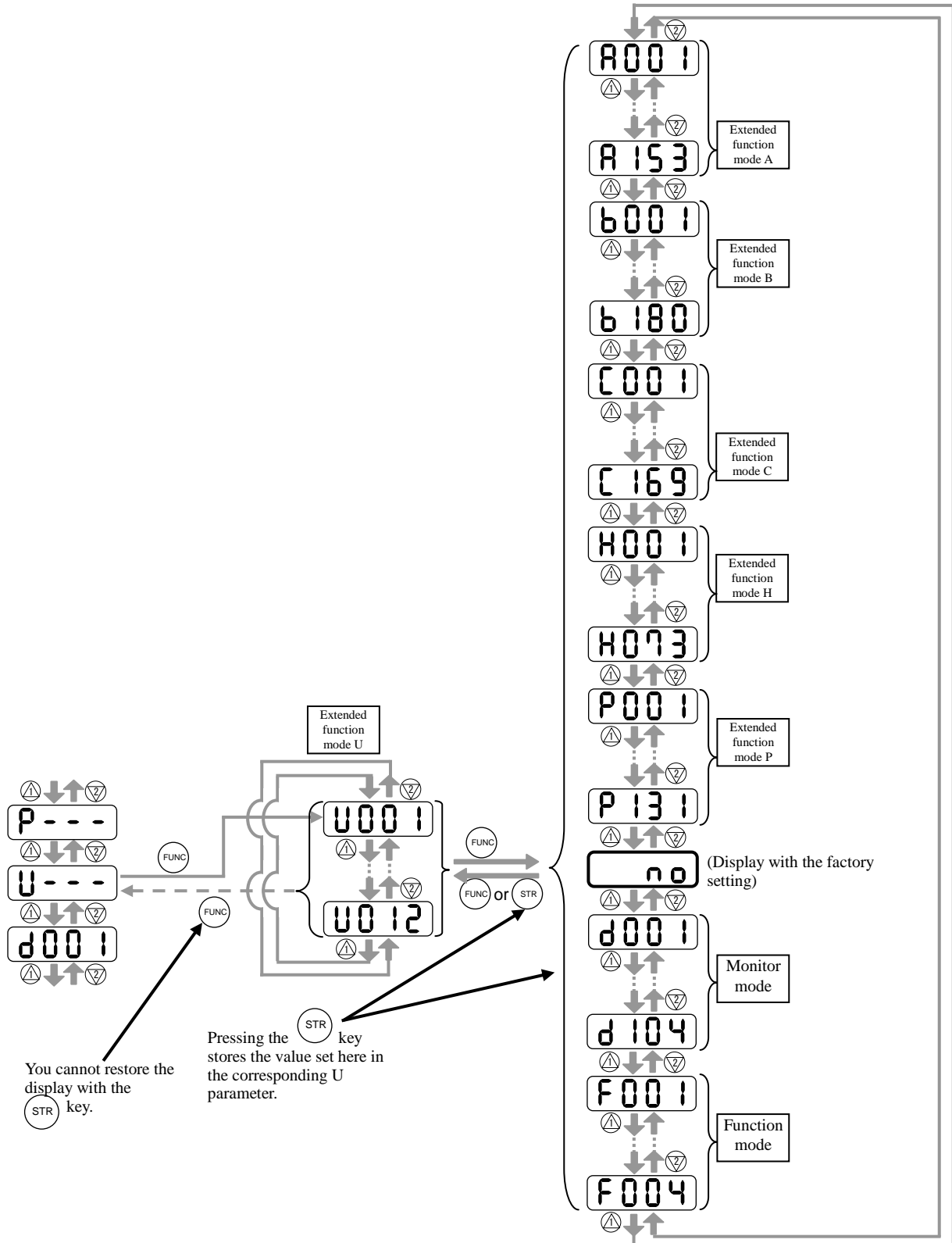

(3) Example of operation in basic display mode ("b037" = "04")

- Only basic parameters can be displayed in basic display mode. (All parameters in monitor mode, four parameters in function mode, or 20 parameters in extended function mode)
- Other parameters are not displayed. To display all parameters, select the full display mode ("b037" = "00").

<Displayable parameters and sequence of display>

No.	Display code	Item
1	d001 to d104	Monitor display
2	F001	Output frequency setting
3	F002	Acceleration (1) time setting
4	F003	Deceleration (1) time setting
5	F004	Operation direction setting
6	A001	Frequency source setting
7	A002	Run command source setting
8	A003	Base frequency setting
9	A004	Maximum frequency setting
10	A005	[AT] selection
11	A020	Multispeed frequency setting
12	A021	Multispeed 1 setting
13	A022	Multispeed 2 setting
14	A023	Multispeed 3 setting
15	A044	1st control method
16	A045	V/f gain setting
17	A085	Operation mode selection
18	b001	Selection of restart mode
19	b002	Allowable under-voltage power failure time
20	b008	Retry-after-trip selection
21	b011	Retry wait time after trip
22	b037	Function code display restriction
23	b083	Carrier frequency setting
24	b084	Initialization mode selection
25	b130	Selection of overvoltage suppression function
26	b131	Setting of overvoltage suppression level
27	C021	Setting of intelligent output terminal 11
28	C022	Setting of intelligent output terminal 12
29	C036	Alarm relay active state

Note:

If a desired parameter is not displayed, check the setting of function "b037" (function code display restriction). To display all parameters, specify "00" for "b037".

Key operation and transition of the codes on display

Key operation and transition of the monitored data on display

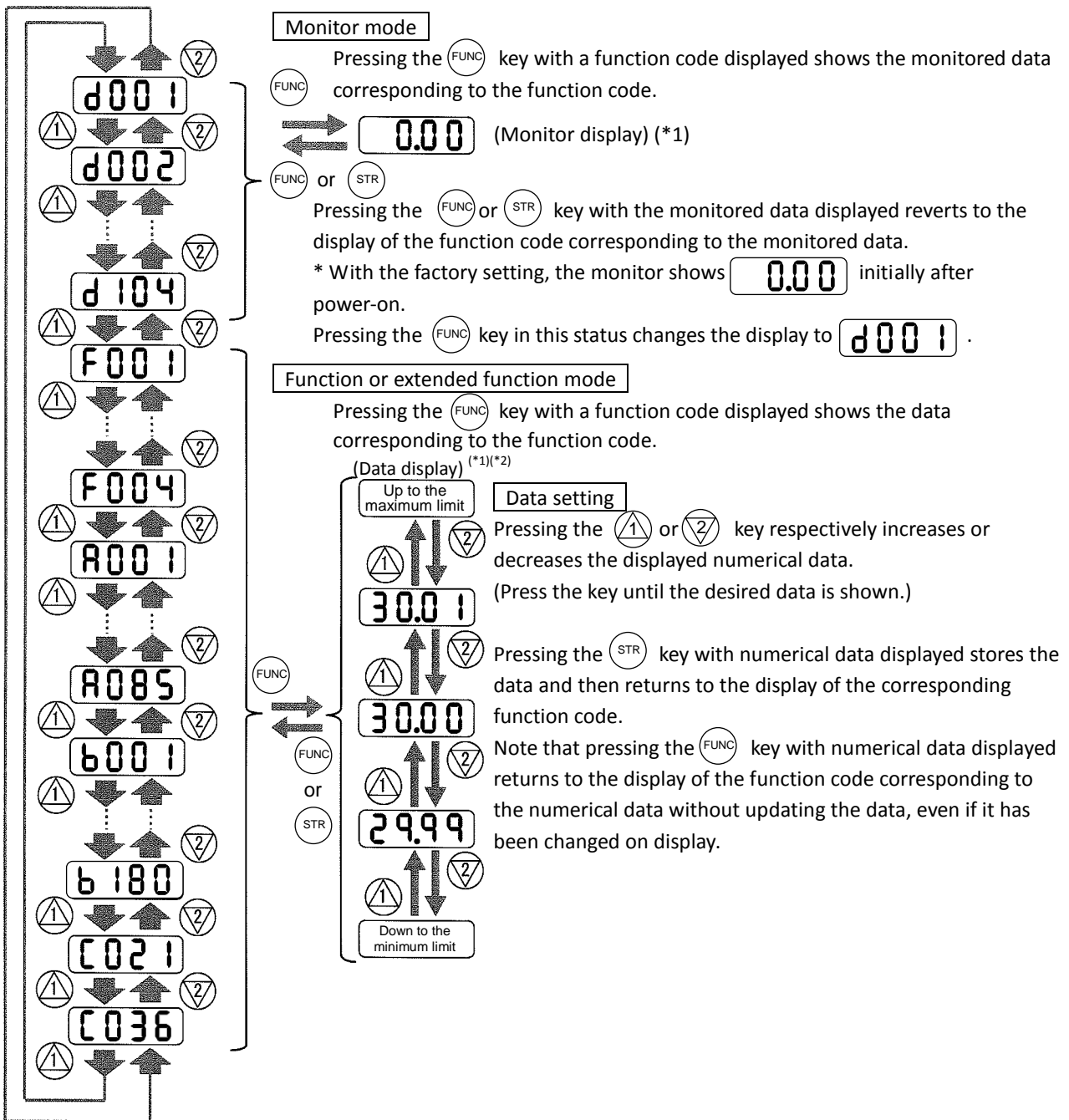

Pressing the **1** or **2** key respectively scrolls up or down the code displayed in code display mode or increases or decreases the numerical data displayed in data display mode.

Press the **1** or **2** key until the desired code or numerical data is shown. To scroll codes or increase/decrease numerical data fast, press and hold the key.

(4) Procedure for directly specifying or selecting a code

- You can specify or select a code or data by entering each digit of the code or data instead of scrolling codes or data in the monitor, function, or extended function mode.
- The following shows an example of the procedure for changing the monitor mode code "d001" displayed to extended function code "A029":

1) Display the monitor mode code.
("d001" is displayed.)

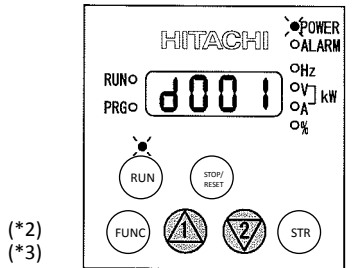

(*2)
(*3)
Press the Δ and ∇ keys together. (*1)

2) Change to the extended function mode.

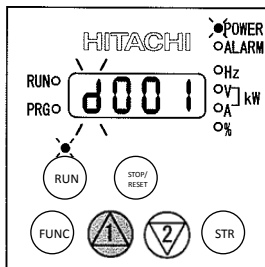

- Character "d" in the leftmost digit (fourth digit from the right) starts blinking.

Press the Δ key twice.
("A001" is displayed.)

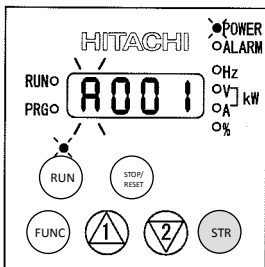

- Character "A" is blinking.
- Pressing the [STR] key determines the blinking character.

(*2)
Press the STR key (to determine character "A").

3) Change the third digit of the code.

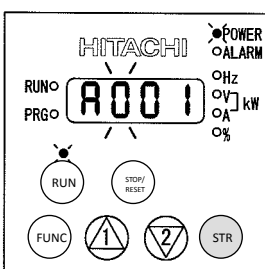

- Character "0" in the third digit is blinking.
- Since the third digit need not be changed, press the [STR] key to determine the character "0".

Press the STR key.
(Character "0" is determined.)

(*2)

6) End the change of the extended function code.

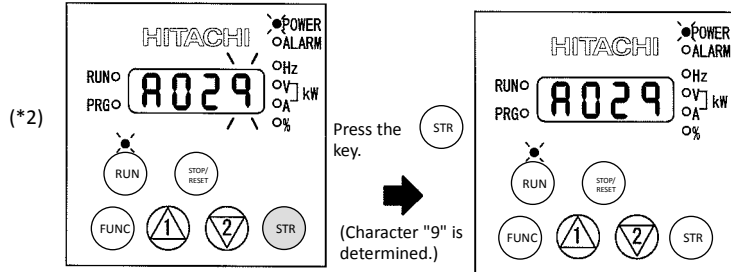

(*2)
Press the STR key.
(Character "9" is determined.)

- Character "9" in the first digit is blinking.

Press the Δ key eight times or the ∇ key twice.

5) Change the first digit of the code.

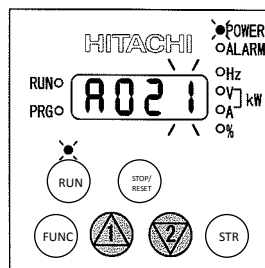

- Character "1" in the first digit is blinking.

(*2)
Press the STR key.
("A021" is displayed.)

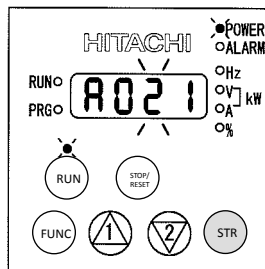

- Character "2" in the second digit is blinking.

Press the Δ key twice.

4) Change the second digit of the code.

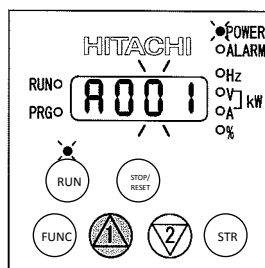

- Character "0" in the second digit is blinking.

- Selection of code "A029" is completed.

* If a code that is not defined in the code list or not intended for display is entered, the leftmost digit (fourth digit) (character "A" in this example) will start blinking again.

In such a case, confirm the code to be entered and enter it correctly. For further information, refer to Section 4.2.80. "Function code display restriction," (on page 4-74), Section 4.2.81. "Initial-screen selection," (on page 4-76), Section 4.2.82. "Automatic user-parameter setting," (on page 4-77), and Chapter 8, "List of Data Settings."

7) Press the FUNC key to display the data corresponding to the function code, change the data with the Δ and/or ∇ key, and then press the STR key to store the changed data. (*4)

Note that you can also use the procedure (steps 1) to 6) described here to change the data. (*3)(*4)

*1 This procedure can also be used on screens displaying a code other than "d001".

*2 If the FUNC key is pressed while a digit is blinking, the display will revert to the preceding status for entering the digit to the right of the blinking digit.

*3 If the FUNC key is pressed while the leftmost (fourth) digit is blinking, the characters having been entered to change the code will be cancelled and the display will revert to the original code shown before the Δ and ∇ keys were pressed in step 1).

*4 When changing data, be sure to press the FUNC key first.

3.3 How To Make a Test Run

This section describes how to make a test run of the inverter that is wired and connected to external devices in a general way as shown below.





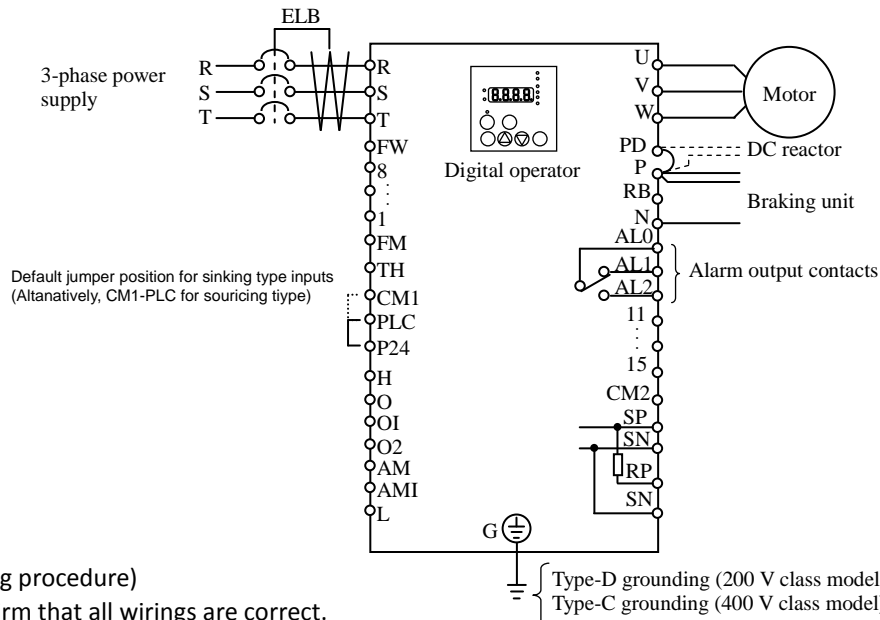





For the detailed method of using the digital operator, see Section 3.2, "How To Operate the Digital Operator."

- (1) When entering operation and frequency-setting commands from the digital operator:
(The operating procedure below is common to the standard and optional digital operators.)



(Operating procedure)

- 1) Confirm that all wirings are correct.
- 2) Turn on the earth-leakage breaker (ELB) to supply power to the inverter.
(The POWER lamp [red LED] of the digital operator goes on.)
* When using an inverter with the factory setting, proceed to step 5).
- 3) Select the digital operator as the operating device via the frequency source setting function.
 - Display the function code "A001" on the monitor screen, and then press the **(FUNC)** key once.
(The monitor shows a 2-digit numeric value.)
 - Use the **(1)** and/or **(2)** key to change the displayed numeric value to [02], and then press the **(STR)** key once to specify the digital operator as the operating device to input frequency-setting commands.
(The display reverts to [A001].)
- 4) Select the digital operator as the operating device by the run command source setting function.
 - Display the function code "A002" on the monitor screen, and then press the **(FUNC)** key once.
(The monitor shows a 2-digit numeric value.)
 - Use the **(1)** and/or **(2)** key to change the displayed numeric value to "02", and then press the **(STR)** key once to specify the digital operator as the operating device to input operation commands.
(The display reverts to [A002]. The operating device indicator lamp above the [RUN] key goes on.)
- 5) Set the output frequency.
 - Display the function code "F001" on the monitor screen, and then press the **(FUNC)** key once.
(The monitor shows a preset output frequency. With the factory setting, **0.00** [0 Hz] is shown.)
 - Use the **(1)** and/or **(2)** key to change the displayed numeric value to the desired output frequency, and then press the **(STR)** key once to determine the frequency.
(The display reverts to [F001].)
- 6) Set the operation direction of the motor.
 - Display the function code "F004" on the monitor screen, and then press the **(FUNC)** key once.
(The monitor shows "00" or "01".)

- Use the  and/or  key to change the displayed value to "00" for forward operation or "01" for reverse operation, and then press the  key once to determine the operation direction.
(The display reverts to [F004].)
- 7) Set the monitor mode.
- To monitor the output frequency, display the function code "d001", and then press the  key once.
(The monitor shows the output frequency.)
To monitor the operation direction, display the function code "d003", and then press the  key once.
(The monitor shows  for forward operation,  for reverse operation, or  for stopping.)
- 8) Press the  key to start the motor.
(The RUN lamp [green LED] goes on.)
- 9) Press the  key to decelerate or stop the motor.
(When the motor stops, the RUN lamp [green LED] goes off.)
- During the test run, confirm that the inverter does not trip while accelerating or decelerating the motor and that the motor speed and frequencies are correct.
 - If a trip due to overcurrent or overvoltage has occurred during the test run, increase the acceleration and deceleration time.
 - Make sure that there is enough margin to trip level by monitoring the output current (d002) and DC voltage (d102).

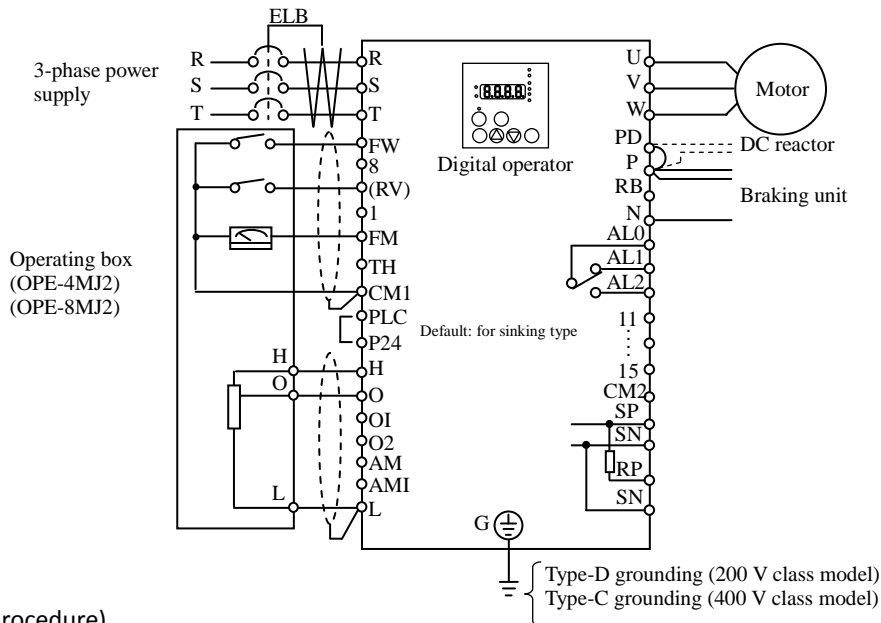

(Operating procedure)

- 1) Confirm that all wirings are correct.
- 2) Turn on the earth-leakage breaker (ELB) to supply power to the inverter.
(The POWER lamp [red LED] of the digital operator goes on.)
- 3) Select the control circuit terminal block as the device to input frequency-setting commands by the frequency source setting function.
 - Display the function code "A001" on the monitor screen, and then press the **(FUNC)** key once.
(The monitor shows a 2-digit numeric value.)
 - Use the **(1)** and/or **(2)** key to change the displayed numeric value to [01], and then press the **(STR)** key once to specify the control circuit terminal block as the device to input frequency-setting commands.
(The display reverts to [A001].)
- 4) Select the control circuit terminal block as the device to input operation commands by the run command source setting function.
 - Display the function code "A002" on the monitor screen, and then press the **(FUNC)** key once.
(The monitor shows a 2-digit numeric value.)
 - Use the **(1)** and/or **(2)** key to change the displayed numeric value to "01", and then press the **(STR)** key once to specify the digital operator as the device to input operation commands.
(The display reverts to [A002].)
- 5) Set the monitor mode.
 - To monitor the output frequency, display the function code "d001", and then press the **(FUNC)** key once.
(The monitor shows the output frequency.)
 - To monitor the operation direction, display the function code "d003", and then press the **(FUNC)** key once.
(The monitor shows **F** for forward operation, **R** for reverse operation, or **0** for stopping.)
- 6) Start the motor operation.
 - Set the FW signal (at the FW terminal on the control terminal block) to the ON level to start the motor.
(The RUN lamp [green LED] goes on.)
 - Apply a voltage across the terminals O and L on the control circuit block to output the frequency corresponding to the applied voltage from the inverter.
- 7) Stop the motor.
 - Set the FW signal (at the FW terminal on the control terminal block) to the OFF level to decelerate and stop the motor.
(When the motor stops, the RUN lamp [green LED] goes off.)

3.4 Example of I/O connections

- Example 1: Frequency command source Setting data in F001 (Digital Operator)
 Run command source RUN/STOP key (Digital Operator)
 *) SJ700D-******FF3** (Initial settings)

(1) I/O connections

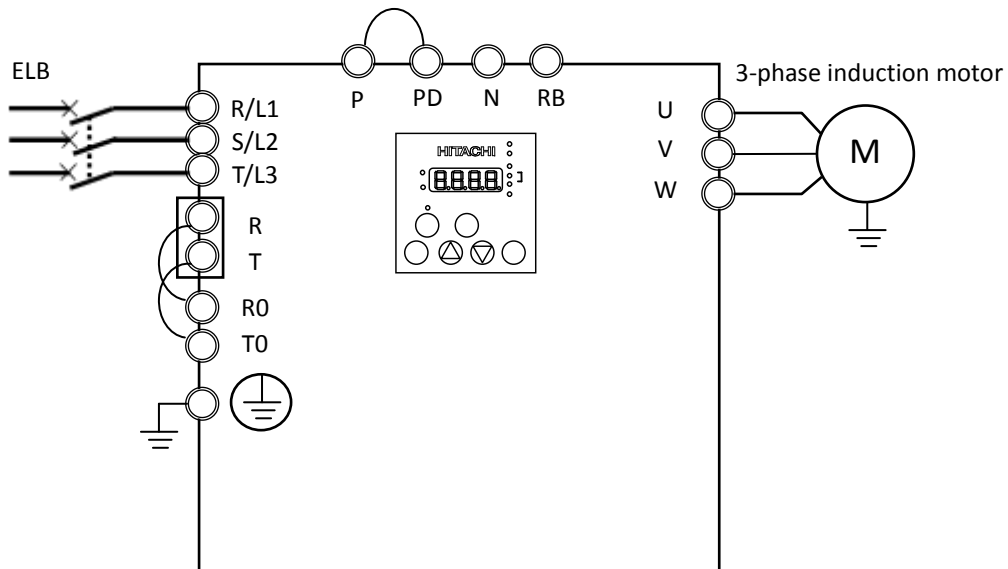

(2) Operation

Frequency: By using the digital operator, set the frequency command into parameter F001.

Run/Stop: Push the key **RUN** and **STOP/RESET** on the digital operator to run and stop.

*) Refer to 3.5.2 for changing the frequency command source and 3.5.3 for changing the run command source.

(3) Parameter settings

Parameter	Details	Setting data
A001	Digital Operator	02
A002	Digital Operator	02
F001	Output frequency setting	0.00 Note)

Note) Initial settings are 0.00Hz. You need to set the appropriate data.

Example 2: : Frequency command source External potentiometer (Control terminal)
 Run command source RUN/STOP key (Control panel)

(1) I/O connections

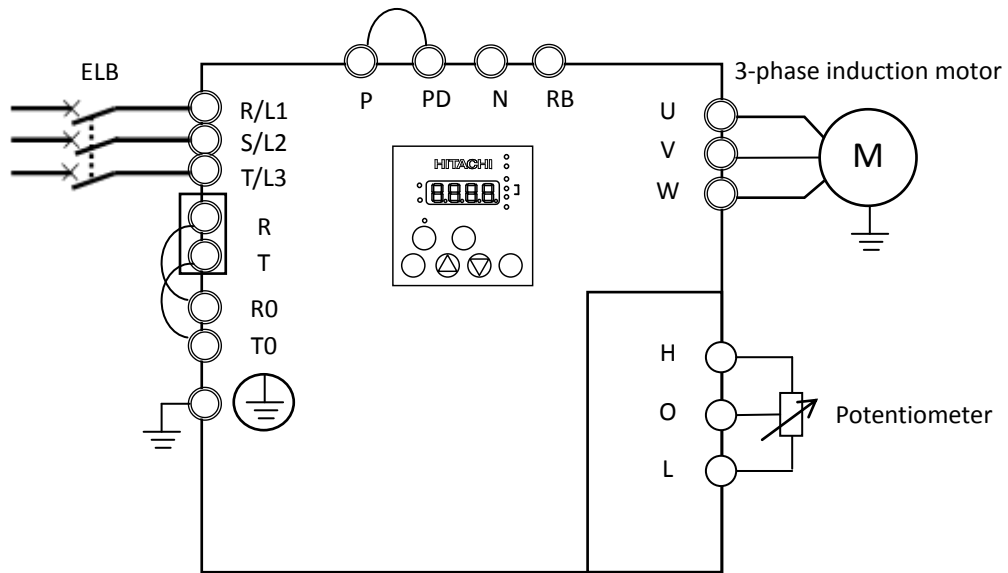

(2) Operation

Frequency: Set the frequency command via a potentiometer connected to H/O/L terminal.

Run/Stop: Push the key **RUN** and **STOP/RESET** to run and stop.

*) Refer to 3.5.2 for changing the frequency command source and 3.5.3 for changing the run command source.

(3) Parameter settings

Parameter	Details	Setting data
A001	Control circuit terminal block	01
A002	Digital Operator	02

Example 3: Frequency command source Setting data in F001 (Control panel) + multi speed select
 Run command source External signal (Control terminal)

(1) I/O connections

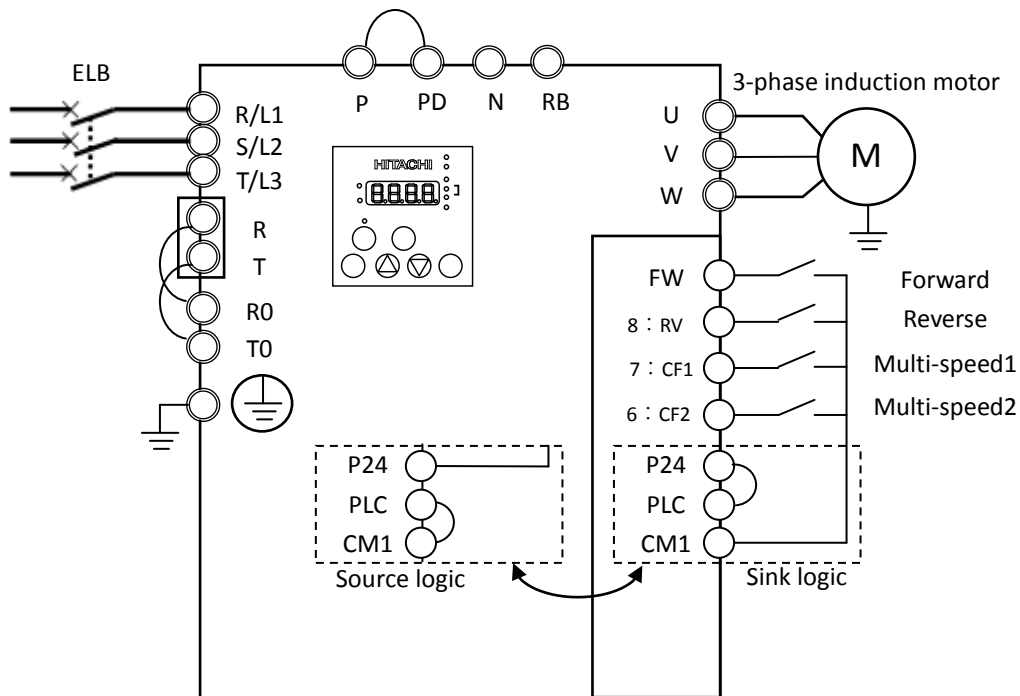

- *) In case of SJ700D-***FUF3, you need to set C006=03 and C016=00.
- *) You need to set multi speed frequency command into parameters (from A020 to A022).
- *) Refer to 3.5.2 for changing the frequency command source and 3.5.3 for changing the run command source.

(2) Operation

Frequency: By using the multi speed terminals, set the frequency command.

Run/Stop: Using the forward / reverse terminal to run and stop.

(3) Parameter settings

Parameter	Details	Setting data
A001	Digital Operator	02
A002	Control circuit terminal block	01
A020	Multi speed 1 and 2 are not active.	0.00 Note)
A021	Multi speed 1 is active and multi speed 2 is not active.	0.00 Note)
A022	Multi speed 1 is not active and multi speed 2 is active.	0.00 Note)

Note) Initial settings are 0.00Hz. You need to set the appropriate data.

Example 4: Frequency command source External analog voltage source and current source (Control terminal)
 Run command source External signal (Control terminal)
 *) SJ700D-****FEF3/FUF3 (Initial settings)

(1) I/O connections

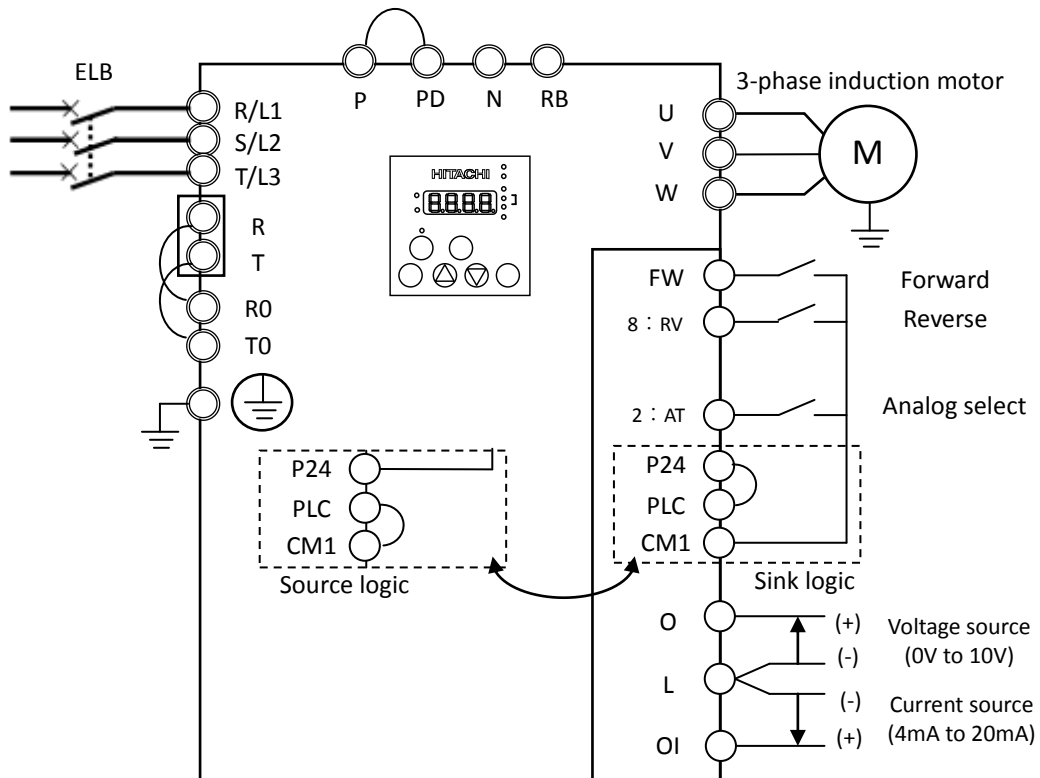

*) Refer to 3.5.2 for changing the frequency command source and 3.5.3 for changing the run command source.

(2) Operation

Frequency: Using the voltage source and current source to set the frequency command with analog select terminal (AT terminal: OFF: Voltage command / ON: Current command).
 * AT terminal is used to switch the analog input O and OI to which the inverter refers as the frequency command. (e.g. When AT terminal is OFF, the inverter outputs the frequency according to the voltage input given to the O terminal)
 Run/Stop: Using the forward / reverse terminal to run and stop.

(3) Parameter settings

Parameter	Details	Setting data
A001	Control circuit terminal block	01
A002	Control circuit terminal block	01

3.5 Basic Parameter Setting to Drive Motor

3.5.1 Setting Frequency command source and Run command source

This section describes how to drive the motor with SJ700D briefly.

The frequency and run command are necessary to drive the motor with the inverter.

In many cases, these sources are set as below;

Setting the frequency : (A) Data settings (Digital operator)
(B) Via external analog signals (Control terminal)

Run and stop : (A) RUN / STOP key (Digital operator)
(B) Via external signal (Control terminal)

The frequency command and Run command sources can be changed by the parameter A001 (Frequency command source) and A002 (Run command source) respectively.

In addition to the basic setting mentioned above, there are several options for A001 and A002 setting.







Parameter	Detail	Data range	Initial settings	
			****FF3	****FEF3 ****FUF3
A001	Frequency source	00(keypad potentiometer) 01(control circuit terminal block) 02(operator) 03(RS485) 04(option 1) 05(option 2) 06(pulse-string input) 07(easy sequence) 10(operation function result)	02	01
A002	Run command source	01(control circuit terminal block) 02(operator) 03(RS485) 04(option 1) 05(option 2)	02	01

*) This chapter explains 01(control circuit terminal block) and 02(operator) mainly.

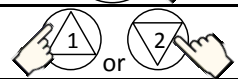
3.5.2 Frequency command source selection

Key operation to set A001

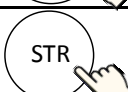
****FF3 : Change A001 from 02 (operator) to 01 (control circuit terminal block).

Procedure	Key operation	Indication	Details
1-1		0.00	After powering up of the inverter, the operator displays 0.00, output frequency monitor (d001)
1-2		d001	Indication changes from data display (0.00) to parameter display (d001).
1-3		A---	Push the key and select the head of Group A.
1-4		A001	Push the key and indication changes from A--- to A001.
1-5		02	Push the key and indication changes to 02(operator).
1-6		01	Push the key and change from 02 to 01 (control circuit terminal block).
1-7		A001	Push the key and indication changes A001 (Data save).
1-8		0.00	By pushing the key for more than three seconds, indication changes to the output frequency data (d001).

****FEF3/FUF3 : Change from 01 (control circuit terminal block) to 02 (operator).



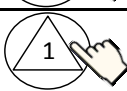

*) Replace the procedure 1-5 and 1-6 in the list above with 1-5' and 1-6' in the list below.

Procedure	Key operation	Indication	Details
1-5'		01	Push the key and indication changes to 01(control circuit terminal block).
1-6'		02	Push the key and change the data to 02 (operator).

Setting frequency command

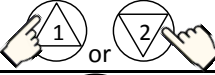
(A) A001=02: Digital operator

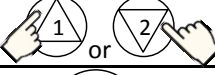
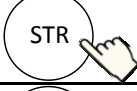
With this setting, the value set in the parameter F001 defines the target frequency of the inverter. The procedure below shows an example of a procedure to set F001=40Hz.

Procedure	Key operation	Indication	Details
1		0.00	After powering up of the inverter, the operator displays 0.00, output frequency monitor (d001)
2		d001	Indication changes from data (0.00) to parameter (d001).
3		F001	Push the key and select F001 (setting frequency).
4		0.00	Push the key and indication changes setting frequency.
5		40.00	(Example) Set the frequency to 40Hz.
6		F001	Push the key and indication goes back to F001 (Data save. note)
7		0.00	By pushing the key for more than three seconds, the indication changes to the output frequency data.

note) In case of the setting A001=02, on displaying the output frequency, the setting frequency can change by the up and down keys.

(B) A001=01: Control terminal

The frequency command can be changed in accordance with the analog input given to the O/OI terminal on the control terminal by using a potentiometer (connected to H/O/L terminal) or an analog voltage / current supply. With this setting, the parameter F001 indicates the frequency command value given via the control terminal. Please refer to the instruction manual for the detailed information about the analog input (e.g. adjustment of the start / end value).

(C) Multi-speed selection – Binary operation

The inverter can store several target frequencies (up to 16), which is useful to define such low / middle / high frequencies and those frequencies are switched by external signals. The actual target frequency is selected from those pre-set frequencies in accordance with the signal status of the multi speed inputs. This part describes an example using 3 frequency sets.

Parameters	Condition	Setting
A001	Operator	02 *1)
A020	Multi speed 1 and 2 are not active.	0.00 *2)
A021	Multi speed 1 is active and multi speed 2 is not active.	0.00 *2)
A022	Multi speed 1 is not active and multi speed 2 is active.	0.00 *2)

*1) In case multi speed 1 and 2 are not active, the setting of A001 defines the frequency command source.







In case of A001=02, and if multi speed 1 and 2 are not active, F001 adopts the A020 value.

*2) Initial settings are 0.00Hz. You should set the appropriate data.

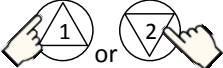
3.5.3 Run command source selection

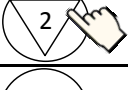

Key operation to set A002

****FF3 : Change from 02 (operator) to 01 (control circuit terminal block).

Procedure	Key operation	Indication	Details
2-1		0.00	After powering up of the inverter, the operator displays 0.00, output frequency monitor (d001)
2-2		d001	Indication changes from data (0.00) to parameter (d001).
2-3		A---	Push the key and select the head of Group A.
2-4		A001	Push the key and indication changes to A001.
2-5		A002	Push the key and select A002 (Run command source).
2-6		02	Push the key and indication changes to 02(operator).
2-7		01	Push the key and change the data to 01 (control circuit terminal block).
2-8		A002	Push the key and indication changes to A002 (Data save).
2-9		0.00	By pushing the key for more than three seconds, indication changes to the output frequency data.

****FEF3/FUF3 : Change 01 (control circuit terminal block) to 02 (operator).

*) Replace the procedure 2-6 and 2-7 on the list above with 2-6' and 2-7' in the list below.

Procedure	Key operation	Indication	Details
2-6'		01	Push the key and indication changes to 01 (control circuit terminal block).
2-7'		02	Push the key and change to 02(operator).

Operating run command

(A) A001=02: Digital operator

RUN and STOP key on the digital operator allows you to start and stop the motor respectively.



*) Changing the rotatory direction can be done by changing the parameter F004, keypad run key routing or to exchange any two phases of the wiring to the motor. Before wiring, you should confirm that the power supply to the inverter has been cut off.

(B) A001=01: Control terminal

You can start and stop the motor operation via the FW terminal (forward rotation) or RV terminal (Reverse rotation).

In case of terminal FW:

Sink logic (short between P24 and PLC)

FW-CM1 short: The inverter runs the motor in the forward direction --- RUN command is active.

FW-CM1 open: The inverter decelerates and stops the motor --- RUN command is not active.

Source logic (short between CM1 and PLC)

FW-P24 short: The inverter runs the motor in the forward direction --- RUN command is active.

FW-P24 open: The inverter decelerates and stops the motor --- RUN command is not active.

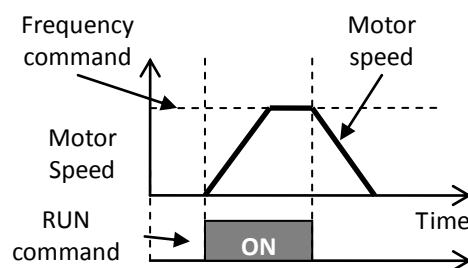

3.6 Dual rating selection

Related code
b049: Dual rating selection

The SJ700D-3 series inverter has Dual Rating, so that it can work in two different types of load condition, Constant torque application and Variable torque application. Select parameter b049 depending on your application.

Name	Function code	Data	Description
Dual rating selection	b049	00	CT : Constant Torque
		01	VT : Variable Torque

- The rating of Constant Torque mode (CT) is same as SJ700-2 series. Overload current characteristic is 150% current / 60 seconds.
- You can use Variable Torque mode (VT), in case the motor works with over rating torque infrequently. When you select VT mode, rated current specification is changed up into VT mode larger than CT mode, you can choose the one size bigger capacity motor than the inverter capacity. Note, overload current characteristic is 120% current / 60 seconds.
- You can set CT mode or VT mode to change b049 without power cutting off.

	Heavy load (CT)	Normal load (VT)
Usage	For heavy load with high torque required at start, acceleration and deceleration.	For normal load without high torque required.
Applications	Elevators, cranes, conveyers, etc.	Fans, pumps, air-conditionings, etc
Rated current (example)	46.0A (3-phase 200V 11.0kW)	44.0A (3-phase 200V 11.0kW)
Overload current	150% 60 sec	120% 60 sec

- When you change to CT mode or VT mode at b049, setting range and an initial value of some parameters change, and some parameters are initialized. You need to set some initialized parameters with setting b049.

- Note that there are difference of setting range and defaults between CT mode and VT mode.
- Note that you change 00 to 01 with the parameter b049, initial data are renewed to below VT mode data.

Name	Function code	Heavy load (CT)		Normal load (VT)	
		Range	default	Range	default
V/F characteristic curve selection, 1st motor	A044	00 (VC), 01 (VP), 02 (free V/f), 03 (sensorless vector control), 04 (0Hz sensorless vector control), 05(vector with sensor)	00 (VC)	00 (VC), 01 (VP), 02 (free V/f), 03 (sensorless vector control),	00 (VC)
V/F characteristic curve selection, 2nd motor	A244	00 (VC), 01 (VP), 02 (free V/f), 03 (sensorless vector control), 04 (0Hz sensorless vector control), 05(vector with sensor)	00 (VC)	00 (VC), 01 (VP), 02 (free V/f), 03 (sensorless vector control),	00 (VC)
DC braking force during deceleration	A054	0. to 100.(%) <0. to 80.(%)>	0(%)	0. to 70.(%) < 0. to 50.(%) >	0(%)
DC braking force for starting	A057	0. to 100.(%) <0. to 80.(%)>	0(%)	0. to 70.(%) <0. to 50.(%)>	0(%)
DC braking carrier frequency setting	A059	0.5 to 15.0(kHz) <0.5 to 10.0(kHz)>	5.0(kHz) <3.0(kHz)>	0.5 to 12.0(kHz) <0.5 to 8.0(kHz)>	3.0(kHz)
Operation mode selection	A085	00 (normal operation), 01 (energy-saving operation) 02 (fuzzy operation)	00 (normal operation)	00 (normal operation), 01 (energy-saving operation)	00 (normal operation)
Overload restriction setting	b022	0.20 to 2.00 x Rated current(A) <0.20 to 1.80 x Rated current(A)>	1.50 x Rated current (A)	0.20 to 1.50 x Rated current(A)	1.20 x Rated current(A)
Overload restriction setting (2)	b025				
Active frequency matching, scan start frequency	b028	0.20 to 2.00 x Rated current(A) <0.20 to 1.80 x Rated current(A)>	Rated current (A)	0.20 to 1.50 x Rated current(A)	Rated current(A)
Torque limit (1) (forward-driving in 4-quadrant mode)	b041	0. to 200.(%)/ __no <0. to 180.(%)/ __no>	150(%)	0. to 150.(%)/ __no	120(%)
Torque limit (2) (reverse-regenerating in 4-quadrant mode)	b042				
Torque limit (3) (reverse-driving in 4-quadrant mode)	b043				
Torque limit (4) (forward-regenerating in 4-quadrant mode)	b044				

Note: < > indicate the setting range of 75 to 150kW

Name	Function code	Heavy load (CT)		Normal load (VT)	
		Range	default	Range	default
Carrier frequency setting	b083	0.5 to 15.0(kHz) <0.5 to 10.0(kHz)>	5.0(kHz) <3.0(kHz)>	0.5 to 12.0(kHz) <0.5 to 8.0(kHz)>	3.0(kHz)
Brake control enable	b120	00 (disabling), 01 (enabling)	00 (disabling)	00 (disabling)	00 (disabling)
Digital current monitor reference value	C030	0.20 x Rated current to 1.50 x Rated current (A) (Current with digital current monitor output at 1,440 Hz)	Rated current (A)	0.00 to 1.50 x Rated current (A)	Rated current (A)
Low-current indication signal detection level	C039	0.00 to 2.00 x rated current(A) <0.00 to 1.80 x Rated current(A)>	Rated current (A)	0.00 to 1.50 x Rated current (A)	Rated current (A)
Overload level setting	C041	0.00 to 2.00 x rated current (A) <0.00 to 1.80 x Rated current(A)>	Rated current (A)	0.00 to 1.50 x Rated current (A)	Rated current (A)
Over-torque (forward-driving) level setting	C055	0. to 200.(%) <0. to 180.(%)>	100(%)	0. to 150.(%)	100(%)
Over-torque (reverse regenerating) level setting	C056				
Over-torque (reverse driving) level setting	C057				
Over-torque (forward regenerating) level setting	C058				
Overload setting (2)	C111	0.00 to 2.00 x rated current <0.00 to 1.80 x Rated current(A)>	Rated current (A)	0.00 to 1.50 x Rated current (A)	Rated current (A)

Note: < > indicate the setting range of 75 to 150kW

(Memo)

Chapter 4 Explanation of Functions

This chapter describes the functions of the inverter.

4.1	Monitor Mode.....	4 - 1
4.2	Function Mode.....	4 - 7
4.3	Functions Available When the Feedback Option Board (SJ-FB) Is Mounted	4 - 96
4.4	Communication Functions	4 - 113

4.1 Monitor Mode

4.1.1 Output frequency monitoring

When the output frequency monitoring function (d001) is selected, the inverter displays the output frequency. The inverter displays "0.00" when the frequency output is stopped.

Related code
d001: Output frequency monitoring

The Hz monitor lamp lights up while the inverter is displaying the output frequency.

(Display)

0.00 to 99.99 in steps of 0.01 Hz
100.0 to 400.0 in steps of 0.1 Hz

Note: When you have selected the digital operator as the device to input frequency-setting commands (A001=02), you can change the output frequency setting by using the Δ or ∇ (only while the inverter is operating the motor).

- The change in output frequency made in this mode can be reflected in the frequency setting (function "F001"). Press the STR key to write the new frequency over the currently selected frequency setting.
- You cannot change the output frequency while the PID function is enabled or the inverter is not operating the motor.

4.1.2 Output current monitoring

When the output current monitoring function (d002) is selected, the inverter displays the output current. The inverter displays "0.0" when the current output is stopped.

Related code
d002: Output current monitoring

The A monitor lamp lights up while the inverter is displaying the output current.

(Display)

0.0 to 999.9 in steps of 0.1 A

4.1.3 Rotation direction monitoring

When the rotation direction monitoring function (d003) is selected, the inverter displays the motor operation direction.

Related code
d003: Rotation direction monitoring

The RUN lamp lights up while the inverter is operating the motor (in forward or reverse direction).

(Display)

F: Forward operation
o: Motor stopped
r: Reverse operation

4.1.4 Process variable (PV), PID feedback monitoring

When "01" (enabling PID operation) or "02" (enabling inverted-data output) has been specified for function "A071" (PID Function Enable) and the process variable (PV), PID feedback monitoring function (d004) is selected, the inverter displays the PID feedback data.

Related code
d004: Process variable (PV),
PID feedback monitoring
A071: PID Function Enable
A075: PV scale conversion

You can also convert the PID feedback to gain data by setting a PV scale conversion (with function "A075").

Value displayed by function "d004" = "feedback quantity" (%) x "PV scale conversion (A075)"

The PV scale conversion can be set (by function "A075") within the range 0.01 to 99.99 in steps of 0.01.

(Display)

0.00 to 99.99 in steps of 0.01
100.0 to 999.9 in steps of 0.1
1000. to 9999. in steps of 1
┌ 100 to ┌ 999 in units of 10

4.1.5 Intelligent input terminal status

When the intelligent input terminal status function (d005) is selected, the inverter displays the states of the inputs to the intelligent input terminals.

The internal CPU of the inverter checks each intelligent input for significance, and the inverter displays active inputs as those in the ON state. (*1)

Intelligent input terminal status is independent of the a/b contact selection for the intelligent input terminals.

(Example)

FW terminal and intelligent input terminals [7], [2], and [1]: ON

Intelligent input terminals [8], [6], [5], [4], and [3]: OFF

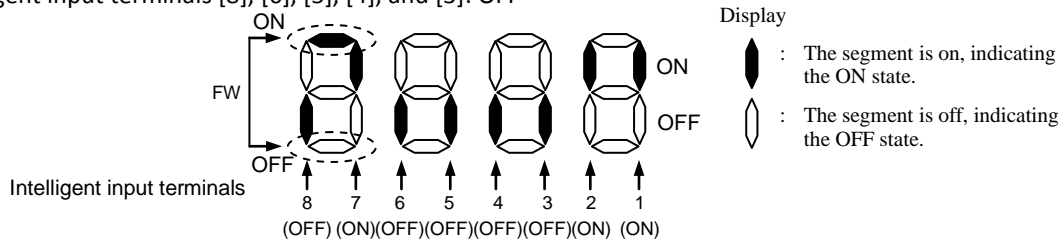

(*1)When input terminal response time is set, terminal recognition is delayed. (refer 4.2.79)

4.1.6 Intelligent output terminal status

When the intelligent output terminal status function (d006) is selected, the inverter displays the states of the outputs from the intelligent output terminals.

This function does not monitor the states of the control circuit terminals but monitors those of the outputs from the internal CPU.

Intelligent input terminal status is independent of the a/b contact selection for the intelligent input terminals.

(Example)

Intelligent output terminals [12] and [11]: ON

Alarm relay terminal AL and intelligent output terminals [15] to [13]: OFF

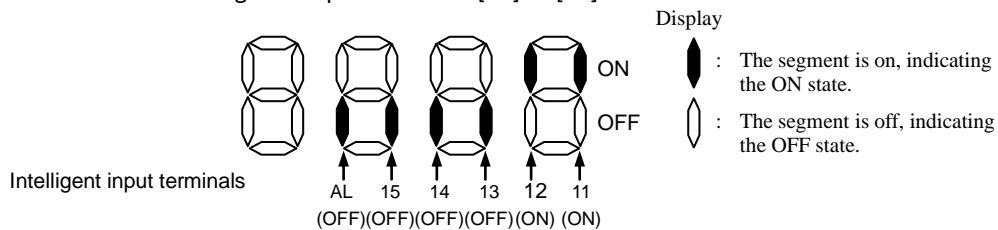

4.1.7 Scaled output frequency monitoring

When the scaled output frequency monitoring (d007) is selected, the inverter displays the gain data converted from the output frequency with the frequency scaling conversion factor (b086).

Use this function, for example, to change the unit of a value (e.g., motor speed) on display.

Value displayed by function "d007" = "output frequency monitor(d001)" x "frequency scaling conversion factor (b086)"

The frequency scaling conversion factor (b086) can be set within the range 0.1 to 99.9 in steps of 0.1.

(Example) Displaying the speed of a 4-pole motor

Speed N (min^{-1}) = $(120 \times f [\text{Hz}])/\text{pole} = f$ (Hz) x 30

As the result of the above calculation with the factor (b086) set to 30.0, the inverter displays "1800" (60 x 30.0) when the output frequency is 60 Hz.

(Display)

0.00 to 99.99 in steps of 0.01

100.0 to 999.9 in steps of 0.1

1000. to 9999. in steps of 1

1000 to 3996 in units of 10

Note: When you have selected the digital operator as the device to input frequency-setting commands, you can change the output frequency setting by using the Δ and/or ∇ key (only while the inverter is operating the motor).

- The change in output frequency made in this mode can be reflected in the frequency setting (function "F001"). Press the STR key to write the new frequency over the currently selected frequency setting. (The precision of the storable frequency data depends on the frequency setting.)
- You cannot change the output frequency while the PID function is enabled or the inverter is not operating the motor.

Related code
d005: Intelligent input terminal status

Related code
d006: Intelligent output terminal status

Related code
d007: Scaled output frequency monitoring
b086: Frequency scaling conversion factor

4.1.8 Actual-frequency monitoring

The actual-frequency monitoring function is effective only when a motor equipped with an encoder is connected to the inverter and the feedback option board (SJ-FB) is mounted in the inverter. When the actual-frequency monitoring function (d008) is selected, the inverter displays the actual operating frequency of the motor (regardless of the motor control method (A044 or A244)).

(Display)

Forward operation:

0.00 to 99.99 in steps of 0.01 Hz-
100.0 to 400.0 in steps of 0.1 Hz

Reverse operation:

0.0 to -99.9 in steps of 0.1 Hz
-100 to -400 in steps of 1 Hz

Note: To use this monitoring function, set the encoder pulse-per-revolution (PPR) setting (P011) and the number of motor poles (H004 or H204) correctly.

Related code

d008: Actual-frequency monitoring
P011: Encoder pulse-per-revolution (PPR) setting
H004: Motor poles setting, 1st motor
H204: Motor poles setting, 2nd motor

4.1.9 Torque command monitoring

The torque command monitoring function is effective when you have selected control by torque for the vector control with sensor. When the torque command monitoring function (d009) is selected, the inverter displays the value of the currently input torque command.

The % monitor lamp lights up while the inverter is displaying the torque command value.

Assign 52 (ATR) on intelligent input terminal and turn on to activate torque control.

(Display)

0. to 200. in steps of 1 %

Related code

d009: Torque command monitoring
P033: Torque command input selection
P034: Torque command setting
A044: V/f characteristic curve selection
C001 to C008: Terminal [1] to [8] functions

4.1.10 Torque bias monitoring

The torque bias monitoring function is effective when you have selected the vector control with sensor. When the torque bias monitoring function (d010) is selected, the inverter displays the value of the currently set value of torque bias. The % monitor lamp lights up while the inverter is displaying the torque bias value.

(Display)

-150. to +150. in steps of 1 %

Related code

d010: Torque bias monitoring
A044: V/f characteristic curve selection
P036: Torque bias mode
P037: Torque bias value
P038: Torque bias polarity

4.1.11 Torque monitoring

When the torque monitoring function (d012) is selected, the inverter displays the estimated value of the torque output from the inverter.

The % monitor lamp lights up while the inverter is displaying the estimated output torque.

(Display)

-300. to +300. in steps of 1 %

Note: This monitoring function is effective only when you have selected the sensorless vector control, 0Hz-range sensorless vector control, or vector control with sensor as the control mode.

Displayed value is not accurate when the other control method is selected.

Related code

d012: Torque monitoring
A044: V/f characteristic curve selection

4.1.12 Output voltage monitoring

When the output voltage monitoring function (d013) is selected, the inverter displays the voltage output from the inverter.

The V monitor lamp lights up while the inverter is displaying the output voltage.

(Display)

0.0 to 600.0 in steps of 0.1 V

(remark) Displayed value may not be accurate when the output voltage is differ from input voltage.

Related code

d013: Output voltage monitoring

4.1.13 Power monitoring

When the power monitoring function (d014) is selected, the inverter displays the electric power (momentary value) input to the inverter.

The kW monitor lamps (V and A lamps) light up while the inverter is displaying the input power.

(Display)

0.0 to 999.9 in steps of 0.1 kW

Related code

d014: Power monitoring

4.1.14 Cumulative power monitoring

When the cumulative power monitoring function is selected, the inverter displays the cumulative value of electric power input to the inverter. You can also convert the value to be displayed to gain data by setting the cumulative input power display gain setting (b079).

Value displayed by function "d015" = "calculated value of input power (kW/h)"/"cumulative input power display gain setting (b079)" The cumulative power input gain can be set within the range 1 to 1000 in steps of 1.

You can clear the cumulative power data by specifying "01" for the cumulative power clearance function (b078) and pressing the STR key.

You can also clear the cumulative power data at an intelligent input terminal by assigning function "53" (KHC: cumulative power clearance) to the intelligent input terminal.

When the cumulative input power display gain setting (b079) is set to "1000", the cumulative power data up to 999000 (kW/h) can be displayed.

(Display)

0.0 to 999.9 in steps of 1 kW/h, or the unit set for function "b079"
 1000 to 9999 in units of 10 kW/h, or the unit set for function "b079"
 100 to 999 in units of 1000 kW/h, or the unit set for function "b079"

Related code

d015: Cumulative power monitoring
 b078: Cumulative power clearance
 b079: Cumulative input power display gain setting

4.1.15 Cumulative operation RUN time monitoring

When the cumulative operation RUN time monitoring function (d016) is elected, the inverter displays the cumulative time of the inverter operation.

(Display)

0. to 9999. in units of 1 hour
 1000 to 9999 in units of 10 hours
 100 to 999 in units of 1,000 hours

Related code

d016: Cumulative operation RUN time monitoring

4.1.16 Cumulative power-on time monitoring

When the cumulative power-on time monitoring function(d017) is selected, the inverter displays the cumulative time throughout which the inverter power has been on.

(Display)

0. to 9999. in units of 1 hour
 1000 to 9999 in units of 10 hours
 100 to 999 in units of 1,000 hours

Related code

d017: Cumulative power-on time monitoring

4.1.17 Heat sink temperature monitoring

When the heat sink temperature monitoring function (d018) is selected, the inverter displays the temperature of the internal heat sink of the inverter.

(Display)

0.0 to 200.0 in steps of 0.1 °C

Related code

d018: Heat sink temperature monitoring

4.1.18 Motor temperature monitoring

When the motor temperature monitoring function is selected, the inverter displays the temperature of the thermistor connected between control circuit terminals TH and CM1. Use the thermistor model PB-41E made by Shibaura Electronics Corporation. Specify "02" (enabling NTC) for the thermistor for thermal protection control (function "b098").

(Display)

0.0 to 200.0 in steps of 0.1 °C.

Note: If "01" (enabling PTC) is specified for the thermistor for thermal protection control (function "b098"), motor temperature monitoring is disabled.

Related code

d019: Motor temperature monitoring
 b098: Thermistor for thermal protection control

4.1.19 Life-check monitoring

When the life-check monitoring function (d002) is selected, the inverter displays the operating life status of two inverter parts output from corresponding intelligent output terminals by using LED segments of the monitor.

The two targets of life-check monitoring are:

- 1: Life of the capacitor on the main circuit board
- 2: Degradation of cooling fan speed

Related code

d022: Life-check monitoring

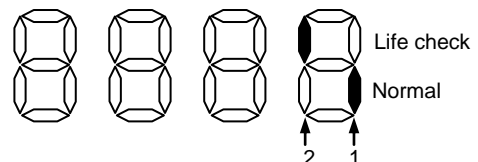

Note 1: The inverter estimates the capacitor life every 10 minutes. If you turn the inverter power on and off repeatedly at intervals of less than 10 minutes, the capacitor life cannot be checked correctly.

Note 2: If you have specified "01" for the selection of cooling fan operation (function "b0092"), the inverter determines the cooling fan speed to be normal while the cooling fan is stopped.

4.1.20 Program counter display (easy sequence function)

While the easy sequence function is operating, the inverter displays the program line number that is being executed.

For details, refer to the "Programming Software EzSQ" manual.

Related code
d023: Program counter

4.1.21 Program number monitoring (easy sequence function)

When the program number monitoring function (d024) is selected, the inverter displays the program number of the downloaded easy sequence program.

Note that you must describe a program number in the program you create. For details, refer to the "Programming Software EzSQ" manual.

Related code
d024: Program number monitoring

4.1.22 User Monitors 0 to 2 (easy sequence function)

The user monitor function allows you to monitor the results of operations in an easy sequence program.

For details, refer to the Programming Software EzSQ Instruction Manual.

Related code
d025: user monitor 0
d026: user monitor 1
d027: user monitor 2

4.1.23 Pulse counter monitor

Pulse counter monitor allows you to monitor the accumulated pulse of intelligent input terminals pulse counter 74 (PCNT).

Related code
d028: Pulse counter monitor

4.1.24 Position command monitor (in absolute position control mode)

The user monitor function allows you to monitor the results of operations in an easy sequence program.

For details, refer to the Programming Software EzSQ Instruction Manual.

Related code
d029: Pulse counter monitor

4.1.25 Current position monitor (in absolute position control mode)

The current position monitor function allows you to monitor the current position in absolute position control mode.

For details, see Section 4.3.12.

Related code
d030: Position feedback monitor

4.1.26 Inverter mode

Selected mode is displayed.

(Display)

i - [: Constant torque mode with induction motor

i - u : Variable torque mode with induction motor

Related code
d060: Inverter mode monitor

4.1.27 Trip Counter

When the trip counter function (d080) is selected, the inverter displays the number of times the inverter has tripped.

(Display)

0. to 9999. in units of 1 trip

1000 to 6553 in units of 10 trips

Related code
d080: Trip Counter

4.1.28 Trip monitoring 1 to 6

When the trip monitoring function (d081 to d086) is selected, the inverter displays the trip history data. The last six protective trips the inverter made can be displayed.

Select the trip monitoring 1 (d081) to display the data on the most recent trip.

(Display contents)

- 1) Factor of tripping (one of E01 to E79) (*1)
- 2) Output frequency at tripping (Hz)
- 3) Output current at tripping (A) (*2)
- 4) Main circuit DC voltage at tripping (V) (*3)
- 5) Cumulative inverter-running time until tripping (h)
- 6) Cumulative inverter power-on time until tripping (h)

*1 See Section 5.1.1, "Protective functions."

*2 When the inverter status is in stop mode as a trip history, monitored value can be zero.

*3 When grounding fault is detected at power on, monitored value can be zero.

Related code

d081: Trip monitoring 1
d082: Trip monitoring 2
d083: Trip monitoring 3
d084: Trip monitoring 4
d085: Trip monitoring 5
d086: Trip monitoring 6

(Display by trip monitoring)

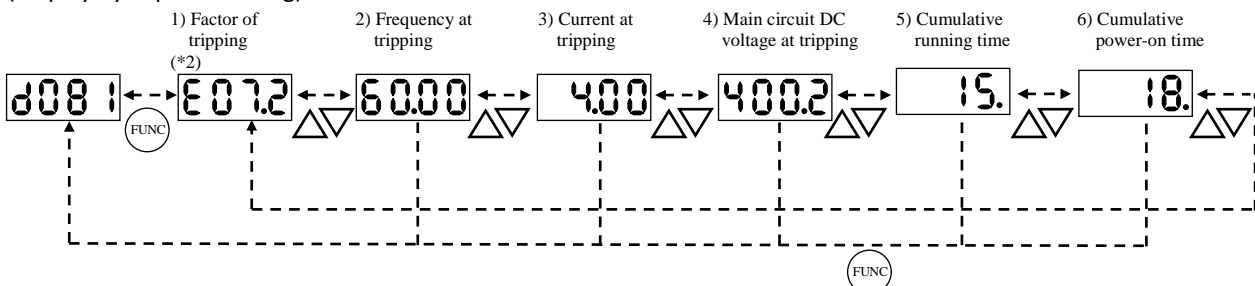

*2 If the inverter has not tripped before, the inverter displays



4.1.29 Programming error monitoring

If an attempt is made to set the data conflicting with other data on the inverter, the inverter displays a warning.

The PRG (program) lamp lights up while the warning is displayed (until the data is rewritten forcibly or corrected).

For details on the programming error monitoring function, see Section 5.2. Warning Codes

Related code

d090: Programming error monitoring

4.1.30 DC voltage monitoring

When the DC voltage monitoring is selected, the inverter displays the DC voltage (across terminals P and N) of the inverter.

While the inverter is operating, the monitored value changes as the actual DC voltage of the inverter changes.

(Display)

0.0 to 999.9 in steps of 0.1 V

Related code

d102: DC voltage monitoring

4.1.31 BRD load factor monitoring

When the BRD load factor monitoring function (d103) is selected, the inverter displays the BRD load factor. If the BRD load factor exceeds the value set as the dynamic braking usage ratio (b090), the inverter will trip because of the braking resistor overload protection (error code "E06").

(Display)

0.0 to 100.0 in steps of 0.1%

Related code

d103: BRD load factor monitoring
b090: Dynamic braking usage ratio

4.1.32 Electronic thermal overload monitoring

When the electronic thermal overload monitoring function (d104) is selected, the inverter displays the electronic thermal overload. If the electronic thermal overload exceeds 100%, the inverter will trip because of the overload protection (error code "E05").

(Display)

0.0 to 100.0 in steps of 0.1%

Related code

d104: Electronic thermal overload monitoring

4.2 Function Mode

4.2.1 Output frequency setting

The output frequency setting function allows you to set the inverter output frequency.

You can set the inverter output frequency with this function (F001) only when you have specified "02" for the frequency source setting (A001). For other methods of frequency setting, see Section 4.2.4, "frequency source setting (A001)."

(If the setting of function "A001" is other than "02", function "F001" operates as the frequency command monitoring function.)

The frequency set with function "F001" is automatically set as the Multispeed frequency setting (A020). To set the second and third multispeeds, use the multispeed frequency setting, 2nd motor, function (A220) and multispeed frequency setting, 3rd motor, function (A320), or use function "F001" for the setting after turning on the SET and SET3 signals. For the setting using the SET and SET3 signals, assign the SET function (08) and SET3 function (17) to intelligent input terminals.

If the set output frequency is used as the target data for the PID function, PID feedback data will be displayed in percent (%). ("100%" indicates the maximum frequency.)

Related code

F001: Output frequency setting
 A001: Frequency source setting
 A020/A220/A320:
 Multispeed frequency setting,
 1st/2nd/3rd motors
 C001 to C008:
 Terminal [1] to [8] functions

Item	Function code	Range of data	Description
Output frequency setting	F001	0.0, start frequency to maximum frequency, 1st/2nd/3rd motors (Hz)	The frequency set with F001 is equal to the setting of A020.
Multispeed 0	A020/A220/A320		The second control frequency set with F001 is equal to the setting of A220. The third control frequency set with F001 is equal to the setting of A320.

4.2.2 Keypad Run key routing

When you enter operation commands via the digital operator, the Keypad Run key routing function allows you to select the direction of motor operation.

This function is ineffective when you use the control terminal block or remote operator to input operation commands.

Related code

F004: Keypad Run key routing

Item	Function code	Data	Description
Keypad Run key routing	F004	00	Forward operation
		01	Reverse operation

4.2.3 Rotational direction restriction

The rotational direction restriction function allows you to restrict the direction of motor operation.

This function is effective regardless of the specification of operation command input device (e.g., control circuit block or digital operator).

If an operation command to drive the motor in a restricted direction is input, the inverter (digital operator) will display .

Related code

b035: Rotational direction restriction

Item	Function code	Data	Description
Rotational direction restriction	b035	00	Both forward and reverse operations are enabled.
		01	Only forward operation is enabled.
		02	Only reverse operation is enabled.

4.2.4 Frequency source setting

The frequency source setting function allows you to select the method to input the frequency-setting command.

Related code
A001: Frequency source setting

Motor rotation direction is inverted when -10 to 0V is given as frequency command to O2-L terminals.

Item	Function code	Data	Description
Frequency source setting	A001	(00)	(Valid only when the OPE-SR is used) Use the control provided on the digital operator to set the frequency.
		01	Input the frequency-setting command via a control circuit terminal (O-L, OI-L, or O2-L).
		02	Use the digital operator (function "F001") or remote operator to set the frequency.
		03	Input the frequency-setting command via an RS485 communication terminal.
		04	Input the frequency-setting command from the board connected to optional port 1.
		05	Input the frequency-setting command from the board connected to optional port 2.
		06	Use the SJ-FB to input the frequency-setting command as a pulse train (see 4.2.21)
		07	Use the SET-Freq command of the easy sequence function as the frequency-setting command.
		10	Use the operation result of the set frequency operation function as the frequency-setting command. (see 4.2.12)

4.2.5 Run command source setting

The run command source setting function allows you to select the method to input operation commands (to start and stop the motor). As the operation commands via control circuit terminals, turn the FW signal (for forward operation) or RV signal (for reverse operation) on and off to start and stop the motor, respectively.

(Note that the factory setting assigns the FW signal to intelligent input terminal [8].)

To switch each intelligent input terminal between a and b contacts, specify each terminal with function "C011" to "C019", and then perform input a/b (NO/NC) selection for each terminal.

When using the digital operation for the inverter operation, specify the desired motor operation direction with function "F004", and use the RUN and STOP/RESET keys to start and stop the motor, respectively.

If the start commands for both forward and reverse operations are input at the same time, the inverter will assume the input of a stop command.

Related code
A002: Run command source setting
C001 to C008: Terminal [1] to [8] functions
C019: Terminal [FW] active state
F004: Keypad Run key routing

Item	Function code	Data	Description
Run command source setting	A002	01	Input the start and stop commands via control circuit terminals (FW and RV).
		02	Input the start and stop commands from the digital or remote operator.
		03	Input the start and stop commands via RS485 communication terminals.
		04	Input the start and stop commands from option board 1.
		05	Input the start and stop commands from option board 2.
Terminal [FW] active state	C019 C011 to C018	00	a (NO) contact
		01	b (NC) contact

Note 1: If function "31" (forcible operation) or "51" (forcible-operation terminal) is assigned to an intelligent input terminal, the settings made with functions "A001" and "A002" will be invalidated when the said intelligent input terminal is turned on and those methods to input frequency-setting and operation commands which are specified for the said terminal will be enabled.

Note 2: On the remote operator (SRW) being used to operate the inverter, pressing the REMT (remote) key enables you to input both frequency-setting and operation commands from the remote operator.

Note 3: When the DeviceNet option board (SJ-DN) is used, A002 is not needed to be changed from default because the run command source is automatically set via DeviceNet. (In case it is changed, it is to be set as 01, 02 or 03.)

4.2.6 Stop mode selection

The stop mode selection function allows you to select one of two methods of stopping the motor when a stop command is input from the digital operator or via the control circuit terminal block. One is to decelerate the motor according to the specified deceleration time and then stop it; the other is to let the motor run freely until it stops.

If a start command is input while the motor is in free-running status, the inverter will restart the motor according to the setting of the restart mode after FRS (b088). (See Section 4.2.47.)

Related code

b091: Stop mode selection
 F003/F203/F303:
 Deceleration (1) time setting,
 1st/2nd/3rd motors
 b003: Retry wait time before motor restart
 b007: Restart frequency threshold
 b008: Restart mode after FRS

Item	Function code	Data	Description
Stop mode selection	b091	00	Normal stopping (stopping after deceleration)
		01	Free-running until stopping
Restart mode after FRS	b088	00	Starting with 0 Hz
		01	Starting with matching frequency
Restart frequency threshold	b007	0.00 to 400.0(Hz)	Starting with 0 Hz if the frequency-matching result is less than the set lower limit
Retry wait time before motor restart	b003	0.3 to 100.(s)	Time to wait until the restart of the motor after free-running ends

4.2.7 STOP key enable

When the control circuit terminal block is selected as the device to input operation commands, the STOP key enable function allows you to enable or disable the motor-stopping and trip reset functions of the STOP key of the digital operator.

This function is effective only when the digital operator (02) is not specified for the run command source setting (A002) (see Section 4.2.5).

If the digital operator (02) is specified for "A002", the motor-stopping and trip reset functions of the STOP key are enabled regardless of this setting (STOP key enable).

Related code

b087: STOP key enable

Function code	Data	Stop command with STOP key	Trip reset command with STOP key
b087	00	Enabled	Enabled
	01	Disabled	Disabled
	02	Disabled	Enabled

4.2.8 Acceleration/deceleration time setting

- Specify a longer time for slower acceleration or deceleration; specify a shorter time for quicker acceleration or deceleration.
- The time set with this function is the time to accelerate (or decelerate) the motor from 0 Hz to the maximum frequency (or vice versa).
- If you assign the acceleration/deceleration cancellation (LAC) function to an intelligent input terminal and turns on the terminal, the set acceleration/deceleration time will be ignored, and the output frequency will immediately follow the frequency-setting command.
- To switch the acceleration and deceleration time among the 1st, 2nd, and 3rd settings, assign function "08" (SET) and "17" (SET3) to intelligent input terminals (see Section 4.2.38). Use the SET and SET3 signals for switching.
- As the Accel/decel time input selection by P031, select one of the (1) input from the digital operation, (2) input from option board 1, (3) input from option board 2, and (4) input from the easy sequence program.

Related code

F002/F202/F302: Acceleration (1) time setting, 1st/2nd/3rd motors
 F003/F203/F303: Deceleration (1) time setting, 1st/2nd/3rd motors
 A004/A204/A304: Maximum frequency setting, 1st/2nd/3rd motors
 P031: Accel/decel time input selection
 C001 to C008: Terminal [1] to [8] functions

Item	Function code	Range of data	Description
Acceleration (1) time setting	F002/F202/F302	0.01 to 3600.(s)	Set the length of time to accelerate the motor from 0 Hz to the maximum frequency.
Deceleration (1) time setting	F003/F203/F303	0.01 to 3600.(s)	Set the length of time to decelerate the motor from the maximum frequency to 0 Hz.
Accel/decel time input selection	P031	00	Input from the digital operator (OPE)
		01	Input from option board 1 (OP1)
		02	Input from option board 1 (OP2)
		03	Input from the easy sequence program (PRG)
Terminal function	C001 to C008	46	LAD cancellation

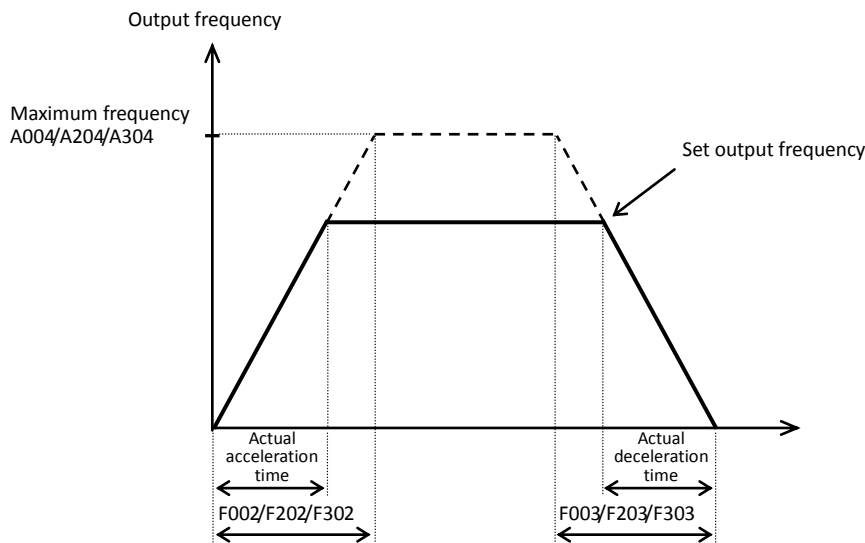

The actual time to accelerate/decelerate the motor will be no less than the minimum acceleration/deceleration time that depends on the inertial effect (J) due to the mechanical system and motor torque. If you set a time shorter than the minimum acceleration/deceleration time, the inverter may trip because of overcurrent or overvoltage.

Acceleration time (ts)

$$t_s = \frac{(J_L + J_M) \times N_M}{9.55 \times (T_s - T_L)}$$

- J_L: Inertia effect (J) of the load converted to that of the motor shaft (kg·m²)
- J_M: Inertia effect (J) of the motor (kg·m²)
- N_M: Motor speed (rpm)

Deceleration time (t_B)

$$t_B = \frac{(J_L + J_M) \times N_M}{9.55 \times (T_B + T_L)}$$

- T_s: Maximum acceleration torque driven by the inverter (N·m)
- T_B: Maximum deceleration torque driven by the inverter (N·m)
- T_L: Required running torque (N·m)

4.2.9 Base frequency setting

(1) Base frequency and motor voltage

- With the base frequency setting and AVR voltage select functions, adjust the inverter outputs (frequency and voltage) to the motor ratings.

- The base frequency is the nominal frequency of the motor. Set a frequency that meets the motor specification. Carefully note that setting the base frequency to less than 50 Hz may result in motor burnout.

- A special motor requires a base frequency of 60 Hz or more. inverter model may not be suitable for such a special motor, and with a larger capacity may be required.

- Select the motor voltage that meets the motor specification.

Selecting a motor voltage exceeding the motor specification may in motor burnout.

- To switch the base frequency among the 1st, 2nd, and 3rd settings, assign function "08" (SET) and "17" (SET3) to intelligent input terminals (see Section 4.2.38). Use the SET and SET3 signals for switching.

Related code
 A003/A203/A303: Base frequency setting, 1st/2nd/3rd motors
 A081: AVR function select
 A082: AVR voltage select

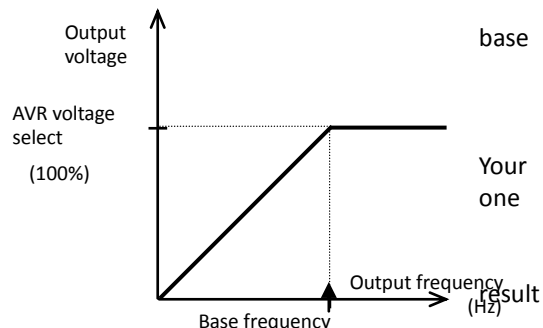

Item	Function code	Range of data	Description
Base frequency setting	A003/A203/A303	30. to maximum frequency, 1st/2nd/3rd motors (Hz)	
AVR voltage select	A082	200/215/220/230/240	Selectable on 200 V class inverter models
		380/400/415/440/460/480	Selectable on 400 V class inverter models

(2) AVR function

The AVR function maintains the correct voltage output to the motor, even when the voltage input to the inverter fluctuates. The output voltage maintained by this function is based on the voltage specified by the AVR voltage select. Use the AVR function select (A081) to enable or disable the AVR function.

Item	Function code	Data	Description
AVR function select	A081	00	The AVR function is always enabled.
		01	The AVR function is always disabled.
		02	The AVR function is disabled at deceleration. (*1)

*1 Disabling the AVR function at motor deceleration increases the energy loss on the decelerated motor and decreases the energy regenerated on the inverter, which results in a shorter deceleration time.

4.2.10 Maximum frequency setting

The maximum frequency setting function allows you to set the maximum frequency of the motor driven by the inverter.

The maximum frequency set here corresponds to the maximum level of each external analog input (See Section 4.2.12) (for example, 10 V of the input of 0 to 10 V).

To switch the maximum frequency among the 1st, 2nd, and 3rd settings, assign function "08" (SET) and "17" (SET3) to intelligent input terminals. Use the SET and SET3 signals for switching.

The inverter output voltage with the frequency ranging from the base frequency to the maximum frequency is that selected by the AVR voltage select function (A082).

Related code
 A004/A204/A304: Maximum frequency setting, 1st/2nd/3rd motors

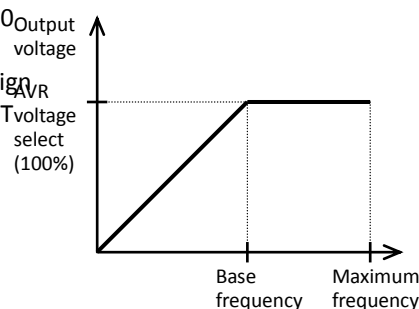

Item	Function code	Range of data	Description
Maximum frequency setting	A004/A204/A304	30. to 400. (Hz)	The maximum output frequency is set.

4.2.11 External analog input setting (O, OI, and O2)

The inverter has the following three types of external analog input terminals:

O-L terminal: 0 to 10 V

OI-L terminal: 4 to 20 mA

O2-L terminal: -10 to 10 V

Related code
 A005: [AT] selection
 A006: [O2] selection
 C001 to C008: Terminal [1] to [8] functions

The table below lists the settings of the external analog input terminals.

Item	Function code	Data	Description
[AT] selection	A005	00	Switching between the O and OI terminals with the AT terminal Turning on the AT terminal enables the OI-L terminal. Turning on the AT terminal enables the O-L terminal.
		01	Switching between the O and O2 terminals with the AT terminal Turning on the AT terminal enables the O2-L terminal. Turning on the AT terminal enables the O-L terminal.
		(02)	(Valid only when the OPE-SR is used) Switching between the O terminal and the control with the AT terminal Turning on the AT terminal enables the pot on OPE-SR terminal. Turning on the AT terminal enables the O-L terminal.
		(03)	(Valid only when the OPE-SR is used) Switching between the OI terminal and the control with the AT terminal Turning on the AT terminal enables the pot on OPE-SR terminal. Turning on the AT terminal enables the OI-L terminal.
		(04)	(Valid only when the OPE-SR is used) Switching between the O2 terminal and the control with the AT terminal Turning on the AT terminal enables the pot on OPE-SR terminal. Turning on the AT terminal enables the O2-L terminal.
[O2] selection	A006	00	Using the O2 terminal independently
		01	Using the O2 terminal for auxiliary frequency command (nonreversible) in addition to the O and OI terminals
		02	Using the O2 terminal for auxiliary frequency command (reversible) in addition to the O and OI terminals
		03	Disabling the O2 terminal

Note that whether frequency commands are input to the O2-L terminal and whether the motor operation is reversible depend on the combination of settings of functions "A005" and "A006" and whether function "16" (AT) is assigned to an intelligent input terminal as shown in the table below.

When the motor operation is reversible, the inverter operates the motor in a reverse direction if the sum of the frequencies specified by the main frequency and auxiliary frequency commands is less than 0 (even when the forward operation [FW] terminal is on). Even when no wire is connected to the O2 terminal, reverse operation of the motor may occur and prolong the acceleration time if the output voltage fluctuates near 0 V.

	A006	A005	AT terminal	Main frequency command	Whether to input an auxiliary frequency command (via the O2-L terminal)	Reversible/nonreversible	
When the AT function is assigned to an intelligent input terminal	00,03	00	OFF	O-L terminal	No input	Nonreversible	
			ON	OI-L terminal	No input		
		01	OFF	O-L terminal	No input		
			ON	O2-L terminal	No input		Reversible
	01	(Example 1)	00	OFF	O-L terminal	Input	Nonreversible
			ON	OI-L terminal	Input		
			01	OFF	O-L terminal	Input	
				ON	O2-L terminal	No input	
	02	(Example 2)	00	OFF	O-L terminal	Input	Reversible
			ON	OI-L terminal	Input		
			01	OFF	O-L terminal	Input	
				ON	O2-L terminal	No input	
When the AT function is not assigned to any intelligent input terminal	00	—	—	O2-L terminal	No input	Reversible	
	01	—	—	Addition of signals on O-L and OI-L terminals	Input	Nonreversible	
	02	—	—	Addition of signals on O-L and OI-L terminals	Input	Reversible	
	03	—	—	Addition of signals on O-L and OI-L terminals	No input	Nonreversible	

(Example 1) When the motor operation is not reversible

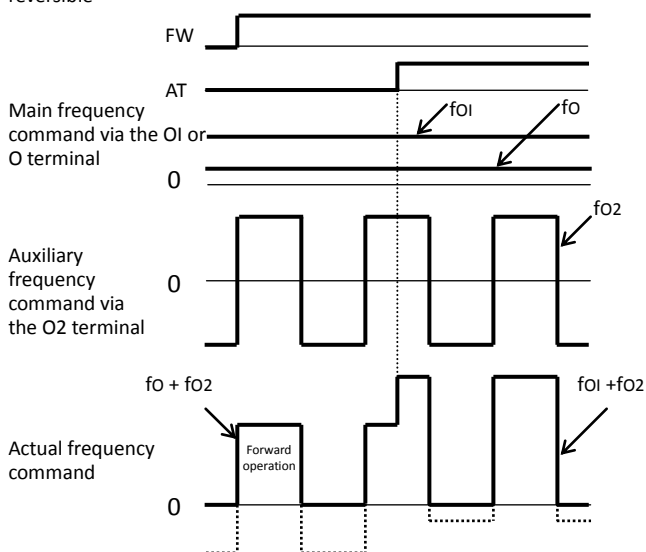

(Example 1) When the motor operation is reversible

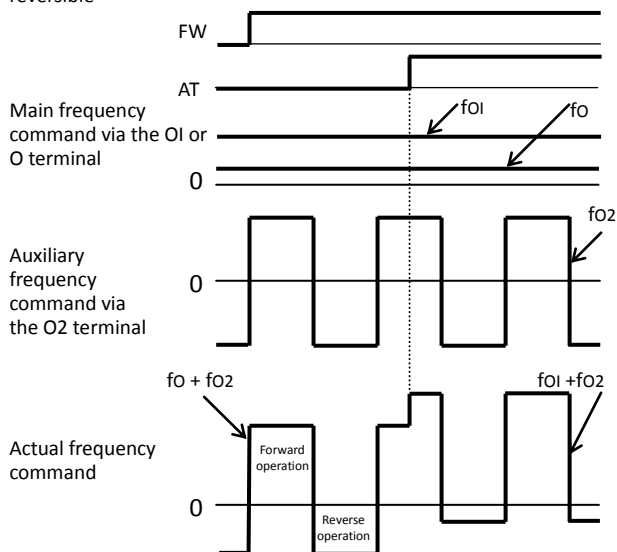

4.2.12 Frequency operation function

The frequency operation function allows you to use the result of an arithmetic operation on two frequency commands as the actual frequency command or PID feedback data.

To use the operation result as the actual frequency command, specify "10" for the frequency source setting (A001).

To use the operation result as the PID feedback data, specify "10" for the PV source setting (A076).

- Related code
- A141: Operation-target frequency selection 1
 - A142: Operation-target frequency selection 2
 - A143: Operator selection
 - A001: Frequency source setting
 - A076: PV source setting

Item	Function code	Data	Description
Operation-target frequency selection 1 and 2	A141/A142	00	Digital operator (A020/A220/A320)
		(01)	Control on the digital operator (Valid only when the OPE-SR is connected)
		02	Input via the O terminal
		03	Input via the OI terminal
		04	Input via the RS485 terminal
		05	Input from option board 1
		06	Input from option board 2
		07	Input of pulse train
Operator selection for frequency operation	A143	00	Addition: (A141) + (A142)
		01	Subtraction: (A141) - (A142)
		02	Multiplication: (A141) x (A142)
Frequency source setting	A001	10	Output of operation result
PV source setting	A076	10	Output of operation result

Note 1: The [1] (up) and [2] (down) keys of the digital operator are ineffective when the frequency operation function is enabled. Also, the frequency displayed by the output frequency monitoring (d001), Scaled output frequency monitoring (d007), or output frequency setting (F001) cannot be changed with key operations.

Note 2: The settings of "A141" and "A142" can be the same.

4.2.13 Frequency addition function

The frequency addition function allows you to add or subtract the value specified as the frequency to be added (A145) to or from the frequency value of a selected frequency command.

To use this function, assign function "50" (ADD) to an intelligent input terminal.

When the ADD terminal is turned on, the inverter performs the addition or subtraction of the value specified as "A145".

Related code

A145: Frequency to be added
A146: Sign of the frequency to be added
C001 to C008: Terminal [1] to [8] functions

Item	Function code	Data or range of data	Description
Frequency to be added	A145	0.00 to 400.00(Hz)	Setting of the frequency to be added
Selection of the sign of the frequency to be added	A146	00	(Frequency command) + (A145)
		01	(Frequency command) - (A145)
Terminal function	C001 to C008	50	ADD selection of the trigger for adding the frequency (A145)

Note 1: If the sign of the frequency value in the frequency command changes from minus (-) to plus (+), or vice versa, as the result of frequency addition, the motor operation direction will be inverted.

Note 2: When the PID function is used, the frequency addition function can apply to PID target data. (In such cases, the data display by function "A145" is in percentage [in steps of 0.01%]).

4.2.14 Start/end frequency setting for external analog input

The start/end frequency setting function allows you to set the inverter output frequency in relation to the external analog inputs (frequency commands) via the following terminals:

O-L terminal: 0 to 10 V

OI-L terminal: 4 to 20 mA

O2-L terminal: -10 to +10 V

Related code

A011: [O]-[L] input active range start frequency
A012: [O]-[L] input active range end frequency
A013: [O]-[L] input active range start voltage
A014: [O]-[L] input active range end voltage
A015: [O]-[L] input start frequency enable
A101: [OI]-[L] input active range start frequency
A102: [OI]-[L] input active range end frequency
A103: [OI]-[L] input active range start current
A104: [OI]-[L] input active range end current
A105: [OI]-[L] input start frequency enable
A111: [O2]-[L] input active range start frequency
A112: [O2]-[L] input active range end frequency
A113: [O2]-[L] input active range start voltage
A114: [O2]-[L] input active range end voltage

(1) Start/end frequency settings for the O-L and OI-L terminals

Item	Function code	Range of data	Description
[O]/[OI]-[L] input active range start frequency	A011/A101	0.00 to 400.0(Hz)	Setting of the start frequency
[O]/[OI]-[L] input active range end frequency	A012/A102	0.00 to 400.0(Hz)	Setting of the end frequency
[O]/[OI]-[L] input active range start voltage	A013/A103	0. to 100.(%)	Setting of the rate of the start frequency to the external frequency command (0 to 10 V/0 to 20 mA)
[O]/[OI]-[L] input active range end voltage	A014/A104	0. to 100.(%)	Setting of the rate of the end frequency to the external frequency command (0 to 10 V/0 to 20 mA)
[O]/[OI]-[L] input start frequency enable	A015/A105	00	Externally input start frequency The frequency set as "A011" or "A101" is output as the output frequency while the start-frequency rate is 0% to the value set as "A013" or "A103".
		01	0 Hz 0 Hz is output as the output frequency while the start-frequency rate is 0% to the value set as "A013" or "A103".

If the voltage of the signal to be input to the O-L terminal is 0 to 5 V, specify 50% for "A014".

(Example 1) A015/A105: 00

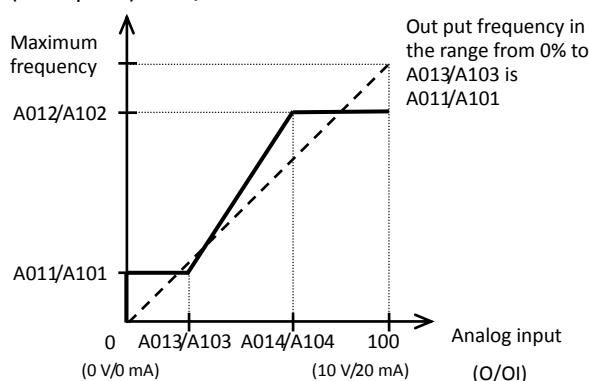

(Example 2) A015/A105: 01

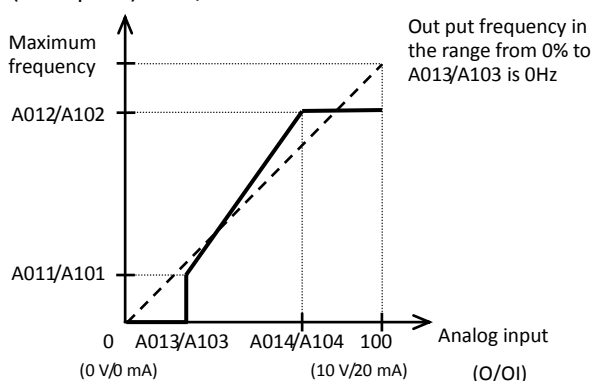

(2) Start/end frequency settings for the O2-L terminal

Item	Function code	Range of data	Description	Remarks
O2 start frequency	A111	-400. to 400.(Hz)	Setting of the start frequency	(Example 3)
O2 end frequency	A112	-400. to 400.(Hz)	Setting of the end frequency	
O2 start-frequency rate	A113	-100. to 100.(%)	Setting of the rate of the start frequency to the external frequency command (-10 to +10 V) (*1)	
O2 end-frequency rate	A114	-100. to 100.(%)	Setting of the rate of the end frequency to the external frequency command (-10 to +10 V) (*1)	

*1 The frequency rates correspond to the voltages (-10 to +10 V) of the external frequency command as follows:
 -10 to 0 V: -100% to 0%
 0 to +10 V: 0% to 100%

For example, if the voltage of the signal to be input to the O2-L terminal is -5 to +5 V, specify 50% for "A114".

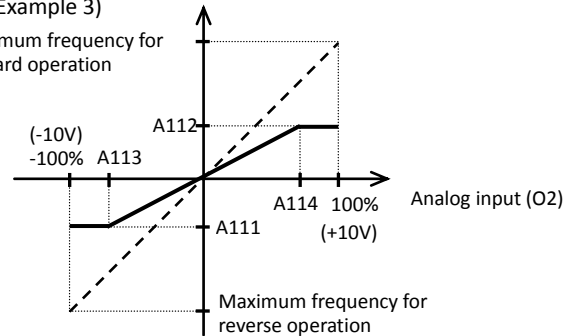

4.2.15 External analog input (O/OI/O2) filter setting

The external analog input filter setting function allows you to set the input-voltage/input-current sampling time to be applied when frequency commands are input as external analog signals.

You can use this filter function effectively for removing noise from the frequency-setting circuit signal.

If the noise disables the stable operation of the inverter, increase the setting. Setting a larger value makes the inverter response slower. The filtering constant is "set value (1 to 30) x 2 ms."

When the setting is "31" (factory setting), a hysteresis of ±0.1 Hz is added to the filtering constant (500 ms).

Related code
 A016: External frequency filter time const.

Item	Function code	Range of data	Description
External frequency filter time const.	A016	1. to 30. or 31.	Setting of 1. to 30.: "Set value x 2" ms filter Setting of 31.: 500 ms filter (fixed) with hysteresis of ±0.1 Hz

4.2.16 V/f gain setting

The V/f gain setting function allows you to change the inverter output voltage by specifying the rate of the output voltage to the voltage (100%) selected with the AVR voltage select function (A082).

If the motor operation is cranky, try to increase the gain setting.

Related code
 A045: V/f gain setting
 A082: AVR voltage select

Item	Function code	Range of data	Description
V/f gain setting	A045	20. to 100. (%)	Setting of the rate of reducing the output voltage

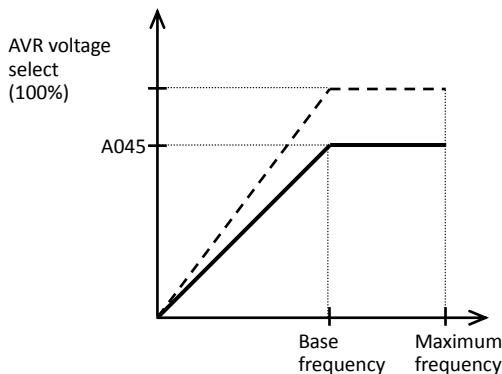

4.2.17 V/F characteristic curve selection

The V/F characteristic curve selection function allows you to set the output voltage/output frequency (V/f) characteristic.

To switch the V/F characteristic curve selection among the 1st, 2nd, and 3rd settings, assign function "08" (SET) and "17" (SET3) to intelligent input terminals. Use the SET and SET3 signals for switching.

Related code

A044/A244/A344: V/F characteristic curve selection, 1st/2nd/3rd motors
 b100/b102/b104/b106/b108/b110/b112: Free-setting V/f frequency (1) (2) (3) (4) (5) (6) (7)
 b101/b103/b105/b107/b109/b111/b113: Free-setting V/f voltage (1) (2) (3) (4) (5) (6) (7)

Function code	Data	V/f characteristic	Remarks
A044/A244/ A344	00	Constant torque characteristic (VC)	
	01	Reduced-torque characteristic (1.7th power of VP)	
	02	Free V/f characteristic	Available only for A044 and A244
	03	Sensorless vector control (SLV)	Available only for A044 and A244 (See Section 4.2.96.)
	04	0 Hz-range sensorless vector control	Available only for A044 and A244 (See Section 4.2.97.)
	05	Vector control with sensor (V2)	Available only for A044

(1) Constant torque characteristic (VC)

With this control system set, the output voltage is in proportion to the output frequency within the range from 0 Hz to the base frequency. Within the output frequency range over the base frequency up to the maximum frequency, the output voltage is constant, regardless of the change in the output frequency.

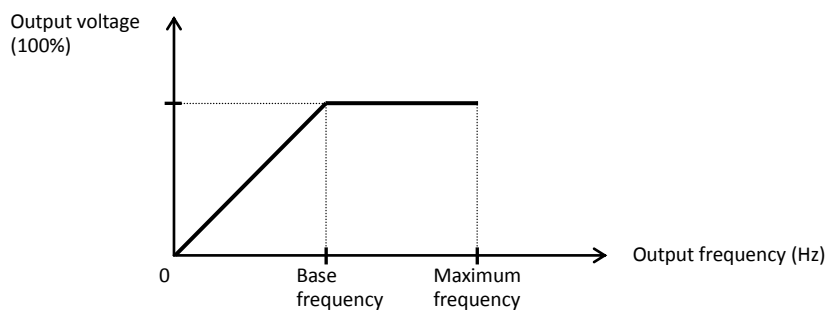

(2) Reduced-torque characteristic (1.7th power of VP)

This control system is suited when the inverter is used with equipment (e.g., fan or pump) that does not require a large torque at a low speed.

Since this control system reduces the output voltage at low frequencies, you can use it to increase the efficiency of equipment operation and reduce the noise and vibrations generated from the equipment.

The V/f characteristic curve for this control system is shown below.

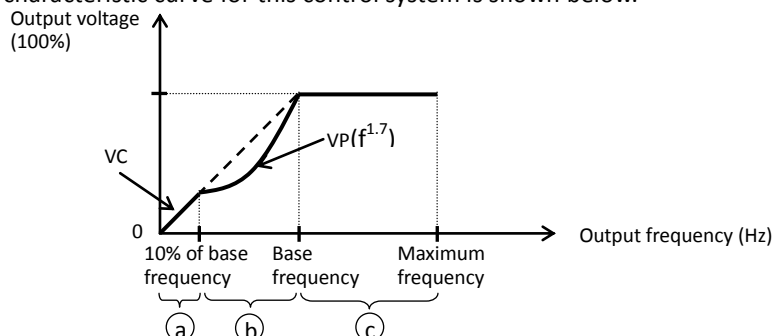

Period (a): While the output frequency increases from 0 Hz to the 10% of the base frequency, the output voltage follows the constant torque characteristic.

(Example) If the base frequency is 60 Hz, the constant torque characteristic is maintained within the output frequency range of 0 to 60 Hz.

Period (b): While the output frequency increases from the 10% of base frequency to the base frequency, the output voltage follows the reduced-torque characteristic. In other words, the output voltage increases according to the 1.7th power of the output frequency.

Period (c): While the output frequency increases from the base frequency to the maximum frequency, the output voltage is constant.

(3) Free V/f characteristic setting

The free V/f characteristic setting function allows you to set an arbitrary V/f characteristic by specifying the voltages and frequencies (b100 to b113) for the seven points on the V/f characteristic curve.

The free V/f frequencies (1 to 7) set by this function must always be in the collating sequence of "1 ≤ 2 ≤ 3 ≤ 4 ≤ 5 ≤ 6 ≤ 7".

Since all free V/f frequencies are set to 0 Hz as default (factory setting), specify their arbitrary values (begin setting with free-setting V/f frequency (7)). (The inverter cannot operate with the free V/f characteristic in the factory setting.)

Enabling the free V/f characteristic setting function disables the torque boost selection (A041/A241), base frequency setting (A003/A203/A303), and maximum frequency setting (A004/A204/A304).

(The inverter assumes the value of free-setting V/f frequency (7) as the maximum frequency.)

Item	Function code	Data	Description
Free-setting V/f frequency (7)	b112	0 to 400.(Hz)	Setting of the output frequency at each breakpoint of the V/f characteristic curve
Free-setting V/f frequency (6)	b110	0. to free-setting V/f frequency (7) (Hz)	
Free-setting V/f frequency (5)	b108	0. to free-setting V/f frequency (6) (Hz)	
Free-setting V/f frequency (4)	b106	0. to free-setting V/f frequency (5) (Hz)	
Free-setting V/f frequency (3)	b104	0. to free-setting V/f frequency (4) (Hz)	
Free-setting V/f frequency (2)	b102	0. to free-setting V/f frequency (3) (Hz)	
Free-setting V/f frequency (1)	b100	0. to free-setting V/f frequency (2) (Hz)	
Free-setting V/f voltage (7)	b113	0.0 to 800.0(V)	Setting of the output voltage at each breakpoint of the V/f characteristic curve (*1)
Free-setting V/f voltage (6)	b111		
Free-setting V/f voltage (5)	b109		
Free-setting V/f voltage (4)	b107		
Free-setting V/f voltage (3)	b105		
Free-setting V/f voltage (2)	b103		
Free-setting V/f voltage (1)	b101		

(Example)

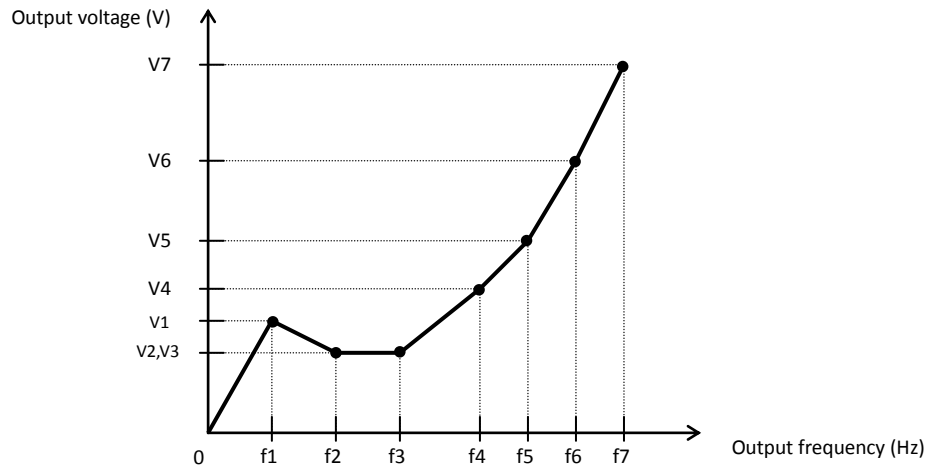

*1 Even if 800 V is set as a free-setting V/f voltage (1 to 7), the inverter output voltage cannot exceed the inverter input voltage or that specified by the AVR voltage select. Carefully note that selecting an inappropriate control system (V/f characteristic) may result in overcurrent during motor acceleration or deceleration or vibration of the motor or other machine driven by the inverter.

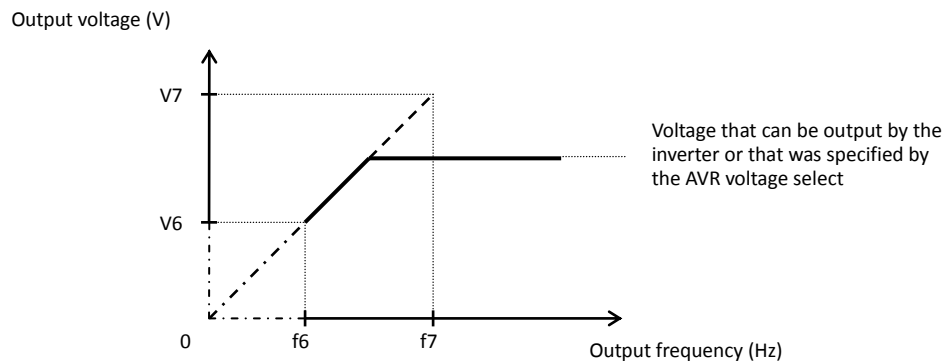

4.2.18 Torque boost setting

The torque boost setting function allows you to compensate for the voltage drop due to wiring and the primary resistance of the motor so as to improve the motor torque at low speeds.

When you select automatic torque boost by the torque boost selection (A041/A241), adjust the settings of the motor capacity selection (H003/H203) and motor pole selection (H004/H204) based on the motor to be driven.

Related code

A041/A241: Torque boost selection, 1st/2nd motors
 A042/A242/A342: Manual torque boost value, 1st/2nd/3rd motors
 A043/A243/A343: Manual torque boost frequency adjustment, 1st/2nd/3rd motors
 H003/H203: Motor capacity, 1st/2nd motors
 H004/H204: Motor poles setting, 1st/2nd motors

Item	Function code	Data or range of data	Description
Torque boost selection	A041/A241	00	Manual torque boost
		01	Automatic torque boost
Manual torque boost value	A042/A242/A342	0.0 to 20.0(%)	Setting of the rate of the boost to the output voltage (100%)
Manual torque boost frequency adjustment	A043/A243/A343	0.0 to 50.0(%)	Setting of the rate of the frequency at breakpoint to the base frequency
Motor capacity	H003/H203	0.20 to 75.0(kW)	Selection of the motor capacity
Motor poles setting	H004/H204	2, 4, 6, 8, or 10 (poles)	Selection of the number of poles of the motor
Voltage compensation gain setting for automatic torque boost	A046/A246	0. to 255.	See Item (2), "Automatic torque boost."
Slippage compensation gain setting for automatic torque boost	A047/A247	0. to 255.	See Item (2), "Automatic torque boost."

(1) Automatic torque boost

The inverter outputs the voltage according to the settings of the manual torque boost (A042/A242/A342) and manual torque boost frequency adjustment (A043/A243/A343).

Use the manual torque boost value (A042/A242/A342) to specify the rate of the boost to the voltage (100%) set by the AVR voltage select.

The set rate of voltage corresponds to the boost voltage that is output when the output frequency is 0 Hz.

When increasing the value of the manual torque boost value, be careful to prevent motor over-excitation.

Over-excitation may result in motor burnout.

Use the manual torque boost frequency adjustment (A043/A243/A343) to specify the rate of the frequency at each breakpoint to the base frequency (100%).

To switch the settings among the 1st, 2nd, and 3rd settings ("A041 to A043", "A241 to A243", and "A342 and A343"), assign function "08" (SET) and "17" (SET3) to intelligent input terminals. Use the SET and SET3 signals for switching.

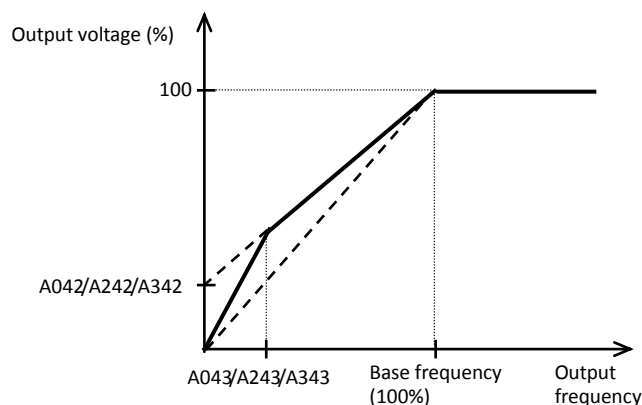

(2) Automatic torque boost

When automatic torque boost (data "01") is selected by the torque boost selection (A041/A241), the inverter automatically adjusts the output frequency and voltage according to the load on the motor.

(During actual operation, the automatic torque boost is usually combined with the manual torque boost.)

When you select the automatic torque boost, adjust the settings of the motor capacity selection (H003/H203) and motor pole selection (H004/H204) according to the motor to be driven.

If the inverter trips due to overcurrent during motor deceleration, set the AVR function select (A081) to always enable the AVR function (data "00").

If you cannot obtain the desired operation characteristic by using the automatic torque boost, make the following adjustments:

Symptom	Adjustment method	Adjustment item
Motor torque is insufficient at low speed. (The motor does not rotate at low speed.)	(1) Increase the voltage setting for manual torque boost step by step.	A042/A242
	(2) Increase the slippage compensation gain for automatic torque boost step by step.	A047/A247
	(3) Increase the voltage compensation gain for automatic torque boost step by step.	A046/A246
	(4) Reduce the carrier frequency setting.	b083
The motor speed falls when a load is applied to the motor.	Increase the slippage compensation gain for the automatic torque boost step by step.	A047/A247
The motor speed increases when a load is applied to the motor.	Reduce the slippage compensation gain for the automatic torque boost step by step.	A047/A247
The inverter trips due to overcurrent when a load is applied to the motor.	(1) Reduce the voltage compensation gain for the automatic torque boost step by step.	A046/A246
	(2) Reduce the slippage compensation gain for the automatic torque boost step by step.	A047/A247
	(3) Reduce the voltage setting for the manual torque boost step by step.	A042/A242

This function cannot be selection for 3rd moter setting.

Manual torque boost valid.

4.2.19 DC braking (DB) setting

The DC braking function allows you to apply DC braking to the motor according to the load on the motor.

You can control DC braking in two ways: the external control through signal input to intelligent input terminals and the internal control to be performed automatically when the motor is started and stopped.

Note that the motor cannot be stopped by DC braking if the load on the motor produces a large moment of inertia.

- Related code
- A051: DC braking enable
 - A052: DC braking frequency setting
 - A053: DC braking wait time
 - A054: DC braking force during deceleration
 - A055: DC braking time for deceleration
 - A056: DC braking/edge or level detection for [DB] input
 - A057: DC braking force for starting
 - A058: DC braking time for starting
 - A059: DC braking carrier frequency setting
 - C001 to C008: Terminal [1] to [8] functions

Item	Function code	Data or range of data	Description
DC braking enable	A051	00	Internal DC braking is disabled.
		01	Internal DC braking is enabled.
		02	Internal DC braking is enabled. (The braking operates only with the set braking frequency.)
DC braking frequency setting	A052	0.00 to 60.00 (Hz)	With internal DC braking enabled, DC braking is started when the output frequency reaches the set braking frequency.
DC braking wait time	A053	0.0 to 5.0 (s)	The DC braking wait time specifies the delay in starting DC braking after the set braking time has elapsed or the DB terminal has been turned on.
DC braking force during deceleration/ DC braking force for starting	A054/ A057	CT mode : 0. to 100. (%)<0. to 80.(%)> VT mode : 0. to 70. (%)<0. to 50.(%)>	"0" specifies the smallest force (zero current); "100" specifies the largest force (rated current).
DC braking time for deceleration	A055	0.0 to 60.0 (s)	This setting is valid for the external DC braking in edge mode or for the internal DC braking.
DC braking/edge or level detection for [DB] input	A056	00	Edge mode (See examples 1-a to 6-a.)
		01	Level mode (See examples 1-b to 6-b.)
DC braking time for starting	A058	0.0 to 60.0 (s)	This setting is valid for the internal DC braking. DC braking is started when the motor-start command is input.
DC braking carrier frequency setting	A059	CT mode : 0.5 to 15.0 (kHz)<0.5 to 10.0(kHz)> VT mode : 0.5 to 12.0 (kHz)<0.5 to 8.0(kHz)>	Unit: kHz

(NOTE) <>:applied for 75 to 150kW

(1) Carrier frequency for DC braking

Use the DC braking carrier frequency setting (A059) to specify the carrier frequency for DC braking. But the raking power reduced is reduced when 5Hz (up to 55kW) or 3Hz (75-150kW) are set as shown below. For detailed decreasing ratio, "DC braking limiter" is to be referred.

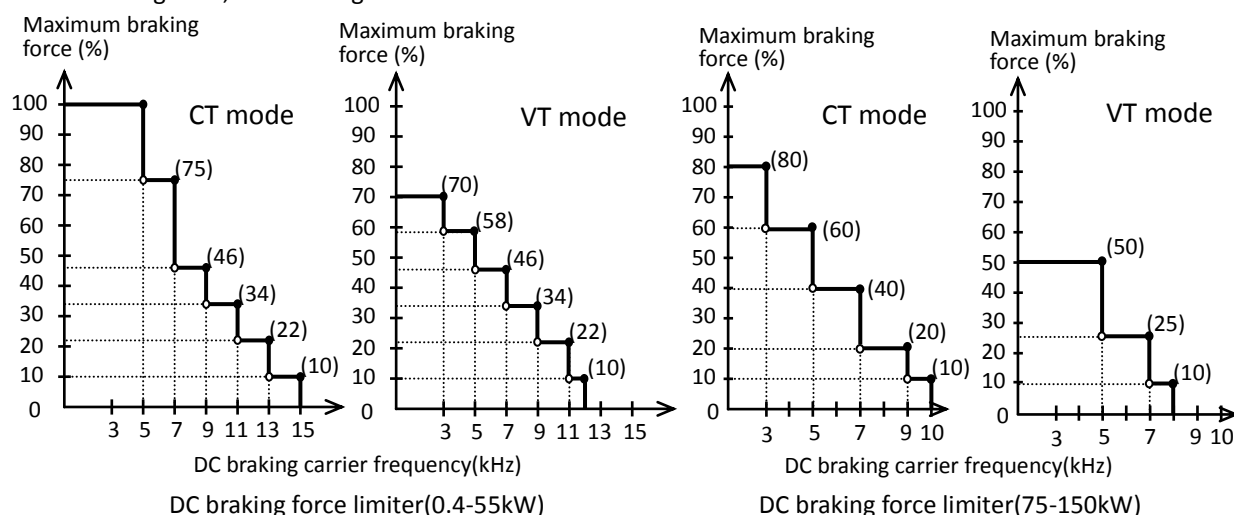

(2) External DC braking

Assign function "07" (DB) to terminal function (C001 to C008).

Turn the DB terminal on and off to control the direct braking, regardless of the setting of DC braking enable (A051).

Adjust the braking force by adjusting the DC braking force setting (A054).

When you set the DC braking wait time (A053), the inverter output will be shut off for the set period of delay, and the motor will run freely during the period. DC braking will be restarted after the delay.

When setting the DC braking time with function "A055" or for the DC braking operation via the DB terminal, determine the length of time in consideration of the heat generation on the motor.

Select the braking mode by the DC braking/edge or level detection for [DB] input (A056), and then make any other necessary settings suitable for your system.

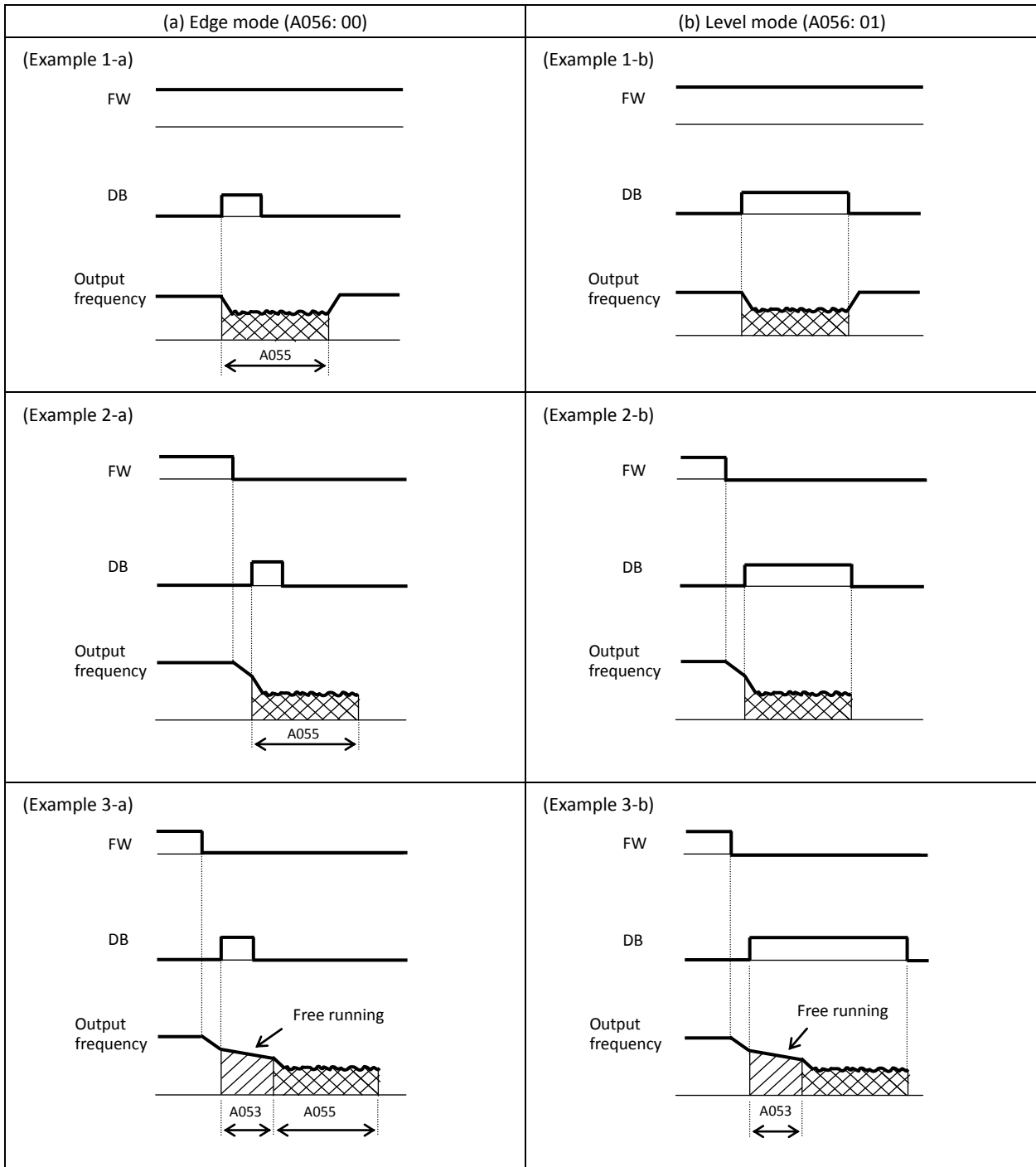

(3) Internal DC braking (A051: 01)

You can apply DC braking to the motor even without entering braking signals via the DB terminal when the inverter starts and stops. To use the internal DC braking function, specify "01" for the DC braking enable (A051).

Use function "A057" to set the DC braking force for starting, and use function "A058" to specify the DC braking time for starting, regardless of the braking mode selection (edge or level mode). (See examples 4-a and 4-b.)

Set the braking force for periods other than starting by using the DC braking force setting (A054).

Set the output frequency at which to start DC braking by using the DC braking frequency setting (A052).

When you set the DC braking wait time (A053), the inverter output will be shut off when the output frequency reaches the setting of "A052" after the operation command (FW signal) is turned off, and the motor will run freely for the delay time set by "A053". DC braking will be started after the delay (A053).

The internal DC braking operation to be performed when the operation command is switched from the stop command to the start command varies depending on the braking mode (edge or level mode).

Edge mode: The DC braking time setting (A055) is given priority over operation commands, and the inverter performs DC braking according to the setting of "A055". When the output frequency reaches the setting of "A052" the inverter performs DC braking for the time set for "A055". Even if the stop command is input during DC braking, DC braking continues until the time set for "A055" elapses. (See examples 5-a and 6-a.)

Level mode: Operation commands are given priority over the DC braking time setting. The inverter follows operation commands, regardless of the DC braking time setting (A055). If the start command is input during DC braking, the inverter starts the normal motor operation, regardless of the DC braking time setting (A055). (See examples 5-b and 6-b.)

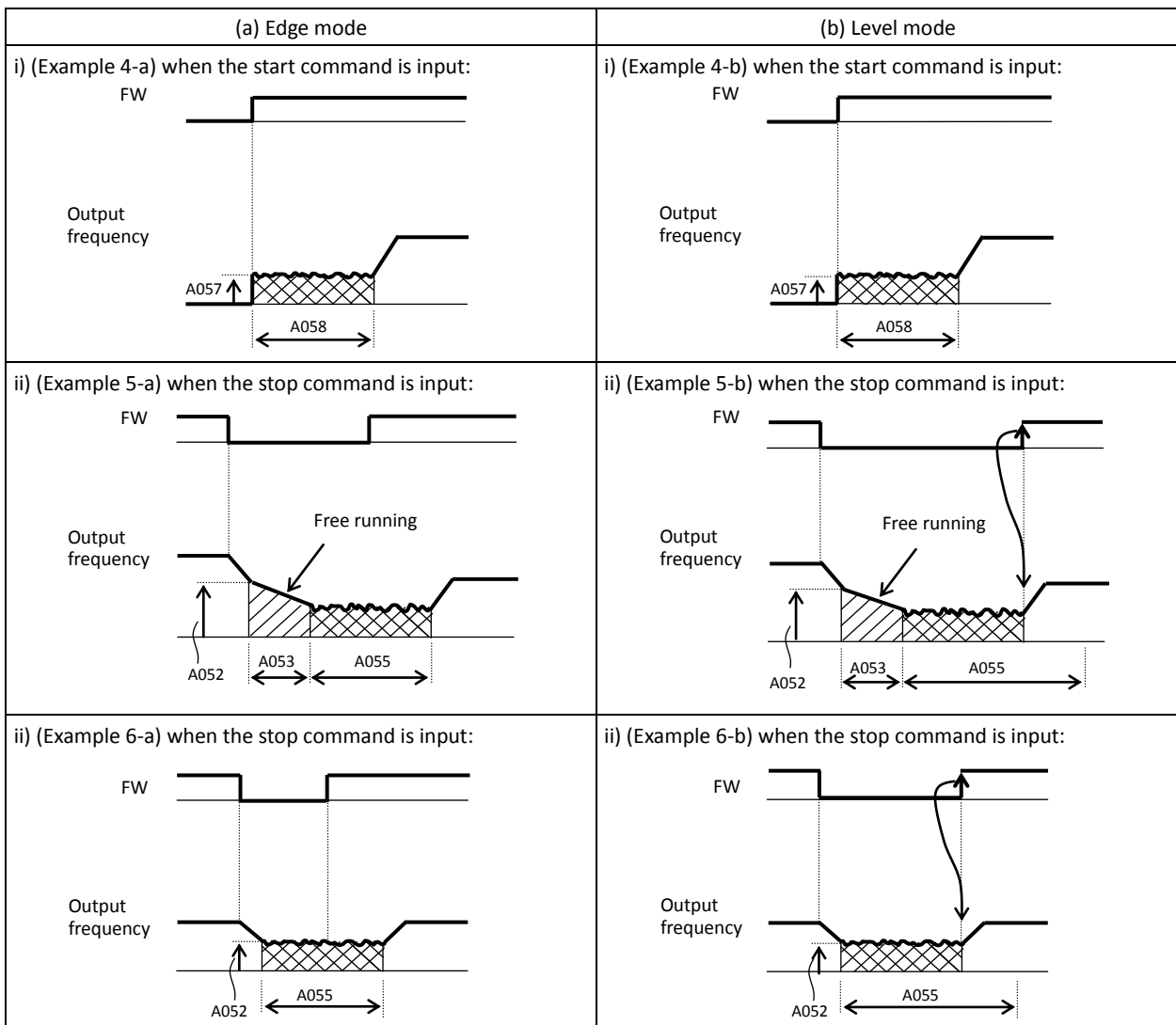

(4) Internal DC braking (triggered only when the output frequency reaches a set frequency) (A051: 02)

You can also operate the internal DC braking function so that DC braking is applied to the motor when the inverter output frequency falls to the DC braking frequency setting (A052) or below.

When the internal DC braking function is used in this mode, the external DC braking described in Item (2) and the internal DC braking described in Item (3) cannot be used.

In this mode, DC braking operates only when the operation command signal is on (i.e., the start command is input).

The inverter starts DC braking when both the frequency set by the frequency command and the current output frequency fall to the DC braking frequency setting (A052) or below. (See example 7-a.)

When the frequency set by the frequency command increases to the "setting of 'A052' + 2 Hz" or more, the inverter stops DC braking and restores its normal output. (See example 7-a.)

If the frequency set by the frequency command is 0 Hz when the start command is input via an analog input terminal, the inverter will start operation with DC braking because both the frequency set by the frequency command and current output frequency are 0 Hz. (See example 7-b.)

If the operation command signal (start command) is turned on when the frequency command specifies a frequency larger than the DC braking frequency (A052), the inverter will start operation with the normal output.

(Example 7-a)

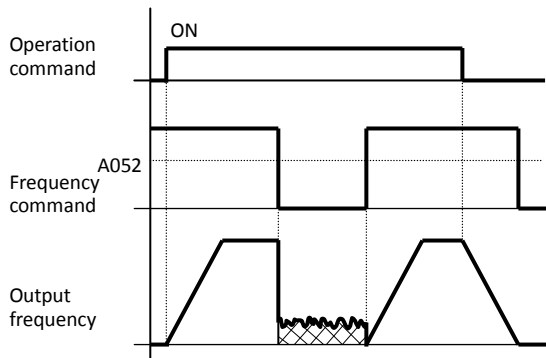

(Example 7-b)

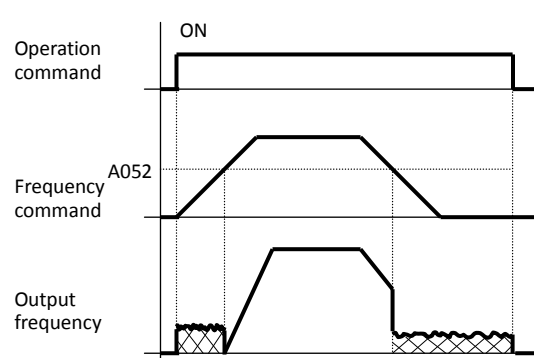

How the inverter returns to the normal output varies depending on the setting of the DC braking/edge or level detection for [DB] input (A054).

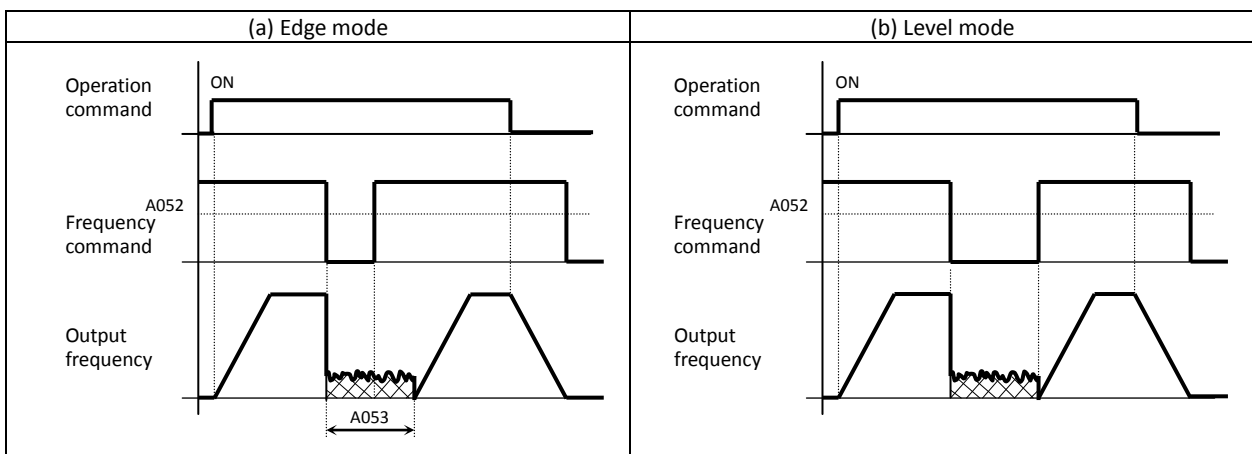

4.2.20 Frequency upper limit setting

The frequency upper limit setting function allows you to place upper and lower limits on the inverter output frequency.

This function restricts the input of frequency commands that specify any frequencies outside the upper and lower limits.

Always set the upper limit before setting the lower limit. Also, be sure to keep the frequency upper limit (A061/A261) larger than the frequency lower limit (A062/A262).

Be sure that upper limit/lower limit does not exceed Maximum frequency (A004/A204/A304).

Be sure to set output frequency (F001) and multiple speed 1 to 15 (A021 to A035) in between upper limit and lower limit.

If 0 Hz is set for the frequency upper and lower limits, they will not operate.

The frequency limit setting function is disabled when the 3rd control system is selected.

Related code

A061/A261: /Frequency upper limit setting, 1st/2nd motors
 A062/A262: Frequency lower limit setting, 1st/2nd motors

Item	Function code	Range of data	Description
Frequency upper limit setting	A061/A261	0.00 or a frequency more than the frequency lower limit setting up to the maximum frequency (Hz)	Setting of the upper limit of the output frequency
Frequency lower limit setting	A062/A262	0.00 or a frequency not less than the starting frequency up to the frequency upper limit setting (Hz)	Setting of the lower limit of the output frequency

(1) When the O-L or OI-L terminal is used:

Output frequency (Hz)

Maximum frequency
A004/A204

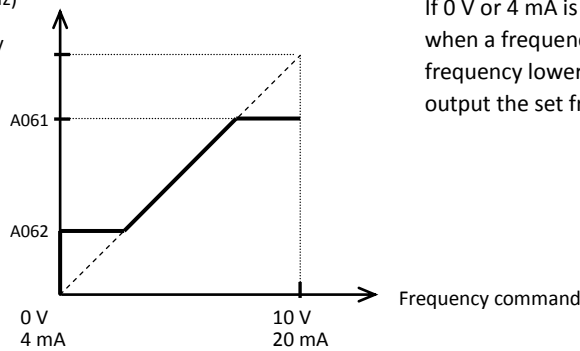

If 0 V or 4 mA is input as the frequency command when a frequency lower limit has been set for the frequency lower limit setting (A062), the inverter will output the set frequency.

(2) When the O2-L terminal is used:

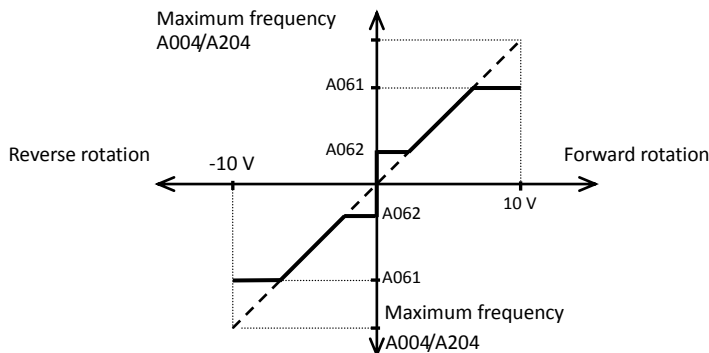

If the frequency lower limit is used with the frequency command input via the O2-L terminal, the motor speed with 0 V input will be fixed to the frequency setting of the frequency lower limit (A062) for forward rotation or the frequency setting of the frequency lower limit (A062) for reverse rotation as shown below.

(a) When operation commands are input via the control circuit terminal block (A002: 01)

Terminal	Motor speed with 0 V input via O2 terminal
FW(ON)	Frequency setting by A062 for forward rotation
RV(ON)	Frequency setting by A062 for reverse rotation

(b) When operation commands are input from the digital operator (A002: 02)

F004	Motor speed with 0 V input via O2 terminal
00	Frequency setting by A062 for forward rotation
01	Frequency setting by A062 for reverse rotation

4.2.21 Jump frequency function

The jump frequency function allows you to operate the inverter so that it avoids the resonant frequency of the machine driven by the same. Since the inverter avoids the motor operation with a constant output frequency within the specified range of the frequencies to jump when the jump frequency function is enabled, you cannot set any inverter output frequency within the specified range of the frequencies to jump. Note that, while the inverter is accelerating or decelerating the motor, the inverter output frequency changes continuously according to the set acceleration/deceleration time. You can set up to three frequencies to jump.

Related code
 A063: Jump (center) frequency setting 1
 A064: Jump (hysteresis) frequency width setting 1
 A065: Jump (center) frequency setting 2
 A066: Jump (hysteresis) frequency width setting 2
 A067: Jump (center) frequency setting 3
 A068: Jump (hysteresis) frequency width setting 3

Item	Function code	Range of data	Description
Jump (center) frequency settings, 1st/2nd/3rd settings	A063/A065/A067	0.00 to 400.0 (Hz) (*1)	Setting of the center frequency of the frequency range to be jumped
Jump (hysteresis) frequency width settings, 1st/2nd/3rd settings	A064/A066/A068	0.00 to 10.00(Hz)	Setting of the half bandwidth of the frequency range to be jumped

*1 Setting of 0 Hz disables the jump frequency function.

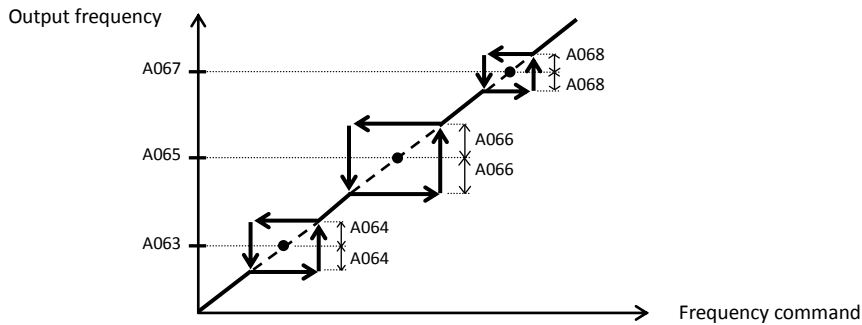

4.2.22 Acceleration stop frequency setting

The acceleration stop frequency setting function allows you to make the inverter wait, upon starting the motor, until the slipping of the motor becomes less when the load on the motor causes a large moment of inertia.

Related code
 A069: Acceleration stop frequency setting
 A070: Acceleration stop time frequency setting

Use this function if the inverter has tripped because of overcurrent when starting the motor.

This function can operate with every acceleration pattern, regardless of the setting of the acceleration curve selection (A097).

Item	Function code	Range of data	Description
Acceleration stop frequency setting	A069	0.00 to 400.0(Hz)	Setting of the frequency at which to stop acceleration
Acceleration stop time frequency setting	A070	0.0 to 60.0(s)	Setting of the length of time to stop acceleration

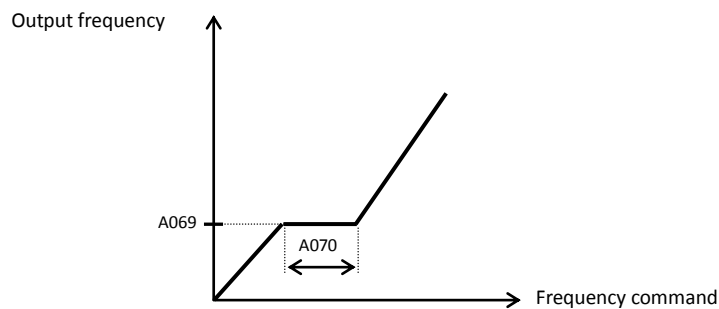

4.2.23 PID function

The PID function allows you to use the inverter for the process control on fluid flow, airflow, and pressure.

To enable this function, specify "01 lenabled" or "02 inverted data output enabled" for function "A071".

You can disable the PID function with an external signal during the PID operation. For this purpose, assign function "23" (PID terminal: disabling PID operation) to an intelligent input terminal. Turning the PID terminal on disables the PID function and makes the inverter perform the normal output.

With the PID function, you can limit the PID output according to various conditions.

Refer to maximum frequency (4.2.10), frequency limiter (4.2.20), PID variation range (A078).

Related code

- A001: Frequency source setting
- A005: [AT] selection
- A006: [O2] selection
- A071: PID Function Enable
- A072: PID proportional gain
- A073: PID integral time constant
- A074: PID derivative gain
- A075: PV scale conversion
- A076: PV source setting
- A077: Output of inverted PID deviation
- A078: PID variation range
- A079: PID feed forward selection
- d004: Process variable (PV), PID feedback monitoring
- C001 to C008: Terminal [1] to [8] functions
- C021 to C025: Terminal [11] to [15] functions
- C044: PID deviation level setting
- C052: Off level of feedback comparison signal
- C053: Onlevel of feedback comparison signal

Item	Function code	Data or range of data	Description
PID Function Enable	A071	00	Disabling the PID operation
		01	Enabling the PID operation
		02	Enabling inverted-data output
PID proportional gain	A072	0.2 to 5.0	Proportional gain
PID integral time constant	A073	0.0 to 3600.(s)	Integrated gain
PID derivative gain	A074	0.00 to 100.0(s)	Derivative gain
PV scale conversion	A075	0.01 to 99.99	Scale for unit conversion of PID feedback data
PV source setting	A076	00	OI-L: 4 to 20 mA
		01	O-L: 0 to 10 V
		02	RS485 communication
		03	Frequency command as pulse train
		10	Operation result (*1)
Output of inverted PID deviation	A077	00	Disabling the inverted output
		01	Enabling the inverted output (deviation polarity inverted)
PID variation range	A078	0.0 to 100.0(%)	Range of PID data variation with reference to the target value
PID feed forward selection	A079	00	Invalid
		01	O-L : 0-10V
		02	OI-L : 4-20mA
		03	O2-L : -10-10V
PID deviation level setting	C044	0.0 to 100.0(%)	Level to determine the OD signal output
Off level of feedback comparison signal	C052	0.0 to 100.0(%)	Level to determine the FBV signal output
Onlevel of feedback comparison signal	C053	0.0 to 100.0(%)	Level to determine the FBV signal output

(*1) refer 4.2.12 Frequency operation function

(1) Basic configuration of PID control

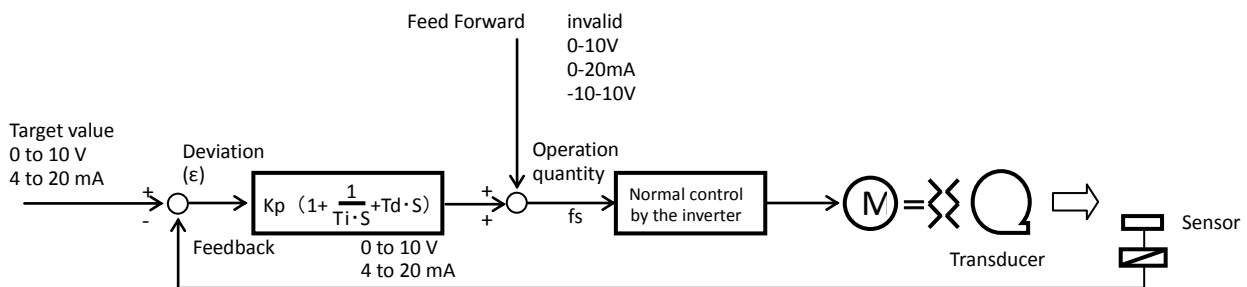

Kp: Proportional gain Ti: Integral time Td: Derivative time s: Operator ε: Deviation

(2) PID operation

1) P operation

The proportional (P) operation stands for the operation in which the change in operation quantity is in proportion to the change in target value.

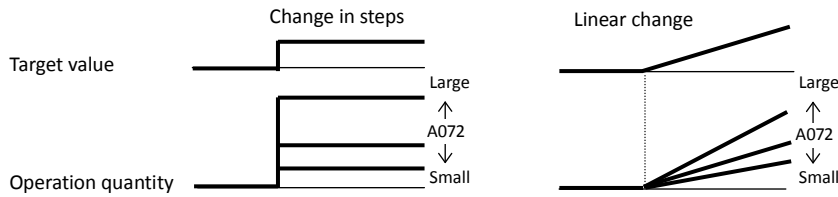

2) I operation

The integral (I) operation stands for the operation in which the operation quantity increases linearly over time.

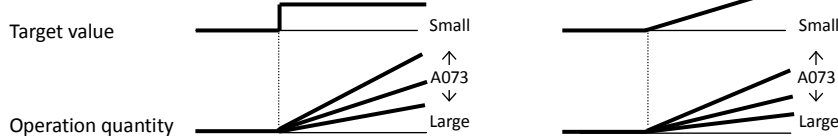

3) D operation

The derivative (D) operation stands for the operation in which the operation quantity changes in proportion to the rate of change in the target value.

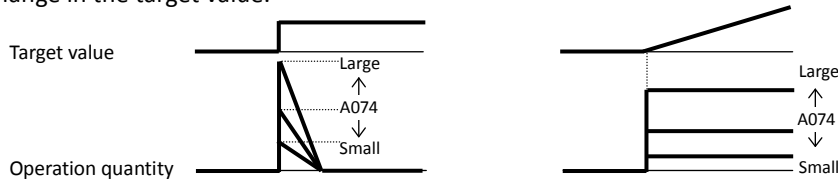

The PI operation is a combination of the P operation 1) and I operation 2). The PD operation is a combination of the P operation 1) and D operation 3). The PDI operation is a combination of the P operation 1), I operation 2), and D operation 3).

(3) PV source setting

Select the terminal to be used for the feedback signal with the PV source setting function (A076).

The terminal to input the target value follows the frequency source setting (A001). The terminal selected by the PV source setting (A076) is excluded.

If the control circuit terminal block ("01") has been specified for frequency source setting "A001", the setting of AT selection (A005) is invalid.

The table below shows how the PID target value is selected according to the setting of "A006" when the analog input is selected by the PV source setting and the control circuit terminal block ("01") is specified for "A001".

PV source setting (A076)		PID target value			
		A006=00	A006=01	A006=02	A006=03
00 (OI-L)		O + O2 (non-reversible)	O + O2 (reversible)	O	
01 (O-L)		OI + O2 (non-reversible)	OI + O2 (reversible)	OI	
10 (operation result)	Operation targets include the input to the OI terminal.	O + O2 (non-reversible)	O + O2 (reversible)	O	
	Operation targets include the input to the O terminal.	OI + o2 (non-reversible)	OI + O2 (reversible)	OI	
	Operation targets are the inputs to the OI and O terminals.	O2 (reversible)			

When you specify the 02 RS485 communication for the PV source setting (A076), transfer data as described below.

- 1) When the ASCII mode is selected (C078 = 00)
 - Use the 01 command for data transfer. To transfer feedback data, set the most-significant byte of frequency data to "1".
 - Example: When transmitting the frequency data specifying 5 Hz
 The data to be transmitted consists of six bytes, indicating a value 100 times as large as the set frequency value. → "000500"
 Change the most-significant byte to "1". → "100500"
 Convert the data to ASCII format. → "31 30 30 35 30 30"
 - Note: In ASCII mode, the unit of setting is always frequency (Hz).
- 2) When the Modbus RTU mode is selected (C078 = 01)
 - Write the setting data (on the assumption that "10000" indicates 100%) to register address 0006h.

Register No.	Function name	Function code	Readable/writable (R/W)	Monitored data or setting	Data resolution
0006h	PID feedback	—	R/W	0 to 10000	0.01 [%]

Note: This register is readable and writable. However, this register can be read only when Modbus RTU has been specified as the communication mode for PID feedback. It cannot be read with other settings.

- When pulse train input is specified for PID feedback, the input pulse train frequency (Hz) is converted to a percentage (with maximum frequency corresponding to 100%) and fetched as the feedback.
- For the pulse train input frequency, see Section 4.3.21.

(4) Feed forward selection

- Select the terminal to be used for the feed forward signal through PID feed forward selection (A079).
- Even if the terminal selected for the target or feedback data is also selected for the terminal by A079, the terminal functions according to the setting of A079.
- Specifying the value to disable selection for A079 disables feed forward control.

(5) Output of inverted PID deviation

Some sensor characteristics may cause the polarity of the deviation of feedback data from the target value to be inconsistent with the inverter operation command. If the inconsistency occurs, specify "01" for function "A077" to invert the polarity of the deviation.

Example: When controlling the compressor for a refrigerator

Assume that the temperature and voltage specifications of the temperature sensor are -20°C to +100°C and 0 to 10 V and the target value is 0°C.

If the current temperature is 10°C and the inverter is under the normal type of PID control, the inverter will reduce the output frequency because the feedback data is larger than the target value.

→ In such a case, specify "01" for function "A077" to invert the feedback deviation. Then, the inverter will increase the output frequency.

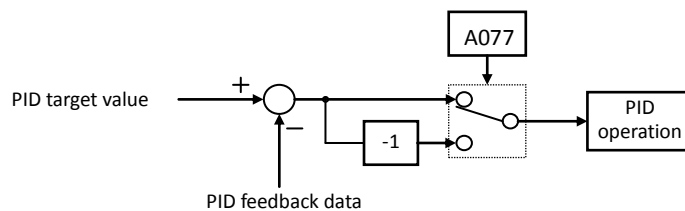

(6) Limitation on PID variation range

You can limit the PID output to within a specific range with reference to the target value.

To use the PID variation limit function, set the PID variation range (A078).

(Set a value on the assumption that the maximum frequency corresponds to 100%.)

The variation of PID output is limited within ±"value of A078" from the target value.

(Setting "0.0" for the PID variation range [A078] disables the PID variation limit function.)

This function is deactivated when 0.0 is set on A078.

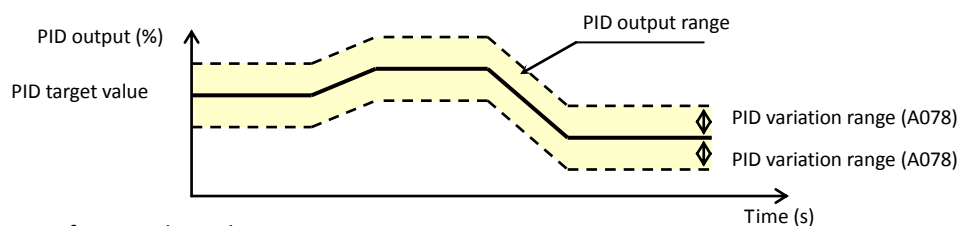

(7) Output of inverted PID deviation

If the inverter is under the normal PID control and the PID operation result is a negative value, the frequency command to the inverter will be limited to 0 Hz. However, when "02" (enabling the inverted output) is set for the PID

Function Enable (A071), the PID operation result to be output to the inverter is inverted if the result is a negative value.

Setting "02" for function "A071" disables the PID variation limit (A078) described above.

(8) PID gain adjustment

If the inverter response is unsteady when the PID control function is used, try to adjust gain settings as follows:

- If the feedback data does not quickly follow the change in the target value → Increase the P gain (A072).
- If the feedback data is unstable although it quickly follows the change in the target value → Reduce the P gain (A072).
- If considerable time is required until the feedback data matches the target value → Reduce the I gain (A073).
- If the feedback data fluctuates unsteadily → Increase the I gain (A073).
- If the inverter response is slow even after the P gain is increased → Increase the D gain (A074).
- If the feedback data becomes fluctuant and unsteady when the P gain is increased → Reduce the D gain (A074).

(9) Maximum PID deviation output (OD)

You can set the PID deviation level (C044) for PID control. When the PID deviation (ϵ) exceeds the level set as the level "C044", the signal is output to an intelligent output terminal.

A value from 0 to 100 can be set as the level "C044". The range of values corresponds to the range of target values from 0 to the maximum.

To use this output function, assign function "04" (OD) to one of the terminal functions C021 to C025 or the alarm relay terminal function C026.

(10) Feedback comparison signal

A feedback comparison signal can be output to an intelligent output terminal when the PID feedback data exceeds the specified range.

To use this signal output function, assign function "31" (FBV) to one of the terminal functions C021 to C025 or the alarm relay terminal function C026.

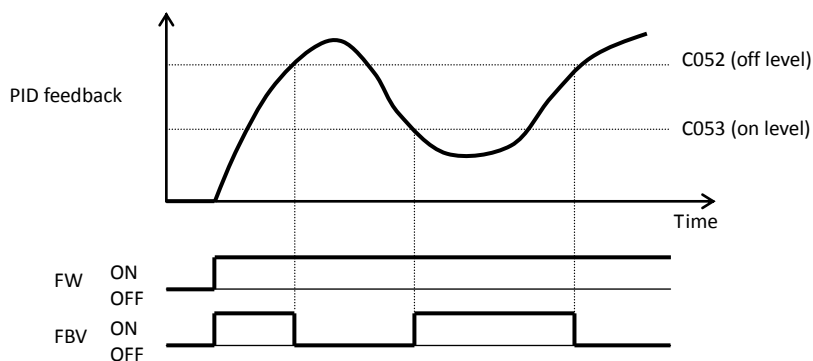

(11) Process variable (PV), PID feedback monitoring (d004)

You can monitor the PID feedback data on the inverter.

When you set a PV scale conversion with function "A075", the value to be displayed as the monitored data can be the product of the feedback data and the scale.

"Monitored value" = "feedback data (%)" x "PV scale conversion (A075)"

(12) Reset of PID integration (PIDC)

This reset function clears the integral result of PID operation.

To use this function, assign function "24" (PIDC) to one of the terminal functions C001 to C008.

The integral result is cleared each time the PIDC terminal is turned on.

Never turn on the PIDC terminal during the PID operation. Otherwise, the inverter may trip because of overcurrent. Be sure to disable the PID function before turning on the PIDC terminal.

4.2.24 Two-stage acceleration/deceleration function (2CH)

The two-stage acceleration/deceleration function allows you to change the acceleration or deceleration time while the inverter is accelerating or decelerating the motor.

Select one of the following three methods of changing the acceleration or deceleration time:

- 1) Changing the time by the signal input to an intelligent input terminal
- 2) Automatically changing the time when the output frequency reaches a specified frequency
- 3) Automatically changing the time only when switching the motor operation from forward rotation to reverse rotation, or vice versa

Related code	
F002/F202/F302:	Acceleration (1) time setting, 1st/2nd/3rd motors
F003/F203/F303:	Deceleration (1) time setting, 1st/2nd/3rd motors
A092/A292/A392:	Acceleration (2) time setting, 1st/2nd/3rd motors
A093/A293/A393:	Deceleration (2) time setting, 1st/2nd/3rd motors
A094/A294:	Select method to switch to Acc2/Dec2 profile, 1st/2nd motor
A095/A295:	Acc1 to Acc2 frequency transition point, 1st/2nd motors
A096/A296:	Dec1 to Dec2 frequency transition point, 1st/2nd motors
C001 to C008:	Terminal [1] to [8] functions

Selecting the 3rd control system enables the change of the acceleration or deceleration time only by terminal input. Not by two-stage acceleration/deceleration frequency. To change the acceleration/deceleration time by the signal input to an intelligent input terminal, assign function "09" (2CH) to one of the terminal functions C001 to C008.

Item	Function code	Data	Description
Acceleration (2) time setting	A092/A292/A392	0.01 to 3600. (s)	(See examples 1 and 2.)
Deceleration (2) time setting	A093/A293/A393	0.01 to 3600. (s)	(See examples 1 and 2.)
Select method to switch to Acc2/Dec2 profile	A094/A294	00	Changing the time by the signal input to the 2CH terminal (See example 1.)
		01	Changing the time at the two-stage acceleration/deceleration frequency (See example 2.)
		02	Valid only while the inverter is switching the motor between forward and reverse operations (See example 3.)
Acc1 to Acc2 frequency transition point	A095/A295	0.00 to 400.0 (Hz)	Valid when "01" is specified for the select method to switch to Acc2/Dec2 profile (A094/A294) (See example 2.)
Dec1 to Dec2 frequency transition point	A096/A296	0.00 to 400.0 (Hz)	Valid when "01" is specified for the Select method to switch to Acc2/Dec2 profile (A094/A294) (See example 2.)

(Example 1) When "00" is specified for "A094" or "A294"

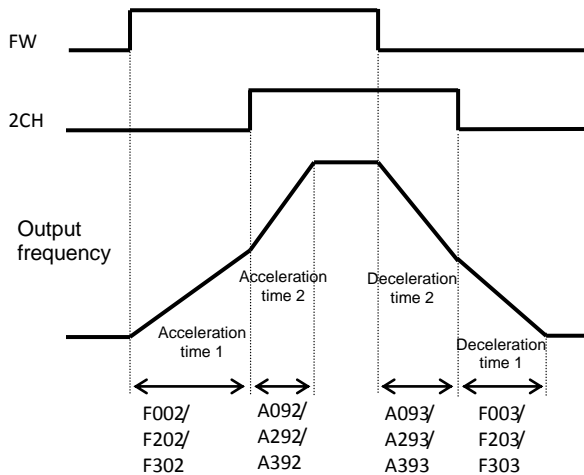

(Example 2) When "01" is specified for "A094" or "A294"

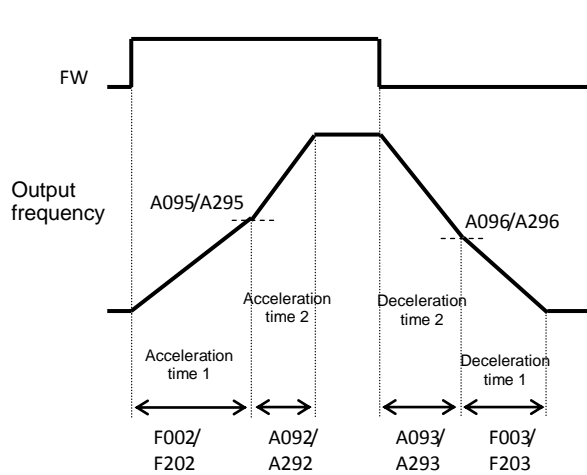

(Example 3) When "02" is specified for "A094" or "A294"

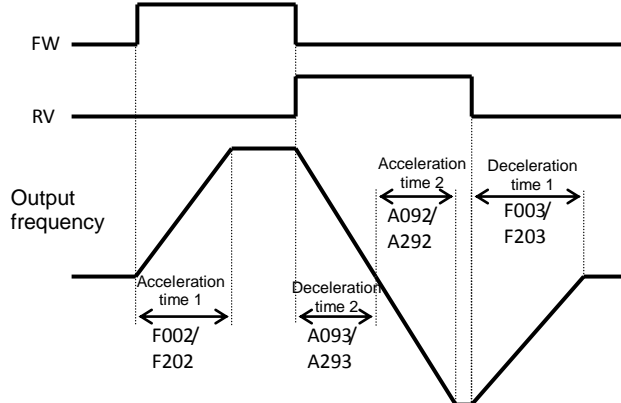

4.2.25 Acceleration/deceleration curve selection

You can set different patterns of motor acceleration and deceleration according to the type of system to be driven by the inverter. Use functions "A097" and "A098" to select acceleration and deceleration patterns, respectively.

You can individually set an acceleration pattern for acceleration and a deceleration pattern for deceleration. When the acceleration/deceleration pattern is set other than 00 (linear) using analog input as frequency source is to be avoided because it prolongs the acceleration or deceleration time.

— Related code —

A097: Acceleration curve selection
 A098: Deceleration curve setting
 A131: Acceleration curve constants setting
 A132: Deceleration curve constants setting
 A150: Curvature for EL-S-curve acceleration 1
 A151: Curvature for EL-S-curve acceleration 2
 A152: Curvature for EL-S-curve deceleration 1
 A153: Curvature for EL-S-curve deceleration 2

Item	Function code	Data or range of data	Description
Acceleration/deceleration curve selection	A097/A098	00	Linear acceleration/deceleration
		01	S-curve acceleration/deceleration
		02	U-curve acceleration/deceleration
		03	Inverted-U-curve acceleration/deceleration
		04	EL-S-curve acceleration/deceleration
Acceleration/deceleration curve constants setting	A131/ A132	01 to 10	01 (small degree of swelling) <div style="text-align: center;">◆</div> 10 (large degree of swelling)
Curvature for EL-S-curve acceleration 1/2	A150/A151	0 to 50 (%)	Curvature of EL-S curve (for acceleration)
Curvature for EL-S-curve deceleration 1/2	A152/A153	0 to 50 (%)	Curvature of EL-S curve (for deceleration)

(1) Acceleration/deceleration pattern selection

Select acceleration and deceleration patterns with reference to the following table:

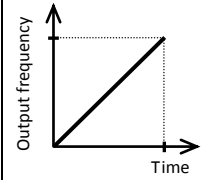
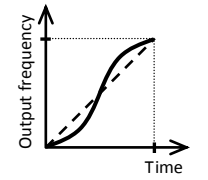
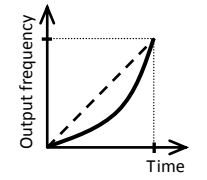
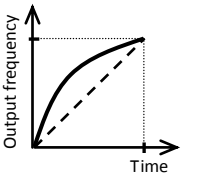
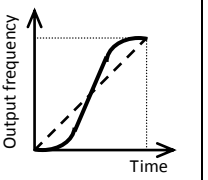
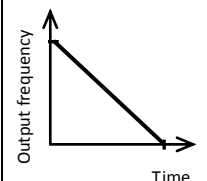
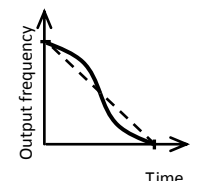
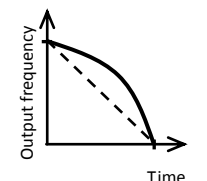
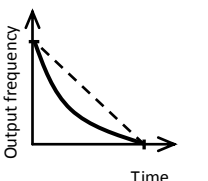
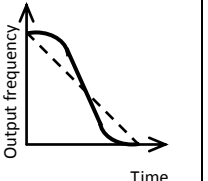
Setting	00	01	02	03	04
Curve	Linear	S curve	U curve	Inverted-U curve	EL-S curve
A097 (acceleration pattern)					
A098 (deceleration pattern)					
Description	With this pattern, the motor is accelerated or decelerated linearly until its speed reaches the set output frequency.	This pattern is effective for preventing the collapse of cargo carried by a lift or conveyor driven by the inverter.	This pattern is effective for the tension control on a winding machine driven by the inverter (to prevent cutting of the object to be wound).		This pattern is similar to the S-curve pattern for the shockless starting and stopping of the motor, except that the middle section of this pattern is linear.

(2) Curve constant (swelling degree)

Specify the swelling degree of the acceleration curve with reference to the following graphs:

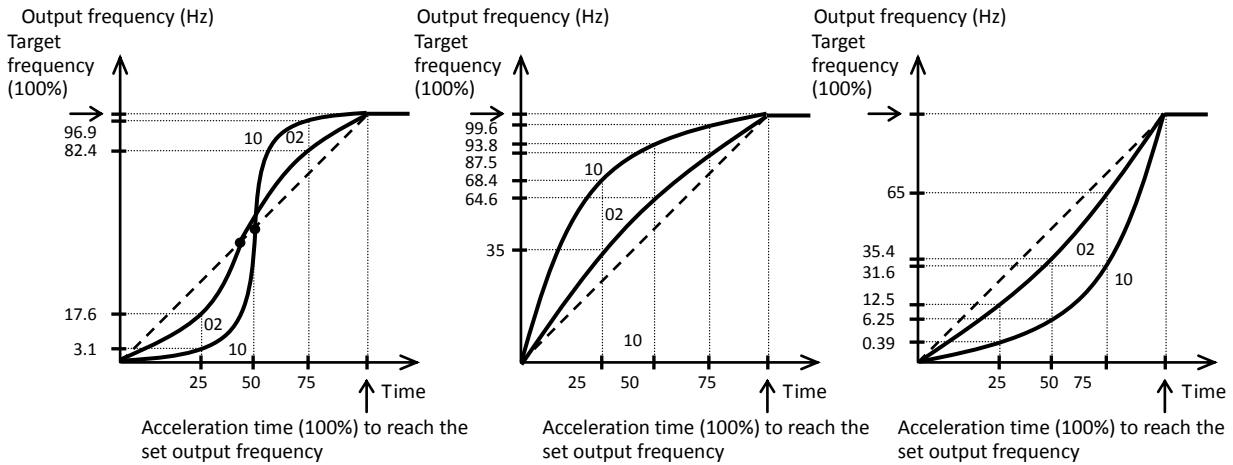

The acceleration or deceleration time may be shortened midway through the acceleration or deceleration according to the S-curve pattern.

If the LAD cancellation (LAC) function has been assigned to an intelligent input terminal and the LAC terminal is turned on, the selected acceleration and deceleration patterns are ignored, and the output frequency is quickly adjusted to that specified by the frequency command.

(3) Curvature of EL-S-curve pattern

When using the EL-S-curve pattern, you can set the curvatures (A150 to A153) individually for acceleration and deceleration.

If all curvatures are set to 50%, the EL-S-curve pattern will be equivalent to the S-curve pattern.

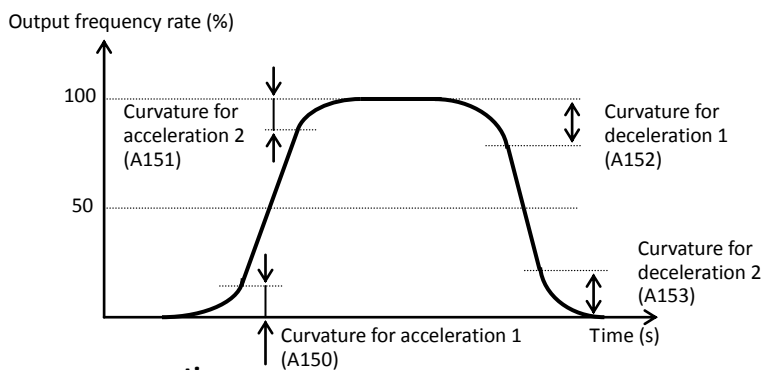

4.2.26 Energy-saver operation

The energy-saver operation function allows you to automatically minimize the inverter output power while the inverter is driving the motor at constant speed. This function is suited to operating a fan, pump, or other load that has a reduced-torque characteristic.

To use this function, specify "01" for the operation mode selection (A085).

Use the energy saving mode tuning function (A086) to adjust the response and accuracy of the energy-saver operation. The energy-saver operation function controls the inverter operation comparatively slowly. Therefore, if a sudden change in the load occurs (e.g., impact load is applied), the motor may stall, and, consequently, the inverter may trip because of overcurrent.

Related code
 A085: Operation mode selection
 A086: Energy saving mode tuning

Item	Function code	Data	Description
Operation mode selection	A085	00	Normal operation
		01	Energy-saving operation
		02	Fuzzy operation

Item	Function code	Data	Response	Accuracy
Energy saving mode tuning	A086	0	Slow	High
		◇	◇	◇
		100	Quick	Low

4.2.27 Retry or trip after instantaneous power failure

(1) Retry (restart) after instantaneous power failure

- You can select tripping or retrying (restarting) the motor operation as the inverter operation to be performed at the occurrence of instantaneous power failure or undervoltage.
- If you specify a retry operation for the selection of restart mode (b001), the inverter will retry the motor operation for the number of times set as "b005" after an instantaneous power failure or the number of times set as "b009" after overvoltage respectively, and then trip if all retries fail. (The inverter will not trip if you specify an unlimited number of retries.)
- With function "b004" you can select whether to make the inverter trip when an instantaneous power failure or undervoltage occur while the inverter is in a stopped state.
- When selecting a retry operation, also set the retry conditions listed below according to the system to be driven by the inverter.
- Even during a retry operation, the inverter will trip with error code "E09" (undervoltage) displayed if the undervoltage status continues for 40 seconds.

Related code

b001: Selection of restart mode
 b002: Allowable under-voltage power failure time
 b003: Retry wait time before motor restart
 b004: Instantaneous power failure/under-voltage trip alarm enable
 b005: Number of restarts on power failure/under-voltage trip events
 b007: Restart frequency threshold
 b008: Selection of retry count after undervoltage
 C021 to C025: Terminal [11] to [15] functions
 C026: Alarm relay terminal function

Item	Function code	Data or range of data	Description
Selection of restart mode (*4) (*6)	b001	00	Tripping
		01	Restarting the motor with 0 Hz at retry
		02	Starting the motor with a matching frequency at retry (See example 1.) (*3)
		03	Starting the motor with a matching frequency at retry The inverter trips after decelerating and stopping the motor. (*1) (*3)
		04	Restarting the motor with an input frequency at retry (See example 1.) (*3)
Allowable under-voltage power failure time	b002	0.3 to 25.0 (s)	Restarting the motor when the power failure duration does not exceed the specified time (See example 1.) Tripping when the power failure duration exceeds the specified time (See example 2.)
Retry wait time before motor restart	b003	0.3 to 100. (s)	Time to wait until restarting the motor
Instantaneous power failure/under-voltage trip alarm enable (*2) (*4)	b004	00	Disabling the inverter from tripping
		01	Enabling the inverter to trip
		02	Disabling the inverter from tripping when the inverter is stopped or while the motor is being decelerated or stopped after the operation command has been turned off
Number of restarts on power failure/under-voltage trip events	b005	00	Retrying the motor operation up to 16 times after instantaneous power failure
		01	Retrying the motor operation an unlimited number of times after instantaneous power failure
Restart frequency threshold	b007	0.00 to 400.0 (Hz)	Restarting the motor with 0 Hz if the frequency becomes less than the frequency set here during motor free-running (See examples 3 and 4.)
Trip/retry selection	b008	00	Tripping
		01	Restarting the motor with 0 Hz at retry
		02	Starting the motor with a matching frequency at retry
		03	Starting the motor with a matching frequency at retry The inverter trips after decelerating and stopping the motor.
		04	Restarting the motor with an input frequency at retry
Selection of retry count after undervoltage	b009	00	Retrying the motor operation up to 16 times after undervoltage
		01	Retrying the motor operation an unlimited number of times after undervoltage
Selection of retry count after overvoltage or overcurrent	b010	1 to 3 (times)	Number of retries to be made after the occurrence of overvoltage or overcurrent (*5)
Retry wait time after overvoltage or overcurrent	b011	0.3 to 100. (s)	Time to wait until restarting the motor
Active frequency matching, restart frequency select	b030	00	Frequency set when the inverter output has been shut off
		01	Maximum frequency
		02	Newly set frequency
Active frequency matching, scan start frequency	b028	CT mode 0.20 to 2.00 x rated current <0.20 to 1.80 x rated current> VT mode 0.20 to 1.50 x rated current <0.20 to 1.50 x rated current>	Current limit for restarting with active matching frequency
Active frequency matching, scan-time constant	b029	0.10 to 30.00 (s)	Duration of frequency lowering when restarting with active matching frequency

(NOTE) <>:applied for 75 to 150kW

- *1 If the inverter trips because of overvoltage or overcurrent while decelerating the motor, the inverter will display error code "E16" (instantaneous power failure), and the motor will start free-running. If this error occurs, prolong the deceleration time.
- *2 If a DC voltage (P-N) is supplied to control power supply terminals R0 and T0, the inverter may detect undervoltage and trip when the inverter power is turned off. If this cause a problem in your system, specify "00" or "02" for the trip selection.
- *3 The inverter may start the motor with 0 Hz if:
 - 1) the output frequency is not more than half the base frequency or
 - 2) the voltage induced on the motor is attenuated quickly.
- *4 Even when a retry operation (01 to 03) is specified for the selection of restart mode (b001) and "disabling tripping" (00 or 02) is specified for the selection of a trip after instantaneous power failure or undervoltage in the stopped state, the inverter will trip if the instantaneous power failure continues over the allowable under-voltage power failure time. (See example 2.)
- *5 Even when a retry operation is specified for the trip selection, the inverter will trip if the cause of trip is not removed by the end of the retry wait time before motor restart (b003). If this occurs, prolong the retry wait time.
- *6 Even when a retry operation is specified for the retry selection, the inverter will trip if the undervoltage status continues for 40 seconds or more.
- *7 when starting the motor with matching frequency is selected, inverter may restart suddenly by alarm resetting, resetting and retry-start.

The figures below show the timing charts for starting with a matching frequency (when "02" is specified for the selection of restart mode [b001]).

t0: Duration of instantaneous power failure
 t1: Allowable under-voltage power failure time (b002)
 t2: Retry wait time before motor restart (b003)

(Example 1)

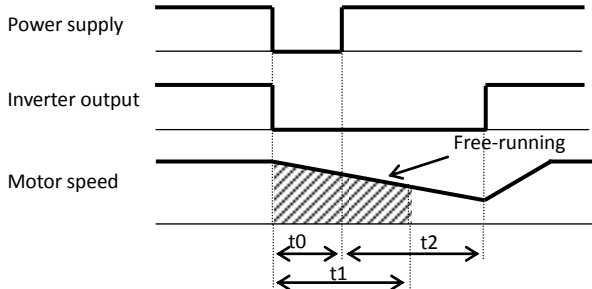

(Example 2)

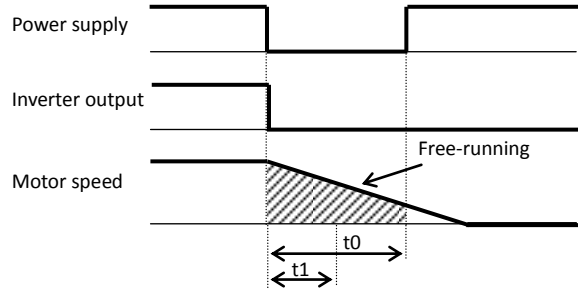

(Example 3) When the motor frequency (speed) is more than the setting of "b007":

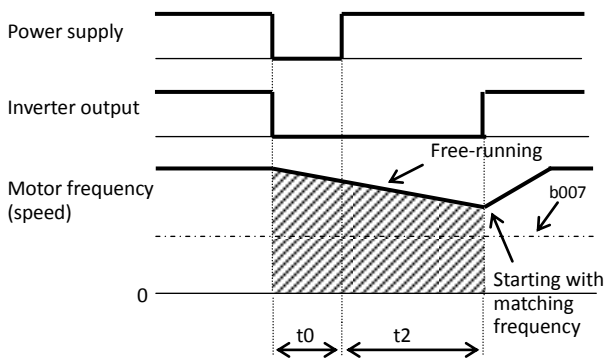

(Example 4) When the motor frequency (speed) is less than the setting of "b007":

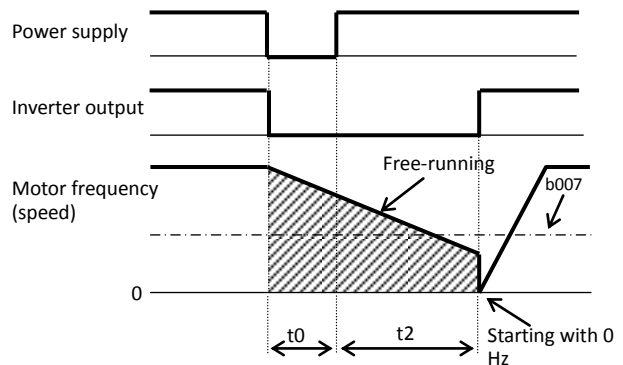

(2) Output of the alarms for instantaneous power failure and undervoltage in the stopped state

Use function "b004" to specify whether to output an alarm when instantaneous power failure or undervoltage occurs. The inverter outputs the alarm providing the control power remains in the inverter.

Output of the alarms for instantaneous power failure and undervoltage in the stopped state

Examples 5 to 7 show the alarm output operations with standard settings. Examples 8 to 10 show the alarm output operations with the settings to supply DC power (P-N) to control power supply terminals R0 and T0.

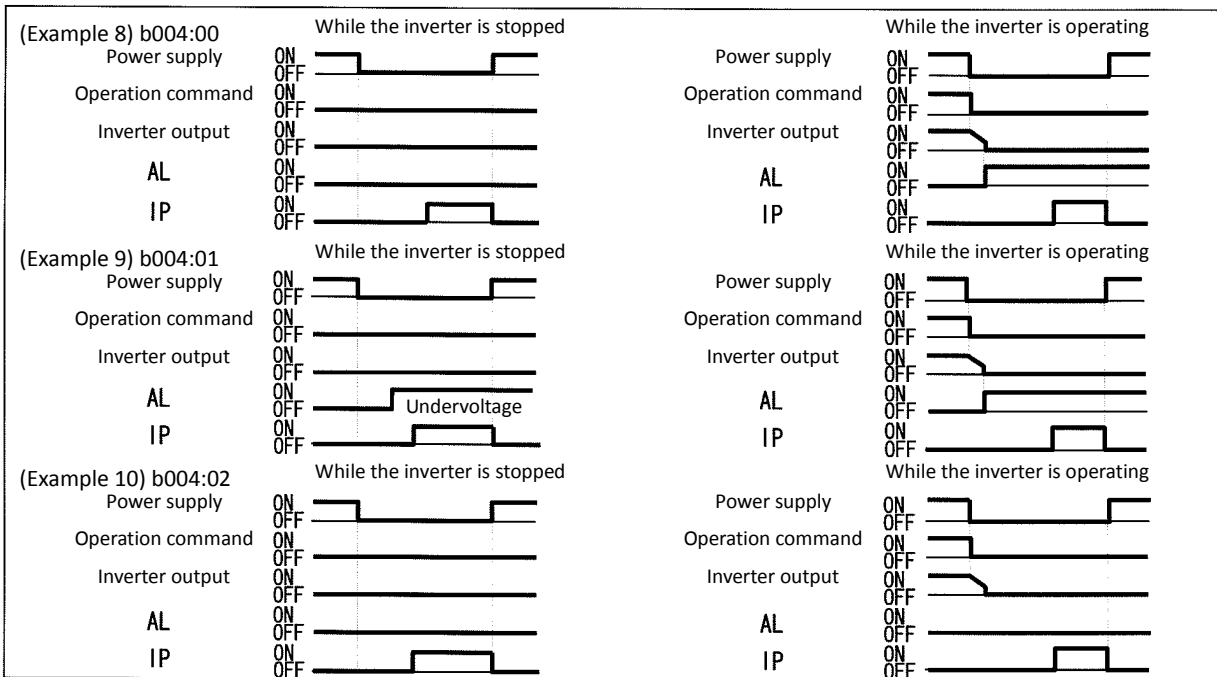
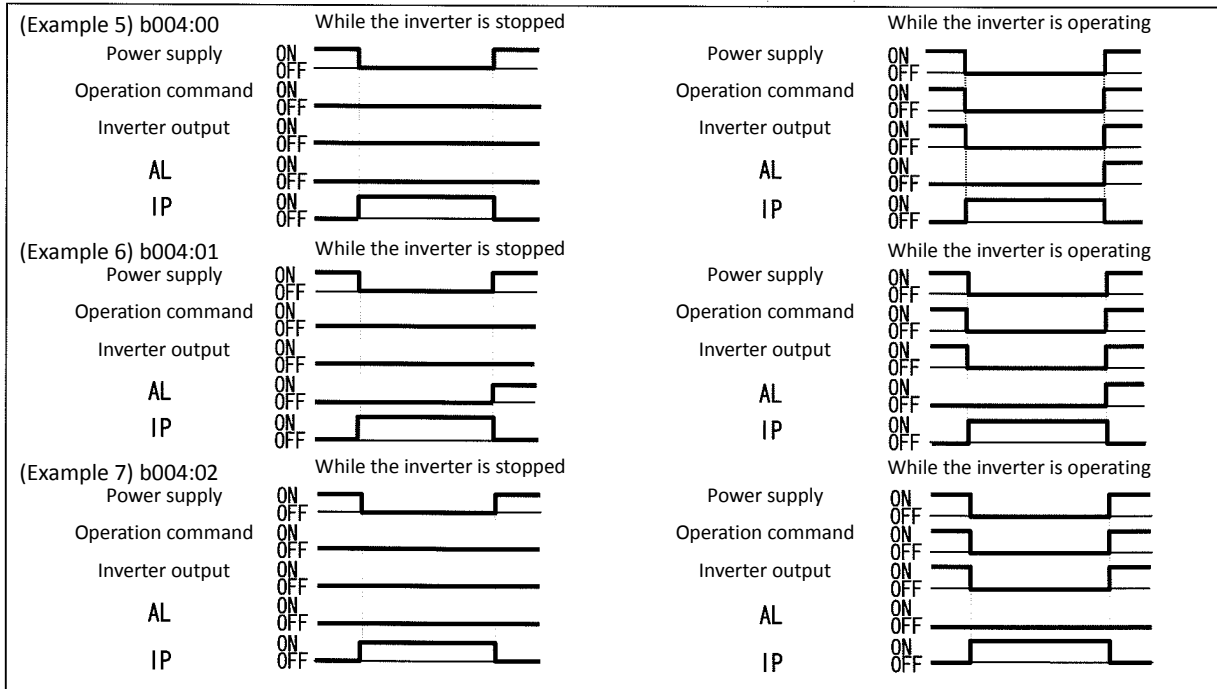

Note 1: You can assign the instantaneous power failure alarm signal (IP: 08) and the undervoltage alarm signal (UV: 09) to any of the intelligent output terminals [11] to [15] (C021 to C025) and the alarm relay terminal (C026) to output the alarm signals.

Note 2: For the alarm output following the occurrence of power failure of 1 second or longer, see the explanation of reset (Section 4.2.48).

(3) Restarting methods

- Restart with matching frequency

The inverter detects the frequency and rotation direction based on the residual voltage in the motor, and then restarts the motor based on the detected frequency.

- Restart with input frequency

The inverter starts the output with the frequency specified for the start frequency selection (b030), searches for the point where the frequency and voltage are balanced while keeping the current at the restart current level (b028), and then restarts the motor.

If the inverter trips when it restarts the motor in this way, reduce the setting of "b028".

- After the inverter output has been shut off, the digital operator continues to display □□□□ until the inverter restarts the motor operation.

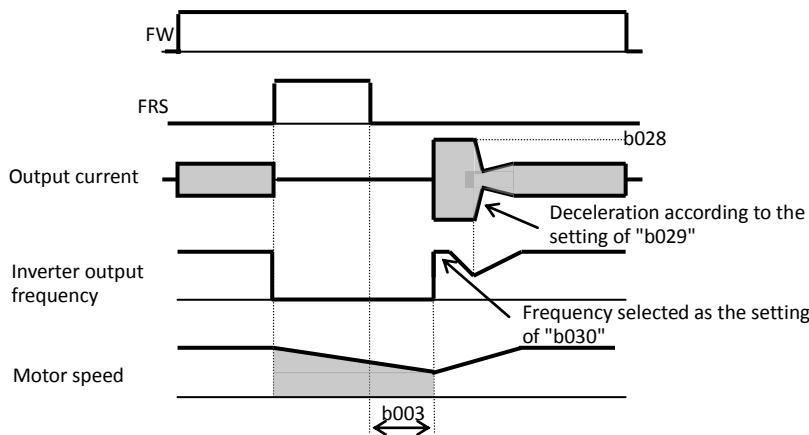

4.2.28 Input/Output phase loss protection

(1) Input phase loss protection

The input phase loss protection function gives a warning when phase loss power is input to the inverter.

Related code
b006: Input phase loss detection enable

Item	Function code	Data	Description
Input phase loss detection enable	b006	00	Disabling the protection
		01	Enabling the protection

An phase loss power input may cause the following conditions, resulting in an inverter failure:

- The ripple current increases in the main capacitor, and the capacitor life will be shortened significantly.
- When the inverter is connected to a load, the internal converter or thyristor of the inverter may be damaged.

(2) Output phase loss protection

The output phase loss protection function gives a warning when output state on the inverter is phase loss.

Related code
b141: Output phase loss detection enable
b142: Output loss detection sensibility

Item	Function code	Data	Description
Output loss detection enable	b141	00	Disabling the protection
		01	Enabling the protection
Output loss detection sensibility	b142	1~100%	Detection sensibility of phase loss detection

An output phase loss may cause the motor is not running smoothly.

When you choose the size smaller capacity motor than the inverter capacity, phase loss warning may occur without output phase loss. In this case, you should decrease the sensibility at b142 or set b141 = 00.

4.2.29 Electronic thermal protection

The electronic thermal protection function allows you to protect the motor against overheating. Make settings of this function based on the rated current of the motor. The inverter will trip for overheat protection according to the settings.

This function provides optimum overheat protection that is also designed with the lowering of the motor's cooling performance at low speeds in mind.

You can configure this function so that the inverter outputs a warning signal before it trips for electronic thermal protection.

Related code

b012/b212/b312: Electronic thermal setting (calculated within the inverter from current output), 1st/2nd/3rd motors
 b013/b213/b313: Electronic thermal characteristic, 1st/2nd/3rd motors
 b015/b017/b019: Free setting, electronic thermal frequency (1) (2) (3)
 b016/b018/b020: Free setting, electronic thermal current (1) (2) (3)
 C021 to C025: Terminal [11] to [15] functions
 C026: Alarm relay terminal function
 C061: Electronic thermal warning level setting

(1) Electronic thermal level

Item	Function code	Range of data	Description
Electronic thermal setting (calculated within the inverter from current output)	b012/b212/b312	0.2 to 1.0 x rated current	See the example below.

(Example) Setting on the SJ700-150LFF(0.4-55kW)

CT mode rated current: 64 A

Range of setting: 12.8 A (20%) to 64.0 A (100%)

When 64 A is set as the electronic thermal setting (b012), the time-limit characteristic is as shown on the right.

Trip time (s)

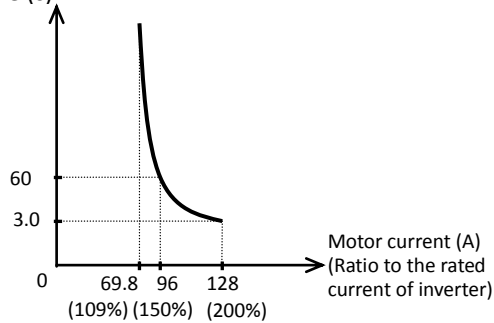

(Example) Setting on the SJ700-750LFF3(75-150kW)

CT mode rated current: 149 A

Range of setting: 29.8 A (20%) to 149 A (100%)

When 149 A is set as the electronic thermal setting (b012), the time-limit characteristic is as shown on the right.

Trip time (s)

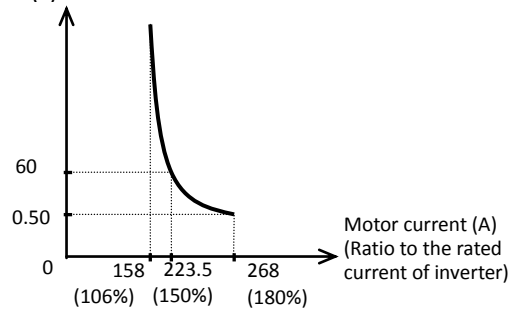

(2) Electronic thermal characteristic

The frequency characteristic set as the electronic thermal characteristic is integrated with the value of "b012", "b212", or "b312".

The cooling-fan performance of a general-purpose motor lowers when the motor speed is low. So load (current) is decreased. The reduced-torque characteristic is designed to match the heat generation by Hitachi's general-purpose motors.

Item	Function code	Data	Description
Electronic thermal characteristic	b013/b213/b313	00	Reduced-torque characteristic
		01	Constant-torque characteristic
		02	Free setting of electronic thermal characteristic

(a) Reduced-torque characteristic

The time-limit characteristic determined by the value of "b012", "b212", or "b312" is integrated with each frequency multiplied by reduction scales.

Example) Setting on the SJ700D-150LFF3 (CT mode rated current: 64 A)

When "b012" is 64 A, the base frequency is 60 Hz, and output frequency is 20 Hz:

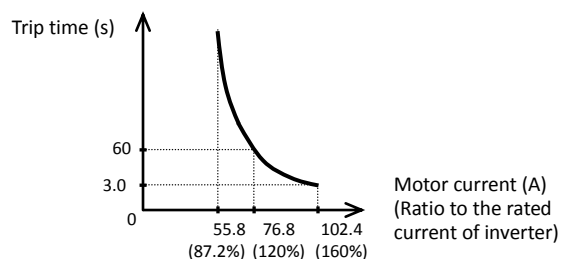
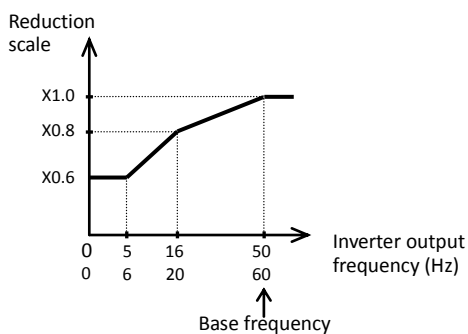

(b) Constant-torque characteristic

Make this setting when driving a constant-torque motor with the inverter.

(Example) Setting on the SJ700D-150LFF3 (CT mode rated current: 64 A)
When "b012" is 64 A, and output frequency is 2.5 Hz:

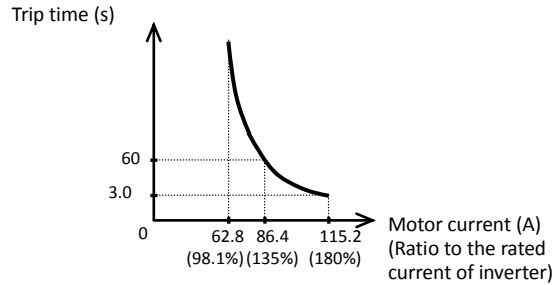
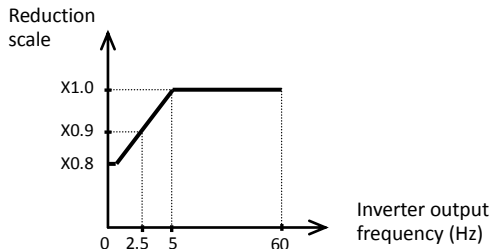

(c) Free setting of electronic thermal characteristic

To protect the motor against overheating, you can set the electronic thermal characteristic freely according to the load on the motor.

The range of setting is shown in the figures below.

Item	Function code	Range of data	Description
Free setting, electronic thermal frequency (1) (2) (3)	b015/b017/ b019	0. to 400. (Hz)	Setting of frequency at each breakpoint
Free setting, electronic thermal current (1) (2) (3)	b016/b018/ b020	0.0 (A)	Disabling the electronic thermal protection
		0.1 to rated current. (A)	Setting of the current at each breakpoint

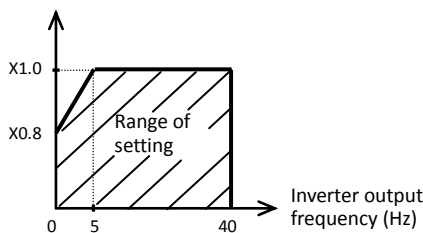

(Example) When the output frequency is equal to the setting of "b017"

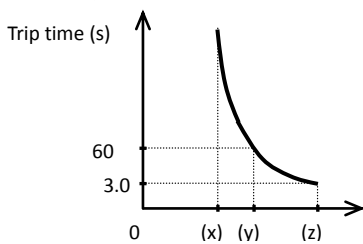
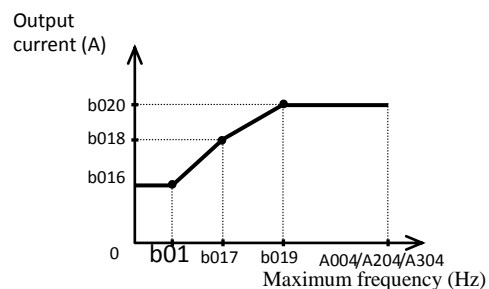

(x): ("setting of b018"/"rated current") x 109%
(y): ("setting of b018"/"rated current") x 150%
(z): ("setting of b018"/"rated current") x 200%

(3) Thermal warning

You can configure this function so that the inverter outputs a warning signal before the electronic thermal protection operates against motor overheat. You can also set the threshold level to output a warning signal with the electronic thermal warning level setting (C061).

To output the warning signal, assign function "13" (THM) to one of the intelligent output terminals [11] to [15] (C021 to C025) and the alarm relay terminal (C026).

Item	Function code	Data	Description
Electronic thermal warning level setting	C061	0.	Disabling the warning output
		1. to 100. (%) (*1)	Setting of the threshold level to output the thermal warning signal

*1 Set the ratio (%) of the warning level to the integrated value of the electronic thermal characteristic. A setting of 100% corresponds to the inverter trip due to overload (error code "E05").

4.2.30 Overload restriction/overload notice

(1) Overload restriction function

- The overload restriction function allows you to make the inverter monitor the motor current during acceleration or constant-speed operation and automatically reduce the output frequency according to the deceleration rate at overload restriction when the motor current reaches the overload restriction level.
 - This function prevents the moment of inertia from excessively increasing during motor acceleration and prevents the inverter from tripping because of overcurrent, even when the load changes suddenly during the constant-speed operation of the motor.
 - You can specify two types of overload restriction operation by setting functional items "b021", "b022", and "b023" and functional items "b024", "b025", and "b026" separately.
 - To switch the overload restriction operation between the two settings (setting with b021, b022, and b023 and setting with b024, b025, and b026), assign function "39" (OLR) to an intelligent input terminal. Turn the - OLR signal on and off to switch between the two settings.
 - The overload restriction level specifies the current at which to trigger the overload restriction function.
 - The deceleration rate at overload restriction specifies the length of time to decelerate the motor from the maximum frequency to 0 Hz.
 - When this function operates during deceleration, the acceleration time is prolonged over the set time.
- When you have selected the sensorless vector control, 0Hz-range sensorless vector control, or vector control with sensor as the V/F characteristic curve selection (see Section 4.2.18) and "03" for "b021" or "b024", the inverter output frequency increases if the current over the overload restriction level flows during the regenerative operation. If the value set as the deceleration rate at overload restriction (b023/b026) is too small, the inverter automatically decelerates the motor even during acceleration because of the overload restriction, and may trip because of the overvoltage caused by the energy regenerated by the motor.
- If this function operates during acceleration and the output frequency cannot reach the target frequency, try to make the following adjustments:
- Increase the acceleration time. (See Section 4.2.8.)
 - Increase the torque boost setting. (See Section 4.2.19.)
 - Increase the overload restriction setting (b022/b025).

Related code
b021: Overload restriction operation mode
b022: Overload restriction setting
b023: Deceleration rate at overload restriction
b024: Overload restriction operation mode (2)
b025: Overload restriction setting (2)
b026: Deceleration rate at overload restriction (2)
C001 to C008: Terminal [1] to [8] functions
C021 to C025: Terminal [11] to [15] functions
C026: Alarm relay terminal function
C040: Overload signal output mode
C041: Overload level setting
C111: Overload setting (2)

Item	Function code	Data or range of data	Description
Overload restriction operation mode	b021/b024	00	Disabling the overload restriction
		01	Enabling the overload restriction during acceleration and constant-speed operation
		02	Enabling the overload restriction during constant-speed operation
		03	Enabling the overload restriction during acceleration and constant-speed operation (increasing the frequency during regenerative operation)
Overload restriction setting	b022/b025	CT mode 0.20 to 2.00 x rated current <0.20 to 1.80 x rated current> VT mode 0.20 to 1.50 x rated current <0.20 to 1.50 x rated current>	Current at which to trigger the overload restriction
Deceleration rate at overload restriction	b023/b026	0.1 to 30.0 (s)	Deceleration time to be applied when the overload restriction operates
Terminal function	C001 to C008	39	Terminal to switch the overload restriction setting

(NOTE) <>: applied for 75 to 150kW

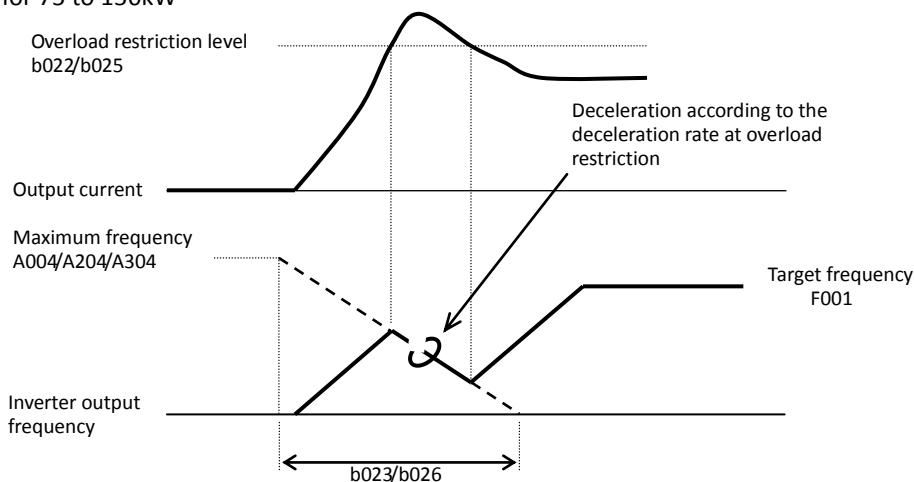

(2) Overload notice function

The overload notice function allows you to make the inverter output an overload notice signal before tripping because of overload.

You can use this function effectively to prevent the machine (e.g., a conveyor) driven by the inverter from being overloaded and prevent the conveyor from being stopped by the overload protection of the inverter.

To use this function, assign function "03" (OK) or "26" (OL2) to one of the intelligent output terminals [11] to [15] (C021 to C025) and the alarm relay terminal (C026). (Two types of overload notice signal are available for output.)

Item	Function code	Data or range of data	Description
Overload signal output mode	C040	00	Enabling the warning output during acceleration, deceleration, and constant
		01	Enabling the warning output during constant
Overload level setting	C041	0.0	Disabling the warning output
		CT mode 0.00 to 2.00 x rated current <0.00 to 1.80 x rated current> VT mode 0.00 to 1.50 x rated current <0.00 to 1.50 x rated current>	Specifying the current at which to output the OL signal (overload notice advance signal (1))
Overload setting (2)	C111	0.0	Disabling the warning output
		CT mode 0.00 to 2.00 x rated current <0.00 to 1.80 x rated current> VT mode 0.00 to 1.50 x rated current <0.00 to 1.50 x rated current>	Specifying the current at which to output the OL2 signal (overload notice advance signal (2))

(NOTE) <>:applied for 75 to 150kW

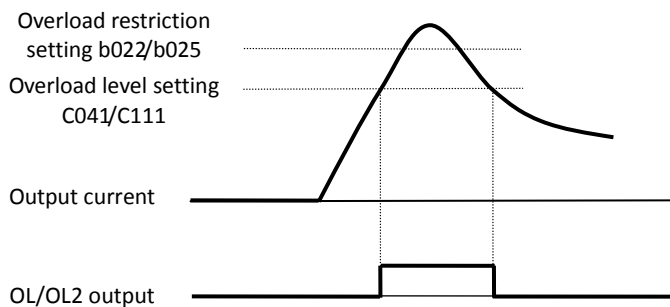

4.2.31 Overcurrent restraint

The overcurrent restraint function allows you to restrain the overcurrent that can occur when the output current sharply increases because of rapid acceleration.

You can enable or disable the function by setting the overcurrent suppression enable (b027).

Related code
b027: Overcurrent suppression enable

Item	Function code	Data or range of data	Description
Overcurrent suppression enable	b027	00	Disabling the overcurrent restraint
		01	Enabling the overcurrent restraint

Note: When using the inverter for a lift, disable the overcurrent restraint function. If the overcurrent restraint functions during the lift operation, the lift may slide down because of insufficient torque.

4.2.32 Over voltage suppression during deceleration

- The over voltage suppression function allows you to prevent the inverter from tripping because of the overvoltage that can be caused by the energy regenerated by the motor during deceleration.
- You can enable or disable the function by setting the overvoltage suppression enable (b130).
- When "01" (enabling the over voltage suppression [with deceleration stop]) is specified for the overvoltage suppression enable (b130), the inverter will decelerate by keeping the voltage of the main circuit DC section at over voltage suppression level (b131).
- When "02" (enabling the overvoltage suppression [with acceleration]) is specified for the overvoltage suppression enable (b130), the inverter will start acceleration according to the acceleration and deceleration rate at overvoltage suppression (b132) if the voltage of the main circuit DC section exceeds the overvoltage suppression level (b131). Subsequently, the inverter will restart deceleration when the voltage falls below the level (b131).

Related code

b130: Overvoltage suppression enable
 b131: Overvoltage suppression level
 b132: Acceleration and deceleration rate at overvoltage suppression

Item	Function code	Data or range of data	Description
Overvoltage suppression enable	b130	00	Disable
		01	Enabling the overvoltage suppression (with controlled deceleration) (See example 1.) (note5)
		02	Enabling the overvoltage suppression (with acceleration) (See example 2.)
		03	Enabling the overvoltage suppression (with acceleration and constant speed) (See example 2.)
Overvoltage suppression level (See Note 4.)	b131	330 to 390 (V)	Level setting for 200 V class models
		660 to 780 (V)	Level setting for 400 V class models
Acceleration rate at overvoltage suppression	b132	0.10 to 30.00 (s)	Specifying the acceleration rate to be applied when the function is enabled
Overvoltage suppression proportional gain	b134	0 to 255	Overvoltage suppression proportional gain setting (valid when b130=01)
Overvoltage suppression integral time	b135	0 to 65535	Overvoltage suppression integral time setting (valid when b130=01)

(Example 1) When "b130" is "01":

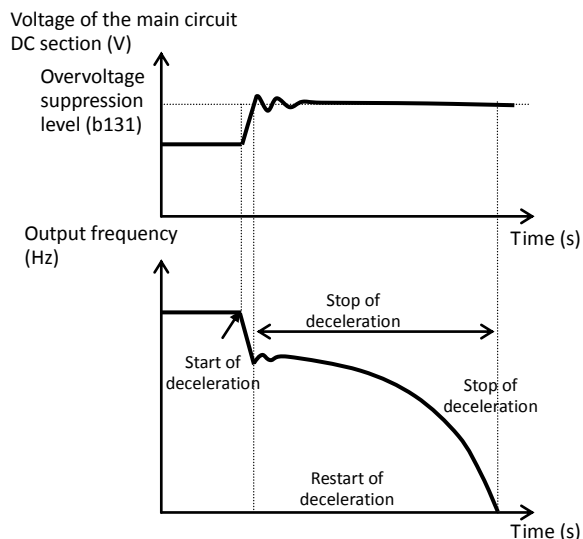

(Example 2) When "b130" is "02" and "03":

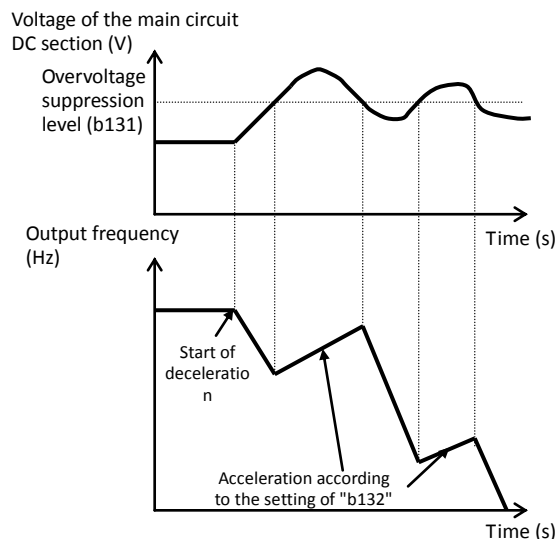

Note 1: When this function is enabled, the actual acceleration time may be prolonged over the set time.

Note particularly that the motor may not be decelerated if the setting of "b131" is too small when "02" is specified for the overvoltage suppression enable (b130).

Note 2: This overcurrent restraint function does not maintain the DC voltage at a constant level. Therefore, inverter tripping due to overvoltage may be caused by the setting of the deceleration rate or by a specific load condition.

Note 3: When this function is enabled, the inverter may require a long time to decelerate and stop the motor if the load on the motor or the moment of inertia on the motor is under a specific condition.

Note 4: If a voltage lower than the input voltage is specified for b131, the motor cannot be stopped.

Note 5: When "01" is specified for b130, PI control is performed so that internal DC voltage is maintained at a constant level.

- Setting a higher proportional gain (b133) results in a faster response. However, an excessively high proportional gain causes control to diverge and results in the inverter easily tripping.

- Setting a shorter integral time (b134) results in a faster response. However, an excessively short integral time results in the inverter easily tripping.

4.2.33 Start frequency setting

The start frequency setting function allows you to specify the inverter output frequency that the inverter initially outputs when an operation command is input.

Related code
b082: Start frequency adjustment

Use this function mainly to adjust the start torque.

If the start frequency (b082) is set too high, the inverter will start the motor with a full voltage, which will increase the start current. Such status may trigger the overload restriction operation or make the inverter prone to easily tripping because of the overcurrent protection.

Specifying "04" (OSLV: 0Hz-range sensorless vector control) or "05" (V2: vector control with sensor) for the V/F characteristic curve selection (A044) disables the start frequency setting function.

Item	Function code	Range of data	Description
Start frequency adjustment	b082	0.10 to 9.99 (Hz)	Setting of the start frequency

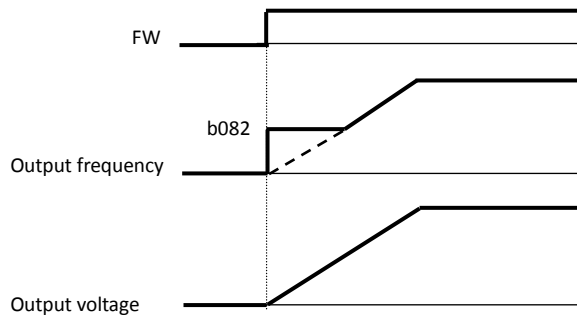

4.2.34 Reduced voltage start function

The reduced voltage start function enables you to make the inverter increase the output voltage gradually when starting the motor.

Related code
b036: Reduced voltage start selection
b082: Start frequency adjustment

Set a small value for the reduced voltage start selection (b036) if you intend to increase the start torque. On the other hand, setting a small value will cause the inverter to perform full-voltage starting and to easily trip because of overcurrent.

Item	Function code	Range of data	Description
Reduced voltage start selection	b036	00	Disabling the reduced voltage starting
		01 to 255	01: Short (about 6 ms) ↕ 255: Long (about 1.53 s)

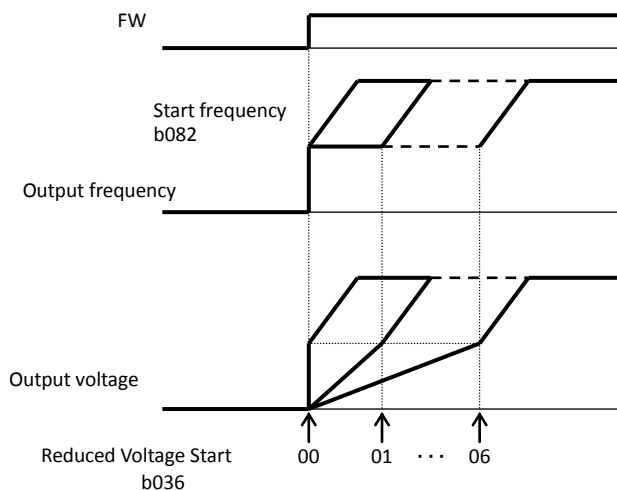

4.2.35 Carrier frequency setting

Related code
b083: Carrier frequency setting

The carrier frequency setting function (b083) allows you to change the carrier frequency of the PWM waveform output from the inverter.

Increasing the carrier frequency can lower the metallic noise from the motor, but may increase the inverter noise and current leakage.

You can use this function effectively to avoid resonance of the mechanical system and motor.

Item	Function code	Range of data	Description
Carrier frequency setting	b083	CT mode : 0.5 to 15.0 (kHz) <0.5 to 10.0(kHz)> VT mode : 0.5 to 12.0 (kHz) <0.5 to 8.0(kHz)>	(*1)(*2)

- *1 The maximum carrier frequency varies depending on the inverter capacity. When increasing the carrier frequency (fc), derate the output current as shown in the following table: Derated output current is to be set as electronic thermal protection level (4.2.29). Derating is not needed when electronic thermal level is already set to lower than derating level.

*2 <>:applied for 75 to 150kW

Voltage class	200 V class				400 V class			
	CT mode		VT mode		CT mode		VT mode	
Inverter capacity	Maximum fc (kHz)	Derating at fc=15 kHz	Maximum fc (kHz)	Derating at fc=15 kHz	Maximum fc (kHz)	Maximum fc (kHz)	Maximum fc (kHz)	Maximum fc (kHz)
0.4kW	15	100%	12	100%	-	-	-	-
0.75kW	15	100%	12	100%	15	100%	12	100%
1.5kW	15	100%	12	100%	15	100%	12	100%
2.2kW	15	100%	12	100%	15	100%	12	100%
3.7kW (4.0kW)	15	100%	6	90%(17.6A or less)	15	100%	10	90%(9.9A 以下)
5.5kW	15	100%	12	100%	15	100%	12	100%
7.5kW	15	100%	12	100%	15	100%	12	100%
11kW	12	90%(41.4A or less)	7	90%(52.2A or less)	15	100%	12	100%
15kW	12	95%(60.8A or less)	8	90%(65.7A or less)	14	95%(30.4A or less)	12	100%
18.5kW	10	90%(68.4A or less)	6	90%(76.5A or less)	10	90%(34.2A or less)	8	95%(40.8A or less)
22kW	7	70%(66.5A or less)	5	90%(101.7A or less)	6	75%(36.0A or less)	8	90%(51.3A or less)
30kW	5	80%(96.8A or less)	8	80%(112.0A or less)	10	75%(43.5A or less)	10	80%(56.0A or less)
37kW	10	75%(108.7A or less)	3	75%(126.7A or less)	8	80%(60.0A or less)	9	90%(76.5A or less)
45kW	5	70%(127.4A or less)	8	90%(189.0A or less)	9	75%(68.2A or less)	8	80%(84.0A or less)
55kW	5	70%(154.0A or less)	3	90%(243A or less)	6	60%(67.2A or less)	6	75%(101.2A or less)
75kW	-	-	-	-	6	85%(126.7A or less)	7	90%(144.0A or less)
90kW	-	-	-	-	4	75%(132.0A or less)	3	80%(156.0A or less)
110kW	-	-	-	-	6	70%(151.9A or less)	4	85%(195.5A or less)
132kW (150kW)	-	-	-	-	3	60%(156.0A or less)	3	70%(203.0A or less)

- CT mode

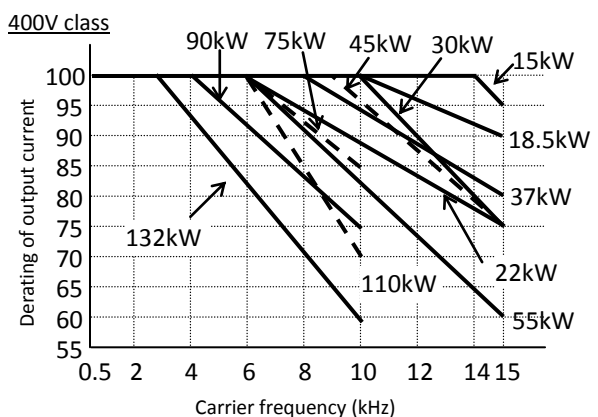
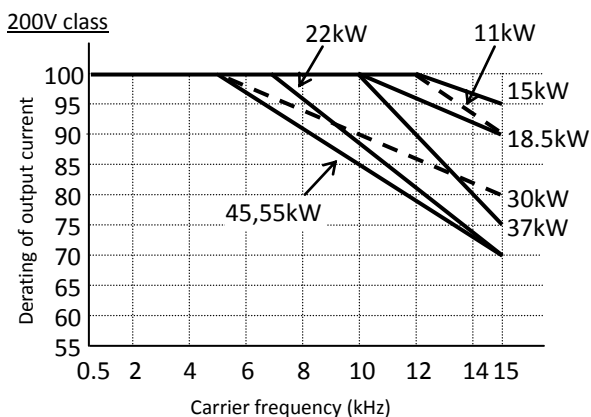

- VT mode

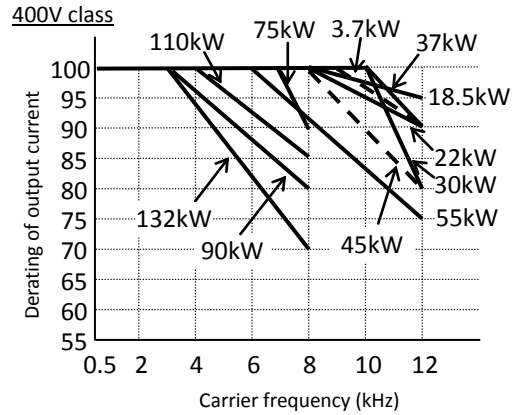
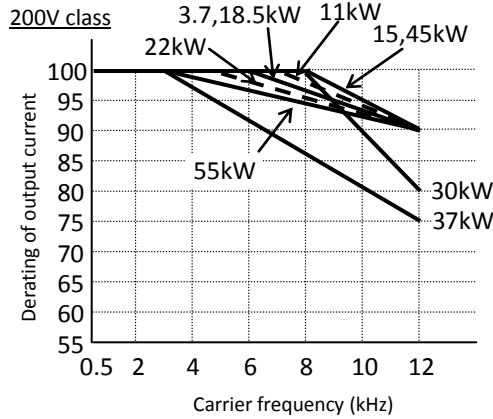

(NOTE) In case of replacing with SJ300 combined with LCR filter, please check the type code of LCR filter and consult for compatibility (75-150kW).

4.2.36 Automatic carrier frequency reduction

- The automatic carrier frequency reduction function automatically reduces the carrier frequency according to the increase in output current.
- To enable this function, specify "01" for automatic carrier frequency reduction selection (b089).

Related code
 b089: Automatic carrier frequency reduction selection
 b083: Carrier frequency setting

Item	Function code	Range of data	Description
Automatic carrier frequency reduction	b089	00/01	00: invalid, 01: valid

- When the output current increases to the current level described below, this function reduces the carrier frequency, respectively. This function restores the original carrier frequency when the output current decreases to 5% lower than each reduction start level.

Carrier frequency reduction start level (Restoration level)	0.4 to 55kW(CT mode)	75 to 150kW(CT mode) 0.4 to 55kW(VT mode)	75 to 150kW(VT mode)
	Carrier frequency after reduction (kHz)		
Less than 60% of rated current	15.0	10.0	6.0
60% (55%) of rated current	12.0	8.0	5.0
72% (67%) of rated current	9.0	6.0	4.0
84% (79%) of rated current	6.0	4.5	3.0
96% (91%) of rated current	3.0	3.0	2.5

(Example) 0.4 to 55kW(CT mode)

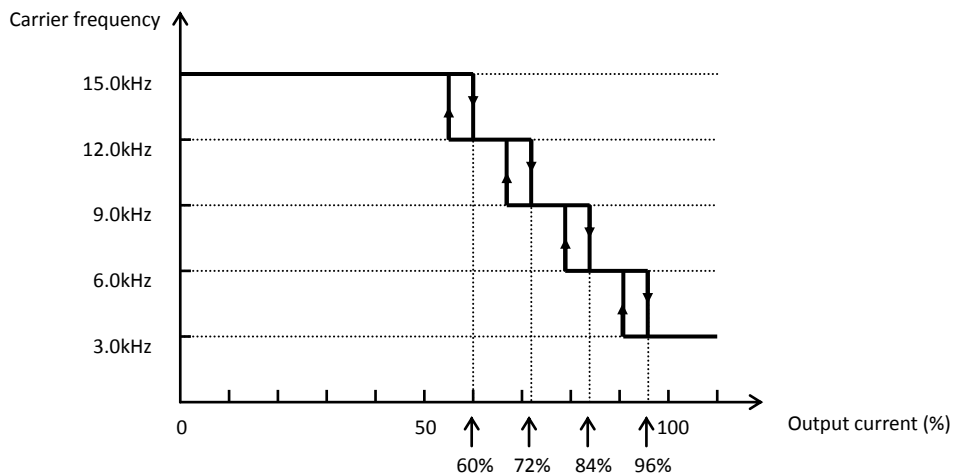

- The rate of carrier frequency reduction is 2 kHz per second.
- The maximum limit of carrier frequency change by this function is the value specified for the carrier frequency setting (b083); the minimum limit is 3 kHz.

Note: If 3 kHz or less frequency has been specified for b083, this function is disabled regardless of the setting of b089.

4.2.37 Dynamic braking (BRD) function

The dynamic braking (BRD) function is provided in the SJ700-220LFF/HFF and other models that have the built-in BRD circuit.

With this function, the energy regenerated by the motor is consumed by an external resistor (i.e., the energy is converted to heat). You can effectively use this function in your system, for example, to operate the motor as a generator by rapidly decelerating the motor.

To use this function, make the following settings:

Related code

b090: Dynamic braking usage ratio
b095: Dynamic braking control
b096: Dynamic braking activation level

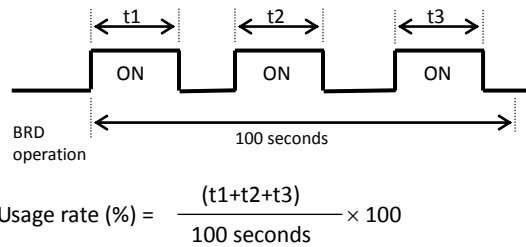
Item	Function code	Data or range of data	Description
Dynamic braking usage ratio	b090 (*2)	0.0	Disabling the BRD operation
		0.1 to 100.0 (%)	Setting of the dynamic braking usage ratio in units of 0.1% The inverter will trip when the set rate is exceeded.  $\text{Usage rate (\%)} = \frac{(t1+t2+t3)}{100 \text{ seconds}} \times 100$
Dynamic braking control	b095	00	Disabling the BRD operation
		01	Enabling the BRD operation while the motor is running Disabling the BRD operation while the motor is stopped
		02	Enabling the BRD operation regardless of whether the motor is running
Dynamic braking activation level	b096	330 to 380 (V) (*1)	Level setting for 200 V class models
		660 to 760 (V) (*1)	Level setting for 400 V class models

*1 The set dynamic braking activation level specifies the DC output voltage of the inverter's internal converter.

*2 Please refer P2-22 for minimum resistance of connectable resistor and BRD ratio (2.2.5).

4.2.38 Cooling-fan operation setting

The cooling-fan operation setting function allows you to specify the operation mode of the inverter's internal cooling fan. The cooling fan can be operated on a constant basis or only while the inverter is driving the motor.

Related code

b092: Cooling fan control

Item	Function code	Data or range of data	Description
Cooling fan control	b092	00	Specifying that the fan operates on a constant basis
		01	Specifying that the fan operates only while the inverter is driving the motor. Note that the fan operates for 5 minutes after the inverter power is turned on and after the inverter is stopped.

Note: The cooling fan stops automatically when instantaneous power failure occurs or the inverter power is shut off and resume the operation after power recovered.

4.2.39 Intelligent input terminal setting

You can assign the functions described below to intelligent input terminals [1] to [8]. To assign the desired functions to the terminals, specify the desired data listed in the table below for terminal settings "C001" to "C008". For example, "C001" corresponds to intelligent input terminal [1].

You can select the a-contact or b-contact input for individual intelligent input terminals.

You can assign one function only to an intelligent input terminal. If you have attempted to assign a function to two or more intelligent input terminals, the function is assigned to only the terminal to which you have last attempted assignment. Function data "NO" (no assign) is assigned to other terminals, and those terminals are ineffective in terms of functions.

After assigning the desired functions to intelligent input terminals [1] to [8], confirm that the assigned functions have been stored on the inverter.

Related code
C001 to C008: Terminal [1] to [8] functions

Function code	Data	Description	Reference item	Page
C001 to C008	01	RV: Reverse RUN command	Operation command	—
	02	CF1: Multispeed 1 setting (binary operation)	Multispeed operation function	4-48
	03	CF2: Multispeed 2 setting (binary operation)		
	04	CF3: Multispeed 3 setting (binary operation)		
	05	CF4: Multispeed 4 setting (binary operation)		
	06	JG: Jogging	Jogging operation function	4-50
	07	DB: External DC braking	DC braking (external DC braking) function	4-20
	08	SET: Set 2nd motor data	2nd/3rd motor control function	4-50
	09	2CH: 2-stage acceleration/deceleration	2-stage acceleration/deceleration function	4-30
	11	FRS: Free-run stop	Free-run stop function	4-53
	12	EXT: External trip	External trip function	4-58
	13	USP: Unattended start protection	Unattended start protection function	4-57
	14	CS: Commercial power source enable	Commercial power supply switching function	4-54
	15	SFT: Software lock (control circuit terminal block)	Software lock function	4-52
	16	AT: Analog input voltage/current select	External analog input setting function	4-12
	17	SET3: 3rd motor control	2nd/3rd motor control function	4-51
	18	RS: Reset	Reset	4-55
	20	STA: Starting by 3-wire input	3-wire input function	4-58
	21	STP: Stopping by 3-wire input		
	22	F/R: Forward/reverse switching by 3-wire input		
	23	PID: PID disable	PID function	4-26
	24	PIDC: PID reset		
	26	CAS: Control gain setting	Control gain switching function	4-59
	27	UP: Remote control UP function	Remote control (UP/DWN) function	4-57
	28	DWN: Remote control DOWN function		
	29	DWN: Remote control data clearing		
	31	OPE: Forcible operation	Forcible-operation function	4-52
	32	SF1: Multispeed 1 setting (bit operation)	Multispeed operation function	4-48
	33	SF2: Multispeed 2 setting (bit operation)		
	34	SF3: Multispeed 3 setting (bit operation)		
	35	SF4: Multispeed 4 setting (bit operation)		
	36	SF5: Multispeed 5 setting (bit operation)		
	37	SF6: Multispeed 6 setting (bit operation)		
	38	SF7: Multispeed 7 setting (bit operation)		
	39	OLR: Overload restriction selection	Overload restriction function	4-40
	40	TL: Torque limit enable	Torque limitation function	4-93
	41	TRQ1: Torque limit selection bit 1		
	42	TRQ2: Torque limit selection bit 2		
	43	PPI: P/PI mode selection	P/PI switching function	4-59
	44	BOK: Braking confirmation	Brake control function	4-82
	45	ORT: Orientation	Orientation function	4-105
	46	LAC: LAD cancellation	LAD cancellation function	4-10
	47	PCLR: Clearance of position deviation	V2 control mode selection function	4-97
	48	STAT: Pulse train position command input enable		
	50	ADD: Trigger for frequency addition (A145)	Frequency addition function	4-14

Function code	Data	Description	Reference item	Page
C001 to C008	51	F-TM: Forcible-terminal operation	Forcible-terminal operation function	4-52
	52	ATR: Permission of torque command input	Torque control function	4-99
	53	KHC: Cumulative power clearance	Cumulative power monitoring function	4-4
	54	SON: Servo On	Servo on function	4-112
	55	FOC: Forcing	forcing function	4-92
	56	MI1: General-purpose input 1	Easy sequence function (*1)	-
	57	MI2: General-purpose input 2		
	58	MI3: General-purpose input 3		
	59	MI4: General-purpose input 4		
	60	MI5: General-purpose input 5		
	61	MI6: General-purpose input 6		
	62	MI7: General-purpose input 7		
	63	MI8: General-purpose input 8		
	65	AHD: Analog command holding	Analog command holding function	4-60
	66	CP1: multistage position settings selection 1	Absolute position control mode	4-109
	67	CP2: multistage position settings selection 2		
	68	CP3: multistage position settings selection 3		
	69	ORL: Zero-return limit function		
	70	ORG: Zero-return trigger function		
	71	FOT: forward drive stop		
	72	ROT: reverse drive stop		
73	SPD: speed / position switching			
74	PCNT: pulse counter	Intelligent pulse counter	4-60	
75	PCC: pulse counter clear			
82	PRG: EzSQ program run	Easy sequence function (*1)	-	
no	NO : no function			

(*1) Refer to programming software EZ-SQ user manual.

4.2.40 Input terminal a/b (NO/NC) selection

The input terminal a/b (NO/NC) selection function allows you to specify a-contact or b-contact input for each of the intelligent input terminals [1] to [8] and the FW terminal.

An a-contact turns on the input signal when closed and turns it off when opened.

An b-contact turns on the input signal when opened and turns it off when closed.

The terminal to which the reset (RS) function is assigned functions only as an a-contact.

Related code
 C011 to C018: Terminal [1] to [8] active state
 C019: Terminal [FW] active state

Item	Function code	Data	Description
Terminal active state	C011 to C018	00	a-contact (NO)
		01	b-contact (NC)
Terminal [FW] active state	C019	00	a-contact (NO)
		01	b-contact (NC)

4.2.41 Multispeed select setting (CF1 to CF4 and SF1 to SF7)

The multispeed select setting function allows you to set multiple motor speeds and switch among them by way of signal input via specified terminals.

Multispeed operation can be performed in two modes: binary operation mode (with up to 16 speeds) using four input terminals and bit operation mode (with up to eight speeds) using seven input terminals.

Related code
 A019: Multispeed operation selection
 A020/A220/A320: Multispeed frequency setting, 1st/2nd/3rd motors
 A021 to A035: Multispeed 1 to 15 settings
 C001 to C008: Terminal [1] to [8] functions
 C169: Multistage speed/position determination time

Item	Function code	Data	Description
Multispeed operation selection	A019	00	Binary operation mode with up to 16 speeds
		01	Bit operation mode with up to 8 speeds
Multispeed 0 to 15 settings	A020/A220/ A320 A021 to A035	0.00 or "start frequency" to "maximum frequency" (Hz)	Setting of the frequency as each speed

Carefully note that during multispeed operation, the rotation direction specified in an operation command is reversed if the sum of the frequencies specified by the main frequency and auxiliary frequency commands is less than 0 Hz when the following settings have been made:

- The control circuit terminal block (01) is specified for the frequency source setting (A001).
- The external analog input (O/O2/OI) mode, set by a combination of [AT] selection (A005), [O2] selection (A006), and AT terminal On/Off state allows reversible motor operation.

(1) Binary operation mode

Assign functions "02" (CF1) to "05" (CF4) individually to the terminal [1] to [8] functions (C001 to C008) to make multispeeds 0 to 15 available for selection.

Specify the desired frequencies for speeds 1 to 15 by setting multispeeds 1 to 15 (A021 to A035).

You can set speed 0 by using function "A020", "A220", "A320", or "F001" (see Section 4.2.1) when you have specified the digital operator for the frequency source setting. You can set speed 0 by using the O, OI, or O2 terminal when you have specified the control circuit board for the frequency source setting.

Multispeed	CF4	CF3	CF2	CF1
Speed 0	OFF	OFF	OFF	OFF
Speed 1	OFF	OFF	OFF	ON
Speed 2	OFF	OFF	ON	OFF
Speed 3	OFF	OFF	ON	ON
Speed 4	OFF	ON	OFF	OFF
Speed 5	OFF	ON	OFF	ON
Speed 6	OFF	ON	ON	OFF
Speed 7	OFF	ON	ON	ON
Speed 8	ON	OFF	OFF	OFF
Speed 9	ON	OFF	OFF	ON
Speed 10	ON	OFF	ON	OFF
Speed 11	ON	OFF	ON	ON
Speed 12	ON	ON	OFF	OFF
Speed 13	ON	ON	OFF	ON
Speed 14	ON	ON	ON	OFF
Speed 15	ON	ON	ON	ON

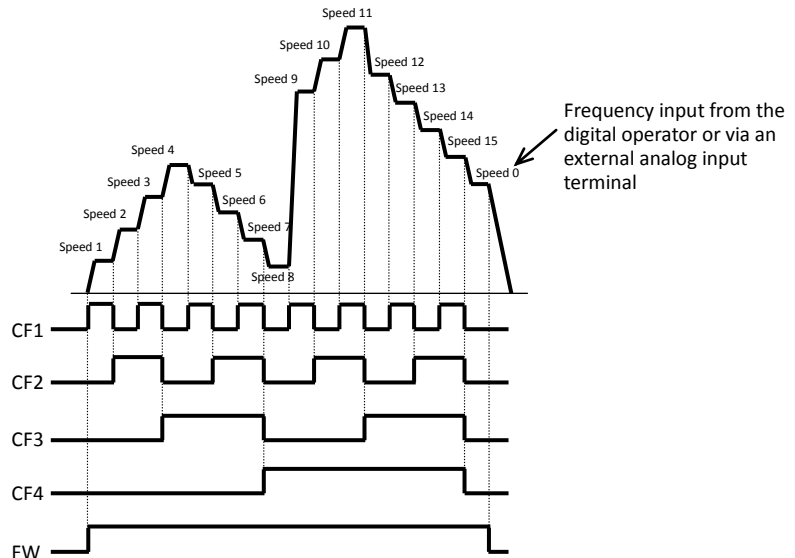

- With multispeed binary operation mode, you can use the multistage speed/position determination time setting (C169) to specify a delay to be set until the relevant terminal input is determined. Use this specification to prevent the application of fluctuating terminal input before it is determined.

- The input data is finally determined when terminal input becomes stable after the delay set as C169.

(Note that a long determination time deteriorates the input terminal response.)

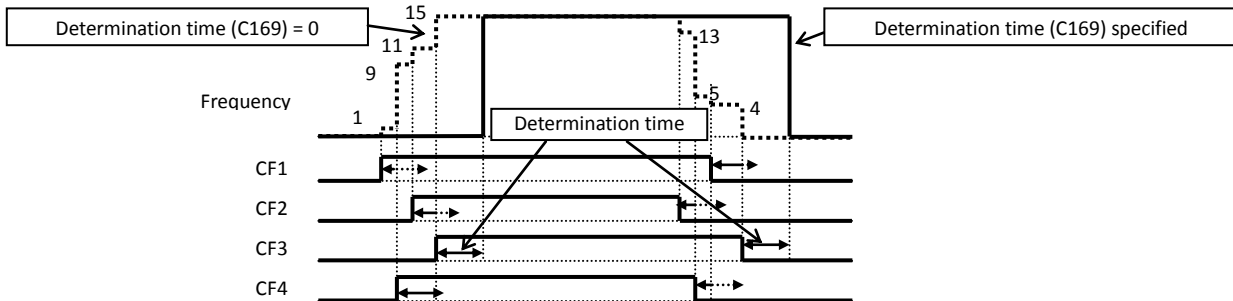

(2) Bit operation mode

- Assign functions "32" (SF1) to "38" (SF7) individually to the terminal [1] to [8] functions (C001 to C008) to make multispeeds 0 to 7 available for selection.

- Specify the desired frequencies for speeds 1 to 7 (SF1 to SF7) by setting multispeeds 1 to 7 (A021 to A027).

Multispeed	SF7	SF6	SF5	SF4	SF3	SF2	SF1
Speed 0	OFF	OFF	OFF	OFF	OFF	OFF	OFF
Speed 1	x	x	x	x	x	x	ON
Speed 2	x	x	x	x	x	ON	OFF
Speed 3	x	x	x	x	ON	OFF	OFF
Speed 4	x	x	x	ON	OFF	OFF	OFF
Speed 5	x	x	ON	OFF	OFF	OFF	OFF
Speed 6	x	ON	OFF	OFF	OFF	OFF	OFF
Speed 7	ON	OFF	OFF	OFF	OFF	OFF	OFF

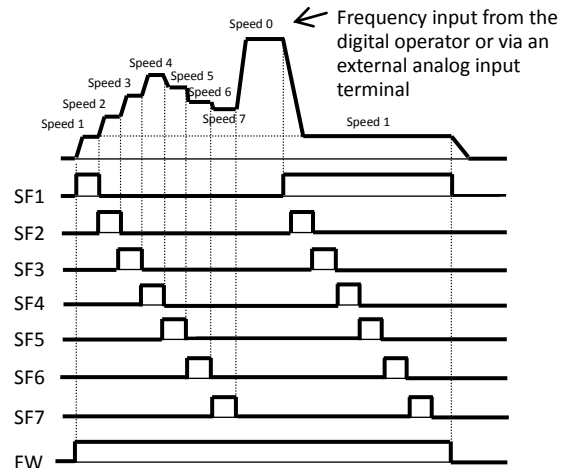

If two or more input terminals are turned on at the same time, the terminal given the smallest terminal number among them has priority over others. The "X" mark in the above table indicates that the speed can be selected, regardless of whether or not the corresponding terminal is turned on.

4.2.42 Jogging (JG) command setting

The jogging command setting function allows you to set and finely tune the motor-stopping position. To use this function, assign function "06" (JG) to an intelligent input terminal.

Related code
 A038: Jog frequency setting
 A039: Jog stop mode
 C001 to C008: Terminal [1] to [8] functions

(1) Jog frequency setting

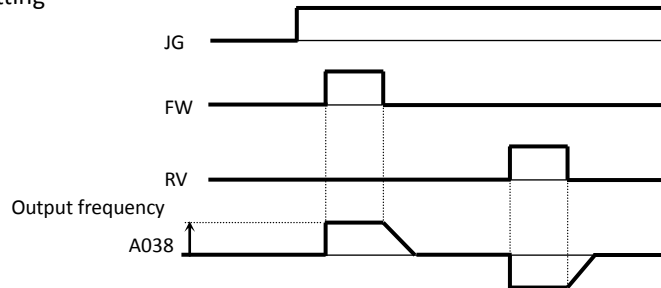

Since the inverter operates the motor with a full voltage for the jogging operation, the inverter can easily trip during the latter. Adjust the jog frequency setting (A038) properly so that the inverter will not trip.

Item	Function code	Range of data	Description
Jog frequency setting	A038	0.0 or "start frequency" to 9.99 (Hz)	Setting of the frequency to output during jogging operation

(2) Jog stop mode

Item	Function code	Data	Description
Jog stop mode	A039	00	Disabling jogging while the motor is operating and enabling free-running when the motor is stopped
		01	Disabling jogging while the motor is operating and enabling stopping after deceleration when the motor is stopped
		02 (See Note 2.)	Disabling jogging while the motor is operating and enabling DC braking when the motor is stopped
		03	Enabling jogging while the motor is operating and enabling free-running when the motor is stopped
		04	Enabling jogging while the motor is operating and enabling stopping after deceleration when the motor is stopped
		05 (See Note 2.)	Enabling jogging while the motor is operating and enabling DC braking when the motor is stopped

Note 1: To perform the jogging operation, always turn on the JG terminal before turning on the FW or RV terminals. (Follow this sequence of command inputs also when using the digital operator to enter operation commands.)

(Example 1)

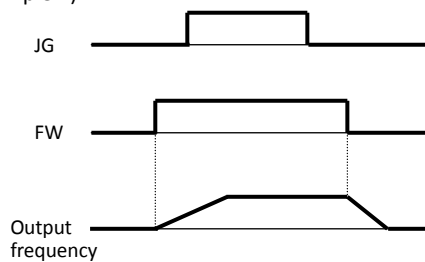

When "00", "01", or "02" is specified for the jog stop mode (A039), the jogging operation will not be performed if the FW signal is turned on earlier than the JG signal.

(Example 2)

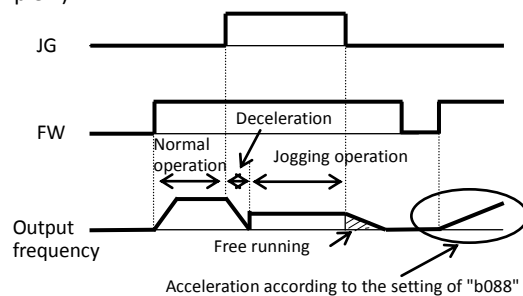

When "03", "04", or "05" is specified for the jog stop mode (A039), the jogging operation will be performed, even if the FW signal is turned on earlier than the JG signal. However, the motor will stop after free-running if the JG signal is turned off earlier than the FW signal.

Note 2: You must set DC braking data if you specify "02" or "05" for the jog stop mode (A039). (See Section 4.2.19.)

4.2.43 2nd/3rd motor control function (SET and SET3)

This motor control function allows you to switch the inverter settings to control three different types of motors. To use this function, assign function "08" (SET) and "17" (SET3) to two of the terminal [1] to [8] functions (C001 to C008). Turn the SET and SET3 terminals on and off for switching.

Item	Function code	Data	Description
Terminal function	C001 to C008	08	SET: Set 2nd motor data
		17	SET3: 3rd motor control

You can switch the following functional settings with the SET or SET3 terminal:

F002/F202/F302:	Acceleration (1) time setting, 1st/2nd/3rd motors
F003/F203/F303:	Deceleration (1) time setting, 1st/2nd/3rd motors
A003/A203/A303:	Base frequency setting, 1st/2nd/3rd motors
A004/A204/A304:	Maximum frequency setting, 1st/2nd/3rd motors
A020/A220/A320:	Multispeed frequency setting, 1st/2nd/3rd motors
A041/A241:	Torque boost method selection, 1st/2nd motors
A042/A242/A342:	Manual torque boost value, 1st/2nd/3rd motors
A043/A243/A343:	Manual torque boost frequency adjustment, 1st/2nd/3rd motors
A044/A244/A344:	V/F characteristic curve selection, 1st/2nd/3rd motors
A046/A246:	Voltage compensation gain setting for automatic torque boost, 1st/2nd motors
A047/A247:	Slippage compensation gain setting for automatic torque boost, 1st/2nd motors
A061/A261:	Frequency upper limit setting, 1st/2nd motors
A062/A262:	Frequency lower limit setting, 1st/2nd motors
A092/A292/A392:	Acceleration (2) time setting, 1st/2nd/3rd motors
A093/A293/A393:	Deceleration (2) time setting, 1st/2nd/3rd motors
A094/A294:	Select method to switch to Acc2/Dec2 profile, 1st/2nd motors
A095/A295:	Acc1 to Acc2 frequency transition point, 1st/2nd motors
A096/A296:	Dec1 to Dec2 frequency transition point, 1st/2nd motors
b012/b212/b312:	Electronic thermal setting (calculated within the inverter from current output), 1st/2nd/3rd motors
b013/b213/b313:	Electronic thermal characteristic, 1st/2nd/3rd motors
H002/H202:	Motor data selection, 1st/2nd motors
H003/H203:	Motor capacity, 1st/2nd motors
H004/H204:	Motor poles setting, 1st/2nd motors
H005/H205:	Motor speed constant, 1st/2nd motors
H006/H206/H306:	Motor stabilization constant, 1st/2nd/3rd motors
H020/H220:	Motor constant R1, 1st/2nd motors
H021/H221:	Motor constant R2, 1st/2nd motors
H022/H222:	Motor constant L, 1st/2nd motors
H023/H223:	Motor constant lo, 1st/2nd motors
H024/H224:	Motor constant J, 1st/2nd motors
H030/H230:	Auto constant R1, 1st/2nd motors
H031/H231:	Auto constant R2, 1st/2nd motors
H032/H232:	Auto constant L, 1st/2nd motors
H033/H233:	Auto constant lo, 1st/2nd motors
H034/H234:	Auto constant J, 1st/2nd motors
H050/H250:	PI proportional gain, 1st/2nd motors
H051/H251:	PI integral gain, 1st/2nd motors
H052/H252:	P proportional gain setting, 1st/2nd motors
H060/H260:	Zero LV limit, 1st/2nd motors

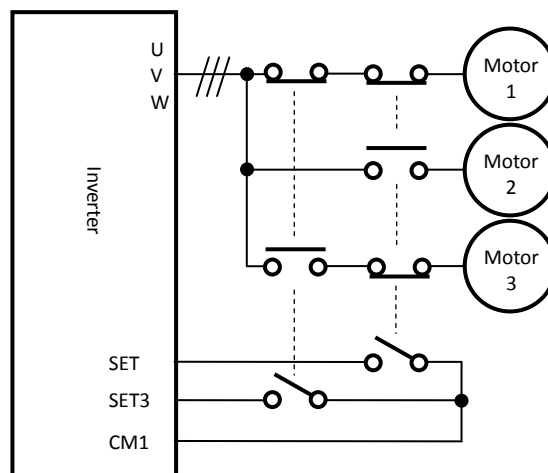

Since the inverter indicates no distinction among the 1st, 2nd, and 3rd controls, confirm the kind of control settings with the on/off states of the SET and SET3 terminals.

If both the SET and SET3 terminals are turned on, the SET terminal has priority, and the 2nd control is selected.

While the inverter is operating the motor, switching between the 1st, 2nd, and 3rd when motor stops controls is disabled. Switching the motor control is valid only when the motor is stopped, so change is reflected after the operation.

The above setting items printed in italic, bold type can be adjusted even while the inverter is operating the motor.

(Whether each item can be set during operation and whether it can be changed during operation are indicated in the list of data settings in Chapter 8.)

4.2.44 Software lock (SFT) function

The software lock function allows you to specify whether to disable rewriting of the data set for functional items. Use this function to protect the data against accidental rewriting.

You can select the functional items to be locked and the method of locking as described below.

When using an intelligent input terminal for this function, assign function "15" (SFT) to one of the terminal [1] to [8] functions (C001 to C008).

Related code

b031: Software lock mode selection
C001 to C008: Terminal [1] to [8] functions

Function code	Data	SFT terminal	Description
b031	00	ON/OFF	Disabling rewriting of items other than "b031" (when SFT is on) or enabling rewriting (when SFT is off)
	01	ON/OFF	Disabling the rewriting of items other than "b031", "F001", "A020", "A220", "A320", "A021" to "A035", and "A038" (when SFT is on) or enabling rewriting (when SFT is off)
	02	—	Disabling the rewriting of items other than "b031"
	03	—	Disabling the rewriting of items other than "b031", "F001", "A020", "A220", "A320", "A021" to "A035", and "A038"
	10	—	Disabling rewriting except in the mode allowing changes during operation

4.2.45 Forcible-operation from digital operator (OPE) function

The forcible-operation function allows you to forcibly enable the inverter operation from the digital operator when the digital operator is not selected as the device to input frequency and operation commands. An intelligent input terminal is used to turn this function on and off.

When the intelligent input terminal to which the forcible-operation function is assigned is off, frequency and operation commands are input from the devices selected by functions "A001" and "A002". When the terminal is on, the device to input frequency and operation commands is forcibly switched to the digital operator.

If the input device is switched while the inverter is operating, the current operation command is canceled and the inverter stops the output. When restarting the inverter operation, turn off the operation command that was to be entered from each input device for safety's sake, and then enter a new operation command.

Related code

A001: Frequency source setting
A002: Run command source setting
C001 to C008: Terminal [1] to [8] functions

Item	Function code	Data	Description
Terminal function	C001 to C008	31	OPE: Forcible operation

4.2.46 Forcible-operation from terminal (F-TM) function

The forcible-operation function allows you to forcibly enable the inverter operation via control circuit terminals when the control circuit terminal block is not selected as the device to input frequency and operation commands. An intelligent input terminal is used to turn this function on and off.

When the intelligent input terminal to which the forcible-terminal operation function is assigned is off, frequency and operation commands are input from the devices selected by functions "A001" and "A002". When the terminal is on, the device to input frequency and operation commands is forcibly switched to the control circuit terminal block.

If the input device is switched while the inverter is operating, the current operation command is canceled and the inverter stops the output. When restarting the inverter operation, turn off the operation command that was to be entered from each input device for safety's sake, and then enter a new operation command.

Related code

A001: Frequency source setting
A002: Run command source setting
C001 to C008: Terminal [1] to [8] functions

Item	Function code	Data	Description
Terminal function	C001 to C008	51	F-TM: Forcible-terminal operation

4.2.47 Free-run stop (FRS) function

The free-run stop (FRS) function allows you to shut off the inverter output to let the motor start free-running. You can effectively use this function when stopping the motor with a mechanical brake (e.g., electromagnetic brake). If an attempt is made to forcibly stop the motor with a mechanical brake while the inverter keeps its output, the inverter may trip because of overcurrent.

To use this function, assign function "11" (FRS) to one of the terminal [1] to [8] functions (C001 to C008). The free-run stop (FRS) function operates as long as the FRS terminal is on. When the FRS terminal is turned off, the inverter restarts the motor after the retry wait time (b003). However, the inverter does not restart the motor if the digital operator (02) has been specified for the run command source setting (A002). To restart the motor in such status, enter a new operation command.

You can select the inverter output mode for restarting with the restart mode after FRS (b088) from starting the motor with 0 Hz, starting the motor with a matching frequency, and restarting the motor with the input frequency. (See examples 1, 2, and 3.)

Even when restarting with matching frequency has been selected, the inverter restarts the motor with 0 Hz if it detects a frequency lower than the restart frequency threshold (b007).

The settings, including that of the FRS terminal, which you make for this function will affect the inverter operation at recovery of the motor from the free-running status.

Related code

b088: Restart mode after FRS
 b003: Retry wait time before motor restart
 b007: Restart frequency threshold
 b028: Active frequency matching, scan start frequency
 b029: Active frequency matching, scan-time constant
 b030: Active frequency matching, restart frequency select
 C001 to C008: Terminal [1] to [8] functions

Item	Function code	Data or range of data	Description
Restart mode after FRS	b088	00	Start with 0 Hz (See example 1.)
		01	Start with matching frequency (See example 2.)
		02	Restart with input frequency (See example 3.)
Retry wait time before motor restart	b003	0.3 to 100. (s)	Time to wait until restarting the motor
Restart frequency threshold	b007	0.00 to 400.0 (Hz)	Setting of the minimum level for frequency adjustment
Active frequency matching, scan start frequency	b028	CT mode 0.00 to 2.00 x rated current <0.00 to 1.80 x rated current> VT mode 0.00 to 1.50 x rated current <0.00 to 1.50 x rated current>	
Active frequency matching, scan-time constant	b029	0.10 to 30.00 (s)	
Active frequency matching, restart frequency select	b030	00	Frequency set when the inverter output has been shut off
		01	Maximum frequency
		02	Newly set frequency

(NOTE) <->: applied for 75 to 150kW

(Example 1) Restarting with 0 Hz

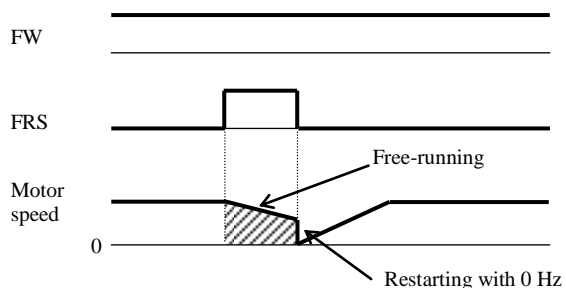

The inverter restarts the motor with 0 Hz regardless of the motor speed. The setting of retry wait time is ignored for restarting with 0 Hz. If the inverter restarts the motor with 0 Hz when the motor speed is high, the inverter may trip because of overcurrent.

(Example 2) Restarting with matching frequency

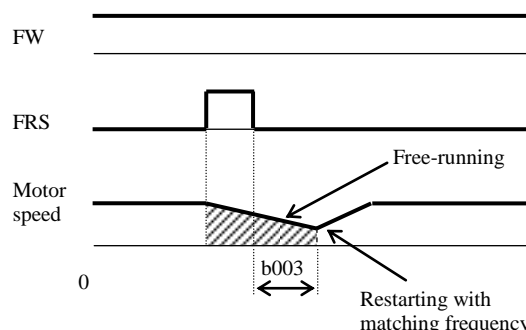

The inverter waits for the retry wait time after the FRS terminal has been turned off, detects the motor speed (frequency), and restarts the motor with the matching frequency without stopping it. If the inverter trips because of overcurrent when it restarts the motor with matching frequency, prolongs the retry wait time. Even when restarting with matching frequency has been selected, the inverter may start the motor with 0 Hz if:

- 1) the output frequency is no more than half the base frequency
- or
- 2) the voltage induced on the motor is attenuated quickly.

(Example 3) Restarting with active matching frequency

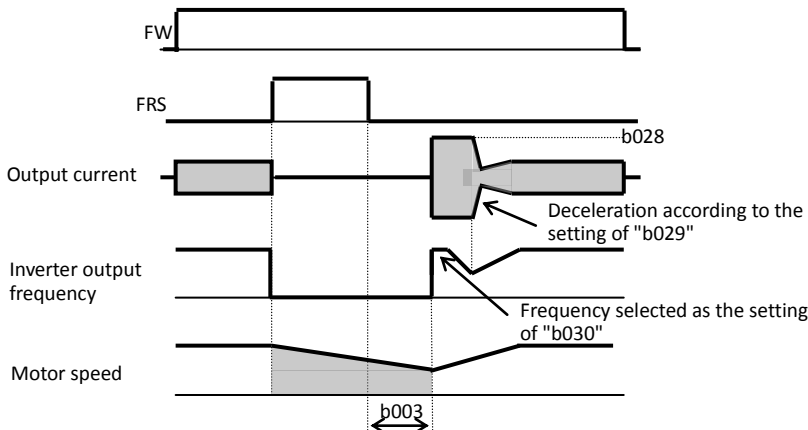

After the retry wait time (b003), the inverter restarts the motor with the frequency set as "b030". The inverter subsequently decelerates the motor according to the setting of "b029" while maintaining the output current at the level specified for "b029". When the output voltage matches the frequency, the inverter re-accelerates the motor up to the frequency that was set when the inverter shut off the output to the motor before the restart. If the inverter trips because of overcurrent when it restarts the motor with input frequency, reduce the setting of "b028".

4.2.48 Commercial power source switching (CS) function

The commercial power source switching function allows you to switch the power supply (between the inverter and commercial power supply) to your system of which the load causes a considerable moment of inertia. You can use the inverter to accelerate and decelerate the motor in the system and the commercial power supply to drive the motor for constant-speed operation.

To use this function, assign function "14" (CS) to one of the terminal [1] to [8] functions (C001 to C008). When the CS terminal is turned off with an operation command being input, the inverter waits for the retry wait time before motor restart (b003), adjusts the output frequency to the speed of the free-running motor, and then accelerates the motor with the adjusted frequency. (The start mode is the starting with matching frequency.) However, the inverter may start the motor with 0 Hz if:

- 1) the motor speed is no more than half the base frequency or
- 2) the voltage induced on the motor is attenuated quickly.
- 3) If the motor speed falls to the restart frequency threshold (b007), the inverter will start the motor with 0 Hz. (See Section 4.2.27.)

Related code
 b003: Retry wait time before motor restart
 b007: Restart frequency threshold
 C001 to C008: Terminal [1] to [8] functions

Remark) Mechanically interlock the MC3 and MC2 contacts with each other. Otherwise you may damage the drive. If the earth-leakage breaker (ELB) trips because of a ground fault, the commercial power will be disabled. Therefore, connect a backup power supply from the commercial power line circuit (ELBC) to your system if needed.

Use weak-current type relays for FWY, RVY, and CSY. The figures below show the sequence and timing of operations for reference.

If the inverter trips because of overcurrent when it starts the motor with matching frequency, increase the retry wait time before motor restart (b003).

For circuit connections and switching operations, see the sample connection diagram and timing charts for commercial power supply switching as shown on the right.

The inverter can be set up so that it will automatically retry operation at power-on. In such cases, the CS terminal (signal) shown in the figures below is not required. For details, see the explanation of the reset (RS) function (4.2.29).

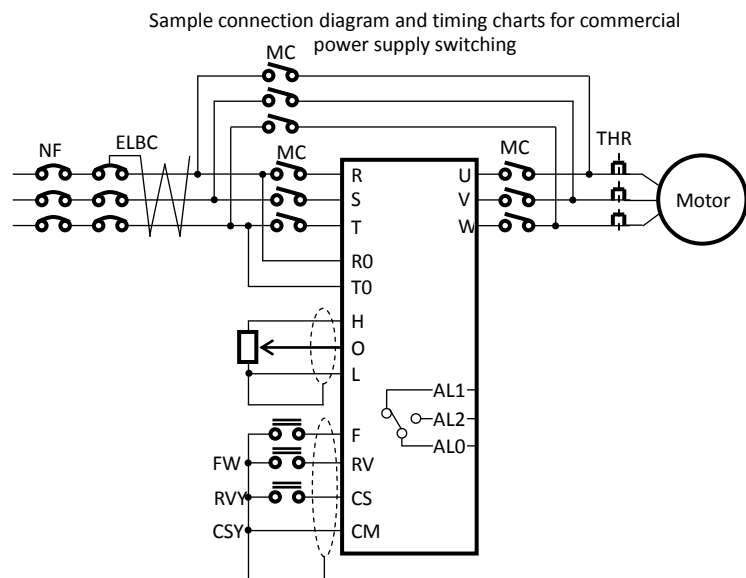

Timing chart for switching from the inverter to the commercial power supply

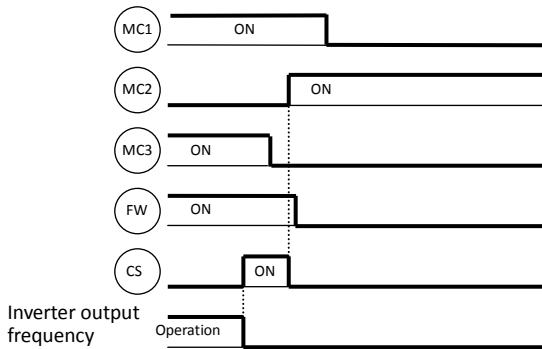

Timing chart for switching from the commercial power supply to the inverter

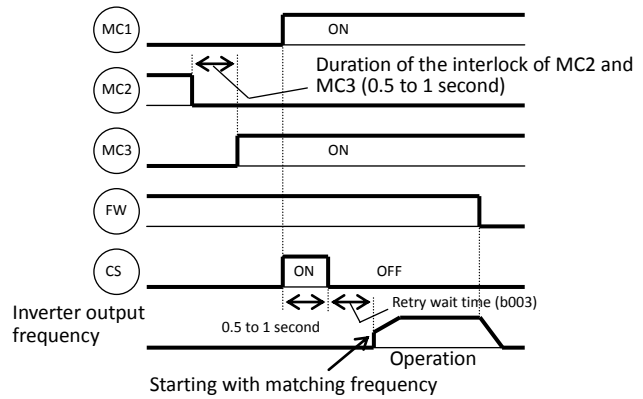

4.2.49 Reset (RS) function

The reset function allows you to recover the inverter from a tripped state. To perform resetting, press the STOP/RESET key of the digital operator or turn the RS terminal off.

To use the control circuit terminal for resetting, assign function "18" (RS) to an intelligent input terminal.

You can select the restart mode to apply after resetting with the restart mode after reset (C103). When C102 =03, starting with 0 Hz is selected regardless to C103 setting.

If the inverter trips because of overcurrent when it starts the motor with matching frequency, increase the retry wait time before motor restart (b003).

You can select the alarm reset timing with the reset mode selection (C102). You can also enable the reset signal to be output only when resetting an error alarm.

The RS terminal can be configured only as an a-contact (NO).

Do not use the RS terminal for the purpose of shutting off the inverter output. The reset operation clears the electronic thermal and BRD counter data stored in the inverter, and, without this data, the inverter may be damaged during operation.

Related code

- b003: Retry wait time before motor restart
- b007: Restart frequency threshold
- C102: Reset mode selection
- C103: Restart mode after reset
- C001 to C008: Terminal [1] to [8] functions

Item	Function code	Data or range of data	Description
Retry wait time before motor restart	b003	0.3 to 100. (s)	(See the explanations of the retry after instantaneous power failure or the retry after trip due to insufficient voltage.) Time to wait after reset until restarting the motor
Restart frequency threshold	b007	0.00 to 400.0 (Hz)	(See the explanations of the retry after instantaneous power failure or the retry after trip due to insufficient voltage.)
Reset mode selection	C102	00	Resetting the trip when the RS signal is turned on (See example 1.) (When operation is normal) Shutting off the inverter output (When an error has occurred) Resetting the trip
		01	Resetting the trip when the RS signal is turned off (See example 2.) (When operation is normal) Shutting off the inverter output (When an error has occurred) Resetting the trip
		02	Resetting the trip when the RS signal is turned on (See example 1.) (When operation is normal) Disabling the inverter output (When an error has occurred) Resetting the trip
		03	Trip is reset (See example 1) Internal data is not reset. (see 4.3.13) (When operation is normal) Disabling the inverter output (When an error has occurred) Resetting the trip
Restart mode after reset	C103	00	Start with 0 Hz
		01	Start with matching frequency (See example 3.)
		02	Restart with input frequency (See example 4.)

(Example 1)

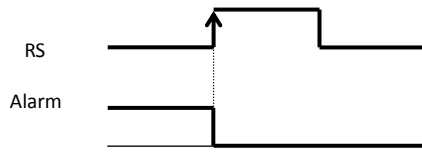

(Example 2)

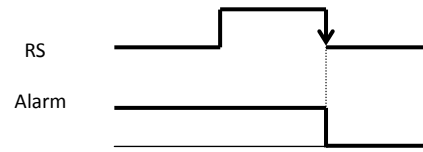

(Example 3) If you select "01" (starting with matching frequency) as the restart mode after reset (C103), you can also make the inverter start the motor with matching frequency after the power reset. When "00" (starting with 0 Hz) is selected as the restart mode after reset (C103), the setting of the retry wait time before motor restart (b003) is ignored. Note that, even when restarting with matching frequency has been selected, the inverter may start the motor with 0 Hz if:

- 1) the output frequency is no more than half the base frequency or
- 2) the voltage induced on the motor is attenuated quickly.
- 3) the restart frequency threshold (b007) is set and the detected frequency is lower than that.

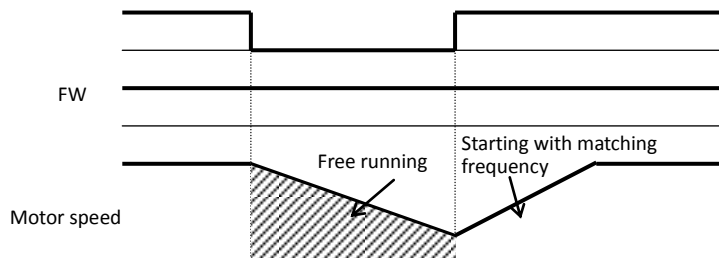

Note: The reset operation clears the inverter's internal counters that are used for protective functions. Therefore, if you intend to use an intelligent input terminal to shut off the inverter output, use the free-run stop (FRS) terminal.

(Example 4) Restarting with active matching frequency

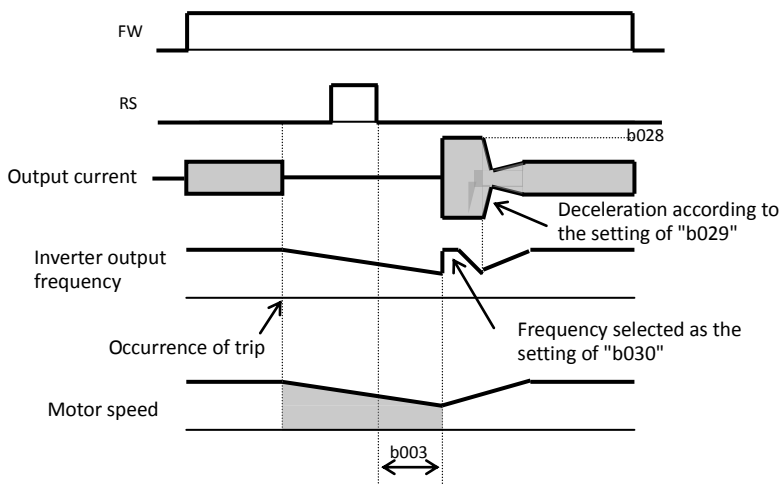

After the retry wait time (b003), the inverter restarts the motor with the frequency set as "b030". The inverter subsequently decelerates the motor according to the setting of "b029" while maintaining the output current at the level specified for "b029". When the output voltage matches the frequency, the inverter re-accelerates the motor up to the frequency that was set when the inverter shut off the output to the motor before the restart. If the inverter trips because of overcurrent when it restarts the motor with input frequency, reduce the setting of "b028".

(note) Inverter starts from 0Hz when reset signal is given during retry waiting because the frequency stored in inverter is cleared.

4.2.50 Unattended start protection (USP) function

Related code
C001 to C008: Terminal [1] to [8] functions

The unattended start protection function allows you to make the inverter trip with error code "E13" displayed if the inverter power is turned on when an operation command has been turned on.

You can recover the inverter from tripping by performing the reset operation or turning the operation command off. (See example 1.)

If the inverter is recovered from tripping with the operation command left turned on, the inverter will start operation immediately after recovery. (See example 2.)

The inverter can operate normally when an operation command is turned on after the inverter power is turned on. (See example 3.)

To use this function, assign function "13" (USP) to one of the terminal [1] to [8] functions (C001 to C008).

The following charts show examples of the timing of the unattended start protection operation:

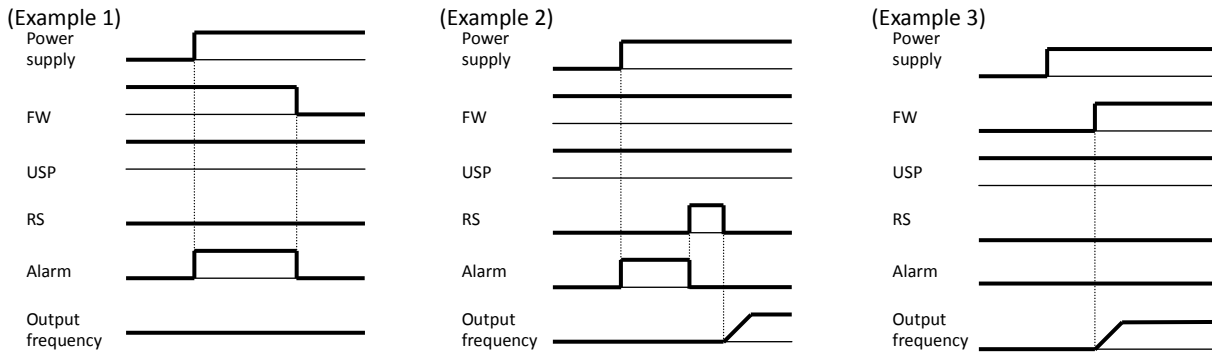

Item	Function code	Data	Description
Terminal [1] to [8] functions	C001 to C008	13	USP: Unattended start protection

4.2.51 Remote control function (UP and DWN)

Related code
C101: Up/Down memory mode selection
C001 to C008: Terminal [1] to [8] functions

The remote control function allows you to change the inverter output frequency by operating the UP and DWN terminals (intelligent input terminals).

To use this function, assign functions "27" (UP) and "28" (DWN) to two of the terminal [1] to [8] functions (C001 to C008).

- This function is only effective for multispeed operation when "01 (terminal)" or "02 (oprater)" has been specified for the frequency source setting (A001). If "01" (control circuit terminal block) has been specified, this function is only effective when the analog command holding function (AHD) is enabled. (see 4.2.56)

This function is ineffective when the external analog input has been specified for the frequency source setting (A001). This function cannot be used to set frequencies for jogging operation.

When the UP or DWN terminal is on, the 1st, 2nd, and 3rd acceleration/deceleration time follows the settings of "F002", "F003/F202", "F203/F302", and "F303". To switch between the 1st, 2nd, and 3rd controls, assign function "08" (SET) and "17" (SET3) to intelligent input terminals, and turn on and off the SET and SET3 terminals for switching.

You can store the frequency settings adjusted using the remote control function (UP and DWN signals). Set 01 (enable) on C101 to store the frequency settings.

You can also clear the stored frequency settings. Assign function "29" (UDC) to an intelligent input terminal, and turn on or off the UDC terminal to clear or store, respectively, the frequency settings adjusted with the UP and DWN signals. In this case 0Hz is set as initial value.

Item	Function code	Data	Description
Terminal function	C001 to C008	27	UP: Remote control UP function
		28	DWN: Remote control DOWN function
		29	DWN: Remote control data clearing
Up/Down memory mode selection	C101	00	Disabling the storage of frequency settings
		01	Enabling the storage of frequency settings (*1)

*1 Do not operate the UP or DWN terminal after the inverter power is shut off. Otherwise, the frequency settings may not be stored correctly.

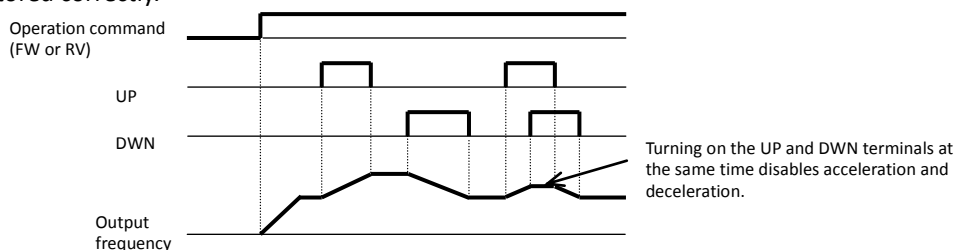

4.2.52 External trip (EXT) function

Related code
C001 to C008: Terminal [1] to [8] functions

The external trip function allows you to make the inverter trip according to the error (trip) signal generated by an external system.

To use this function, assign function "12" (EXT) to one of the terminal [1] to [8] functions (C001 to C008).

When the EXT terminal is turned on, the inverter trips with error code "E12" displayed and stops the output.

After the inverter trips with error code "E12" displayed, it will not be recovered from tripping, even when the error signal from the external system is reset (i.e., the EXT terminal is turned off).

To recover the inverter from tripping, reset the inverter or turn the inverter power off and on.

Item	Function code	Data	Description
Terminal [1] to [8] functions	C001 to C008	12	EXT: External trip

Note: Do not turn on the EXT terminal after the inverter power is shut off. Otherwise, the error history may not be stored correctly.

Operation commands FW and RV

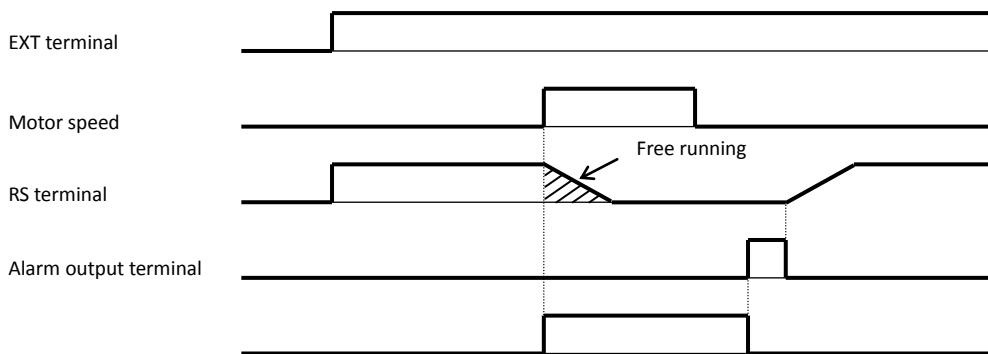

4.2.53 3-wire interface operation function (STA, STP, and F/R)

Related code
C001 to C008: Terminal [1] to [8] functions

The 3-wire interface operation function allows you to use automatic-reset contacts (e.g., pushbutton switches) to start and stop the inverter.

Specify "01" (control circuit terminal block) for the run command source setting (A002).

Assign function "20" (STA), "21" (STP), and "22" (F/R) to three of the terminal [1] to [8] functions (C001 to C008) to enable the control operations described below. Assigning the STP function to an intelligent input terminal disables the functions of the FW and RV terminals.

The figure below shows the inverter outputs according to terminal operations.

Item	Function code	Data	Description
Terminal [1] to [8] functions	C001 to C008	20	STA: Starting the motor
		21	STP: Stopping the motor
		22	F/R: Switching the motor operation direction

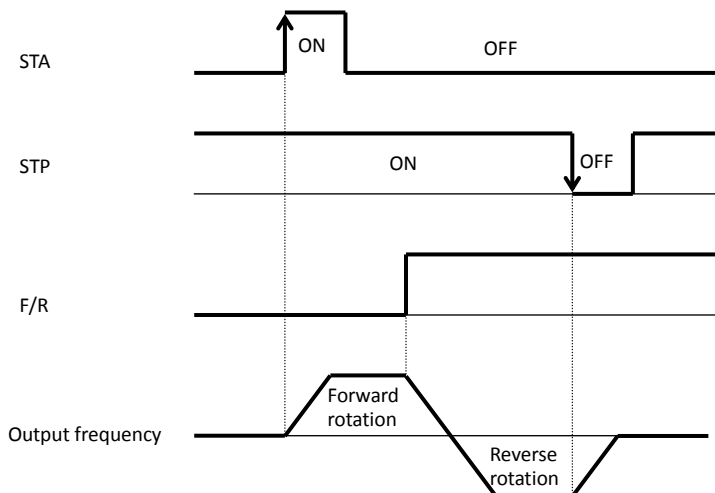

4.2.54 Control gain switching function (CAS)

The control gain switching function allows you to set and switch between two types of gains and time constants for the speed control system (with proportional and integral compensations) when the V/F characteristic curve selection is the sensorless vector control, 0Hz-range sensorless vector control, or vector control with sensor. To use this function, assign function "26" (CAS: control gain setting) to one of the terminal [1] to [8] functions (C001 to C008).

When the CAS terminal is turned off, the gain settings "H050", "H250", "H051", "H251", "H052", and "H252" are selected. When the CAS terminal is turned on, the gain settings "H070", "H071", and "H072" are selected. If function "26" (CAS: control gain setting) is not assigned to any intelligent input terminal, the same gain settings as those selected when the CAS terminal is off are selected.

Related code

A044/A244: V/F characteristic curve selection, 1st/2nd motors
 C001 to C008: Terminal [1] to [8] functions
 H005/H205: Motor speed constant, 1st/2nd motors
 H050/H250: PI proportional gain, 1st/2nd motors
 H051/H251: PI integral gain, 1st/2nd motors
 H052/H252: P proportional gain setting, 1st/2nd motors
 H070: Terminal selection PI proportional gain setting
 H071: Terminal selection PI integral gain setting
 H072: Terminal selection P proportional gain setting

Item	Function code	Data or range of data	Description
V/F characteristic curve selection	A044/A244	03	Sensorless vector control
		04	0Hz-range sensorless vector control
		05	V2 (not available for "A244")
Terminal function	C001 to C008	26	CAS: Control gain setting
Motor speed constant, 1st/2nd motors	H005/H205	0.001 to 9.999, 10.00 to 80.00	
PI proportional gain	H050/H250	0.0 to 999.9, 1000 (%)	
PI integral gain	H051/H251	0.0 to 999.9, 1000 (%)	
P proportional gain	H052/H252	0.01 to 10.00	
Terminal selection PI proportional gain setting	H070	0.0 to 999.9, 1000 (%)	
Terminal selection PI integral gain setting	H071	0.0 to 999.9, 1000 (%)	
Terminal selection P proportional gain setting	H072	0.00 to 10.00	
Gain switching time	H073	0. to 9999. (ms)	Taper time at gain switching

4.2.55 P/PI switching function (PPI)

The P/PI switching function allows you to switch the control (compensation) mode of the speed control system between the proportional integrated compensation and proportional compensation modes when the V/F characteristic curve selection is the sensorless vector control, 0Hz-range sensorless vector control, or vector control with sensor.

To use this function, assign function "43" (PPI: P/PI mode selection) to one of the terminal [1] to [8] functions (C001 to C008).

When the PPI terminal is turned off, the proportional integrated compensation mode is selected. When the PPI terminal is turned on, the proportional compensation mode is selected.

If function "43" (PPI: P/PI mode selection) is not assigned to any intelligent input terminal, the proportional integrated compensation mode is selected.

Related code

A044/A244: V/F characteristic curve selection, 1st/2nd motors
 C001 to C008: Terminal [1] to [8] functions
 H005/H205: Motor speed constant, 1st/2nd motors
 H050/H250: PI proportional gain, 1st/2nd motors
 H051/H251: PI integral gain, 1st/2nd motors
 H052/H252: P proportional gain setting, 1st/2nd motors

Item	Function code	Data or range of data	Description
V/F characteristic curve selection, 1st/2nd/3rd motors	A044/A244/ A344	03	Sensorless vector control (not available for "A344")
		04	0Hz-range sensorless vector control (not available for "A344")
		05	V2 (not available for "A244" and "A344")
Terminal function	C001 to C008	43	PPI: P/PI mode selection
Motor speed constant, 1st/2nd motors	H005/H205	0.001 to 80.000	
PI proportional gain	H050/H250	0.0 to 999.9, 1000 (%)	
PI integral gain	H051/H251	0.0 to 999.9, 1000 (%)	
P proportional gain	H052/H252	0.001 to 10.00	
Terminal selection PI proportional gain setting	H070	0.0 to 999.9, 1000 (%)	

The speed control normally incorporates the proportional integrated compensation (PI control), and the motor speed is controlled so that the difference between the frequency specified by the frequency command and the actual motor speed is zero. However, a specific operation mode (called drooping operation), in which one load is driven by multiple motors, sometimes requires the proportional control (P control). To enable the proportional (P) control mode, assign function "43" (P/PI switching function) to one of the terminal [1] to [8] functions (C001 to C008), and turn on the intelligent input terminal. For the proportional control, set the value of the P control proportional gain (H052) as the KPP value.

The following formula generally represents the relation between the KPP value and momentary speed variation:

$$(\text{Momentary speed variation}) = \frac{10}{(\text{Set value of KPP})} (\%)$$

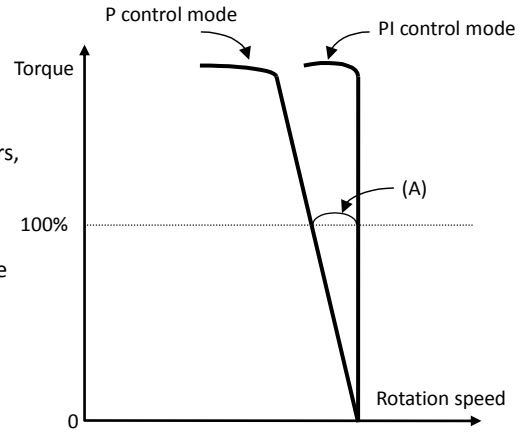

The following formula generally represents the relation between the momentary speed variation and speed error:

$$(\text{Momentary speed variation}) = \frac{\text{Speed error at rated torque (A)}}{\text{Synchronous rotation speed at base frequency}} \times 100\%$$

4.2.56 Analog command holding function (AHD)

- The analog command holding function allows you to make the inverter hold the analog command input via the external analog input terminal when the AHD terminal is on.
- While the AHD terminal is on, the up/down function can be used based on the analog signal held by this function as reference data.
- When "01" is specified for Up/Down memory mode selection (C101), the result of up/down processing can be stored in memory.
- If the inverter power is turned on or the RS terminal turned off with the AHD terminal left turned on, the data held immediately before power-on or turning off the RS terminal will be used.

Related code
C001 to C008: Terminal [1] to [8] functions
C101 : UP/DWN holding function

Item	Function code	Data	Description
Terminal [1] to [8] functions	C001 to C008	65	AHD: Analog command holding

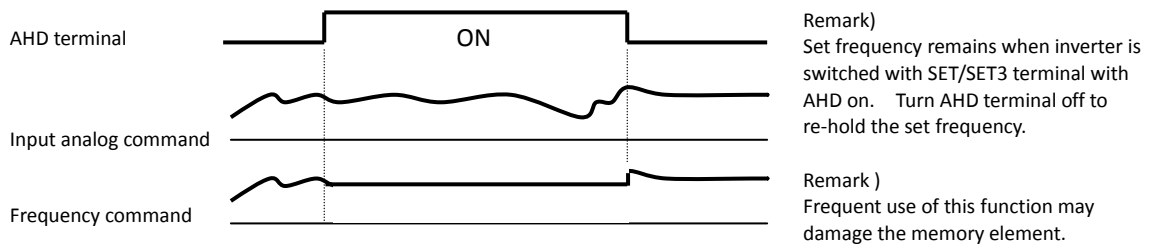

4.2.57 Intelligent pulse counter (PCNT and PCC)

- The intelligent pulse counter function allows you to input a pulse train via an intelligent input terminal.
- The cumulative count of input pulses can be monitored by the pulse counter monitor (d028) function.
- The value of cumulative counter cannot be stored. The counter value is cleared to zero when the inverter power is turned on or the inverter reset.
- Turning on the PCC (pulse counter clear)terminal clears the cumulative counter.
- The frequency resolution of the input pulse can be calculated by the formula shown below (for pulse signal input with a duty ratio of 50%). Frequencies not less than the relevant resolution cannot be input. It is recommended to use this function up to 100Hz. For the input terminal response, see Section 4.2.79.

Related code
C001 to C008: Terminal [1] to terminal [8] functions
d028: Pulse counter monitor

$$\text{Frequency resolution (Hz)} = 250 / (\text{input terminal response time setting [C160 to C168]} + 1)$$

Example: When the input terminal response time is 1, the frequency resolution is 125 Hz.

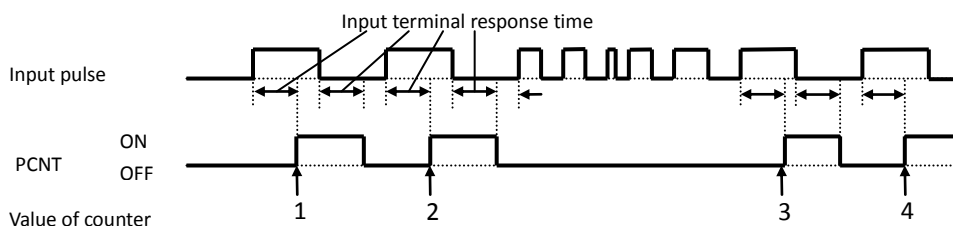

4.2.58 Intelligent output terminal setting

You can assign the functions described below to the intelligent output terminals [11] to [15] (C021 to C025) and the alarm relay terminal (C026).

The intelligent output terminals [11] to [15] are used for open-collector output, and the alarm relay terminal is used for relay output.

You can select the a-contact or b-contact output for individual output terminals by using functions "C031" to "C035" and "C036".

When "01" (3 bits) or "02" (4 bits) is specified for the alarm code output "C062" (see Section 4.2.65), the alarm code output is assigned to output terminals 11 to 13 or output terminals 11 to 14 (AC0 to AC3), respectively. Subsequently, the settings of "C021" to "C024" are invalidated.

Related code
C021 to C025: Terminal [11] to [15] functions
C026: Alarm relay terminal function

Data	Description	Reference item	Page
00	RUN: Running signal	Running signal (RUN)	4-62
01	FA1: Constant-speed reached	Frequency-arrival signals	4-62
02	FA2: Set frequency overreached		
03	OL: Overload notice advance signal (1)	Overload restriction/overload notice advance signal	4-40
04	OD: Output deviation for PID control	PID function	4-26
05	AL: Alarm signal	Protective functions	—
06	FA3: Set frequency reached	Frequency-arrival signals	4-62
07	OTQ: Over-torque	Over-torque signal	4-65
08	IP: Instantaneous power failure	Instantaneous power failure/undervoltage	4-35
09	UV: Undervoltage		
10	TRQ: Torque limited	Torque limitation function	4-92
11	RNT: Operation time over	Operation time over signal	4-64
12	ONT: Plug-in time over	Plug-in time over signal	4-64
13	THM: Thermal alarm signal	Electronic thermal protection	4-37
19	BRK: Brake release	Brake control function	4-81
20	BER: Brake error		
21	ZS: 0 Hz detection signal	0 Hz detection signal	4-64
22	DSE: Speed deviation maximum	V2 control mode selection function	4-96
23	POK: Positioning completed	Orientation function	4-104
24	FA4: Set frequency overreached 2	Frequency-arrival signals	4-62
25	FA5: Set frequency reached 2		
26	OL2: Overload notice advance signal (2)	Overload restriction/overload notice advance signal	4-40
27	Odc: Analog O disconnection detection	Window comparators function	4-71
28	OIDc: Analog OI disconnection detection		
29	O2Dc: Analog O2 disconnection detection		
31	FBV: PID feedback comparison	PID function	4-26
32	NDc: Communication line disconnection	RS485	4-67
33	LOG1: Logical operation result 1	Logical operation function	4-66
34	LOG2: Logical operation result 2		
35	LOG3: Logical operation result 3		
36	LOG4: Logical operation result 4		
37	LOG5: Logical operation result 5		
38	LOG6: Logical operation result 6		
39	WAC: Capacitor life warning	Capacitor life warning	4-67
40	WAF: Cooling-fan speed drop	Cooling-fan speed drop	4-68
41	FR: Starting contact signal	Starting contact signal	4-68
42	OHF: Heat sink overheat warning	Heat sink overheat warning	4-68
43	LOC: Low-current indication signal	Low-current indication signal	4-69
44	M01: General output 1	Easy sequence function	—
45	M02: General output 2		
46	M03: General output 6		
47	M04: General output 4		
48	M05: General output 5		
49	M06: General output 6		
50	IRDY: Inverter ready	Inverter ready signal	4-69
51	FWR: Forward rotation	Forward rotation signal	4-69
52	RVR: Reverse rotation	Reverse rotation signal	4-70

Data	Description	Reference item	Page
53	MJA: Major failure	Major failure signal	4-70
54	WCO	Window comparators function	4-71
55	WCOI		
56	WCO		

4.2.59 Intelligent output terminal a/b (NO/NC) selection

The intelligent output terminal a/b (NO/NC) selection function allows you to specify a-contact or b-contact output for each of the intelligent output terminals [11] to [15] and the alarm relay terminal. The intelligent output terminals [11] to [15] are used for open-collector output, and the alarm relay terminal is used for relay output.

Related code
 C031 to C035: Terminal [11] to [15] active state
 C036: Alarm relay active state

Item	Function code	Data	Description
Terminal active state	C031 to C035	00	a-contact (NO)
		01	b-contact (NC)
Alarm relay active state	C036	00	a-contact (NO)
		01	b-contact (NC)

- An a-contact turns on the output signal when closed and turns it off when opened.
- A b-contact turns on the output signal when opened and turns it off when closed.

(1) Specifications of intelligent output terminals [11] to [15]
 Intelligent output terminals [11] to [15] have the following specifications:

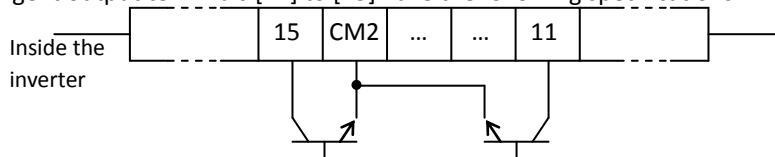

Setting of C031 to C035	Power supply	Output signal
00 (a-contact)	ON	ON
	OFF	—
01 (b-contact)	ON	OFF
	OFF	—

Electric characteristics
 (Between each terminal and CM2)
 Voltage drop when turned on: 4 V or less
 Allowable maximum voltage: 27 VDC
 Allowable maximum current: 50 mA

(2) Specifications of alarm relay terminal

The alarm relay terminal uses a normally-closed (NC) contact that operates as described below.

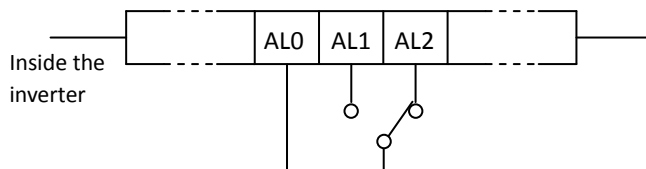

Example of operation as an alarm output terminal

Setting of C036	Power supply	Inverter status	Output terminal state			Resistance load		Inductive load	
			AL1-AL0	AL2-AL0					
00	ON	Error	Closed	Open	AL1-AL0	Maximum contact capacity	250 VAC, 2 A	250 VAC, 2 A	30 VDC, 8 A
		Normal	Open	Closed			30 VDC, 3 A	30 VDC, 2 A	
	OFF	—	Open	Closed		Minimum contact capacity	100 V AC, 10 mA		5 VDC, 100 mA
01 (default)	ON	Error	Open	Closed	AL2-AL0	Maximum contact capacity	250 VAC, 1A	250 VAC, 0.2 A	30 VDC, 0.2 A
		Normal	Closed	Open			30 VDC, 1A	30 VDC, 0.2 A	
	OFF	—	Open	Closed		Minimum contact capacity	100 VAC, 10 mA		5 VDC, 100 mA

4.2.60 Running signal (RUN)

While the inverter is operating, it outputs the running (RUN) signal via an intelligent output terminal ([11] to [15]) or the alarm relay terminal. To use this signal function, assign function "00" (RUN) to one of the intelligent output terminals [11] to [15] (C021 to C025) and the alarm relay terminal (C026).

The inverter outputs the RUN signal even while operating the DC brake. The following figure shows a timing chart for the signal output:

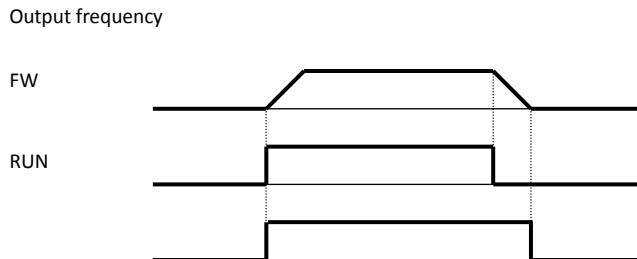

Related code
C021 to C025: Terminal [11] to [15] functions

4.2.61 Frequency arrival signals (FA1, FA2, FA3, FA4, and FA5)

The inverter outputs a frequency-arrival signal when the inverter output frequency reaches a set frequency.

When using the inverter for a lift, use the frequency-arrival signal as a trigger to start braking. Use the over-torque signal as the trigger to stop braking.

Assign the following functions to five of the intelligent output terminals [11] to [15] (C021 to C025) and the alarm relay terminal (C026):

"01" (FA1: constant-speed reached), "02" (FA2: set frequency overreached), "06" (FA3: set frequency reached), "24" (FA4: set frequency overreached 2), and "25" (FA5: set frequency reached 2)

The hysteresis of each frequency-arrival signal is as follows:

- When the signal is on: ("set frequency" - "1% of maximum frequency") (Hz)
- When the signal is off: ("set frequency" - "2% of maximum frequency") (Hz)

The signal hysteresis at acceleration with function "06" (FA3) or "25" (FA5) set is as follows:

- When the signal is on: ("set frequency" - "1% of maximum frequency") (Hz)
- When the signal is off: ("set frequency" + "2% of maximum frequency") (Hz)

The signal hysteresis at deceleration with function "06" (FA3) or "25" (FA5) set is as follows:

- When the signal is on: ("set frequency" + "1% of maximum frequency") (Hz)
- When the signal is off: ("set frequency" - "2% of maximum frequency") (Hz)

Related code
C021 to C025: Terminal [11] to [15] functions
C042: Frequency arrival setting for accel.
C043: Frequency arrival setting for decel.
C045: Frequency arrival setting for acceleration (2)
C046: Frequency arrival setting for deceleration (2)

Item	Function code	Range of data	Description
Frequency arrival setting for accel./Frequency arrival setting for acceleration (2)	C042/C045	0.0 (Hz)	Disabling the output of frequency
		0.01 to 400.0 (Hz)	Enabling the output of frequency
Frequency arrival setting for decel./Frequency arrival setting for deceleration (2)	C043/C046	0.0 (Hz)	Disabling the output of frequency
		0.01 to 400.0 (Hz)	Enabling the output of frequency

(1) Signal output when the constant-speed frequency is reached (01: FA1)

The inverter outputs the signal when the output frequency reaches the frequency specified by a frequency setting (F001, A020, A220, or A320) or multispeed setting (A021 to A035).

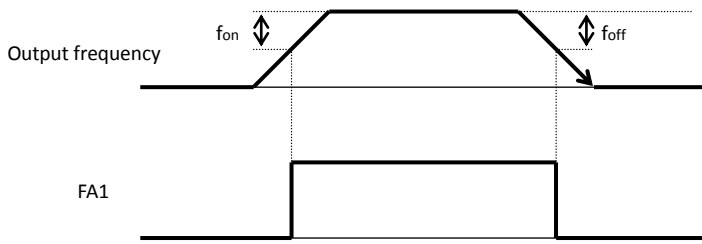

Set frequency $\left\{ \begin{array}{l} f_{on}: 1\% \text{ of maximum frequency} \\ f_{off}: 2\% \text{ of maximum frequency} \end{array} \right.$

(Example)

Maximum frequency (f_{max}) = 120 Hz

Set frequency (f_{set}) = 60 Hz

$f_{on} = 120 \times 0.01 = 1.2$ (Hz)

$f_{off} = 120 \times 0.02 = 2.4$ (Hz)

At acceleration, the signal turns on when the output frequency reaches 58.8 Hz ($60 - 1.2 = 58.8$).

At deceleration, the signal turns off when the output frequency reaches 57.6 Hz ($60 - 2.4 = 57.6$).

(2) Signal output when the set frequency is exceeded (02: FA2 or 24: FA4)

The inverter outputs the signal when the output frequency exceeds the acceleration or deceleration frequency specified by a frequency setting ("C042" or "C043" [FA2] or "C045" or "C046" [FA4]).

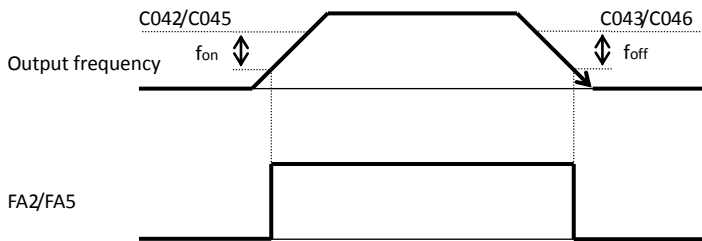

$f_{on}: 1\% \text{ of maximum frequency}$
 $f_{off}: 2\% \text{ of maximum frequency}$

(3) Signal output only when the set frequency is reached (06: FA3 or 25: FA5)

The inverter outputs the signal only when the output frequency reaches the frequency specified by a frequency setting ("C042" or "C043" [FA3] or "C045" or "C046" [FA5]).

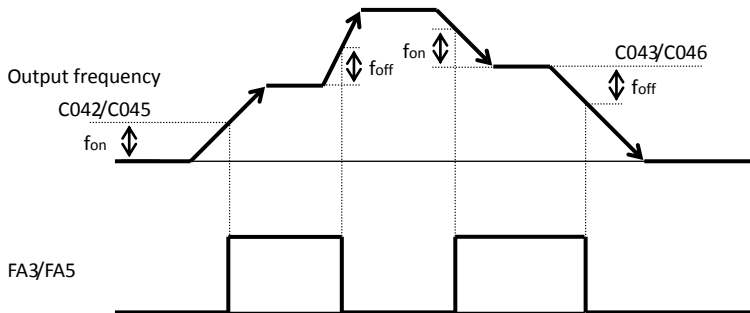

$f_{on}: 1\% \text{ of maximum frequency}$
 $f_{off}: 2\% \text{ of maximum frequency}$

4.2.62 Running time over and power-on time over signals (RNT and ONT)

The inverter outputs the operation time over (RNT) signal or the plug-in time over (ONT) signal when the time specified as the run/power-on warning time (b034) is exceeded.

Related code

b034: Run/power-on warning time
 C021 to C025: Terminal [11] to [15] functions
 C026: Alarm relay terminal function
 d016: Cumulative operation RUN time monitoring
 d017: Cumulative power-on time monitoring

Item	Function code	Range of data	Description
Run/power-on warning time	b034	0. 1. to 9999. 1000 to 6553	Disabling the signal output Setting in units of 10 hours Setting in units of 100 hours (range: 100,000 to 655,300 hours)

(1) Operation time over (RNT) signal

To use this signal function, assign function "11" (RNT) to one of the intelligent output terminals [11] to [15] (C021 to C025) and the alarm relay terminal (C026).

Specify the run/power-on warning time (b034).

(2) Plug-in time over (ONT) signal

To use this signal function, assign function "12" (ONT) to one of the intelligent output terminals [11] to [15] (C021 to C025) and the alarm relay terminal (C026).

Specify the run/power-on warning time (b034).

4.2.63 0 Hz speed detection signal (ZS)

The inverter outputs the 0 Hz speed detection signal when the inverter output frequency falls below the threshold frequency specified as the zero speed detection level (C063).

To use this signal function, assign function "21" (ZS) to one of the intelligent output terminals [11] to [15] (C021 to C025) and the alarm relay terminal (C026).

Related code

A044/A244/A344: V/F characteristic curve selection, 1st/2nd/3rd motors
 C021 to C025: Terminal [11] to [15] functions
 C063: Zero speed detection level

This signal function applies to the inverter output frequency when the V/F characteristic curve selection is based on the constant torque characteristic (VC), reduced-torque characteristic (1.7th power of VP), free V/f characteristic, sensorless vector control, or 0Hz-range sensorless vector control. It applies to the motor speed when the V/F characteristic curve selection is based on the vector control with sensor.

Item	Function code	Data or range of data	Description
Terminal function	C021 to C025	21	ZS: 0 Hz speed detection signal
Alarm relay terminal function	C026		
Zero speed detection level	C063	0.00 to 100.0 (Hz)	Setting of the frequency to be determined as 0 Hz

4.2.64 Over-torque signal (OTQ)

The inverter outputs the over-torque signal when it detects that the estimated motor output torque exceeds the specified level. To enable this function, assign function "07" (OTQ: over-torque signal) to an intelligent output terminal.

This function is effective only when the V/F characteristic curve selection selected with function "A044" or "A244" is the sensorless vector control, 0Hz-range sensorless vector control, or vector control with sensor. With any other V/F characteristic curve selection, the output of the OTQ signal is unpredictable.

When using the inverter for a lift, use the OTQ signal as the trigger to stop braking. Use the frequency-arrival signal as the trigger to start braking.

Related code

A044/A244/A344: V/F characteristic curve selection, 1st/2nd/3rd motors
 C021 to C025: Terminal [11] to [15] functions
 C055: Over-torque (forward-driving) level setting
 C056: Over-torque (reverse regenerating) level setting
 C057: Over-torque (reverse driving) level setting
 C058: Over-torque (forward regenerating) level setting

Item	Function code	Set value	Description
Terminal function	C021 to C025	07	OTQ: Over-torque signal
Alarm relay terminal function	C026		
Over-torque (forward-driving) level setting	C055	CT mode : 0. to 200. (%) <0. to 180.(%)> VT mode : 0. to 150. (%) <0. to 150.(%)>	Threshold level to output the OTQ signal during forward powering operation
Over-torque (reverse regenerating) level setting	C056		Threshold level to output the OTQ signal during reverse regeneration operation
Over-torque (reverse driving) level setting	C057		Threshold level to output the OTQ signal during reverse powering operation
Over-torque (forward regenerating) level setting	C058		Threshold level to output the OTQ signal during forward regeneration operation

(NOTE)<>:applied for 75 to 150kW

4.2.65 Alarm code output function (AC0 to AC3)

The alarm code output function allows you to make the inverter output a 3- or 4-bit code signal as the trip factor when it has tripped.

Specifying "01" (3 bits) or "02" (4 bits) for the alarm code output (C062) forcibly assigns the alarm code output function to intelligent output terminals [11] to [13] or [11] to [14], respectively.

The following table lists the alarm codes that can be output:

Related code

C021 to C025: Terminal [11] to [15] functions
 C062: Alarm code output

Intelligent output terminals				When "4 bits" is selected		When "3 bits" is selected	
14	13	12	11	Factor code	Cause of tripping	Factor code	Cause of tripping
AC3	AC2	AC1	AC0				
0	0	0	0	Normal	Normal operation	Normal	Normal
0	0	0	1	E01 to E03, E04	Overcurrent protection	E01 to E03, E04	Overcurrent protection
0	0	1	0	E05, E38	Overload protection Low-speed overload protection	E05	Overload protection Low-speed overload protection
0	0	1	1	E07, E15	Overvoltage/input overvoltage protection	E07, E15	Overvoltage/input overvoltage protection
0	1	0	0	E09	Undervoltage protection	E09	Undervoltage protection
0	1	0	1	E16	Instantaneous power failure protection	E16	Instantaneous power failure protection
0	1	1	0	E30	IGBT error	E30	IGBT error
0	1	1	1	E06	Braking resistor overload protection	—	Other error
1	0	0	0	E08, E11, E23, E25	EEPROM, CPU, GA communication, or main circuit error	—	—
1	0	0	1	E10	CT error	—	—
1	0	1	0	E12, E13, E35, E36	External trip, USP error, thermistor error, or braking error	—	—
1	0	1	1	E14	Ground-fault protection	—	—
1	1	0	0	E43, E44, E45	Invalid instruction in easy sequence Nesting error in easy sequence Easy sequence execution command error	—	—

Intelligent output terminals				When "4 bits" is selected		When "3 bits" is selected	
14 AC3	13 AC2	12 AC1	11 AC0	Factor code	Cause of tripping	Factor code	Cause of tripping
1	1	0	1	E20, E21	Temperature error due to low cooling-fan speed Temperature error	—	—
1	1	1	0	E24	Phase loss input protection	—	—
1	1	1	1	E50 to E79	Easy sequence user trip 0-9, option 1,2 error 0-9	—	—

Item	Function code	Data	Description
Alarm code output	C062	00	No output of alarm code
		01	Output of 3-bit code
		02	Output of 4-bit code

4.2.66 Logical output signal operation function (LOG1 to LOG6)

The logical output signal operation function allows you to make the inverter internally perform a logical operation of output signals. This function applies to all output signals, except to logical operation results (LOG1 to LOG6).

Three types of operators (AND, OR, and XOR) are selectable.

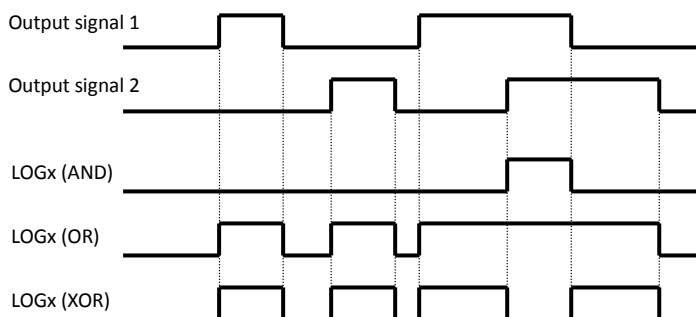

Related code

C021 to C025: Terminal [11] to [15] functions
 C026: Alarm relay terminal function
 C142: Logical output signal 1 selection 1
 C143: Logical output signal 1 selection 2
 C144: Logical output signal 1 operator selection
 C145: Logical output signal 2 selection 1
 C146: Logical output signal 2 selection 2
 C147: Logical output signal 2 operator selection
 C148: Logical output signal 3 selection 1
 C149: Logical output signal 3 selection 2
 C150: Logical output signal 3 operator selection
 C151: Logical output signal 4 selection 1
 C152: Logical output signal 4 selection 2
 C153: Logical output signal 4 operator selection
 C154: Logical output signal 5 selection 1
 C155: Logical output signal 5 selection 2
 C156: Logical output signal 5 operator selection
 C157: Logical output signal 6 selection 1
 C158: Logical output signal 6 selection 2
 C159: Logical output signal 6 operator selection

The necessary parameters depend on the logical output signal to be operated. The following table lists the parameters to be set for each logical output signal:

Selected signal	Operation-target 1 selection	Operation-target 2 selection	Operator selection
33: Logical output signal 1 (LOG1)	C142	C143	C144
34: Logical output signal 2 (LOG2)	C145	C146	C147
35: Logical output signal 3 (LOG3)	C148	C149	C150
36: Logical output signal 4 (LOG4)	C151	C152	C153
37: Logical output signal 5 (LOG5)	C154	C155	C156
38: Logical output signal 6 (LOG6)	C157	C158	C159

(Example) To output the AND of the running signal (00: RUN) and set the frequency overreached signal (02: FA2) as the logical output signal 1 (LOG1) to the intelligent output terminal [2]:

- Intelligent output terminal [2] (C002): 33 (LOG1)
- Logical output signal 1 selection 1 (C142): 00 (RUN)
- Logical output signal 1 selection 2 (C143): 02 (FA2)
- Logical output signal 1 operator (C143): 00 (AND)

Item	Function code	Data or range of data	Description
Terminal function	C021 to C025 C026	33	LOG1: Logical operation result 1 (C142, C143, and C144)
		34	LOG2: Logical operation result 2 (C145, C146, and C147)
		35	LOG3: Logical operation result 3 (C148, C149, and C150)
Alarm relay terminal function		36	LOG4: Logical operation result 4 (C151, C152, and C153)
		37	LOG5: Logical operation result 5 (C154, C155, and C156)
		38	LOG6: Logical operation result 6 (C157, C158, and C159)
Logical output signal selection 1	C142/C145/C148/ C151/C154/C157	Selection of "00" to "56" from the data (except LOG1 to LOG6) output to intelligent output terminals	Selection of operation-target 1
Logical output signal selection 2	C143/C146/C149/ C152/C155/C158	Selection of "00" to "56" from the data (except LOG1 to LOG6) output to intelligent output terminals	Selection of operation-target 2
Logical output signal operator selection	C144/C147/C150/ C153/C156/C159	00	AND
		01	OR
		02	XOR

4.2.67 Capacitor life warning signal (WAC)

The inverter checks the operating life of the capacitors on the internal circuit boards on the basis of the internal temperature and cumulative power-on time.

You can monitor the state of the capacitor life warning (WAC) signal by using the life-check monitoring function (d022). If the WAC signal is output, you are recommended to replace the main circuit and logic circuit boards.

Item	Function code	Data or range of data	Description
Terminal function	C021 to C025	39	WAC: Capacitor life warning signal (for on-board capacitors)
Alarm relay terminal function	C026		

Related code

C021 to C025: Terminal [11] to [15] functions
C026: Alarm relay terminal function

4.2.68 Communication line disconnection signal (NDc)

This signal function is enabled only when ModBus-RTU has been selected for the RS485 communication.

If a reception timeout occurs, the inverter continues to output the communication line disconnection signal until it receives the next data.

Specify the limit time for reception timeout by setting the communication trip time (C077). For details, see Section 4.4, "Communication Functions."

Related code

C021 to C025: Terminal [11] to [15] functions
C026: Alarm relay terminal function
C077: Communication trip time

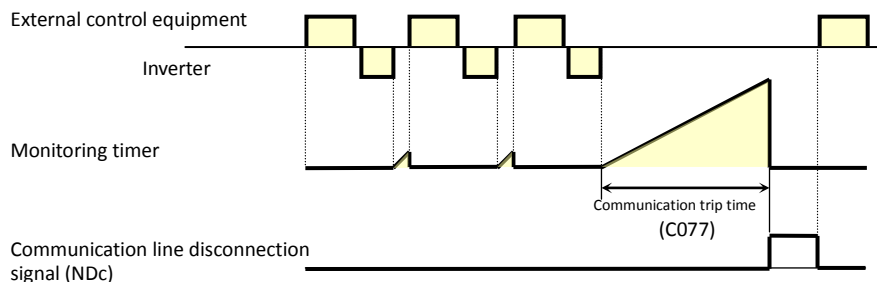

Item	Function code	Data or range of data	Description
Terminal function	C021 to C025	32	NDc: Communication line disconnection signal
Alarm relay terminal function	C026		
Communication trip time	C077	0.00 to 99.99 (s)	Setting of the limit time for reception timeout

4.2.69 Cooling-fan speed drop signal (WAF)

The inverter outputs the cooling-fan speed drop (WAF) signal when it detects that the rotation speed of its internal cooling fan has fallen to 75% or less of the full speed.

If "01" has been selected for the cooling fan control (b092), the inverter will not output the WAF signal, even when the cooling fan stops.

If the WAF signal is output, check the cooling-fan cover for clogging.

You can monitor the state of the WAF signal by using the life-check monitoring function (d022).

Related code

C021 to C025: Terminal [11] to [15] functions
C026: Alarm relay terminal function
b092: Cooling fan control
d022: Life-check monitoring

Item	Function code	Data	Description
Terminal function	C021 to C025	40	WAF: Cooling-fan speed drop signal
Alarm relay terminal function	C026		

4.2.70 Starting contact signal (FR)

The inverter outputs the starting contact (FR) signal while it is receiving an operation command.

The FR signal is output, regardless of the setting of the run command source setting (A002).

If the forward operation (FW) and reverse operation (RV) commands are input at the same time, the inverter stops the motor operation.

Related code

C021 to C025: Terminal [11] to [15] functions
C026: Alarm relay terminal function

Item	Function code	Data	Description
Terminal function	C021 to C025	41	FR: Starting contact signal
Alarm relay terminal function	C026		

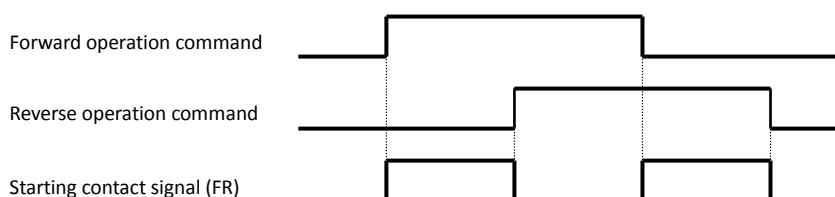
**4.2.71 Heat sink overheat warning signal (OHF)**

The inverter monitors the temperature of its internal heat sink, and outputs the heat sink overheat warning (OHF) signal when the temperature exceeds the heat sink overheat warning level (C064).

Related code

C021 to C025: Terminal [11] to [15] functions
C026: Alarm relay terminal function
C064: Heat sink overheat warning level

Item	Function code	Data or range of data	Description
Terminal function	C021 to C025	42	OHF: Heat sink overheat warning signal
Alarm relay terminal function	C026		
Heat sink overheat warning level	C064	0. to 200. (°C)	Setting of the threshold temperature at which to output the heat sink overheat warning signal

4.2.72 Low-current indication (LOC) signal

The inverter outputs the low-current indication (LOC) signal when the inverter output current falls to the low-current indication signal detection level (C039) or less.

You can select one of the two signal output modes with the low-current indication signal output mode selection (C038). In one mode, the LOC signal output is always enabled during the inverter operation. In the other mode, the LOC signal output is enabled only while the inverter is driving the motor for constant-speed operation.

Related code

C021 to C025: Terminal [11] to [15] functions
 C026: Alarm relay terminal function
 C038: Low-current indication signal output mode selection
 C039: Low-current indication signal detection level

Item	Function code	Data or range of data	Description
Terminal function	C021 to C025	43	LOC: Low-current indication signal
Alarm relay terminal function	C026		
Low-current indication signal output mode selection	C038	00	Enabling the signal output during operation
		01	Enabling the signal output only during constant-speed operation (*1)
Low-current indication signal detection level	C039	0.0 to 2.0 x rated current (A)	Setting of the threshold current level at which to output the low-current indication signal

(*1) When 01 (control circuit terminal) is selected as frequency source setting (A001), there is a case that inverter does not recognize the speed as constant value due to sampling. In this case, adjusting is to be made by setting C038=00 (valid during operation) or increasing analogue input filter (A016).

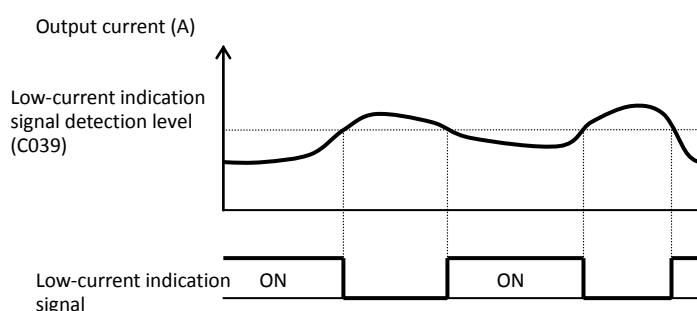

4.2.73 Inverter ready signal (IRDY)

The inverter outputs the inverter ready (IRDY) signal when it is ready for operation (i.e., when it can receive an operation command).

- The inverter can recognize only the operation command that is input while the IRDY signal is output.
- If the IRDY signal is not output, check whether the input power supply voltage (connected to the R, S, and T terminals) is within the range of specification.
- Signal is not output when the power is given only to control power supply.

Related code

C021 to C025: Terminal [11] to [15] functions
 C026: Alarm relay terminal function

Item	Function code	Data or range of data	Description
Terminal function	C021 to C025	50	IRDY: Inverter ready signal
Alarm relay terminal function	C026		

4.2.74 Forward rotation signal (FWR)

The inverter continues to output the forward rotation (FWR) signal while it is driving the motor for forward operation.

The FWR signal is turned off while the inverter is driving the motor for reverse operation or stopping the motor.

Related code

C021 to C025: Terminal [11] to [15] functions
 C026: Alarm relay terminal function

Item	Function code	Data or range of data	Description
Terminal function	C021 to C025	51	FWR: Forward rotation signal
Alarm relay terminal function	C026		

4.2.75 Reverse rotation signal (RVR)

The inverter continues to output the forward rotation (RVR) signal while it is driving the motor for reverse operation.

The RVR signal is turned off while the inverter is driving the motor for forward operation or stopping the motor.

Related code

C021 to C025: Terminal [11] to [15] functions
C026: Alarm relay terminal function

Item	Function code	Data or range of data	Description
Terminal function	C021 to C025	52	RVR: Reverse rotation signal
Alarm relay terminal function	C026		

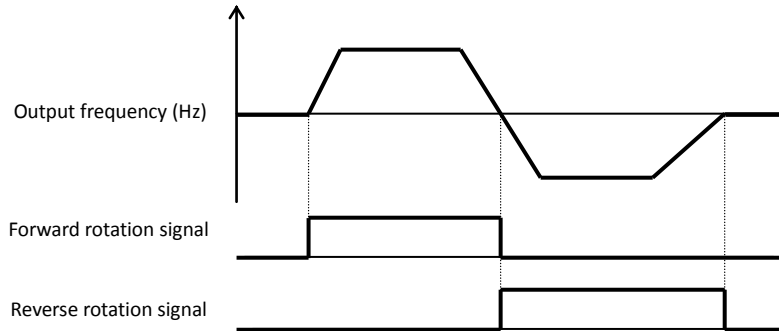

4.2.76 Major failure signal (MJA)

The inverter outputs the major failure (MJA) signal in addition to an alarm signal when it trips because of one of the errors listed below. (This signal function applies to the tripping caused by hardware.)

Related code

C021 to C025: Terminal [11] to [15] functions
C026: Alarm relay terminal function

No.	Error code	Description
1	E10.*	CT error
2	E11.*	CPU error
3	E14.*	Ground-fault protection
4	E20.*	Temperature error due to cooling-fan fault
5	E23.*	Gate array communication error
6	E25.*	Main circuit error

Item	Function code	Data or range of data	Description
Terminal function	C021 to C025	53	MJA: Major failure signal
Alarm relay terminal function	C026		

4.2.77 Window comparators (WCO/WCOI/WCO2) (detection of terminal disconnection: ODC/OIDc/O2Dc)

- The window comparator function outputs signals when the values of analog inputs O, OI, and O2 are within the maximum and minimum limits specified for the window comparator. You can monitor analog inputs with reference to arbitrary levels (to find input terminal disconnection and other errors).
- You can specify a hysteresis width for the maximum-limit and minimum-limit levels of the window comparator.
- You can specify limit levels and a hysteresis width individually for analog inputs O, OI, and O2.
- You can fix the analog input data to be applied to an arbitrary value when WCO, WCOI, or WCO2 is output. For this purpose, specify a desired value as the operation level at O/OI/O2 disconnection (b070/b071/b072). When "no" is specified, the analog input data is reflected as input.
- Output values of ODC, OIDc, and O2Dc are the same as those of WCO, WCOI, and WCO2, respectively.

Related code
C021 to C025: Terminal [11] to terminal [15] functions
C026: Alarm relay terminal function
b060/b063/b066: Maximum-limit level of window comparators O/OI/O2
b061/b064/b067: Minimum-limit level of window comparators O/OI/O2

Item	Function code	Range of data	Description
Terminal [11] to terminal [15] functions	C021-C025 C026	27	ODc: Detection of analog input O disconnection
		28	OIdc: Detection of analog input OI disconnection
		29	O2Dc: Detection of analog input O2 disconnection
Alarm relay terminal function		54	WCO: Window comparator O
		55	WCOI: Window comparator OI
		56	WCO2: Window comparator O2
Maximum-limit level of window comparators O/OI/O2	b060 (O)	"Minimum-limit level + hysteresis width*2 (minimum of 0)" to 100. (%)	Setting of maximum-limit level
	b063 (OI)		
	b066 (O2)		
Minimum-limit level of window comparators O/OI/O2	b061 (O)	0 to "maximum-limit level - hysteresis width*2 (maximum of 100)" (%)	Setting of minimum-limit level
	b064 (OI)		
	b067 (O2)		
Hysteresis width of window comparators O/OI/O2	b062 (O)	0 to "(maximum-limit level - minimum-limit level)/2 (maximum of 10)" (%)	Setting of hysteresis width for maximum-limit and minimum-limit levels
	b065 (OI)		
	b068 (O2)		
Operation level at O/OI/O2 disconnection	b070 (O)	0 to 100 (%) or "no" (ignore)	Setting of the analog input value to be applied when WCO, WCOI, or WCO2 (ODc, OIdc, or O2Dc) is output.
	b071 (OI)		
	b072 (O2)		

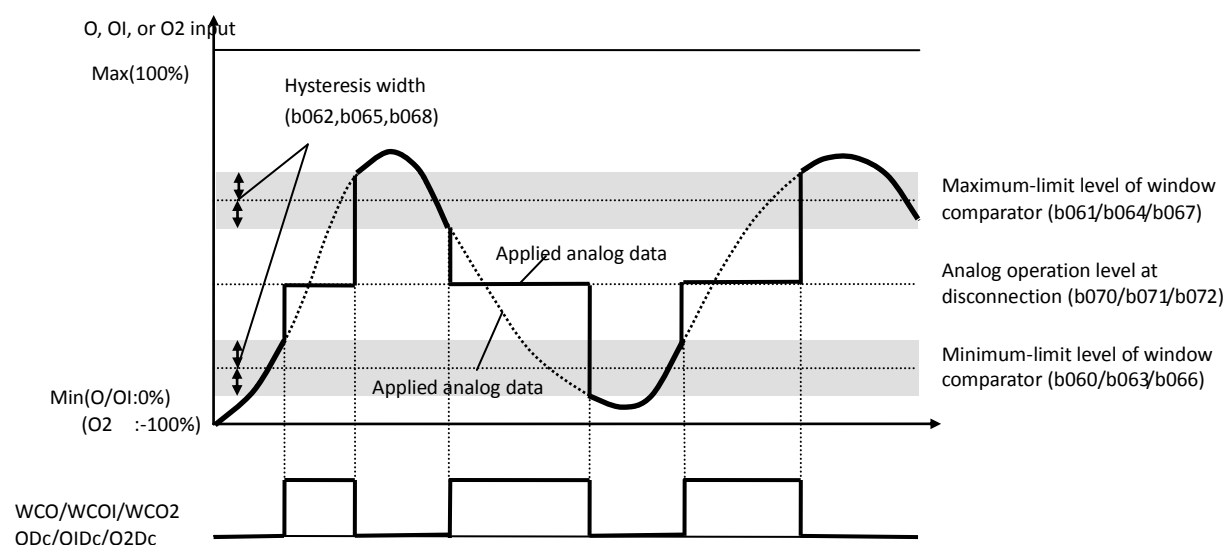

4.2.78 Output signal delay/hold function

The output signal delay/hold function allows you to set on-delay and off-delay times for each output terminal.

Since every output signal is turned on or off immediately when the relevant condition is satisfied, signal chattering may occur if signal outputs conflict with each other. Use this function to avoid such a problem by holding or delaying specific signal outputs.

To use this function, set on-delay and off-delay times for individual output terminals (a total of six terminals, such as intelligent output terminals [11] to [15] and the alarm relay terminal).

Output terminal	On-delay time	Off-delay time
11	C130	C131
12	C132	C133
13	C134	C135
14	C136	C137
15	C138	C139
RY(AL*)	C140	C141

Related code

C130: Output 11 on-delay time
 C131: Output 11 off-delay time
 C132: Output 12 on-delay time
 C133: Output 12 off-delay time
 C134: Output 13 on-delay time
 C135: Output 13 off-delay time
 C136: Output 14 on-delay time
 C137: Output 14 off-delay time
 C138: Output 15 on-delay time
 C139: Output 15 off-delay time
 C140: Output RY on-delay time
 C141: Output RY off-delay time

Item	Function code	Range of data	Description
Output on	C130/C132/C134/ C136/C138/C140	0.0 to 100.0 (s)	Setting of on
Output off	C131/C133/C135/ C137/C139/C141	0.0 to 100.0 (s)	Setting of off

4.2.79 Input terminal response time

- The input terminal response time function allows you to specify a sampling time for each of intelligent input terminals 1 to 8 and the FW terminal. You can use this function effectively to remove noise (e.g., chattering).

- If chattering hinders constant input from an input terminal, increase the response time setting for the input terminal. Note that an increase in response time deteriorates the response. The response time can be set in a range of about 2 to 400 ms (corresponding to settings of 0 to 200).

Item	Function code	Range of data	Description
Response time of intelligent input terminals 1 to 8	C160-C167	0. to 200.	Variable in step of 1
FW terminal response time	C168		

Related code

C160 to C167: Response time of intelligent input terminals 1 to 8
 C168: FW terminal response time

4.2.80 External thermistor function (TH)

The external thermistor function allows you to connect an external thermistor installed in external equipment (e.g., motor) to the inverter, and use the thermistor for the thermal protection of the external equipment.

Connect the external thermistor to control circuit terminals TH and CM1.

Make the functional settings according to the thermistor specifications as described below.

When using this function, the wiring distance between the inverter and motor must be 20 m or less. Since the thermistor current is weak, isolate the thermistor wiring to the inverter from other wirings appropriately to prevent the thermistor signal from being affected by the noise caused by other signal currents, including the motor current.

Item	Function code	Range of data	Description
Thermistor for thermal protection control	b098	00	Disabling the external thermistor (TH) function
		01	Enabling the TH function (resistor element with a positive temperature coefficient [PTC])
		02	Enabling the TH function (resistor element with a negative temperature coefficient [NTC])
Thermal protection level setting	b099	0 to 9999. (Ω)	Setting of the thermal resistance level (according to the thermistor specifications) at which to trigger tripping
Thermistor input tuning	C085	0.0 to 1000.	Setting for gain adjustment

Related code

b098: Thermistor for thermal protection control
 b099: Thermal protection level setting
 C085: Thermistor input tuning

Note: Specifying "01" for the thermistor for thermal protection control (b098) without an external thermistor connected makes the inverter trip.

4.2.81 FM terminal

You can monitor the inverter output frequency and output current via the FM terminal on the control circuit terminal block. The FM terminal is a pulse output terminal.

(1) FM signal selection

Select the signal to be output from the FM terminal among those shown below.

If you select "03" (digital output frequency), connect a digital frequency counter to the FM terminal. To monitor other output signals, use an analog meter.

Related code
C027: [FM] signal selection
b081: [FM] terminal analog meter adjustment
C030: Digital current monitor reference value
C105: [FM] terminal analog meter adjustment

Item	Data	Description	Full-scale value
C027	00	Output frequency (See example 1.)	0 to maximum frequency (Hz) (*3)
	01	Output current (See example 1.)	0 to 200%
	02	Output torque (*1) (See example 1.)	0 to 200%
	03	Digital output frequency (See example 2.)	0 to maximum frequency (Hz) (*3)
	04	Output voltage (See example 1.)	0 to 133% (75% of full scale is equivalent to 100%)
	05	Input power (See example 1.)	0 to 200%
	06	Electronic thermal overload (See example 1.)	0 to 100%
	07	LAD frequency (See example 1.)	0 to maximum frequency (Hz)
	08	Digital current monitoring (See example 2.)	(*2)
	09	Motor temperature (See example 1.)	0°C to 200°C (0°C is output when the motor temperature is 0°C or less.)
	10	Heat sink temperature (See example 1.)	0°C to 200°C (0°C is output when the motor temperature is 0°C or less.)
	12	General analog YA (0) (See example 1.)	0 to 100%

*1 This signal is output only when the V/F characteristic curve selection (see Section 4.2.18) is the sensorless vector control, 0Hz-range sensorless vector control, or vector control with sensor.

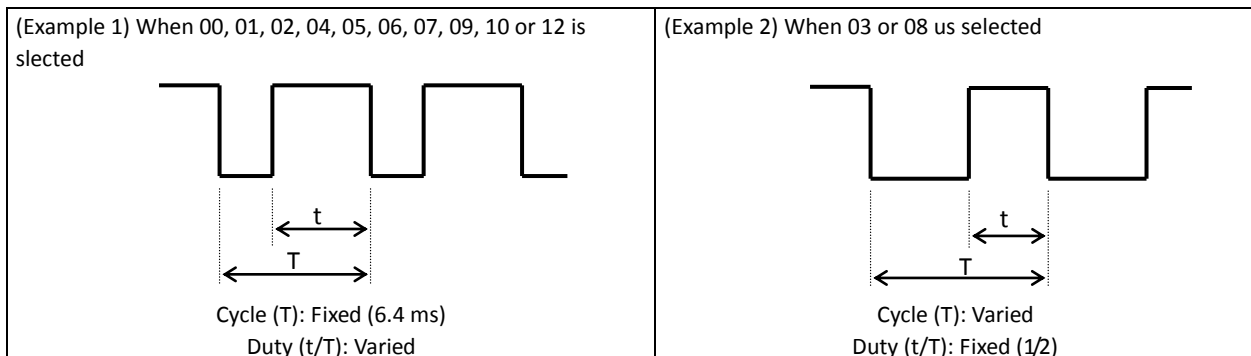

***2 Digital current monitoring**

If the output current matches the digital current monitor reference value (C030), the FM terminal will output a signal indicating 1,440 Hz.

Item	Function code	Range of data	Description
Digital current monitor reference value	C030	"0.2 x rated current" to "2.0 x rated current" (A)	Setting of the current for 1,440 Hz output

*3 The actually detected output frequency is output when the V/F characteristic curve selection is the vector control with sensor (A044 = 05).

*4 For detail of the function, refer "Programming software EZ-SQ user manual".

*5 When b086 (frequency scaling conversion factor) is set, the value converted by gain is displayed. (refer 4.1.7 Scaled output frequency monitoring)

(2) FM terminal analog meter adjustment

Adjust the inverter output gain for the external meter connected to the FM terminal.

Item	Function code	Range of data	Description
[FM] terminal analog meter adjustment	C105	50. to 200. (%)	Setting of the gain for FM monitoring

4.2.82 AM and AMI terminals

You can monitor the inverter output frequency and output current via the AM and AMI terminals on the control circuit block.

The AM terminal outputs an analog voltage signal (0 to 10 V).

The AMI terminal outputs an analog current signal (4 to 20 mA).

The early precision is $\pm 20\%$. Please adjust it as needed.

(1) AM signal selection /AMI signal selection

Select the signals to be output from the AM and AMI terminals among those shown below.

Related code	
C028:	[AM] signal selection
C029:	[AMI] signal selection
C106:	AM gain adjustment
C109:	AM offset adjustment
C108:	AMI gain adjustment
C110:	AMI offset adjustment

Item	Function code	Data	Description	Full-scale value
[AM] signal selection / [AMI] signal selection	C028/C029	00	Output frequency (*3)	0 to maximum frequency (Hz)
		01	Output current	0 to Rated Output current $\times 2.0$
		02	Output torque (*1)	0 to Rated Output torque $\times 2.0$
		04	Output voltage	0 to Rated Output voltage $\times 1.33$ (75% of full scale is equivalent to 100%)
		05	Input power	0 to Rated Input power $\times 2.0$
		06	Electronic thermal overload	0 to 100%
		07	LAD frequency	0 to maximum frequency (Hz)
		09	Motor temperature	0°C to 200°C (0°C is output when the motor temperature is 0°C or less.)
		10	Heat sink temperature	0°C to 200°C (0°C is output when the motor temperature is 0°C or less.)
		11	Output torque (signed) (*1) (*2)	(Output only from the AM terminal) 0 to Rated Output torque $\times 2.0$
		13	General analog YA (1) (*4)	(Output only from the AM terminal) 0 to 100%
		14	General analog YA (2) (*4)	(Output only from the AMI terminal) 0 to 100%

*1 This signal is output only when the V/F characteristic curve selection (see Section 4.2.18) is the sensorless vector control, 0Hz-range sensorless vector control, or vector control with sensor.

*2 The voltage range is 0 to +10V(positive-going only), regardless of forward or reverse motor rotation. In addition, please do offset adjustment when this outputs negative-going of the output torque (signed).

*3 The actually detected output frequency is output when the V/F characteristic curve selection is the vector control with sensor (A044 = 05).

*4 For detail of the function, refer "Programming software EZ-SQ user manual".

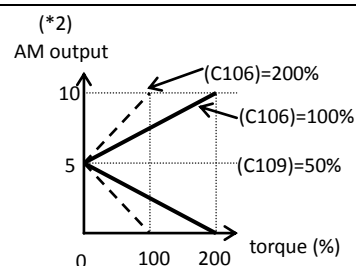

(2) AM/AMI adjustment

The early precision is $\pm 20\%$. Please adjust it as needed.

Adjust the inverter output gain for the external meters connected to the AM and AMI terminals.

Item	Function code	Range of data	Description
AM gain adjustment	C106	50. to 200. (%)	Setting of the gain for AM monitoring
AM offset adjustment	C109	0 to 100 (%)	Setting of the offset for AM monitoring
AMI gain adjustment	C107	50. to 200. (%)	Setting of the gain for AMI monitoring
AMI offset adjustment	C110	0 to 100 (%)(*1)	Setting of the offset for AMI monitoring

*1 When the current range of AMI terminal output is 4 to 20 mA, the offset of 4 mA is approximately 20%.

The adjustment is the following procedure. (In the case of AMI, it is similar)

- In a state of C028=00, and please run motor at the maximum frequency.
- Adjust offset C109 first, and then use C106 to set the voltage for full scale output.

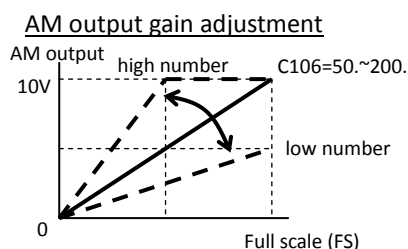
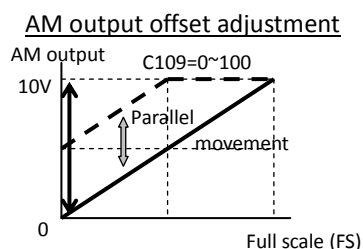

Note: In the case of use, please do the setting that had room not to be able to shake off a meter across the rating either in C028=01,02,04.

4.2.83 Initialization setting

The initialization function allows you to initialize the adjusted settings on the inverter to restore the factory settings. You can also clear the trip history data alone.

Related code
 b084: Initialization mode (parameters or trip history)
 b085: Country code for initialization

The settings of initialization are described below. Running-time data and power-on time data cannot be cleared.

Item	Function code	Data	Description
Initialization mode (parameters or trip history)	b084	00	Disabled
		01	Clearing on the trip history data
		02	Initializing only the settings The factory settings are restored.
		03	Clearing the trip history data and initializing the settings
		04	Clearing the trip history data and initializing the settings and EzSQ program
Country code for initialization	b085	00	Defaults intended for Japan
		01	Defaults intended for Europe
		02	Defaults intended for the U.S.A.

(Initializing procedure)

Adjust the above settings as required, and then perform the following procedure:

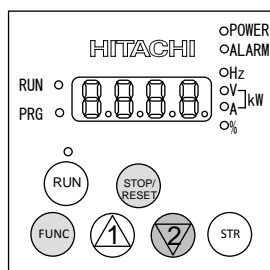

1) Set b180=01 and press the STR.

Or

Holding down the FUNC and [2] (down) keys, press and hold down the STOP/RESET key.

- After the monitor starts blinking, release only the STOP/RESET key. (The display on the monitor changes to that shown in the middle figure above.)
- Release the FUNC and [2] (down) keys.

Initialization-in-progress display intended for Europe

Initialization-in-progress display intended for the U.S.A.

Initialization-in-progress display for trip history clearance

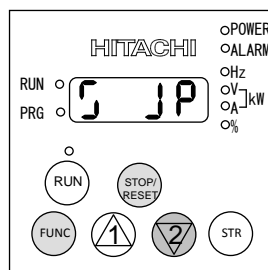

2) Initialization is in progress.

- The above figure shows the monitor display (indicating that the initialization is in progress) intended for Japan. Those intended for other regions and trip history clearance are shown below.

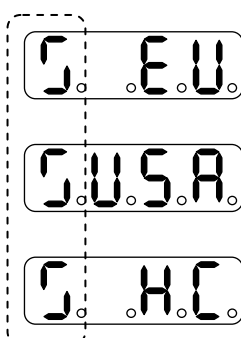

In the far-left digit, the lighting segments move round for about

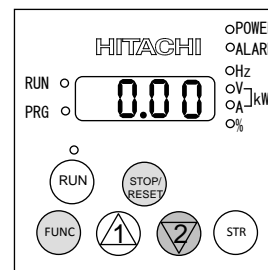

3) When the initialization is completed, the monitor displays data "0.00". (In case of b038 = 001) Confirm that the settings have been initialized.

Note 1: The initialization operation does not initialize the analog input settings (C081, C082, C083, C121, C122, and C123) and thermistor coefficient setting (C085).

Note 2: The initialization operation does not initialize the settings of easy sequence user parameters (P100 to P131).

4.2.84 Function code display restriction

The function code display restriction function allows you to arbitrarily switch the display mode or the display content on the digital operator.

Related code
b037: Function code display restriction
U001 to U012: User parameters

Item	Function code	Data	Description
Function code display restriction	b037	00	Full display
		01	Function-specific display
		02	User setting
		03	Data comparison display
		04	Basic display
User parameters	U001 to U012	no	No assignment
		d001 to P131	Selection of the code to be displayed (All codes are selectable.)

(1) Function-specific display mode

If a specific function has not been selected, the monitor does not display the parameters concerning the specific function.

The following table lists the details of display conditions:

No.	Display condition	Parameter displayed when the display condition is met
1	A001 = 01	A005, A006, A011 to A016, A101, A102, A111 to A114, C081 to C083, and C121 to C123
2	A001 = 10	A141 to A143
3	A002 = 01, 03, 04, or 05	b087
4	A017 = 01	d025 to d027, P100 to P131
5	A041 = 01	A046 and A047
6	A044 = 00 or 01	A041, A042 and A043
7	A044 = 03, 04 or 05	H002, H005, H050
8	A044 = 04	H060, H061
9	A = 03, 04, or 05 and H002 = 00	H020 to H024
10	A = 03, 04, or 05 and H002 = 01 or 02	H030 to H034
11	A044 and/or A244 = 03, 04, or 05	d008 to d010, d012, b040 to b046, H001, and H070 to H073
12	A044 and/or A244 = 02	b100 to b113
13	A051 = 01 or 02	A052 and A056 to A058
14	A051 = 01 or 02	A053 to A055, and A059
15	A071 = 01 or 02	d004, A005, A006, A011 to A016, A072 to A078, A101, A102, A111 to A114, C044, C052, C053, C081 to C083, and C121 to C123
16	A076 = 10	A141 to A143
17	A094 = 01 or 02	A095 and A096
18	A097 = 01, 02, 03 or 04	A131
19	A098 = 01, 02, 03 or 04	A132
20	b013, b213, and/or b313 = 02	b015 to b020
21	b021 = 01, 02 or 03	b022 and b023
22	b024 = 01, 02 or 03	b025 and b026
23	b050 = 01	b051 to b054
24	b095 = 01 or 02	b090 and b096
25	b098 = 01 or 02	b099 and C085
26	b120 = 01	b121 to b127

No.	Display condition	Parameter displayed when the display condition is met
27	One of C001 to C008 = 05 and A019 = 00	A028 to A035
28	One of C001 to C008 = 06	A038 and A039
29	One of C001 to C008 = 07	A053 to A055 and A059
30	One of C001 to C008 = 08	F202, F203, A203, A204, A220, A244, A246, A247, A261, A262, A292, A293, A294, b212, B213, H203, H204 and H206
31	One of C001 to C008 = 08 and A041 = 01	A246 and A247
32	One of C001 to C008 = 08 and A244 = 00 or 01	A241, A242 and A243
33	One of C001 to C008 = 08 and A244 = 03 or 04	H202, H205, H250, H251 and H252
34	One of C001 to C008 = 08 and A244 = 04	H260 and H261
35	One of C001 to C008 = 08, A244 = 03 or 04, and H202 = 00	H220 to H224
36	One of C001 to C008 = 08, A244 = 03 or 04, and H202 = 01 or 02	H230 to H234
37	One of C001 to C008 = 08 and A094 = 01 or 02	A295 and A296
38	One of C001 to C008 = 11	b088
39	One of C001 to C008 = 17	F302, F303, A303, A304, A320, A342, A343, A392, A393, b312, b313 and H306
40	One of C001 to C008 = 18	C102
41	One of C001 to C008 = 27, 28, or 29	C101
42	One of C021 to C008 = 03	C040 and C041
43	One of C021 to C008 = 26	C040 and C111
44	One of C021 to C008 = 02 or 06	C042 and C043
45	One of C021 to C008 = 07	C055 to C058
46	One of C021 to C008 = 21	C063
47	One of C021 to C008 = 24 or 25	C045 and C046
48	One of C021 to C008 = 33	C142 to C144
49	One of C021 to C008 = 34	C145 to C147
50	One of C021 to C008 = 35	C148 to C150
51	One of C021 to C008 = 36	C151 to C153
52	One of C021 to C008 = 37	C154 to C156
53	One of C021 to C008 = 38	C157 to C159
54	One of C021 to C008 = 42	C064

(2) User-setting display mode

The monitor displays only the codes and items that are arbitrarily assigned to user parameters (U001 to U012), except codes "d001", "F001", and "b037".

(3) Data comparison display mode

The monitor displays only the parameters that have been changed from the factory settings, except all monitoring indications (d***) and code "F001".

Note that the settings of input span calibration and input zero calibration (C081 to C083 and C121 to C123), and thermistor input tuning (C085) are not always displayed.

(4) Basic display mode

The monitor displays basic parameters. (The monitor display is the factory setting.)

The following table lists the parameters that can be displayed in basic display mode:

No.	Code displayed	Item
1	d001 to d104	Monitoring indication
2	F001	Output frequency setting
3	F002	Acceleration (1) time setting
4	F003	Deceleration (1) time setting
5	F004	Keypad Run key routing
6	A001	Frequency source setting
7	A002	Run command source setting
8	A003	Base frequency setting
9	A004	Maximum frequency setting
10	A005	[AT] selection
11	A020	Multispeed frequency setting
12	A021	Multispeed 1 setting
13	A022	Multispeed 2 setting
14	A023	Multispeed 3 setting
15	A044	V/F characteristic curve selection, 1st motor
16	A045	V/f gain setting
17	A085	Operation mode selection
18	b001	Selection of restart mode
19	b002	Allowable under-voltage power failure time
20	b008	Selection of retry after trip
21	b011	Retry wait time after trip
22	b037	Function code display restriction
23	b083	Carrier frequency setting
24	b084	Initialization mode (parameters or trip history)
25	b130	Overvoltage suppression enable
26	b131	Overvoltage suppression level
27	C021	Terminal [11] function
28	C022	Terminal [12] function
29	C036	Alarm relay active state

4.2.85 Initial-screen selection (selection of the initial screen to be displayed after power-on)

The initial-screen selection function allows you to specify the screen that is displayed on the digital operator immediately after the inverter power is turned on. The table below lists the screens (items) selectable. (The factory setting is "01" [d001].)

Related code
b038: Initial-screen selection

To adjust the screen selection setting of your SJ700 series inverter to an SJ300 series inverter, select "00" (the screen displayed when the STOP/RESET key was last pressed).

Item	Function code	Data	Description
Initial-screen selection	b038	00	Screen displayed when the STR key was pressed last (equivalent to the setting on SJ300)
		01	d001 (output frequency monitoring)
		02	d002 (output current monitoring)
		03	d003 (rotation direction monitoring)
		04	d007 (Scaled output frequency monitoring)
		05	F001 (output frequency setting)

Note: When "00" (the screen displayed when the STR key was last pressed) has been selected, the monitor displays code "*---" (entry to a group of functions) if the functional item displayed last is not "d****" or "F****".

(Example) If the inverter power is turned off immediately after the setting of "A020" has been changed, the monitor will display "A---" as the initial screen after the next power-on.

4.2.86 Automatic user-parameter setting

The automatic user-parameter setting function allows you to make the inverter automatically store the parameters you readjusted sequentially as user parameters "U001" to "U012". You can use the stored data as a readjustment history. To enable this function, select "01" (enabling automatic user-parameter setting) for the automatic user-parameter setting function enable (b039).

Related code
b039: Automatic user-parameter setting function enable
U001 to U012: User parameters

The setting data entered in (displayed on) the digital operator is stored when the STR key is pressed. Also the monitor screen code (d***) is stored at the same time.

User parameter "U001" retains the latest update of setting; user parameter "U012", the oldest update.

A functional parameter can be stored as only a single user parameter. After all the 12 user parameters have been used to store functional-parameter settings, new functional-parameter settings will be stored as user parameters on a first-in, first-out basis (that is, the next parameter will be written to "U012", storing the oldest update, first).

Item	Function code	Data	Description
Automatic user-parameter setting function enable	b039	00	Disabling automatic user
		01	Enabling automatic user

4.2.87 Stabilization constant setting

The stabilization constant setting function allows you to adjust the inverter to stabilize the motor operation when the motor operation is unstable.

Related code
H006/H206/H306: Motor stabilization constant, 1st/2nd/3rd motors
A045: V/f gain setting
b083: Carrier frequency setting

If the motor operation is unstable, check the motor capacity setting (H003/H203) and motor pole setting (H004/H204) to determine whether the settings match the motor specifications. If they do not match, readjust the settings. If the primary resistance of the motor is less than the standard motor specification, try to increase the setting of "H006/H206/H306" step by step. Try to reduce the setting of "H006/H206/H306" if the inverter is driving a motor of which the capacity is higher than the inverter rating.

You can also use the following methods to stabilize the motor operation:

- 1) Reducing the carrier frequency (b083) (See Section 4.2.11.)
- 2) Reducing the V/f gain setting (A045) (See Section 4.2.17.)

Item	Function code	Data	Description
Stabilization constant	H006/H206/H306	0. to 255.	Increase or reduce the setting to stabilize the motor.
V/f gain setting	A045	20. to 100. (%)	Reduce the setting to stabilize the motor.
Carrier frequency setting	b083	CT mode : 0.5 to 15.0 (kHz) <0.5 to 10.0(kHz)> VT mode : 0.5 to 12.0 (kHz) <0.5 to 8.0(kHz)>	Reduce the setting to stabilize the motor.

(note) <>:applied for 75 to 150kW

4.2.88 Selection of operation at option board error

You can select how the inverter operates when an error results from a built-in option board between two modes. In one mode, the inverter trips. In the other mode, the inverter ignores the error and continues the operation.

Related code
P001: Operation mode on expansion card 1 error
P002: Operation mode on expansion card 2 error

When you use the feedback option board (SJ-FB) as option board 1, specify "01" for "P001". When you use the SJ-FB as option board 2, specify "01" for "P002".

Item	Function code	Data	Description
Operation mode on expansion card 1 and 2 errors	P001/P002	00	TRP: Alarm output
		01	RUN: Continuation of operation

4.2.89 Optimum accel/decel operation function

The optimum accel/decel operation function eliminates the need for acceleration time and deceleration time settings for the motor operation by the inverter. Conventional inverters required you to adjust the acceleration and deceleration time according to the status of the load. Based on fuzzy logic, this function automatically adjusts the acceleration and deceleration time to

minimize the inverter performance. This function adjusts the acceleration time so that during acceleration, the inverter output current does not exceed the current level specified by the deceleration rate at overload restriction (when the overload restriction is enabled) or about 150% of the inverter's rated current (when the overload restriction is disabled). This function adjusts the deceleration time so that, during deceleration, the output current does not exceed about 150% of the inverter's rated current or the DC voltage in the inverter circuits does not exceed about 370 V (in the case of 200 V class models) or about 740 V (in the case of 400 V class models). Thus, this function automatically adjusts the acceleration and deceleration time appropriately on a real-time basis even when the motor load or the motor's moment of inertia changes.

Related code
A044/A244/A344: V/F characteristic curve selection, 1st/2nd/3rd motors
A085: Operation mode selection
b021/b024: Overload restriction operation mode (1) (2)
b022/b025: Overload restriction setting (1) (2)

Item	Function code	Data	Description
Operation mode selection	A085	00	Normal operation
		01	Energy-saving operation
		02	Fuzzy operation

Observe the following precautions and instructions when using this function:

- Note 1: This function is not suited for machines that require fixed acceleration and deceleration times. This function varies the acceleration and deceleration time according to the changes in the load and the moment of inertia.
- Note 2: If the inertial force produced in the machine becomes about 20 times as high as the motor shaft capacity, the inverter may trip. If this occurs, reduce the carrier frequency.
- Note 3: Even when the inverter is driving the same motor, the actual acceleration/deceleration time always changes according to current fluctuation.
- Note 4: The selection of the fuzzy acceleration/deceleration function is valid only when the control mode is a V/f characteristic control mode. When a sensorless vector control mode is selected, the selection of this function is ignored (normal operation is performed).
- Note 5: When the fuzzy acceleration/deceleration function is enabled, the jogging operation differs from the normal jogging operation because of fuzzy acceleration.
- Note 6: When the fuzzy acceleration/deceleration function is enabled, the deceleration time may be prolonged if the motor load exceeds the inverter's rated load.
- Note 7: If the inverter repeats acceleration and deceleration often, the inverter may trip.
- Note 8: Do not use the fuzzy acceleration/deceleration function when the internal regenerative braking circuit of the inverter or an external braking unit is used. In such cases, the braking resistor disables the inverter from stopping deceleration at the end of the deceleration time set by the fuzzy acceleration/deceleration function.
- Note 9: When using the inverter for a motor of which the capacity is one class lower than that of the inverter, enable the overload restriction function and set the overload restriction level to 1.5 times as high as the rated current of the motor.

4.2.90 Brake control function

The brake control function allows you to make the inverter control an external brake used for a lift or other machines. To enable this function, specify "01" (enabling the brake control function) for the Brake Control Enable (b120). This function operates as described below.

- 1) When the inverter receives an operation command, it starts the output and accelerates the motor up to the Brake Release Frequency Setting.
- 2) After the Brake Release Frequency Setting is reached, the inverter waits for the braking wait time (b121), and then outputs the brake release signal (BRK). However, if the inverter output current has not reached the brake release current (b126), the inverter does not output the brake release signal, but trips and outputs a braking error signal (BER).
- 3) When the braking confirmation signal (BOK) has been assigned to an intelligent input terminal (that is, when "44" is specified for one of "C001" to "C008"), the inverter waits for the Brake Wait Time for Confirmation (b124) without accelerating the motor after receiving the brake release signal. If the inverter does not receive the braking confirmation signal within the braking confirmation time (b124), it trips with the braking error signal (BER) output. When the braking confirmation signal (BOK) has not been assigned to any intelligent input terminal, the Brake Wait Time for Confirmation (b124) is invalid. In such cases, the inverter proceeds to the operation described in Item 4) after the output of the brake release signal.
- 4) After the input of the braking confirmation signal (or the output of the brake release signal [when the BOK signal function is disabled]), the inverter waits for the Brake Wait Time for Acceleration (b122), and then starts accelerating the motor up to the set acceleration frequency.
- 5) When the operation command is turned off, the inverter decelerates the motor down to the braking frequency (b125), and then turns off the brake release signal (BRK).
- 6) When the braking confirmation signal (BOK) has been assigned to an intelligent input terminal (that is, when "44" is specified for one of "C001" to "C008"), the inverter waits, after turning off the brake release signal, until the braking confirmation is turned off at least for the Brake Wait Time for Confirmation (b124) without decelerating the motor. If the braking confirmation signal is not turned off within the Brake Wait Time for Confirmation (b124), the inverter trips with the braking error signal (BER) output. When the braking confirmation signal (BOK) has not been assigned to any intelligent input terminal, the Brake Wait Time for Confirmation (b124) is invalid. In such cases, the inverter proceeds to the operation described in Item 7) after the brake release signal is turned off.
- 7) After the braking confirmation signal (or the brake release signal [when the BOK signal function is disabled]) is turned off, the inverter waits for the Brake Wait Time for Stopping (b123), and then starts decelerating the motor down to 0 Hz.

Related code

b120: Brake Control Enable
 b121: Brake Wait Time for Release
 b122: Brake Wait Time for Acceleration
 b123: Brake Wait Time for Stopping
 b124: Brake Wait Time for Confirmation
 b125: Brake Release Frequency Setting
 b126: Brake Release Current Setting
 b127: Braking frequency
 C001 to C008: Terminal [1] to [8] functions
 C021 to C025: Terminal [11] to [15] functions

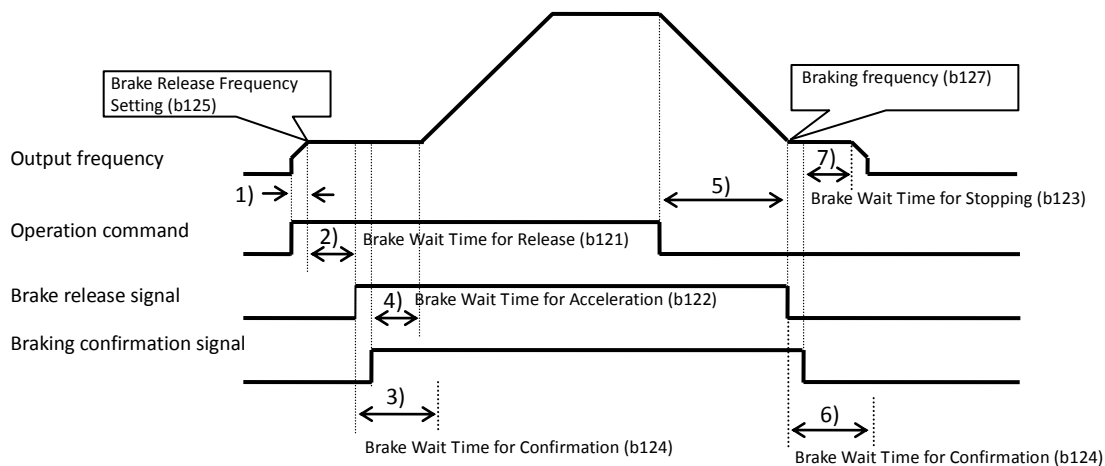

Note: The above timing chart shows the operation on the assumption that the braking confirmation signal "44" (BOK) is assigned to one of the terminal [1] to [8] functions (C001 to C008). If the BOK signal is not assigned to any terminal, the Brake Wait Time for Acceleration (b122) begins when the brake release signal is turned on, and the Brake Wait Time for Stopping (b123) begins when the brake release signal is turned off.

When using the brake control function, assign the following signal functions to intelligent input and intelligent output terminals as needed.

- (1) To input a signal indicating that the brake is released from the external brake to the inverter, assign the braking confirmation signal (44: BOK) to one of the terminal [1] to [8] functions (C001 to C008).
- (2) Assign the brake release signal (19: BRK), which is a brake-releasing command, to one of the intelligent output terminals [11] to [15] (C021 to C025). To output a signal when braking is abnormal, assign the brake error signal (20: BER) to an intelligent output terminal.

When using the brake control function, you are recommended to select the sensorless vector control (A044 = 03) 0Hz-range sensorless vector control (A044 = 04) or V2 (A044=05) as the V/F characteristic curve selection that ensures a high starting torque. (See Section 4.2.18.)

Settings required for the brake control function

Item	Function code	Data or range of data	Description
Brake Control Enable	b120	00	Disabling the brake control function
		01	Enabling the brake control function
Brake Wait Time for Release	b121	0.00 to 5.00 (s)	Time to wait after the output frequency has reached the release frequency until the output current reaches the release current
Brake Wait Time for Acceleration	b122	0.00 to 5.00 (s)	Mechanical delay after the release signal has been output until the brake is released
Brake Wait Time for Stopping	b123	0.00 to 5.00 (s)	Mechanical delay after the release signal has been turned off until the brake is applied
Brake Wait Time for Confirmation	b124	0.00 to 5.00 (s)	Wait time longer than the delay after the release signal output until the release completion signal output from the brake is input to the inverter
Brake Release Frequency Setting	b125	0.00 to 99.99 or 100.0 to 400.0 (Hz)	Frequency at which to output the brake release signal (*1)
Brake Release Current Setting	b126	0.00 to 2.00 x rated current (%) <0.00 to 1.80 x rated current (%)>	Frequency at which to permit brake releasing (*2) Only CT mode.
Braking frequency	b127	0.00 to 99.99 or 100.0 to 400.0 (Hz)	Frequency at which to apply the brake for stopping the motor (*1)

*1 Specify a frequency higher than the start frequency (b082).

*2 Note that setting a low current may not ensure sufficient torque at brake releasing.

*3 <>:applied for 75 to 150kW

The inverter will trip with the braking error signal (BER) (E36: brake error) output in one of the following cases:

- 1) The inverter output current brake remains below the brake release current, even after the release wait time (b121).
- 2) During acceleration, the braking confirmation signal (BOK) is not turned on within the braking wait time (b124). During deceleration, the braking confirmation signal (BOK) is not turned off within the braking wait time (b124). Otherwise, the braking confirmation signal is turned off although the brake release signal is output.

4.2.91 Deceleration and stopping at power failure (nonstop deceleration at instantaneous power failure)

The nonstop deceleration at instantaneous power failure is the function making the inverter decelerate and stop the motor while maintaining the voltage below the overvoltage level when an instantaneous power failure occurs during the inverter operation.

You can select three modes with controller deceleration and stop on power loss (b050).

Related code

b050: Controller deceleration and stop on power loss
 b051: DC bus voltage trigger level during power loss
 b052: Over-voltage threshold during power loss
 b053: Deceleration time setting during power loss
 b054: Initial output frequency decrease during power loss
 b055: Proportional gain setting for nonstop operation at momentary power failure
 b056: Integral time setting for nonstop operation at momentary power failure

Item	Function code	Data or range of data	Description
Controller deceleration and stop on power loss	b050	00	Disabling the nonstop deceleration function
		01	Enabling the nonstop deceleration function
		02	
		03	
DC bus voltage trigger level during power loss	b051	0.0 to 1000. (V)	
Over-voltage threshold during power loss (*1)	b052	0.0 to 1000. (V)	
Deceleration time setting during power loss	b053	0.01 to 3600. (s)	
Initial output frequency decrease during power loss	b054	0.00 to 10.00 (Hz)	
Proportional gain setting for nonstop operation at momentary power failure	b055	0.00 to 2.55	Proportional gain at DC voltage constant control(Only when "02" or "03" is specified for b050)
Integral time setting for nonstop operation at momentary power failure	b056	0.0 to 9.999 / 10.00 to 65.53	Integral time at DC voltage constant control(Only when "02" or "03" is specified for b050)

<1> nonstop deceleration at instantaneous power failure (b050=01)

- The nonstop deceleration at instantaneous power failure is the function making the inverter decelerate and stop the motor while maintaining the voltage below the overvoltage level (over-voltage threshold during power loss [b052]) when an instantaneous power failure occurs during the inverter operation.
- To use this function, remove the J51 connector cables from terminals R0 and T0, connect the main circuit terminals P and R0 to each other, and connect the main circuit terminals N and T0 to each other. Use 0.75 mm² or heavier wires for the connections.
- If an instantaneous power failure has occurred while the inverter is operating the motor and the output voltage falls to the DC bus voltage trigger level during power loss (b051) or less, the inverter reduces the output frequency by the initial output frequency decrease during power loss (b054) once, and then decelerates the motor for the deceleration time setting during power loss (b053).
- If the voltage increases to an overvoltage level (exceeding the over-voltage threshold during power loss [b052]) because of regeneration, the inverter enters the LAD stop state until the voltage falls below the overvoltage level.

Note1: If the over-voltage threshold during power loss (b052) is less than the DC bus voltage trigger level during power loss (b051), the over-voltage threshold during power loss will be increased to the DC bus voltage trigger level during power loss when the stop level is applied. (However, the stored setting will not be changed.)

And, in case b052 is less than the supply voltage (equivalent to rectified DC voltage which is square root 2 times supply AC voltage), when power recovers while this function is activated, inverter will be in the LAD stop status and cannot decelerate. (Stop command and frequency change command are not accepted until deceleration is completed). Be sure to set b052 more than the standard supply voltage.

Note2: This nonstop deceleration function cannot be canceled until the nonstop deceleration operation is completed. To restart the inverter operation after power recovery, wait until the inverter stops, enter a stop command, and then enter an operation command.

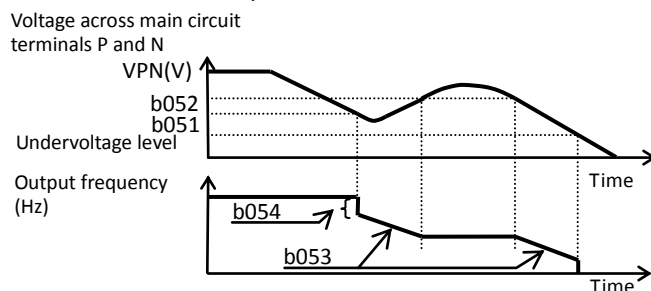

Note3: Setting higher initial output frequency decrease during power loss (b054) results in over current trip due to sudden deceleration.

Setting lower b054, or longer deceleration time during power loss (b053) results in undervoltage trip due to less regeneration power.

- <2> DC voltage constant control during nonstop operation at momentary power failure (b050 = 02: no restoration, b050 = 03: restoration to be done)
- If momentary power failure occurs or the main circuit DC voltage drops during inverter operation, the inverter decelerates the motor while maintaining the main circuit DC voltage at the level specified as the target nonstop operation voltage at momentary power failure (0V-LAD stop level) (b052).
- This function starts operating when all the following conditions are met:
 - "02" or "03" has been specified for b050.
 - The inverter is running. (This function does not operate if the inverter has been tripped, is in undervoltage status or stopped.)
 - The control power fails momentarily or the main circuit DC voltage drops to the DC bus voltage trigger level during power loss (b051) or less.
- This function operates when the conditions above are met even if the J51 connector cables have been disconnected from terminals R0 and T0, and cables are connected from main circuit terminal P to terminal R0, and from main circuit terminal N to terminal T0.
- If momentary power failure only lasts a short time, the inverter can continue operation without stopping its output. Conversely, if momentary power failure causes undervoltage, the inverter stops its output immediately and ends the operation of this function. When power is subsequently restored, the inverter operates according to the selection of restart mode (b001).
- When "03" is specified for b050, the inverter can be restored to normal operation if the input power is recovered from momentary power failure before the inverter stops its output. The inverter, however, may decelerate and stop the motor if a specific setting has been made for b051. The table below lists the differences in operation according to the setting of b051.

b050	b051	Operation
02 (No restoration)	b052 > Main circuit DC voltage at input power recovery	Decelerating and stopping the motor (DC voltage constant control) (Example 1)
	b052 < Main circuit DC voltage at input power recovery	Decelerating and stopping the motor (Example 2)
03 (Restoration to be done)	b052 > Main circuit DC voltage at input power recovery	Decelerating and stopping the motor (DC voltage constant control) (Example 1)
	b052 < Main circuit DC voltage at input power recovery	Decelerating and stopping the motor (Example 2)

- When this function operates and the inverter decelerates and stops the motor, the motor is forcibly stopped even if the FW signal is on. To restart the motor, turn on the FW signal again after confirming the recovery of inverter input power.
- Note 4: Each of the values of b051 and b052 must be the undervoltage 210V(200V class),410V(400V class)level or more. This function does not operate when undervoltage occurs. The value of b051 must be less than that of b052. When b051 is much higher proportional gain (b055) results in overcurrent by rapid acceleration after this function operates.
- Note 5: When "02" or "03" is specified for b050, PI control is performed so that the internal DC voltage is maintained at a constant level.
- Setting a higher proportional gain (b055) results in a faster response. However, an excessively high proportional gain causes the control to diverge and results in the inverter easily tripping.
- Setting a shorter integral time (b056) results in a faster response. However, an excessively short integral time results in the inverter easily tripping.
- Setting a lower proportional gain (b055) results in undervoltage trip due to a voltage drop immediately after starting this function.

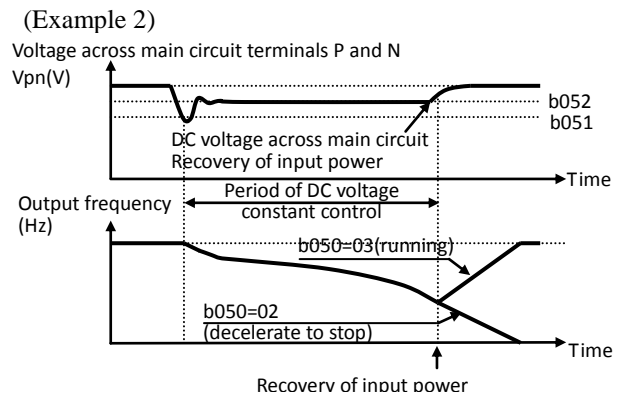
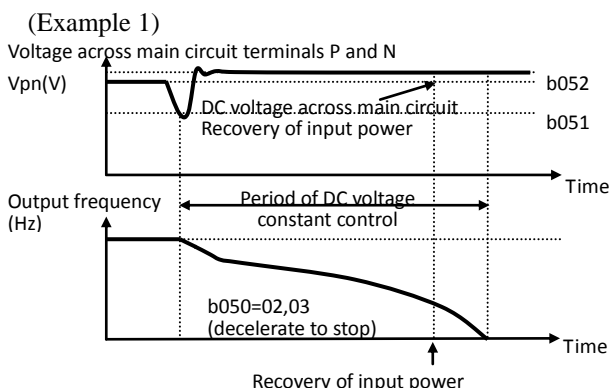

4.2.92 Offline auto-tuning function

The offline auto-tuning function allows you to make the inverter automatically measure and set the motor constants that are required for the sensorless vector control, 0Hz-range sensorless vector control, and vector control with sensor.

When using the inverter to perform the sensorless vector control, 0Hz-range sensorless vector control, and vector control with sensor for a motor of which the motor constants are unknown, measure the motor constants with the offline tuning function.

When "00" (Hitachi general-purpose motor data) is specified for the motor constant selection (H002/H202), the motor constants of Hitachi's general-purpose motors are set as defaults. When you drive a Hitachi's general-purpose motor with the inverter, you can usually obtain the desired motor characteristics without problems. (If you cannot obtain the desired characteristics, adjust the motor constant settings as described in Section 4.2.92 or 4.2.93.)

If you intend to use the online tuning function described later, be sure to perform offline auto-tuning beforehand. The offline auto-tuning function applies only to the 1st motor and 2nd motor controls. Do not apply this function to the 3rd motor control.

The motor constant data corresponding to the date of one phase of γ connection at 50 Hz.

You should use off-line auto-tuning first by using factory default settings as long as you can .

(There are some unusable functions and settings when using off line auto-tuning. Please see the following notices in detail.)

Related code

H001: Auto-tuning Setting
 H002/H202: Motor data selection, 1st motor
 H003/H203: Motor capacity, 1st motor
 H004/H204: Motor poles setting, 1st motor
 H030/H230: Auto constant R1, 1st/2nd motor
 H031/H231: Auto constant R2, 1st/2nd motor
 H032/H232: Auto constant L, 1st/2nd motor
 H033/H233: Auto constant I_o, 1st/2nd motor
 H034/H234: Auto constant J, 1st/2nd motor
 A003/A203: Base frequency setting
 A051: DC braking selection
 A082: AVR voltage select
 b046: Reverse run protection enable

Item	Function code	Data or range of data	Description
Auto-tuning Setting	H001	00	Disabling the auto-tuning
		01	Enabling the auto-tuning (without motor rotation)
		02	Enabling the auto-tuning (with motor rotation)
Motor data selection	H002/H202	00	Hitachi general-purpose motor data
		01	Automatically tuned data
		02	Automatically tuned data (online auto-tuning enabled)
Motor capacity	H003/H203	0.2 to 75.0 (kW) <0.2 to 160(kW)>	Note)<>:applied for 75 to 150kW
Motor poles setting	H004/H204	2, 4, 6, 8, or 10 (poles)	
Auto constant R1	H030/H230	0.000 to 65.53 (Ω)	
Auto constant R2	H031/H231	0.000 to 65.53 (Ω)	
Auto constant L	H032/H232	0.00 to 655.3 (mH)	
Auto constant I _o	H033/H233	0.00 to 655.3 (A)	
Auto constant J	H034/H234	0.001 to 9999. (kgm ²)	
Base frequency setting	A003/A203	30 to maximum frequency setting (Hz)	
DC braking enable	A051	00	Disabling DC braking
		01	Enabling DC braking
AVR voltage select	A082	200, 215, 220, 230, or 240	Selectable only for 200 V class models
		380, 400, 415, 440, 460, or 480	Selectable only for 400 V class models

When using this function, follow the instructions below.

- Adjust the settings of base frequency (A003) and AVR voltage select (A082) to the motor specifications. When motor voltage is other than the alternatives, set as "motor voltage (A082) " * "output voltage gain (A045) " = "motor rated voltage" Please set 00 (constant torque characteristic[VC]) to V/F control mode(A044), and do not set free V/F setting(02). If you set free V/F setting (A044), auto-tuning function does not work.(see note 6)
- This function can properly apply to only the motors in the maximum applicable capacity class of your inverter or one class lower than the capacity class of your inverter. If this function is used for motors with other capacities, correct constant data may not be obtained. (In such cases, the auto-tuning operation may not be completed. If the auto-tuning operation is not completed, press the STOP/RESET key. The operation will end with an error code displayed.)
- If "01" (enabling) is specified for the DC braking enable (A051), motor constants cannot be measured by offline auto-tuning. Specify "00" (disabling) for the DC braking enable. (The default setting is "00".)
- If "02" (auto-tuning with motor rotation) is specified for the Auto-tuning Setting (H001), confirm or observe the following:
 - No problem occurs when the motor rotates at a speed close to 80% of the base frequency.
 - The motor is not driven by any other external power source.
 - All brakes are released.
 - During auto-tuning, insufficient torque may cause a problem in the load driven by the motor (for example, a lift may slide down). Therefore, remove the motor from the machine or other load, and perform auto-tuning with the motor alone. (The moment of inertia [J] measured by auto-tuning is that of the motor alone. To apply the data, add the moment of inertia of the

load machine to the measured J data after converting the moment of inertia into the motor shaft data.)

- e) If the motor is installed in a machine (e.g., lift or boring machine) that limits the motor shaft rotation, the allowable rotation limit may be exceeded during auto-tuning, and the machine may be damaged. To avoid this problem, specify "01" (auto-tuning without motor rotation) for the Auto-tuning Setting (H001).
 - f) If the no-load current is unknown, operate the motor at 50 Hz in a V/f characteristic control mode to measure the motor current with current monitor. Then, set the measured current as the control constant "H023" or "H223" before auto-tuning.
- 5) Even when "01" (auto-tuning without motor rotation) is specified for the Auto-tuning Setting (H001), the motor may rotate slightly during auto-tuning.
- 6) When performing the auto-tuning for a motor of which the capacity is one class lower than that of the inverter, enable the overload restriction function, and set the overload restriction level to 1.5 times as high as the rated current of the motor.

Operating procedure

1) Specify "01" or "02" for the Auto-tuning Setting (H001). It is recommended to use keypad as a source of run command (A002). If you turn on the run command or turn off during auto-tuning, auto-tuning will get terminated abnormally. (see note 5)

2) Input an operation command.

When the operation command is input, the inverter performs an automatic operation in the following steps:

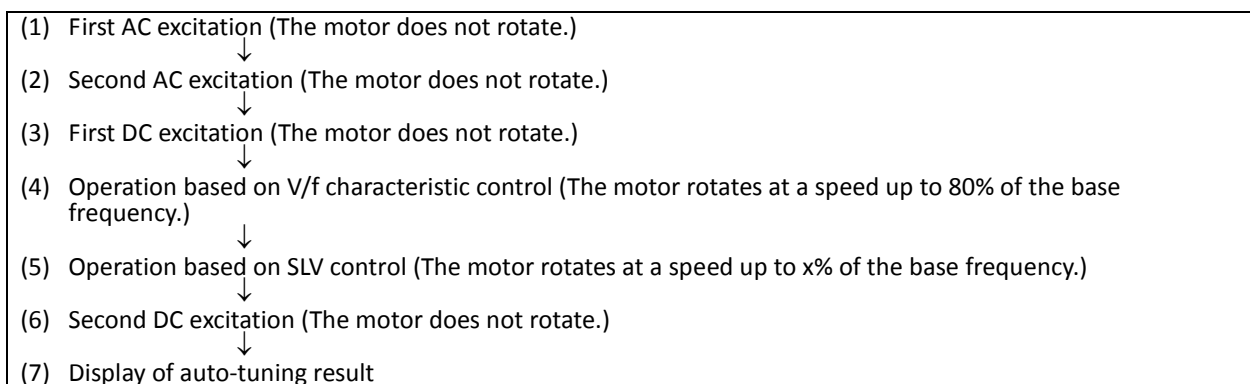

Note 1: Steps (4) and (5) are skipped when the auto-tuning without motor rotation (H001 = 01) has been selected.

Note 2: The motor speed (x) in step (5) is as follows. Assume that "T" is the acceleration or deceleration time in step (4), whichever is largest.

When $0s \leq T < 50s$, $x = 40\%$.

When $50s \leq T < 100s$, $x = 20\%$.

When $100s \leq T$, $x = 10\%$.

Note 3: The tuning result is displayed as follows:



If the auto-tuning has ended abnormally, retry it.

(To clear the result display, press the STOP/RESET key.)

Note 4: If the inverter trips during the auto-tuning, the auto-tuning is terminated forcibly.

(In such cases, the monitor does not display the abnormal-end code, but displays a trip indication code.)

In such cases, remove the cause of tripping, and then set H001=01 again to retry the auto-tuning after turning off power source for the inverter and turn on.

Note 5: If you cancel the auto-tuning midway with a stop command (by pressing the STOP/RESET key or turning off the operation command), the constants set for auto-tuning may remain in the inverter.

Before retrying the auto-tuning, initialize the inverter, and then readjust the settings for the auto-tuning.

(Perform the same procedure also when you proceed to the normal inverter operation.)

Before retrying the auto-tuning, initialize the setting parameters of inverter or turn off power source for the inverter and turn on. And then readjust the settings for the auto-tuning. (Perform the same procedure also when you proceed to the normal inverter operation.)

Note 6: If an attempt is made to perform the auto-tuning with a free V/f characteristic selected as the control mode, the inverter will soon terminate the operation with the abnormal-end code displayed.

Note 7: Even if the auto-tuning has ended normally, you cannot operate the inverter with the tuning data left. If you intend to operate the inverter with the tuning data left, be sure to switch the setting of motor constant selection (H002) to "01".

Note 8: You should not activate any functions set on intelligent terminals 1-8 during auto-tuning. (Set normal open terminals off, and set normal close terminals on). The working functions on the intelligent terminals cause abnormal termination. The motor might keep running without run command in this case. Please restart auto-tuning after turning off power source for the inverter and turn on again.

Note 9: Do not use DC braking. You should set DC-braking selection (A051) invalid for

auto-tuning.

Note10: Do not start auto-tuning with setting servo-on(54:SON)and forcing function(55:FOC) to the intelligent terminals. You should remove these functions and start auto-tuning in this case. Please set these functions after normal termination of auto-tuning and confirming good motor rotation.

Note11: If you set control mode(A044) to vector control with sensor(05),you should not set V2 control mode(P012) to position control mode(01:APR,02:APR2,03:HAPR).Do not also use torque control ,torque bias control. You should use these functions after normal termination of auto-tuning and confirming good motor rotation.

Note 12: If auto-tuning has finished , once turn off power source of inverter and turn on.

4.2.93 Online auto-tuning function

The online auto-tuning function allows you to compensate the motor constants for alterations caused by the rise of motor temperature and other factors to ensure stable motor operation.

The online auto-tuning function applies only to the 1st motor and 2nd motor controls. Do not apply this function to the 3rd motor control.

Item	Function code	Data	Description
Motor constant selection	H002/H202	00	Hitachi general-purpose motor data
		01	Automatically tuned data
		02	Automatically tuned data (online auto-tuning enabled)

When using this function, follow the instructions below.

- 1) Be sure to perform the offline auto-tuning before the online auto-tuning.
- 2) Since the data for online tuning is calculated by the offline auto-tuning, perform the offline tuning at least once, even when the inverter is used to drive a Hitachi general-purpose motor.
- 3) The online auto-tuning operates for a maximum of 5 seconds after the motor has stopped. (DC excitation is executed once to tune constants R1 and R2. The result of tuning is not reflected in the data displayed on the monitor.) If an operation command is input during the auto-tuning operation, the online auto-tuning ends midway because the operation command has priority over the online auto-tuning. (In such cases, the result of tuning is not reflected in the inverter settings.)
- 4) When the DC braking at stopping has been specified, the online tuning is performed after the DC braking operation ends.
- 5) When FOC, SON terminals are assigned, online auto-tuning is not executed.

Operating procedure

- 1) Specify "02" (enabling the online auto-tuning) for the motor constant selection "H002". (Specify "00" [disabling the auto-tuning] for the Auto-tuning Setting "H001".)
- 2) Input an operation command. (The inverter will automatically perform the online auto-tuning after the motor stops.)

4.2.94 Secondary resistance compensation (temperature compensation) function

The secondary resistance compensation function allows you to compensate for the secondary resistance to control the motor speed fluctuations due to the changes in the motor temperature. This function can operate when the control mode is the sensorless vector control, 0Hz-range sensorless vector control, or vector control with sensor.

(Use the thermistor model PB-41E made by Shibaura Electronics Corporation.)

When using this function, specify "02" (NTC) for the thermistor for thermal protection control (b098). (With a thermistor other than the PB-41E or another setting of the thermistor for thermal protection control, the motor temperature cannot be detected correctly.)

Related code
P025: Temperature compensation thermistor enable
b098: Thermistor for thermal protection control

Item	Function code	Data	Description
Temperature compensation thermistor enable	P025	00	Disabling the secondary resistance compensation
		01	Enabling the secondary resistance compensation

4.2.95 Motor constants selection

Adjust the motor constant settings to the motor to be driven by the inverter.

When using a single inverter to drive multiple motors in the control mode based on VC, VP, or free V/f characteristic, calculate the total capacity of the motors, and specify a value close to the total capacity for the motor capacity selection (H003/H203).

When the automatic torque boost function is used, the motor constant settings that do not match the motor may result in a reduced motor or unstable motor operation.

You can select the motor constants that are used when the control mode is the sensorless vector control, 0Hz-range sensorless vector control, or vector control with sensor from the following three types:

(1) Motor constants of Hitachi general-purpose motor

(2) Motor constants tuned by offline auto-tuning

(3) Arbitrarily set motor constants

The motor constants set for the 1st motor control apply to the 3rd motor control.

Item	Function code	Data or range of data	Description
V/F characteristic curve selection	A044/A244/ A344	00	Constant torque characteristic (VC)
		01	Reduced-torque characteristic (1.7th power of VP)
		02 (*1)	Free V/f characteristic
		03 (*1)	Sensorless vector control (SLV)
		04 (*1)	0 Hz-range sensorless vector control
		05 (*1)	Vector control with sensor (V2)
Motor data selection	H002/H202	00	Hitachi general-purpose motor constants
		01	Motor constants tuned by auto-tuning
		02	Motor constants tuned by online auto-tuning
Motor capacity	H003/H203	0.2 to 75.0 (kW) <0.2 to 150(kW)>	Note)<>applied for 75 to 150kW
Motor poles setting	H004/H204	2, 4, 6, 8, or 10 (poles)	
Motor constant R1	H020/H220	0.000 to 65.53 (Ω)	(*2)
Motor constant R2	H021/H221	0.000 to 65.53 (Ω)	(*2)
Motor constant L	H022/H222	0.00 to 655.3 (mH)	
Motor constant I _o	H023/H223	0.00 to 655.3 (A)	(*2)
Motor constant J	H024/H224	0.001 to 9999. (kgm ²)	(*3)
Auto constant R1	H030/H230	0.000 to 65.53 (Ω)	
Auto constant R2	H031/H231	0.000 to 65.53 (Ω)	
Auto constant L	H032/H232	0.00 to 655.3 (mH)	
Auto constant I _o	H033/H233	0.00 to 655.3 (A)	
Auto constant J	H034/H234	0.001 to 9999. (kgm ²)	

*1 Any of "00" to "05" can be selected for the 1st motor (A044). Only "00" to "04" can be selected for the 2nd motor (A244). Only "00" or "01" can be selected for the 3rd motor (A344).

*2 If you copy the data from a J300 series inverter to your SJ700 series inverter, set constants R1, R2, and I_o as follows:
 $R1_{SJ700} = R1_{J300}/1.125$ $R2_{SJ700} = R2_{J300}/1.2$ $I_o = V/\{272 \times (2 \times M_{J300} + L_{J300}) \times 10^{-3}\}$
V: Voltage class (200 or 400 V)

*3 Convert the moment of inertia (J) into the motor shaft data. When the value of J is large, the motor response is fast, and the motor torque increases quickly. When the value of J is small, the motor response is slow, and the motor torque increases slowly. To control the response, set the value of J, and then adjust the speed response (H005/H205).

*4 In the modes of sensorless vector control, 0Hz-range sensorless vector control and vector control with sensor, inverter may output reverse to given operation command in the low speed range as a nature of those control. In case there is a specific inconvenience for example reverse rotation damage the machine, enable the reverse run protection (b046). (see 4.2.101: Reverse run protection function)

Arbitrary setting of motor constants

For the arbitrary setting of the motor constants, the function codes requiring settings vary depending on the settings of the 1st/2nd control function and the motor constant selection.

- When the 1st/2nd control function is enabled and "00" is specified for the motor constant selection → Directly input the desired values for "H020" to "H024".
- When the 1st/2nd control function is enabled and "01" or "02" is specified for the motor constant selection → Directly input the desired values for "H030" to "H034".

When the offline auto-tuning has not been performed, the constants (Hitachi general-purpose motor constants) of the motors in the same capacity class as the inverter have been set for "H030/H230" to "H034/H234".

4.2.96 Sensorless vector control

The sensorless vector control function estimates and controls the motor speed and output torque on the basis of the inverter output voltage and output current and the motor constants set on the inverter. This function enables the inverter to accurately operate the motor with a high starting torque, even at a low frequency (0.3 Hz or more).

To use this function, specify "03" for the V/F characteristic curve selection (A044/A244).

Before using this function, be sure to make optimum constant settings for the motor with reference to Section 4.2.91, "Motor constant selection."

When using this function, observe the following precautions:

- 1) If you use the inverter to drive a motor of which the capacity is two classes lower than the maximum applicable capacity of the inverter, you may not be able to obtain adequate motor characteristics.
- 2) If you cannot obtain the desired characteristics from the motor driven under the sensorless vector control, readjust the motor constants according to the symptom, as described in the table below.

Related code

A001: Frequency source setting
 A044/A244: V/F characteristic curve selection, 1st/2nd motors
 F001: Output frequency setting
 b040: Torque limit selection
 b041 to b044: Torque limits (1) to (4)
 H002/H202: Motor data selection, 1st/2nd motors
 H003/H203: Motor capacity, 1st/2nd motors
 H004/H204: Motor poles setting, 1st/2nd motors
 H005/H205: Motor speed constant, 1st/2nd motors
 H020/H220: Motor constant R1, 1st/2nd motors
 H021/H221: Motor constant R2, 1st/2nd motors
 H022/H222: Motor constant L, 1st/2nd motors
 H023/H223: Motor constant I_o, 1st/2nd motors
 H024/H224: Motor constant J, 1st/2nd motors
 H050/H250: PI proportional gain, 1st/2nd motors
 H051/H251: PI integral gain, 1st/2nd motors
 H052/H252: P proportional gain setting, 1st/2nd motors

Operation status	Symptom	Adjustment method	Adjustment item
Powering	Momentary speed variation is negative.	Increase the motor constant R2 step by step from the set value up to 1.2 times as high as the set value.	H021/H221/H031
	Momentary speed variation is positive.	Reduce the motor constant R2 step by step from the set value down to 0.8 times as high as the set value.	H021/H221/H031
Regenerating	Torque is insufficient at low frequencies (several Hz)	Increase the motor constant R1 step by step from the set value up to 1.2 times as high as the set value.	H020/H220/H030
		Increase the motor constant I _o step by step from the set value up to 1.2 times as high as the set value.	H023/H223/H033
Starting	The motor generates an impact when it starts.	Reduce the motor constant J from the set value.	H024/H224/H034
Decelerating	The motor runs unsteadily.	Reduce the speed response setting.	H005/H205
		Reduce the motor constant J from the set value.	H024/H224/H034
Torque-limited operation	Torque is insufficient during torque-limited operation at a low frequency.	Reduce the overload restriction level to lower than the torque limiter level.	b021, b041 to b044
Low-frequency operation	Motor rotation is inconsistent.	Increase the motor constant J from the set value.	H024/H224/H034
starting	Motor runs backwards for short moment.	Set 01 (enable) on reverse run protection function (b046)	b046

Note 1: Always set the carrier frequency (b083) to 2.1 kHz or more. If the carrier frequency is less than 2.1 kHz, the inverter cannot operate the motor normally.

Note 2: When driving a motor of which the capacity is one class lower than the inverter, adjust the torque limit (b041 to b044) so that the value "α" calculated by the expression below does not exceed 200%. Otherwise, the motor may be burnt out.

$$\alpha = \text{"torque limit"} \times (\text{inverter capacity}) / (\text{motor capacity})$$

(Example) When the inverter capacity is 0.75 kW and the motor capacity is 0.4 kW, the torque limit value is calculated as follows, based on the assumption that the value "α" should be 200%:

$$\text{Torque limit (b041 to b044)} = \alpha \times (\text{motor capacity}) / (\text{inverter capacity}) = 200\% \times (0.4 \text{ kW}) / (0.75 \text{ kW}) = 106\%$$

4.2.97 Sensorless vector, 0 Hz domain control

The 0Hz domain sensorless vector (SLV) control function incorporates Hitachi's own torque control system and enables high-torque operation in the 0Hz range (0 to 3 Hz). This control function is best suited for driving a lifting machine, e.g., crane or hoist, that requires sufficient torque when starting at a low frequency.

To use this function, specify "04" for the V/F characteristic curve selection (A044/A244).

Before using this function, be sure to optimize constant settings for the motor with reference to Section 4.2.91, "Motor constant selection."

The parameters related to the 0Hz-range sensorless vector control are as follows:

1) The Zero LV limit for 1st/2nd motors (H060/H260) is the parameter that specifies the output current for the constant-current control in the 0 Hz range (about 3.0 Hz or less).

The parameter value is expressed as a ratio of the output current to the inverter's rated current.

2) The Zero LV starting boost current (H061/H261) is the parameter to specify the current for boosting at motor start-up with a frequency in the 0 Hz range. The parameter value is expressed as a ratio of the boost current to the inverter's rated current. The value of the boost current is added to the current value specified by "H060/H260" only at starting.

Related code

A001: Frequency source setting
 A044/A244: V/F characteristic curve selection, 1st/2nd motors
 F001: Output frequency setting
 b040: Torque limit selection
 b041 to b044: Torque limit (1) to (4)
 H002/H202: Motor data selection, 1st/2nd motors
 H003/H203: Motor capacity, 1st/2nd motors
 H004/H204: Motor poles setting, 1st/2nd motors
 H005/H205: Motor speed constant, 1st/2nd motors
 H020/H220: Motor constant R1, 1st/2nd motors
 H021/H221: Motor constant R2, 1st/2nd motors
 H022/H222: Motor constant L, 1st/2nd motors
 H023/H223: Motor constant I0, 1st/2nd motors
 H024/H224: Motor constant J, 1st/2nd motors
 H050/H250: PI proportional gain, 1st/2nd motors
 H051/H251: PI integral gain, 1st/2nd motors
 H052/H252: P proportional gain setting, 1st/2nd motors
 H060/H260: Zero LV limit, 1st/2nd motors
 H061/H261: Zero LV starting boost current, 1st/2nd motors

Item	Function code	Range of data	Description
Zero LV limit	H060/H260	0.0 to 100.0 (%)	Current limiter for the low-speed range
Zero LV starting boost current	H061/H261	0. to 50. (%)	Quantity of boost current at starting

When using this function, observe the following precautions:

- 1) Be sure to use an inverter of which the capacity is one class higher than the motor to be driven.
- 2) If you use the inverter to drive a motor of which the capacity is two classes lower than the maximum applicable capacity of the inverter, you may not be able to obtain adequate motor characteristics.
- 3) If you cannot obtain desired characteristics from the motor driven under the 0Hz-range sensorless vector control, readjust the motor constants according to the symptom as described in the table below.

Operation status	Symptom	Adjustment method	Adjustment item
Powering	Momentary speed variation is negative.	Increase the motor constant R2 step by step from the set value up to 1.2 times as high as the set value.	H021/H221/H031
	Momentary speed variation is positive.	Reduce the motor constant R2 step by step from the set value down to 0.8 times as high as the set value.	H021/H221/H031
Regenerating	Torque is insufficient at low frequencies (several Hz)	Increase the motor constant R1 step by step from the set value up to 1.2 times as high as the set value.	H020/H220/H030
		Increase the motor constant I0 step by step from the set value up to 1.2 times as high as the set value.	H023/H223/H033
Starting	The motor generates an impact when it starts.	Reduce the motor constant J from the set value.	H024/H224/H034
Decelerating	The motor runs unsteadily.	Reduce the speed response setting.	H005/H205
		Reduce the motor constant J from the set value.	H024/H224/H034
Immediately after deceleration	Overcurrent or overvoltage protection function operates.	Reduce the motor constant I0 step by step from the set value down to 0.8 times as high as the set value.	H023/H223/H033
		Specify "00" (always on) or "01" (always off) for the AVR function select (A081).	A081
Low-frequency operation	Motor rotation is inconsistent.	Increase the motor constant J from the set value.	H024/H224/H034

Note 1: Always set the carrier frequency (b083) to 2.1 kHz or more. If the carrier frequency is less than 2.1 kHz, the inverter cannot operate the motor normally.

Note 2: Adjust the torque limit (b041 to b044) so that the value " α " calculated by the expression below does not exceed 200%. Otherwise, the motor may be burnt out.

$$\alpha = \text{"torque limit"} \times (\text{inverter capacity}) / (\text{motor capacity})$$

(Example) When the inverter capacity is 0.75 kW and the motor capacity is 0.4 kW, the torque limit value is calculated as follows on the assumption that the value " α " should be 200%:

$$\text{Torque limit (b041 to b044)} = \alpha \times (\text{motor capacity}) / (\text{inverter capacity}) = 200\% \times (0.4 \text{ kW}) / (0.75 \text{ kW}) = 106\%$$

4.2.98 Torque monitoring function

The torque monitoring function allows you to monitor the estimated motor output torque when the V/F characteristic curve selection is the sensorless vector control, 0Hz-range sensorless vector control, or vector control with sensor.

To monitor the output torque on the digital operator, select code "d012" on the digital operator.

To monitor the output torque as a signal output from the control circuit terminal block, see Section 4.2.77, "FM terminal," or 4.2.78, "AM and AMI terminals."

If the constant torque characteristic (VC), reduced-torque characteristic (1.7th power of VP), or free V/f characteristic is specified for the V/F characteristic curve selection (A044/A244), this function is disabled, and the display on the digital operator and the signal output from the control circuit terminal block are unpredictable.

The torque monitored by this function is displayed as a ratio to the torque the motor outputs when rotating in synchronization with the frequency corresponding to the motor's rated output. (The latter torque is 100%.)

Since this function estimates the output torque from the motor current, the accuracy of monitoring is about 20% when the inverter drives a motor that has the same output ratings as the inverter.

Related code

A044/A244: V/F characteristic curve selection, 1st/2nd motors
 C027: [FM] signal selection
 C028: [AM] signal selection
 C029: [AMI] signal selection
 H003/H203: Motor capacity, 1st/2nd motor
 H004/H204: Motor poles setting, 1st/2nd motors

Item	Function code	Data or range of data	Description
V/F characteristic curve selection	A044/A244	03	Sensorless vector control
		04	0Hz-range sensorless vector control
		05	Vector control with sensor (not available for A244)
[FM] signal selection	C027	02	Output torque
[AM] signal selection	C028	11	Output torque (signed) (only for C028)
[AMI] signal selection	C029		
Motor capacity selection	H003/H203	0.20 to 75.0 (kW) <0.2 to 160(kW)>	
Motor pole selection	H004/H204	2, 4, 6, 8, or 10 (poles)	

(NOTE) <>:applied for 75 to 150kW

4.2.99 Forcing function (FOC)

The forcing function allows you to apply an exciting current via an input terminal to the inverter to pre-build magnetic flux when "03" (sensorless vector control), "04" (0Hz-range sensorless vector control), or "05" (vector control with sensor) is specified for the V/F characteristic curve selection (A044/A244).

To use this function, assign function "55" (FOC) to an intelligent input terminal.

After the FOC function is assigned, the inverter will accept operation commands only when the FOC terminal is turned on.

If the FOC terminal is turned off while the inverter is operating the motor, the inverter sets the motor into the free-running state. If the FOC terminal is turned on subsequently, the inverter restarts the motor according to the setting of the restart mode after FRS (b088).

Related code

A044/A244: V/F characteristic curve selection, 1st/2nd motors
 C001 to C008: Terminal [1] to [8] functions

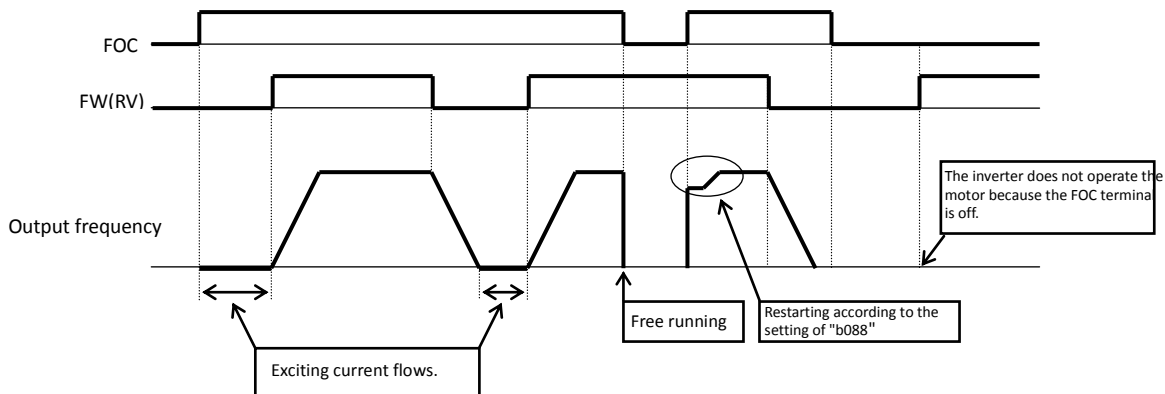

4.2.100 Torque limitation function

The torque limitation function allows you to limit the motor output torque when "03" (sensorless vector control), "04" (0Hz-range sensorless vector control), or "05" (vector control with sensor) is specified for the V/F characteristic curve selection (A044/A244).

You can select one of the following four torque limitation modes with the torque limit selection (b040):

- 1) Quadrant-specific setting mode
In this mode, individual torque limit values to be applied to four quadrants (i.e. forward powering, reverse regeneration, reverse powering, and forward regeneration) are set as the torque limits 1 to 4 (b041 to b044), respectively.
- 2) Terminal-switching mode
In this mode, the torque limit values set in the torque limits 1 to 4 (b041 to b044) are switched from one another according to the combination of the states of torque limit switch terminals 1 and 2 (TRQ1 and TRQ2) assigned to intelligent input terminals. A single selected torque limit is valid in all operating states of the inverter.
- 3) Analog input mode
In this mode, a torque limit value is set by a voltage applied to the control circuit terminal O2. The voltage range 0 to 10 V corresponds to the torque limit value range 0 to 200%. A single selected torque limit is valid in all operating states of the inverter.
- 4) Option (option 1/2) mode
This mode is valid when the option board (SJ-DG) is used. For details on this mode, refer to the instruction manual for the option board.

If function "40" (TL: whether to enable torque limitation) has been assigned to an intelligent input terminal, the torque limitation mode selected by the setting of "b040" is enabled only when the TL terminal is turned on. When the TL terminal is off, torque limit settings are invalid, and the maximum torque setting is applied as a torque limit. If the TL function has not been assigned to any intelligent input terminal, the torque limitation mode selected by the setting of "b040" is always enabled.

Each torque limit value used for this function is expressed as a ratio of the maximum torque generated when the inverter outputs its maximum current on the assumption that the maximum torque is 200%. Note that each torque limit value does not represent an absolute value of torque. The actual output torque varies depending on the motor.

If the torque limited (TRQ) signal function is assigned to an intelligent output terminal, the TRQ signal will turn on when the torque limitation function operates.

Related code

A044/A244: V/F characteristic curve selection, 1st/2nd motors
b040: Torque limit selection
b041 to b044: Torque limits (1) to (4)
C001 to C008: Terminal [1] to [8] functions
C021 to C025: Terminal [11] to [15] functions

Item	Function code	Data or range of data	Description
V/F characteristic curve selection	A044/A244	03	Sensorless vector control
		04	0Hz-range sensorless vector control
		05	Vector control with sensor (not available for A244)
Torque limit selection	b040	00	Quadrant-specific setting mode
		01	Terminal-switching mode
		02	Analog input mode
		03	Option 1 mode
		04	Option 2 mode
Torque limit (1)	b041	CT mode: 0 to 200 (%) <0 to 180(> VT mode: 0 to 150 (%) <0 to 150(>	Forward powering (in quadrant-specific setting mode)
Torque limit (2)	b042		Reverse regeneration (in quadrant-specific setting mode)
Torque limit (3)	b043		Reverse powering (in quadrant-specific setting mode)
Torque limit (4)	b044		Forward regeneration (in quadrant-specific setting mode)
Terminal function	C001 to C008	40	Whether to enable torque limitation
		41	Torque limit switch 1
		42	Torque limit switch 2
Terminal function	C021 to C025	10	Torque limited signal

(NOTE) <>:applied for 75 to 150kW

When "00" (quadrant-specific setting mode) is specified for the torque limit selection (b040), the torque limits 1 to 4 apply as shown below.

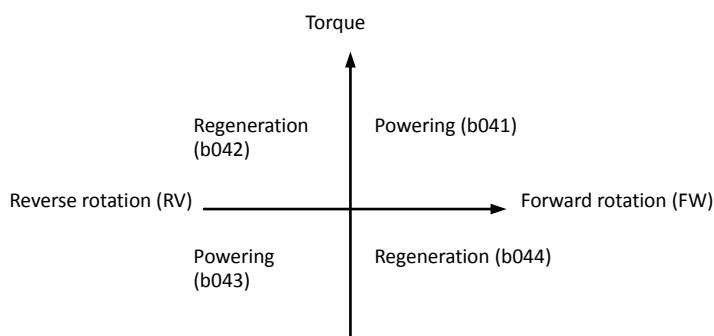

When "01" (terminal-switching mode) is specified for the torque limit selection (b040), the torque limits 1 to 4 are set as shown in the example below. The torque limits 1 to 4 are switched by the torque limit switches 1 and 2 assigned to intelligent input terminals.

(Example) When torque limit switch 1 (41) and torque limit switch 2 (42) are assigned to intelligent input terminals [7] and [8], respectively:

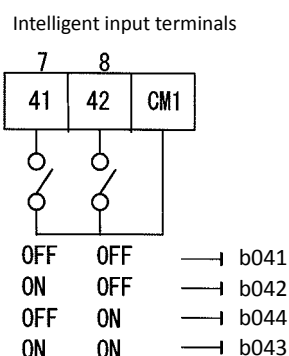

When applying the torque limitation function to the motor operation at low speeds, also use the overload restriction function.

4.2.101 Reverse Run protection function

The reverse Run protection function is effective when "03" (sensorless vector control), "04" (0Hz-range sensorless vector control), or "05" (vector control with sensor) is specified for the V/F characteristic curve selection (A044/A244).

For control reasons, especially during motor operation at low speed, the inverter may output a frequency that instructs the motor to rotate in the direction opposite to that specified by the operation command. If the counterrotation of the motor may damage the machine driven by the motor, enable the counterrotation prevention function.

Related code

A044/A244: V/F characteristic curve selection, 1st/2nd motors
b046: Reverse Run protection enable

Item	Function code	Data	Description
V/F characteristic curve selection	A044/A244	03	Sensorless vector control
		04	0Hz-range sensorless vector control
		05	Vector control with sensor (not available for A244)
Reverse Run protection enable	b046	00	Disabling counterrotation prevention
		01	Enabling counterrotation prevention

4.2.102 Torque LAD stop function

The torque LAD stop function is effective when "03" (sensorless vector control), "04" (0Hz-range sensorless vector control), or "05" (vector control with sensor) is specified for the V/F characteristic curve selection (A044/A244). This function temporarily stops the frequency-based deceleration function (LAD) when the torque limitation function operates.

Related code

A044/A244: V/F characteristic curve selection, 1st/2nd motors
 b040: Torque limit selection
 b041 to b044: Torque limits (1) to (4)
 b045: Torque limit LADSTOP enable

Item	Function code	Data or range of data	Description
V/F characteristic curve selection	A044/A244	03	Sensorless vector control
		04	0Hz-range sensorless vector control
		05	Vector control with sensor (not available for A244)
Torque limit selection	b040	00	Quadrant-specific setting mode
		01	Terminal-switching mode
		02	Analog input mode
		03	Option 1 mode
Torque limit (1)	b041	04	Option 2 mode
		CT mode: 0 to 200 (%) <0 to 180(>)>	Forward powering (in quadrant-specific setting mode)
Torque limit (2)	b042	VT mode: 0 to 150 (%) <0 to 150(>)>	Reverse regeneration (in quadrant-specific setting mode)
Torque limit (3)	b043		Reverse powering (in quadrant-specific setting mode)
Torque limit (4)	b044		Forward regeneration (in quadrant-specific setting mode)
Torque limit LADSTOP enable	b045	00	Disabling the torque LAD stop function
		01	Enabling the torque LAD stop function
Terminal function	C001 to C008	40	Whether to enable torque limitation
		41	Torque limit switch 1
		42	Torque limit switch 2

4.2.103 High-torque multi-motor operation

The high-torque multi-motor operation function allows you to make a single inverter operate the two motors (having the same specifications) that drive a single load (machine). This function is effective when the V/F characteristic curve selection is the sensorless vector control or 0Hz-range sensorless control. To use the function, adjust the inverter settings required for the sensorless vector control (see Section 4.2.92) or 0Hz-range sensorless control (see Section 4.2.93), except for the motor constant settings. Adjust the motor constants as follows:

- 1) For constants R1, R2, and L, specify a value half as large as that normally specified for one motor.
- 2) For constant I_o, specify a value twice as large as that normally specified for one motor.
- 3) For constant J, specify a value half as large as the total moment of inertia of the two motors and the load connected to them.

Select the motor capacity that is closest to the collective capacity of both motors.

If different loads are driven by the two motors operated by the inverter, the load fluctuations on one motor may change the other motor's operation status, and the inverter may be unable to normally control the motors. Be sure to configure your system so that the motors drive only a single load or multiple loads that can, at least, be recognized as a single load.

Related code

A044/A244: V/F characteristic curve selection, 1st/2nd motors
 F001: Output frequency setting
 b040: Torque limit selection
 b041 to b044: Torque limits (1) to (4)
 H002/H202: Motor data selection, 1st/2nd motors
 H003/H203: Motor capacity, 1st/2nd motors
 H004/H204: Motor poles setting, 1st/2nd motors
 H005/H205: Motor speed constant, 1st/2nd motors
 H020/H220: Motor constant R1, 1st/2nd motors
 H021/H221: Motor constant R2, 1st/2nd motors
 H022/H222: Motor constant L, 1st/2nd motors
 H023/H223: Motor constant I_o, 1st/2nd motors
 H024/H224: Motor constant J, 1st/2nd motors
 H050/H250: PI proportional gain, 1st/2nd motors
 H051/H251: PI integral gain, 1st/2nd motors
 H052/H252: P proportional gain setting, 1st/2nd motors

4.2.104 Easy sequence function

- You can create a user program with EzSQ (the programming software dedicated to the SJ700) on a personal computer, and download the program to your SJ700 series inverter. Thus, you can convert your inverter to a special machine on which user-defined functions are installed. Please refer to programming instruction of EzSQ user manual.
- The easy sequence function does not provide an operation mode exclusive for program-based operation. Therefore, you can arbitrarily select the devices to input frequency and operation commands to the inverter.
- In case of starting easy sequence program, you should set easy sequence function selection A017. You can select how to start program that the program always run or the program run only to activate the PRG terminal.
- The intelligent input/output terminals of the inverter include general-purpose input/output terminals dedicated to the easy sequence function. Those terminals can be used to freely write and read data to and from the inverter with instructions in the program.
- You can assign the parameters (e.g., frequency setting and acceleration/deceleration time parameters) that require adjustments on the actual inverter to user parameters (P130 to P131). If you do so, you can readjust the parameter data by using the digital operator without having to connect your personal computer to the inverter.
- If you specify a program number in each program you created, you will be able to check the program number on the monitor of the digital operator.
- Each user program is compiled, and stored as an intermediate code in the internal EEPROM of the inverter. (Data can be stored in EEPROM.)
- Even if the user data is initialized via the digital operator, downloaded programs and user parameters (P100 to P131) are not cleared.
- You cannot copy the downloaded program by an operation from a remote operator. You cannot copy the user parameter codes "P***", either. If necessary, download the user parameter codes from your personal computer.

Related code

A017: Easy sequence function selection
P100 to P131: Easy sequence user parameters

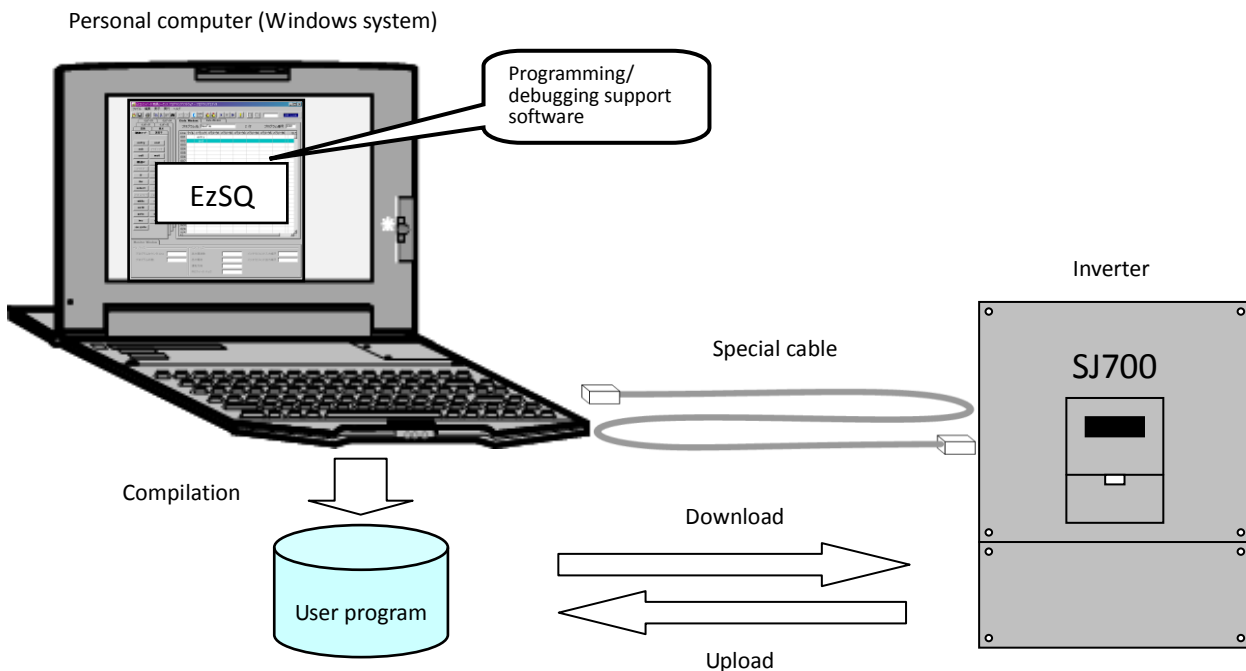

Inverter

SJ700

Special cable

Download

Upload

4.2.105 Data read/write selection

- When you use the operator 'WOP' to read and write inverter's settings and an EzSQ program, this function prevents incorrect reading and writing.
- Please refer to the WOP manual for more information of reading and writing function with WOP.

Related code

b166: data read/write selection

4.3 Functions Available When the Feedback Option Board (SJ-FB) Is Mounted

4.3.1 Functions requiring the SJ-FB

- The feedback option board (SJ-FB) is generally required in the following cases:
 <1> When "05" (V2: vector control with sensor) is specified for V/F characteristic curve selection, 1st motor(A044)
 <2> When pulse train frequency input is specified by one of the following methods:

- "06" (pulse train input) is specified for the run command source setting (A001).
- "10" (operation function result) is specified for the run command source setting (A001), and "05" (pulse train frequency) is specified for operation-target frequency selection 1 (A141) or operation-target frequency selection 2 (A142).
- "03" (pulse train frequency input) is specified for the PV source setting (A076).
- For the wiring and DIP switch setting of the SJ-FB, refer to the instruction manual for the SJ-FB.
- You can check the direction of motor rotation with the actual-frequency monitoring function (d008). For checking with this monitoring function, specify "00" (VC) for the V/F characteristic curve selection (A044) and make the inverter operate the motor. (Normally, a positive frequency is monitored when a forward-operation command is input, and vice versa.)

Related code

A044: V/F characteristic curve selection, 1st motor
 A001: Run command source setting
 A076: PV source setting
 A141: Operation-target frequency selection 1
 A142: Operation-target frequency selection 2

4.3.2 V2 control pulse setting

To use the V2 control pulse setting function, specify "00" (ASR: speed control mode) or "01" (APR: pulse train position control mode) for the control pulse setting (P012). In speed control mode, select a device to input frequency commands by the frequency source setting (A001).

In pulse train position control mode, each frequency command is generated from a position command pulse train and the feedback

of the position data detected by the encoder. The position command is input via an intelligent input terminal, to which the input of the pulse train position command is assigned. You can perform the position control with the command.

Select one of three input formats for the pulse train position command by the pulse train mode setting (P013).

To use the pulse train position control mode, assign function "48" (STAT) to an intelligent input terminal. The inverter accepts a pulse train position command only when the STAT terminal is on.

You can clear the position deviation data by an external signal. Assign function "47" (PCLR) to an intelligent input terminal. Turning the PCLR on and off clears the position deviation data in the inverter.

To output a speed deviation error signal, assign function "22" (DSE) to an intelligent input terminal, and specify a deviation level as the speed deviation error detection level (P027). If the deviation of the actual frequency (motor speed) from that specified by the frequency command exceeds the error detection level (P027), the inverter will output the DSE signal.

Related code

P012: Control pulse setting
 A001: Frequency source setting
 P013: Pulse train mode setting
 P011: Encoder pulse-per-revolution (PPR) setting
 P023: Position loop gain setting
 H004: Motor poles setting, 1st motor
 C001 to C008: Terminal [1] to [8] functions

Item	Function code	Data or range of data	Description
Control pulse setting	P012	00	ASR: Speed control mode
		01	APR: Pulse train position control mode
		02	APR2: Absolute position control mode
		03	HAPR: High resolution absolute position control mode
Pulse train mode setting (*2)	P013	00	MD0: 90°-phase-shift pulse train
		01	MD1: Forward/reverse operation command with pulse train
		02	MD2: Forward-operation pulse train with reverse-operation pulse train
Encoder pulse-per-revolution (PPR) setting	P011	128. to 9999. or 1000 to 6553 (10000 to 65535) (pulses)	Pulse count of encoder
Position loop gain setting (*1)	P023	0.00 to 99.99 or 100.0 (rad/s)	Position loop gain
Speed deviation error detection level setting	P027	0.00 to 99.99 or 100.0 to 120.0 (Hz)	Deviation level at which to output the DSE signal
Motor poles setting, 1st motor	H004	2, 4, 6, 8, or 10 (poles)	Selection of the number of poles of the motor
Terminal function	C001 to C008	47	PCLR: Clearance of position deviation data
		48	STAT: Pulse train position command input enable
Terminal function	C021 to C025	22	DSE: Speed deviation error signal
Alarm relay terminal function	C026	22	DSE: Speed deviation error signal

4.3.3 Vector control with encoder feedback

- To use this control function, specify "05" (V2) for the V/F characteristic curve selection (A044). (You can specify the vector control with sensor only when the 1st motor control is selected.)
- Before using this function, be sure to make optimum constant settings for the motor with reference to Section 4.2.95, "Motor constant selection." Also, set the pulse count of the encoder to be used.
- You can select the speed control or pulse train position control mode by the pulse train mode setting (P013).
- When using this function, observe the following precautions:
 - 1) If you use the inverter to drive a motor of which the capacity is two classes lower than the maximum applicable capacity of the inverter, you may not be able to obtain adequate motor characteristics.
 - 2) If the inverter does not accelerate the motor normally or the overload protection operates, check the phase sequence of the encoder signal. (For forward rotation, phase B normally leads phase A by a phase angle of 90°.) You can check the direction of motor rotation with the actual-frequency monitoring function (d008). For checking with this monitoring function, specify "00" (VC) for the V/F characteristic curve selection (A044) and make the inverter operate the motor. (Normally, a positive frequency is monitored when a forward-operation command is input, and vice versa.)
 - 3) If you cannot obtain the desired characteristics from the motor driven under the vector control with sensor, readjust the motor constants according to the symptom, as described in the table below.

Related code

A001: Frequency source setting
 A044/A244: V/F characteristic curve selection, 1st/2nd motors
 F001: Output frequency setting
 b040: Torque limit selection
 b041 to b044: Torque limits (1) to (4)
 H002/H202: Motor data selection, 1st/2nd motors
 H003/H203: Motor capacity, 1st/2nd motors
 H004/H204: Motor poles setting, 1st/2nd motors
 H005/H205: Motor speed constant, 1st/2nd motors
 H020/H220: Motor constant R1, 1st/2nd motors
 H021/H221: Motor constant R2, 1st/2nd motors
 H022/H222: Motor constant L, 1st/2nd motors
 H023/H223: Motor constant I_o, 1st/2nd motors
 H024/H224: Motor constant J, 1st/2nd motors
 H050/H250: PI proportional gain, 1st/2nd motors
 H051/H251: PI integral gain, 1st/2nd motors
 H052/H252: P proportional gain setting, 1st/2nd motors
 P011: Encoder pulse-per-revolution (PPR) setting
 P012: Control pulse setting

Operation status	Symptom	Adjustment method	Adjustment item
Starting	The motor generates an impact when it starts.	Reduce the motor constant J from the set value.	H024/H034
Decelerating	The motor runs unsteadily.	Reduce the speed response setting.	H005
		Reduce the motor constant J from the set value.	H024/H034
Torque-limited operation	Torque is insufficient during the torque-limited operation at low frequencies.	Reduce the overload restriction level to lower than the torque limiter level.	b021, b041 to b044
Low-frequency operation	Motor rotation is inconsistent.	Increase the motor constant J from the set value.	H024/H034

Note 1: Always set the carrier frequency (b083) to 2.1 kHz or more. If the carrier frequency is less than 2.1 kHz, the inverter cannot operate the motor normally.

Note 2: When driving a motor of which the capacity is one class lower than the inverter, adjust the torque limit (b041 to b044) so that the value " α ", calculated by the expression below, does not exceed 200%. Otherwise, the motor may be burnt out.

$$\alpha = \text{"torque limit"} \times (\text{inverter capacity}) / (\text{motor capacity})$$

(Example) When the inverter capacity is 0.75 kW and the motor capacity is 0.4 kW, the torque limit value is calculated as follows, based on the assumption that the value " α " should be 200%:
 Torque limit (b041 to b044) = $\alpha \times (\text{motor capacity}) / (\text{inverter capacity}) = 200\% \times (0.4 \text{ kW}) / (0.75 \text{ kW}) = 106\%$

4.3.4 Torque biasing function

The torque biasing function allows you to make the inverter bias the torque command generated during the operation in speed control mode. You can effectively use this function for inverter applications to a lift or other elevating machines.

Related code

P036: Torque biasing mode selection
P037: Torque bias setting
P038: Torque biasing polarity selection
d010: Torque bias monitoring

Item	Function code	Data or range of data	Description
Torque biasing mode selection	P036	00	None
		01	Bias setting from the digital operator
		02	Bias setting via the O2 terminal (*1)
Torque bias setting	P037	-200 to +200 (%) <-180 to +180>(*3)	Valid when "P036" = "01"
Torque biasing polarity selection (*2)	P038	00	Depending on the sign of bias value
		01	Depending on the motor rotation direction

*1 When the torque bias is set as a signal input via the O2 terminal, the inverter recognizes the signal voltage -10 to +10 (V) as the bias value -200 to +200 (%).

- *2 1) When "00" (depending on the sign of the bias value) is specified:
Regardless of the direction of motor rotation, torque in the forward direction increases when the torque bias signal indicates a positive (+) value. Torque in the reverse direction increases when the torque bias signal indicates a negative (-) value.
- 2) When "01" (depending on the motor rotation direction) is specified:
The sign of the bias value indicated by the torque bias signal and the direction of the torque biasing change according to the rotation direction specified by the operation command.
With a forward operation command: the torque is generated in the same direction as that specified by the sign of the torque bias value.
With a reverse operation command: the torque is generated in the opposite direction to that specified by the sign of the torque bias value.

*3 <>:applied for 75 to 150kW

4.3.5 Torque control function

The torque control function is effective in the V2 control mode. You can use the inverter not only under the speed control or pulse train position control but also with this torque control function. You can use this function effectively for inverter applications to, for example, a winding machine.

To operate the inverter to drive the motor under torque control, assign function "52" (ATR) to an intelligent input terminal. The torque command input is enabled when the ATR terminal is on.

You can select one of four torque command input methods (digital operator and three analog input terminals) by the torque command input selection (P034).

Related code

P033: Torque command input selection
P034: Torque command setting
P035: Polarity selection at the torque command input via the O2 terminal
P039: Speed limit for torque-controlled operation (forward rotation)
P040: Speed limit for torque-controlled operation (reverse rotation)
d009/d010/d012: Torque command monitoring
P036: Torque biasing mode selection
P037: Torque bias setting
P038: Torque biasing polarity selection
d010: Torque bias monitoring
C001 to C008: Terminal [1] to [8] functions

Item	Function code	Data or range of data	Description
Torque command input selection	P033	00	Input from the O terminal
		01	Input from the OI terminal
		02	Input from the O2 terminal
		03	Input from the digital operator
Torque command setting	P034	0 to 200 (%) <0 to 180(>)>	Torque setting for the input from the digital operator (P033 = 03)
Polarity selection at the torque command input via the O2 terminal	P035	00	Depending on the sign of torque value
		01	Depending on the motor rotation direction
Speed limit for torque-controlled operation (forward rotation)	P039	0.00 to 99.99 or 100.0 to 400.0 (Hz)	
Speed limit for torque-controlled operation (reverse rotation)	P040	0.00 to 99.99 or 100.0 to 400.0 (Hz)	
Torque biasing mode selection	P036	00	None
		01	Bias setting from the digital operator
		02	Bias setting via the O2 terminal
Torque bias setting	P037	-200 to +200 <-180 to 180>(>)	Valid when "P036" = "01"
Torque biasing polarity selection	P038	00	Depending on the sign of bias value
		01	Depending on the motor rotation direction
Terminal function	C001 to C008	52	ATR: Permission for torque command input

*1 <>:applied for 75 to 150kW

<Control block diagram>

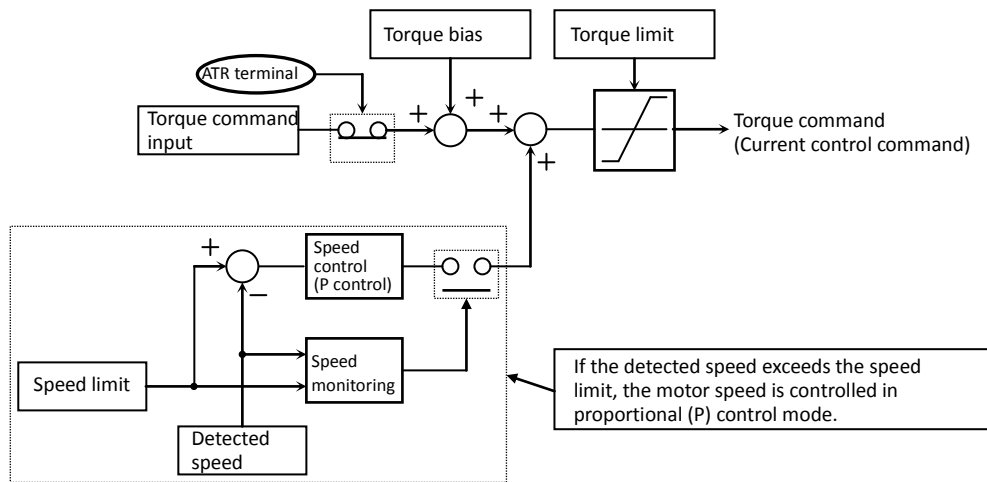

4.3.6 Pulse train position control mode

- To use this function, specify "05" (V2) for V/F characteristic curve selection, 1st motor (A044) and "01" (pulse train position control mode) for the control pulse setting (P012).
- You can choose the input source of pulse train command pulse train mode setting (P013).

Item	Function code	Data or range of data	Description
Control pulse setting	P012	01	Pulse train position control mode
Pulse train mode setting (*2)	P013	00	MD0: 90°-phase-shift pulse train
		01	MD1: Forward/reverse operation command with pulse train
		02	MD2: Forward-operation pulse train with reverse-operation pulse train
Home search completion range setting	P017	0. to 9999. / 1000 (100000)	Equivalent to encoder quadruplex
Home search completion delay time setting	P018	0.00 to 9.99 (s)	
Electronic gear set position selection	P019	00	FB : Feed back side
		01	REF : Controller side
Electronic gear ratio numerator setting	P020	1. to 9999.	
Electronic gear ratio denominator setting	P021	1. – 9999.	
Feed-forward gain setting	P022	0.00 to 99.99 / 100.0 to 655.3	
Position loop gain setting	P023	0.00 to 99.99 / 100.0 (rad/s)	
Position bias setting	P024	-204 (-2048) / -999. to 2048.	
Terminal function	C001 to C008	47	PCLR: Clearance of position deviation data
		48	STAT: Pulse train position command input enable

*1 In pulse train position control mode, the frequency value of a frequency command is calculated as follows:

$$\text{Frequency command (Hz)} = \frac{6.4 \times P \times K_v}{\text{ENC}} \times \frac{\Delta P}{255}$$

P: Number of poles of the motor
 Kv: Position loop gain
 ENC: Encoder pulse count
 ΔP: Position deviation

In position control mode, the setting for the acceleration and deceleration time is invalid. (The LAD cancellation function operates automatically to ignore acceleration and deceleration patterns.) When the position loop gain is larger, the acceleration/deceleration time is shorter.

*2 The following timing charts show the detailed operations in pulse train input mode.

1) MD0: 90°-phase-shift pulse train

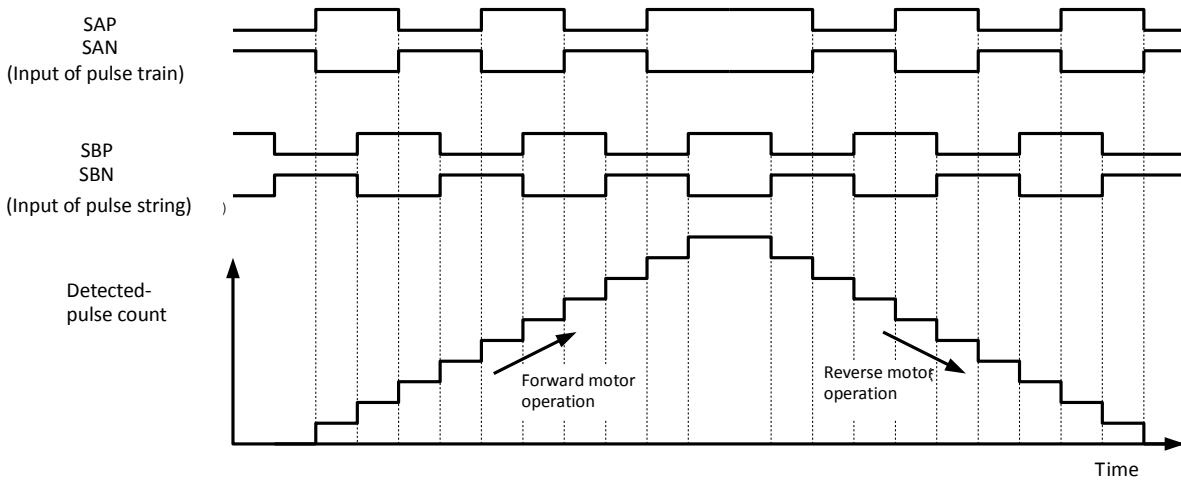

2) MD1: Forward/reverse operation command with pulse train

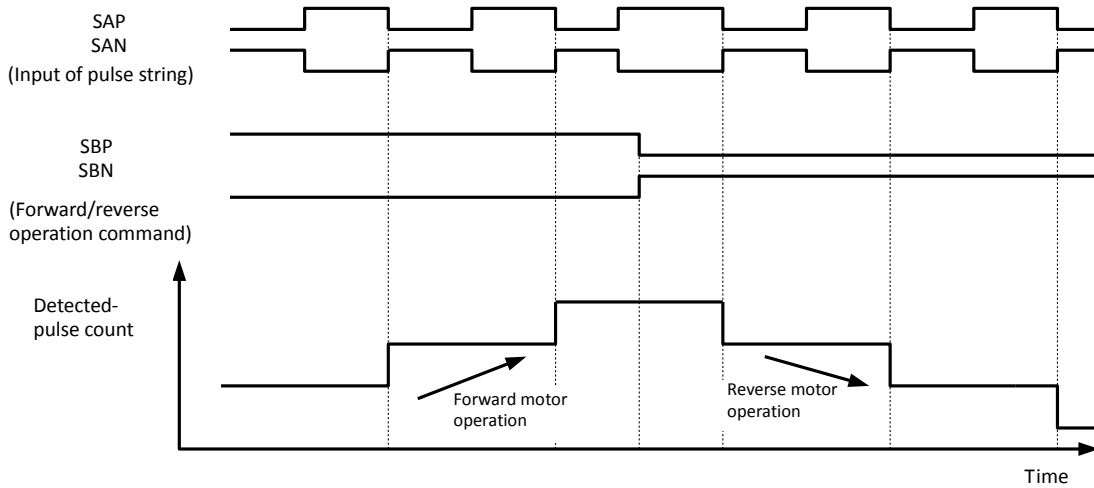

3) MD2: Forward-operation pulse train with reverse-operation pulse train

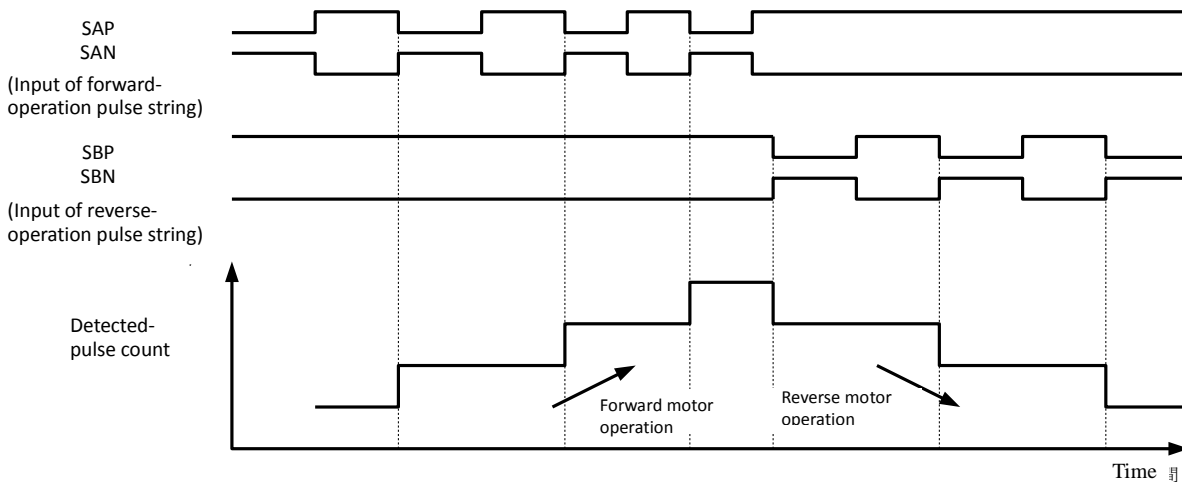

4.3.7 Electronic gear function

The electronic gear function allows you to set a gain on the position command or position feedback data to adjust the ratio between the main motor and sub-motor speeds during the synchronous operation of the motors.

Related code

P019: Electronic gear set position selection
 P020: Electronic gear ratio numerator setting
 P021: Electronic gear ratio denominator setting
 P022: Feed-forward gain setting
 P023: Position loop gain setting

Item	Function code	Data or range of data	Description
Electronic gear set position selection	P019	00	Position feedback (FB) side
		01	Position command (REF) side
Electronic gear ratio numerator setting (Note 4)	P020	1 to 9999	
Electronic gear ratio denominator setting (Note 4)	P021	1 to 9999	
Feed-forward gain setting (Note 2)	P022	0.00 to 655.3	
Position loop gain setting (Note 3)	P023	0.00 to 99.99 or 100.0 (rad/s)	

Note 1: Block diagrams for the electronic gear function are shown below.

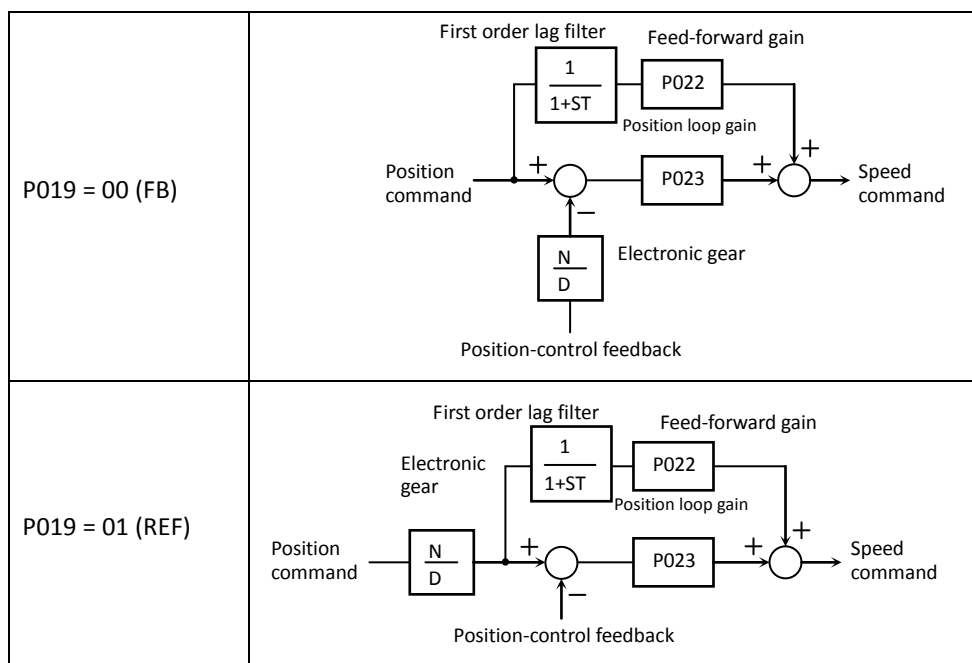

Note 2: You are recommended to set the feed-forward gain setting (P022) to 2.00 first when adjusting the feed-forward gain. To reduce the position deviation between the main motor and sub-motor, increase the feed-forward gain. If the motor operation is unstable, reduce the feed-forward gain.

Note 3: You are recommended to set the position loop gain (P023) to 2.00 first when adjusting the loop gain. To increase the positioning accuracy and position-holding force, increase the loop gain. If a high loop gain results in unstable motor operation, reduce the loop gain.

Note 4: The electronic gear ratio (N/D) must be within the following range:
 $1/50 \leq N/D \leq 20$

N: Electronic gear ratio numerator (P020)

D: Electronic gear ratio denominator (P021)

<Example of use: Synchronous operation>

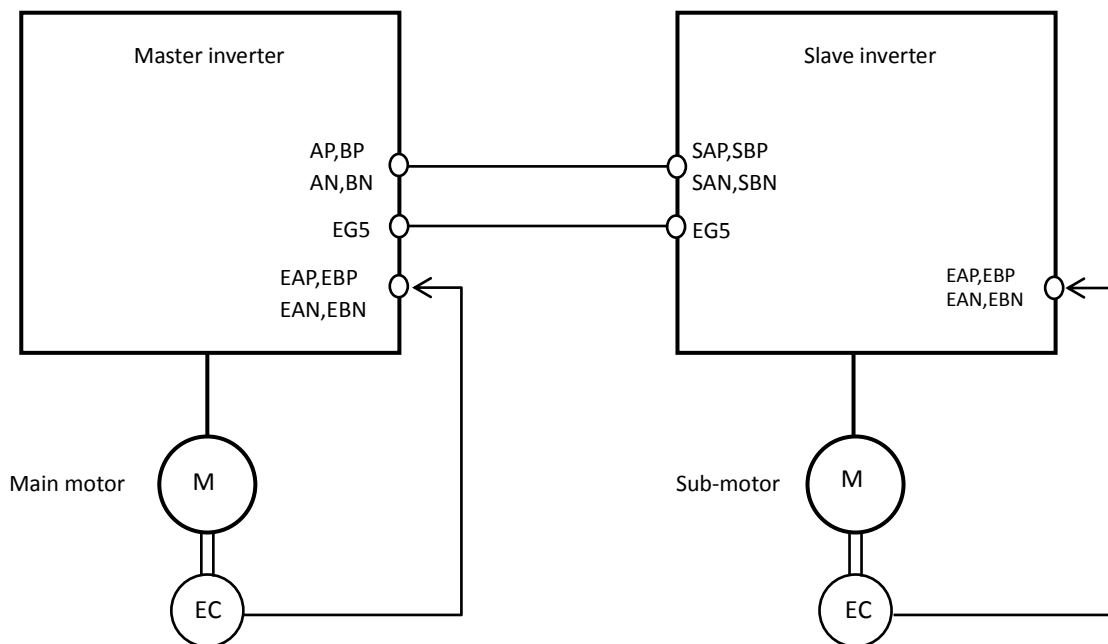

On the inverter (master inverter) for the main motor, specify either the speed control (ASR:P012=00) or pulse train position control mode (APR:P012=01).

On the inverter (slave inverter) for the sub-motor, specify the pulse train position control mode (APR:P012=01). And set the frequency source setting(A001) selection to the pulse row input"06". Please set the pulse train position command input enable signal(STAT) to an unused input terminal. Afterwards, put the intelligent input terminal into the state of turning on.

<Example of settings>

- Main motor: Encoder pulse-per-revolution (PPR) setting = 1024 (pulses)
- Sub-motor: Encoder pulse-per-revolution (PPR) setting = 3000 (pulses)
- Ratio of main motor speed to sub-motor speed: 2:1

To operate the motors under the above conditions, adjust the parameters on the slave inverter as follows:

- Pulse train mode setting (P013): 00 (90°-phase-shift pulse train)
- Electronic gear set position selection (P019): 01 (REF)
- Electronic gear ratio numerator setting (P020): 3000
- Electronic gear ratio denominator setting (P021): 1024 x 2 = 2048

The table below lists the examples of the ratio of main motor speed to sub-motor speed according to the settings of "P019" to "P021" (on the assumption that the encoder pulse-per-revolution (PPR) setting of "1024" should be set on both inverters).

Electronic gear set position selection (P019)	REF (Position command side)	REF (Position command side)	FB (Position feedback side)	FB (Position feedback side)
Electronic gear ratio numerator setting (P020)	1024	2048	1024	2048
Electronic gear ratio denominator setting (P021)	2048	1024	2048	1024
Sub-motor speed/main motor speed	1/2	2	2	1/2

-Please confirm the instruction value in which the rotational speed corresponds between while the mastering inverter is driven is displayed in the output frequency setting(F001) on the slave side when the driving instruction is put, and the slave side doesn't drive.

-Please raise and adjust the feed-forward gain setting(P022) or the positional loop gain setting(P023) when the response of the follow on the slave side is late. (Refer to Chapter 4.3.7)

4.3.8 Motor gear ratio setting function

The motor gear ratio setting function allows you to make the inverter effectively control a specific machine in which an encoder is installed at the opposite end of the motor.

Specify the actual pulse count of the encoder as the encoder pulse-per-revolution (PPR) setting (P011). Specify the ratio of the motor speed to the encoder speed as the motor gear ratio (numerator "P028" and denominator "P029").

According to the above settings, the encoder pulse-per-revolution (PPR) setting data converted into motor shaft data is set in the inverter.

The encoder pulse-per-revolution (PPR) setting data converted into motor shaft data is used to detect speeds and positions. The data specified as the encoder pulse-per-revolution (PPR) setting (P011) is used to calculate the home search stop position.

Item	Function code	Range of data	Description
Numerator of the motor gear ratio	P028	1. to 9999	Setting of the ratio of motor speed to encoder speed
Denominator of the motor gear ratio	P029	1. to 9999	
Encoder pulse-per-revolution (PPR) setting	P011	128. to 9999., 1000 to 6553 (10000 to 65530) (pulses)	Setting of the actual pulse count of encoder

Note 1: The motor gear ratio (N/D) must be within the following range:

$$1/50 \leq N/D \leq 20$$

N: Numerator of the motor gear ratio

D: Denominator of the motor gear ratio

<Example of use>

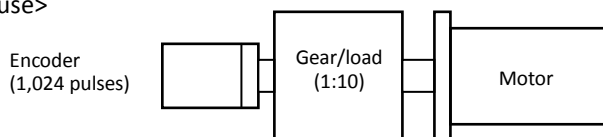

If the ratio of the motor speed to the encoder speed is 1:10, set the following data:

Encoder pulse-per-revolution (PPR) setting (P011): 1024

Numerator of the motor gear ratio (P028): 10

Denominator of the motor gear ratio (P029): 100

In this case, the periphery of the encoder shaft is divided into 4,096 sections to determine the points for home search.

Note that the conceptual layout of the home search stop position is inverted from that shown in Figure 7-2.

4.3.9 Position biasing function

- The position biasing function allows you to make the position command bias during operation in pulse train position control mode.

This function adds the specified number of pulses to the variation of position data every 2 ms. Use this function to adjust the phase of the synchronization point during synchronous operation.

- Specify the quantity to be added as the position bias quantity (P024).

Related code
P024: Position bias quantity

4.3.10 Speed biasing function

- This function allows you to make the speed command bias during operation in pulse train position control mode.

- Specify the bias quantity for the additional-frequency setting (A145), and select a sign through additional-frequency sign selection (A146).

- Assign function "50" (ADD) to an intelligent input terminal. The speed command is biased by the specified quantity while the ADD terminal is on.

Related code
A145: Additional-frequency setting
A146: Additional-frequency sign selection

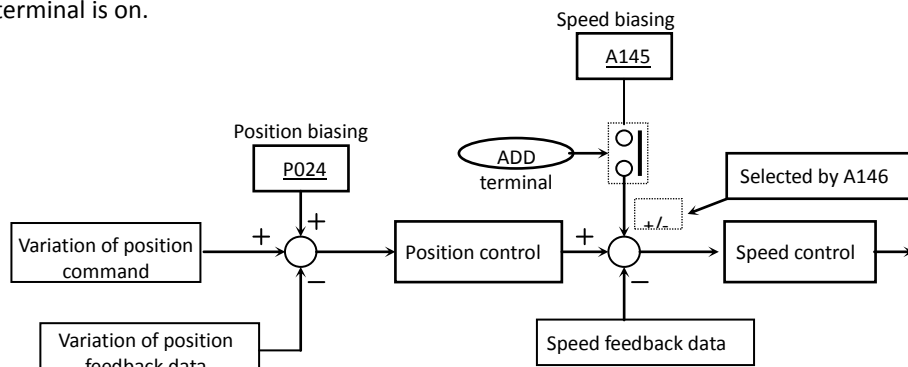

4.3.11 Home search function

The home search function allows you to make the inverter locate the motor shaft at a specified position. You can use this function, for example, to stop a metal-cutting machine to replace the tool attached to the main spindle. When using the home search function, be sure to insert a reference point pulse signal between the EZP pulse and EZN pulse signals from the encoder.

Related code

P011: Encoder pulse-per-revolution (PPR) setting
 P014: Home search stop position setting
 P015: Home search speed setting
 P016: Home search direction setting
 P017: Home search completion range setting
 P018: Home search completion delay time setting
 P023: Position loop gain setting
 C001 to C008: Terminal [1] to [8] functions
 C021 to C025: Terminal [11] to [15] functions
 C026: Alarm relay terminal function

Item	Function code	Data or range of data	Description
Encoder pulse-per-revolution (PPR) setting	P011	128. to 9999. or 1000 to 6553 (10000 to 65535) (pulses)	
Home search stop position setting	P014	0. to 4095.	
Home search speed setting	P015	0.00 to 99.99 or 100.0 to 120.0 (Hz)	See Note 1.
Home search direction setting	P016	00	
		01	
Home search completion range setting	P017	0. to 9999. or 1000 (10000) (pulses)	
Home search completion delay time setting	P018	0.00 to 9.99 (s)	
Position loop gain setting	P023	0.00 to 99.99 or 100.0 (rad/s)	
Terminal function	C001 to C008	45	
Terminal function	C021 to C025	23	ORT: Orientation
Alarm relay terminal function	C026		POK: Positioning end signal

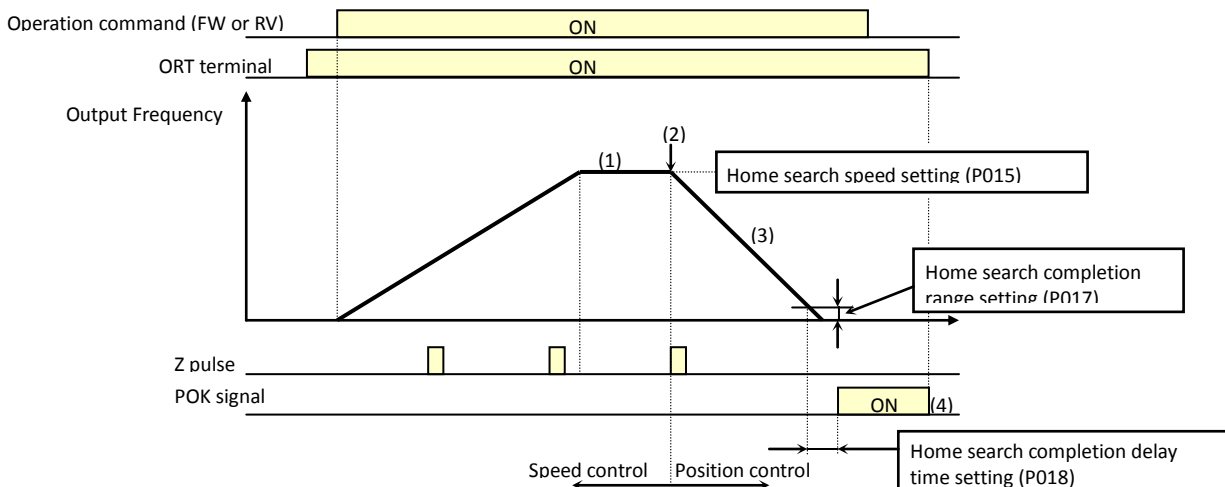

- 1) When the operation command is turned on with the ORT terminal turned on, the inverter accelerates the motor to the speed specified by the home search speed setting (P015), and then runs the motor at a constant speed. (If the motor is already running, the inverter changes the speed to the home search speed when the ORT terminal is turned on.)
- 2) After the home search speed is reached, the inverter switches to position control mode when it detects the first Z pulse.
- 3) The inverter performs position control by rotating the motor by one turn as the target amount from the position specified by the home search stop position setting (P014) when running the motor forward, or by two turns as the target amount from the home search stop position (P014) when running the motor reversely. In this case, the shorter the deceleration time, the larger the position loop gain setting (P023) becomes. (This deceleration time does not follow the deceleration time setting.)
- 4) The inverter outputs a POK signal when the time specified by the home search completion delay time setting (P018) elapses after the remaining number of pulses enters the range specified by the home search completion range setting (P017). (The inverter continues to output the POK signal until the ORT terminal is turned off.) After home search operation has been completed, servo lock status continues until the operation command is turned off.

- Note 1: Since the inverter positions the motor shaft within two turns while decelerating the motor, do not specify a high frequency as the home search speed. Otherwise, the inverter may trip during home search because of the overvoltage protection function.
- Note 2: For setting the home search stop position, the periphery of the motor shaft is divided into 4,096 sections to determine points No. 0 to No. 4095, beginning at the reference point in the direction of forward rotation. (The division into 4,095 sections is irrelevant to the encoder pulse-per-revolution (PPR) setting.) The reference point is specified as the point at which the Z pulse inserted between the EZP pulse and EZN pulse signals is detected. Figure 7-2 shows the layout of the reference point and target stop positions on the periphery of the motor shaft viewed from the load side of the motor shaft (in case of positive-phase connection).

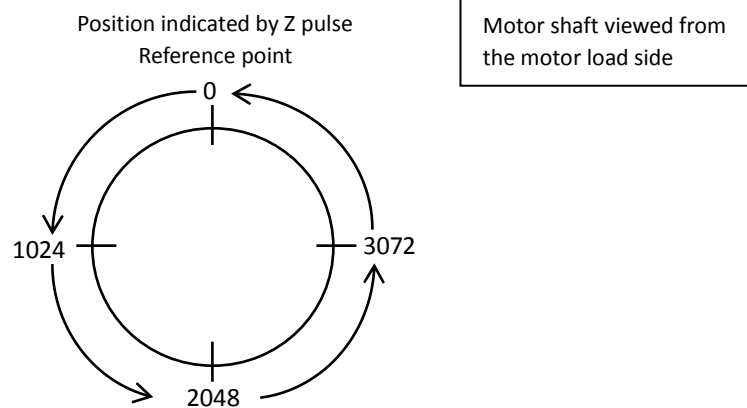

4.3.12 Absolute position control mode

- To use the absolute position control mode function, specify "05" (V2) for V/F characteristic curve selection, 1st motor (A044) and "02" (APR: absolute position control) for the control pulse setting (P012).
- If "03" (high-resolution absolute position control) has been specified for the control pulse setting (P012), the quadruple number of pulses used for internal operations is applied to the control. (Then, specify values of quadruple precision for the multistage position settings and position range specification.)
- Position settings can be switched in up to eight stages in combination with control pulse settings.
- You can select zero-return mode from one low-speed and two high-speed modes. (The home search function described in the preceding section cannot be used.)
- The teaching function allows you to specify position settings while actually running the machine.
- If function "73" (SPD) is assigned to an intelligent input terminal, you can switch between the speed control and position control modes during operation.
- Only the four high-order digits of data are displayed when the data (e.g., position setting) to be displayed consists of a large number of many digits.

Related code

P012: Control pulse setting
 P023: Position loop gain setting
 P060: Multistage position setting 0
 P061: Multistage position setting 1
 P062: Multistage position setting 2
 P063: Multistage position setting 3
 P064: Multistage position setting 4
 P065: Multistage position setting 5
 P066: Multistage position setting 6
 P067: Multistage position setting 7
 P068: Zero-return mode selection
 P069: Zero-return direction selection
 P070: Low-speed zero-return frequency
 P071: High-speed zero-return frequency
 P072: Position range specification (forward)
 P073: Position range specification (reverse)
 P074: Teaching selection
 C169: Multistage speed/position determination time
 C001 to C008: Terminal [1] to terminal [8]

Item	Function code	Data/range of data	Description
Control pulse setting	P012		APR2: Absolute position control
Position loop gain setting	P023		HAPR: High-resolution absolute position control
Multistage position setting 0	P060	Position range specification (reverse) to position range specification (forward)	
Multistage position setting 0	P061	Position range specification (reverse) to position range specification (forward)	
Multistage position setting 0	P062	Position range specification (reverse) to position range specification (forward)	
Multistage position setting 0	P063	Position range specification (reverse) to position range specification (forward)	
Multistage position setting 0	P064	Position range specification (reverse) to position range specification (forward)	
Multistage position setting 0	P065	Position range specification (reverse) to position range specification (forward)	
Multistage position setting 0	P066	Position range specification (reverse) to position range specification (forward)	
Multistage position setting 0	P067	Position range specification (reverse) to position range specification (forward)	
Zero-return mode selection	P068	00	
		01	
		02	
Zero-return direction selection	P069	00	For forward rotation
		01	For reverse rotation
Low-speed zero-return frequency	P070	0.00 to 10.00 (Hz)	
High-speed zero-return frequency	P071	0.00 to 99.99 / 100.0 to 400.0 (Hz)	
Position range specification (forward)	P072	0 to +268435456	When APR2 is selected
		0 to +1073741823	When HAPR is selected
Position range specification (reverse)	P073	0 to +268435456	
		0 to +1073741823	
Teaching selection	P074	00	Multistage position setting 0 (P060)
		01	Multistage position setting 0 (P060)
		02	Multistage position setting 0 (P060)
		03	Multistage position setting 0 (P060)
		04	Multistage position setting 0 (P060)
		05	Multistage position setting 0 (P060)
		06	Multistage position setting 0 (P060)
		07	Multistage position setting 0 (P060)
Multistage speed/position determination time	C169	0. to 200.	X10ms

Position setting monitor	d029	-1073741823 to + 1073741823	
Position feedback monitor	d030	-1073741823 to + 1073741823	
	C001-C008	54	SON: Servo-on
		66	CP1: Position setting selection 1
		67	CP2: Position setting selection 1
		68	CP3: Position setting selection 1
		69	ORL: Zero-return limit signal
		70	ORG: Zero-return start signal
		71	FOT: Forward drive stop
		72	ROT: Reverse drive stop
		73	SPD: Switching between speed and position controls
		45	ORT: Teaching
Reset mode selection	C102	03	Internal data is not initialized by a reset.

4.3.13 Operation in absolute position control mode

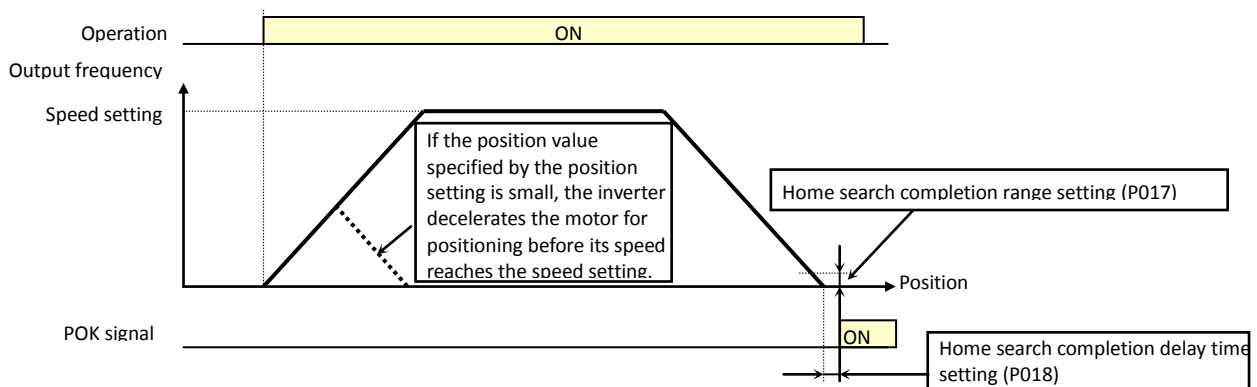

- In absolute position control mode, the inverter runs the motor until the machine reaches the target position according to the following settings, and then sets the machine into the position servo-lock state:

- <1> Position setting
- <2> Speed setting (frequency setting)
- <3> Acceleration and deceleration time

(The servo-lock state is held until the operation command is turned off.)

- In absolute position control mode, the frequency and acceleration/deceleration settings selected at absolute position control are applied.

- If the position value specified by the position setting is small, the inverter may decelerate the motor for positioning before its speed reaches the speed setting.

- In absolute position control mode, the rotating-direction setting (FW or RV) of the operation command is ignored.

The operation command simply functions as the signal to run or stop the motor. The motor runs in the forward direction when the value of "target position - current position" is positive, or in the reverse direction when the value is negative.

- If zero-return operation (described below) is not performed, the motor position detected at power-on is assumed as the origin (position data = 0).

- When the operation command is turned on with 0 specified as the position setting, positioning is completed without running the motor.

- Specify "03" (to only reset a trip) for reset mode selection (C102).

* If a value other than "03" is specified for reset mode selection (C102), the current position counter is cleared when the inverter reset terminal (reset key) is turned on. Be sure to specify "03" for reset mode selection (C102) if you intend to use the value of the current position counter for operation after recovering the inverter from tripping by turning on the reset terminal (reset key).

- If the PCLR function is assigned to a terminal, turning on the PCLR terminal clears the current position counter. (Note that the internal position deviation counter is also cleared at the same time.)

- In absolute position control mode, the ATR terminal is ineffective. (Torque control is disabled.)

- In absolute position control mode, the STAT terminal is ineffective. (Pulse train position control is disabled.)

- In absolute position control, the home search function is disabled.

(Note that the ORT terminal is used for the teaching function described below.)

4.3.14 Multistage position switching function (CP1/CP2/CP3)

- When functions "66" (CP1) to "68" (CP3) are assigned to terminal [1] function (C001) to terminal [8] function (C008), you can select a position setting from multistage positions 0 to 7.
- Use multistage position settings 0 to 7 (P060 to P067) for the position settings.
- If no position settings are assigned to terminals, multistage position setting 0 (P060) is assumed.

Position setting	CP3	CP2	CP1
Multistage position setting 0	0	0	0
Multistage position setting 1	0	0	1
Multistage position setting 2	0	1	0
Multistage position setting 3	0	1	1
Multistage position setting 4	1	0	0
Multistage position setting 5	1	0	1
Multistage position setting 6	1	1	0

- You can specify a delay to be applied at multistage position setting input, until the relevant terminal input is determined. Use this specification to prevent the application of fluctuating terminal input before it is determined.
- You can adjust the determination time with the multistage speed/position determination time setting (C169). The input data is finally determined when the terminal input becomes stable after the delay set as C169. (Note that a long determination time deteriorates the input terminal response.)

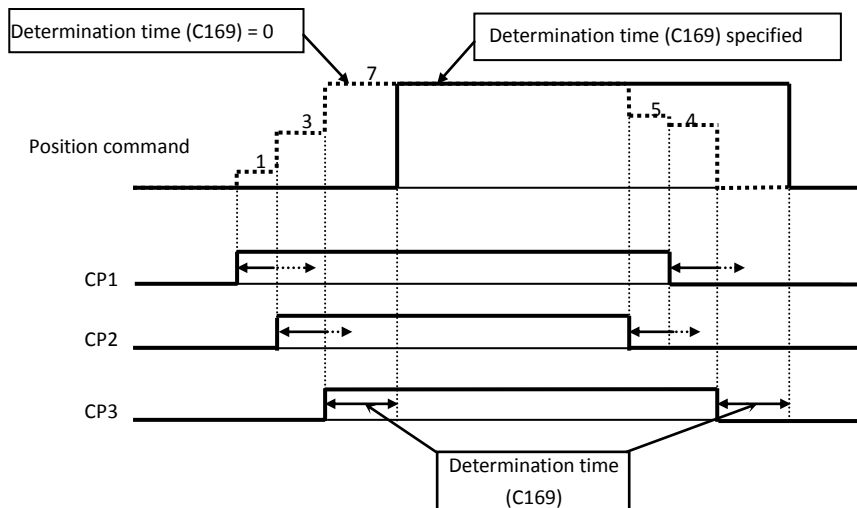

4.3.15 Speed/position switching function (SPD)

- To perform speed control operation in absolute position control mode, turn on the SPD terminal.
- While the SPD terminal is off, the current position count remains at 0. Therefore, if the SPD terminal is turned off during operation, the control operation is switched to position control operation based on the position where the terminal is turned off. (Speed control operation is switched to position control operation.)
- If the position setting is 0 at this time, the inverter stops the motor at that position. (Hunting may occur if a certain position loop gain value has been set.)
- While the SPD terminal is on, the rotating direction depends on the operation command. When switching from speed control to position control, pay attention to the sign of the value set in the operation command.

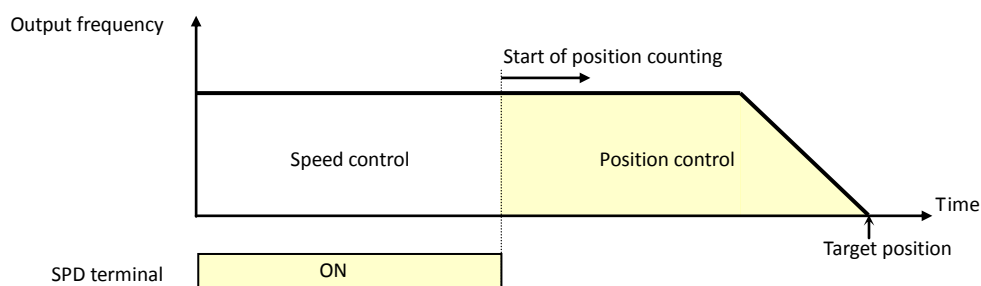

4.3.16 Zero-return function (ORG, ORL)

- One of three types of zero-return operations can be selected by zero-return mode selection (P068). When a zero-return operation ends, the current position counter is cleared (to 0).
- Use zero-return direction selection (P069) to select the direction of zero-return operation.
- If zero-return operation is not performed, position control is performed based on the assumption that the motor position detected at power-on is the origin.

<1> Low-speed zero-return

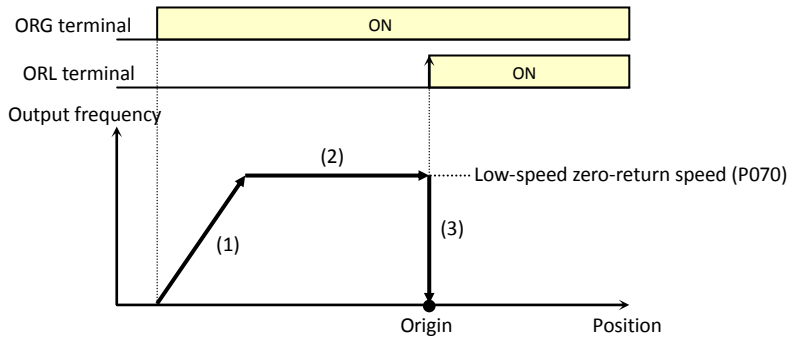

- (1) The inverter accelerates the motor for the specified acceleration time to the low-speed zero-return speed.
- (2) The inverter runs the motor at the low-speed zero-return speed.
- (3) The inverter performs positioning when the ORL signal is input.

<2> High-speed zero-return

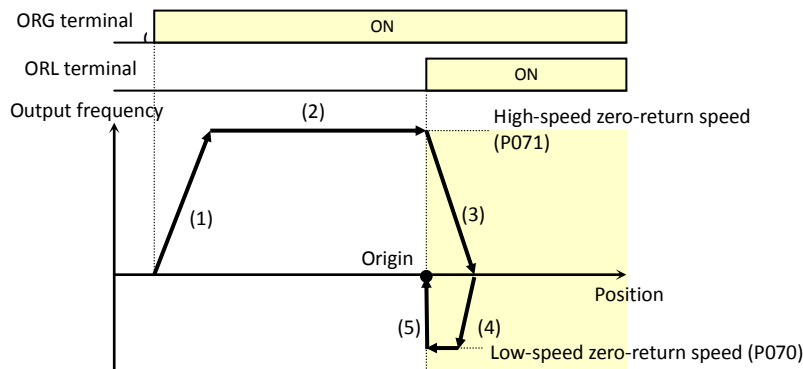

- <1> The inverter accelerates the motor for the specified acceleration time to the high-speed zero-return speed.
- <2> The inverter runs the motor at the high-speed zero-return speed.
- <3> The inverter starts deceleration when the ORL signal is turned on.
- <4> The inverter runs the motor in the reverse direction at the low-speed zero-return speed.
- <5> The inverter performs positioning when the ORL signal is turned off.

<3> High-speed zero-return 2

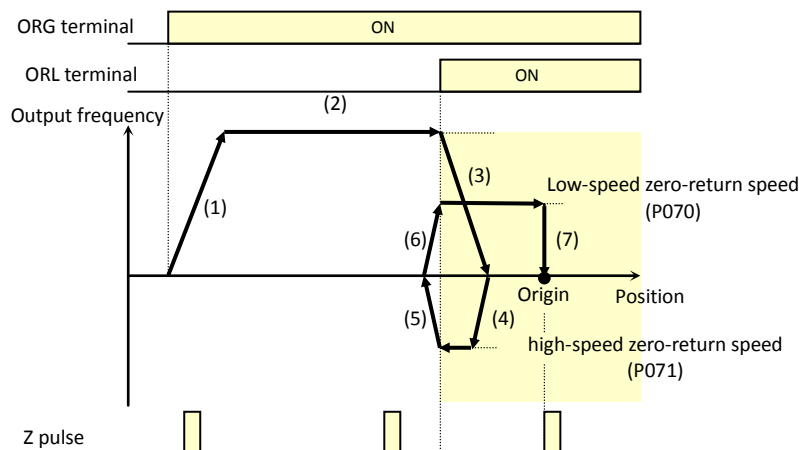

- <1> The inverter accelerates the motor for the specified acceleration time to the high-speed zero-return speed.
- <2> The inverter runs the motor at the high-speed zero-return speed.
- <3> The inverter starts deceleration when the ORL signal is turned on.
- <4> The inverter runs the motor in the reverse direction at the low-speed zero-return speed.
- <5> The inverter starts deceleration when the ORL signal is turned off.
- <6> The inverter runs the motor in the forward direction at the low-speed zero-return speed.
- <7> The inverter performs positioning at the first Z pulse position after the ORL signal is

turned on.

4.3.17 Forward/reverse drive stop function (FOT/ROT)

Related code
C001-C008 intelligent input terminals

- The forward/reverse drive stop function allows you to prevent motor operation from deviating from the specified control range according to signals from the control range limit switches.
- When the FOT terminal is turned on, the torque for forward rotation is limited to 10%. When the ROT terminal is turned on, the torque for reverse rotation is limited to 10%. This function can be used as a limit switch function at the machine end. This function is activated by setting 71 (FOT) and 72 (ROT) on intelligent input terminals 1-8 (C001- C008)

4.3.18 Position range specification function

Related code
P072: Position range specification (forward)
P073: Position range specification (reverse)

- The position control ranges for forward and reverse rotations can be specified by the position range specification (forward) (P072) and position range specification (reverse) (P073), respectively. If the value of the current position counter exceeds one of these ranges, a position control range error (E63.* or E73.*) causes the inverter to trip and enter free-running status.
 - The values specified by P072 and P073 limit the maximum values of multistage position settings 0 to 7 (P060 to P067).
- (Position settings cannot exceed the specified position ranges.)

4.3.19 Teaching function

Related code
C001-C008 intelligent input terminals
P012: Control pulse setting
P013: Home search stop position setting

- The teaching function allows you to make the inverter run and stop the motor arbitrarily, and then store position data as a position command in an arbitrary position command area of memory.
- Assign function "45" (ORT) to an intelligent input terminal 1-8 (C001-C008). The ORT terminal functions as the teaching terminal when "02" (absolute position control) or "03" (high-resolution absolute position control) is specified for the control pulse setting (P012).

<Teaching procedure>

<1> Select the position command to be set by teaching selection (P074).

<2> Move the workpiece.

- Enter an operation command with the ORT terminal turned on. The speed and acceleration/deceleration settings selected at operation command input are applied.

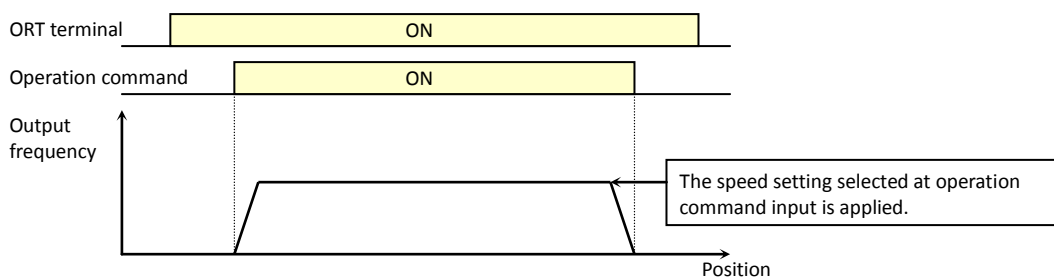

* Teaching operation can be performed when power is input to the power supply terminals (R0 and T0) of the inverter control circuit.

The current position counter also operates when an external device moves the workpiece. Therefore, teaching operation can also be performed when the inverter does not operate the machine.

Note: In the case above, make sure that the power supply to the power terminals (R, S, and T) of the inverter power circuit or inverter output (U, V, and W) is disconnected from the motor. Performing teaching operation with the power supply and inverter output connected may result in personal injury or damage to equipment.

<3> Press the STR key on the digital operator when the target position is reached. (Be sure to press when data is displayed (in case remote operator SRW-OJ, SRW-OEX is used, cursor is on the data value and PRG LED is on)

<4> The current position data is set in the memory area corresponding to the position command specified by the teaching selection (P074). (P074 itself is not stored. After power off or reset, 00 (X00) is set.)

Setting of P074	Position command to be set
00	P060: Multistage position setting 0
01	P061: Multistage position setting 1
02	P062: Multistage position setting 2
03	P063: Multistage position setting 3
04	P064: Multistage position setting 4
05	P065: Multistage position setting 5
06	P066: Multistage position setting 6
07	P067: Multistage position setting 7

4.3.20 Servo-on function

The servo-on function allows you to set the inverter in a speed-servo locking state with a signal input via an input terminal during operation. This function is effective when "05" (vector control with sensor) is specified as the V/F characteristic curve selection (A044).

To use this function, assign function "54" (SON) to an intelligent input terminal.

After the SON function has been assigned, the inverter accepts an operation command only when the SON terminal is on.

If the SON terminal is turned off while the inverter is operating the motor, the inverter sets the motor into the free-running state. If the SON terminal is subsequently turned on, the inverter restarts the motor according to the setting of the restart mode after FRS (b088).

This function cannot be used together with the forcing function (55: FOC). If both the FOC and SON functions are assigned to different intelligent input terminals, the FOC function has priority over the SON function (the SON function cannot be used).

Related code
 A044: V/F characteristic curve selection, 1st motor
 C001 to C008: Terminal [1] to [8] functions

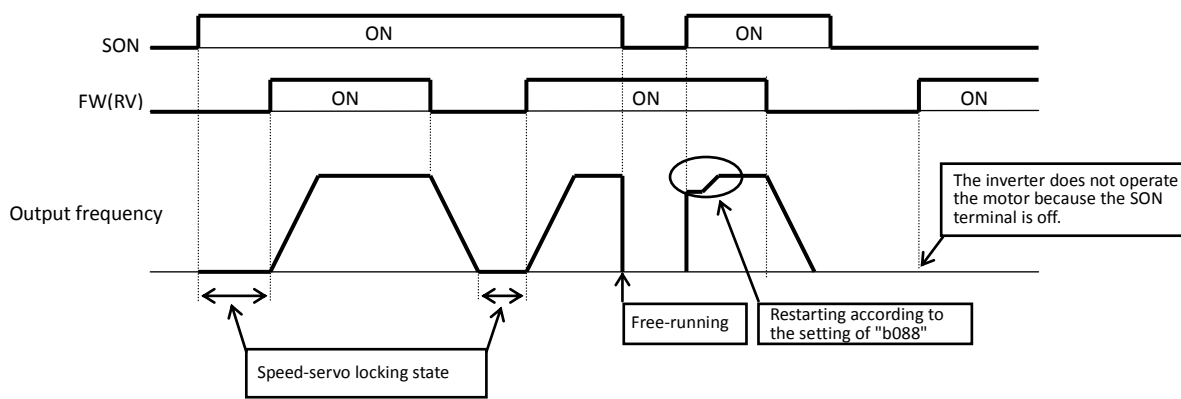

4.3.21 Pulse train frequency input

The pulse train frequency input function allows you to use the pulse train input via the SAP or SAN terminal as a frequency command or PID feedback data in each control mode. (You can use this function in every control mode.)

Specify the input frequency corresponding to the allowable maximum frequency as the pulse train frequency scale (P055).

You cannot use the start/end frequency setting function for external analog input together with this function. To limit the input frequency, specify the desired values for the pulse train frequency bias (P057) and pulse train frequency limit (P058).

Related code

P055: Pulse-string frequency scale
 P056: Time constant of pulse-string frequency filter
 P057: Pulse-string frequency bias
 P058: Pulse-string frequency limit
 A002: Frequency source setting
 A076: PV source setting
 A141: Operation-target frequency selection 1
 A142: Operation-target frequency selection 2

Item	Function code	Data or range of data	Description
Pulse train frequency scale	P055	1.0 to 50.0 (kHz)	Specification of the input frequency corresponding to the maximum allowable frequency
Time constant of pulse train frequency filter	P056	0.01 to 2.00 (s)	Setting of the filter time constant for the pulse train input
Pulse train frequency bias	P057	-100. to +100. (%)	
Pulse train frequency limit	P058	0. to 100. (%)	
Frequency source setting	A001	06	Settings for the frequency input as a pulse train
PV source setting	A076	03	
Operation-target frequency selection 1	A141	05	
Operation-target frequency selection 2	A142	05	

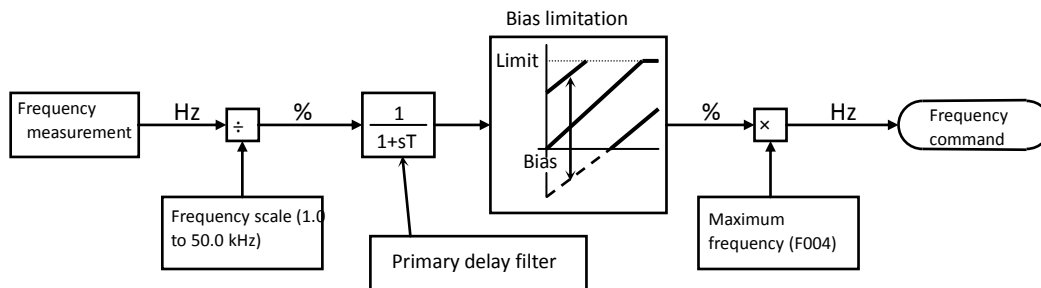

Block diagram for pulse train frequency input

4.4 Communication Functions

The inverter can engage in RS485 communications with an external control system that is connected to the TM2 terminal block (on the control circuit terminal block board) of the inverter.

The SJ700 series inverter shares the ASCII communication protocol with the SJ300 and L300P series inverters.

Related code

A001: Frequency source setting
 A002: Run command source setting
 C071: Communication speed selection
 C072: Node allocation
 C073: Communication data length selection
 C074: Communication parity selection
 C075: Communication stop bit selection
 C078: Communication wait time
 C079: Communication mode selection

(1) Communication specifications

Item	ASCII mode	Modbus-RTU mode	Remarks
Transmission speed	2,400, 4,800, 9,600, or 19,200 bps		Selection with the digital operator
Communication method	Half-duplex communication		
Synchronization method	Start-stop transmission	Asynchronous transmission	
Transmission code	ASCII code	Binary code	
Transmission method	Transmission beginning with the lowest-order bit		
Applicable interface	RS485		
Data bit length	7 or 8 bits	8 bits	Selection with the digital operator
Parity	No parity, even parity, or odd parity		Selection with the digital operator
Stop bit length	1 or 2 bits		Selection with the digital operator
Initiation method	Initiation only by a command from the external control system		
Waiting time	10 to 1,000 ms	0 to 1,000 ms	Setting with the digital operator
Connection format	1-to-N connection (N: Maximum of 32 [inverters])		Station number to be selected with the digital operator
Error check	Overrun, framing, BCC, vertical parity, and longitudinal parity errors	Overrun, framing, CRC-16, and longitudinal parity errors	

<Specifications and connections of RS485 ports>

For the RS485 communication function, use the TM2 terminal block on the control circuit terminal block board.

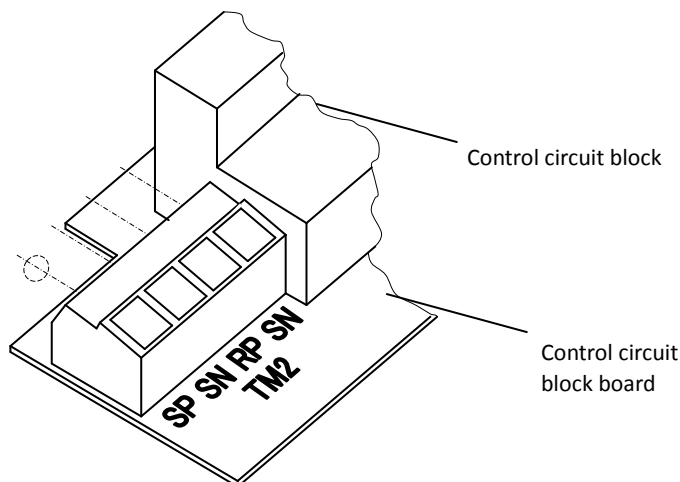

Abbreviated name of terminal	Description
SP	Positive signal terminal for transmission
SN	Negative signal terminal for transmission
RP	Terminal to enable the terminating resistor
SN	Terminal to enable the terminating resistor

Followings are recommended as the wire to connect TM2.

Solid-core wire $0.14\text{mm}^2\text{-}1.5\text{mm}^2$ (when two wires are on one terminal pole, $0.14\text{mm}^2\text{-}0.5\text{mm}^2$)

Standard wire $0.14\text{mm}^2\text{-}1.0\text{mm}^2$ (when two wires are on one terminal pole, $0.14\text{mm}^2\text{-}0.2\text{mm}^2$)

Standard wire with bar terminal $0.25\text{mm}^2\text{-}0.5\text{mm}^2$

Striped covering length 5mm

Screw torque 0.22Nm-0.25Nm (screw size M2)

Connection

As illustrated below, connect the inverters in parallel to the external control system, and connect the RP and SN terminals with a jumper on the inverter at the end of the network. (Similarly jumper the RP and SN terminals when only one inverter is connected to the external control system for RS485 communication.) Connecting the RP and SN terminals enables the terminating resistor in the control circuit terminal block board of the inverter, which suppresses signal reflections.

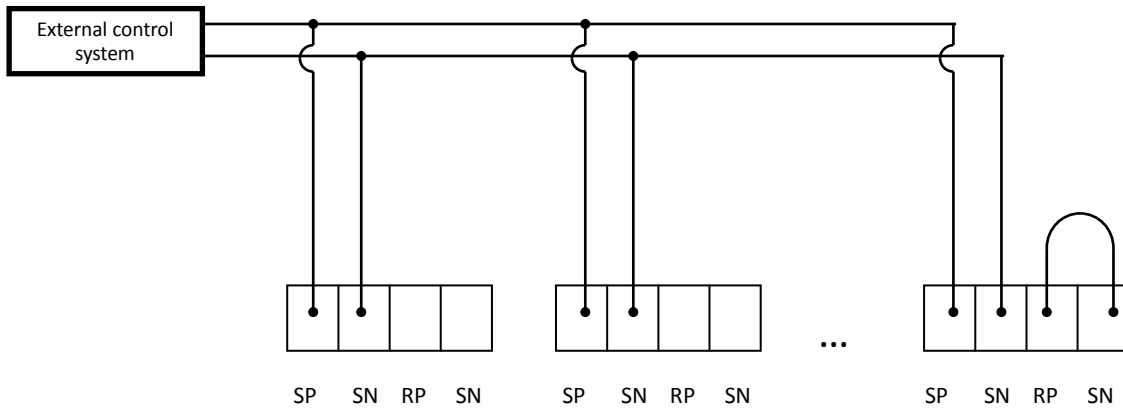

(2) Required settings

The following table lists the inverter settings required for the RS485 communication:

Item	Function code	Data or range of data	Description
Communication speed selection	C071	02	Loopback test
		03	2,400 bps
		04	4,800 bps
		05	9,600 bps
		06	19,200 bps
Node allocation	C072	1. to 32.	Assignment of a station number to the inverter (Set this item when your inverter is connected together with other(s) to a control system.)
Communication data length selection	C073	7	7 bits
		8	8 bits
Communication parity selection	C074	00	No parity
		01	Even parity
		02	Odd parity
Communication stop bit selection	C075	1	1 bit
		2	2 bits
Selection of operation after communication error	C076	00	Tripping
		01	Tripping after decelerating and stopping the motor
		02	Ignoring the errors
		03	Stopping the motor after free-running
		04	Decelerating and stopping the motor
Communication trip limit time setting	C077	0.00 to 99.99 (s)	Limit length of time to determine communication train disconnection
Communication wait time	C078	0. to 1000. (ms)	Time to wait until the inverter returns a response
Communication mode selection	C079	00	ASCII mode
		01	Modbus-RTU mode

(3) Communication test mode

- Use the communication test mode to check the hardware of the RS485 communication train.
- As for this function, communication mode selection (C079) is effective only at the time of ASCII mode (00).

(Procedure for communication test)

- 1) Remove all cables from the TM2 terminal block to perform a loopback test.
- 2) Make the following setting with the digital operator of the inverter:
 - Specify "02" (loopback test) for the communication speed selection (C071).
- 3) Turn the inverter power off once, and then turn it back on, whereupon the communication test begins.
- 4) After the test is completed, the inverter displays one of the following:

- When the communication is normal:



- When the communication train is abnormal:

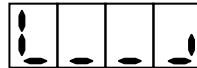

- 5) Press the STOP/RESET key of the digital operator or the reset button on the copy unit to switch to the normal setting screen. Using the setting screen, change the setting made in step 2) to that desired.

4.4.1 Communication in ASCII mode

(1) Communication protocol

The communication between the inverter and external control system is based on the following protocol:

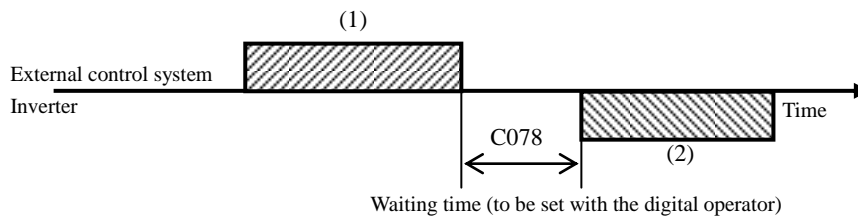

(1): Frame that is sent from the external control system to the inverter

(2): Frame that is sent from the inverter to the external control system

The inverter sends frame (2) as a response always after receiving frame (1). The inverter does not actively output any frame to the external control system.

The following table lists the frames (commands) used for communication:

Commands

Command	Function	Broadcast to all stations	Remarks
00	Instructs the inverter to drive the motor (for forward or reverse rotation) or stop the motor.	○	
01	Sets the inverter output frequency.	○	
02	Turns specified intelligent input terminals on or off.	○	
03	Reads all monitored data.	×	
04	Reads the inverter status.	×	
05	Reads a specified setting item.	×	
06	Writes data to a specified setting item.	×	
07	Initializes specified settings.	○	
08	Instructs the inverter to drive the motor (for forward or reverse rotation) or stop the motor.	○	This command can operate only when "01" or "02" has been specified for the initialization mode (b084). (Otherwise, only the trip history data is cleared.)
09	Checks whether set data can be stored in the EEPROM.	×	
0A	Stores set data in the EEPROM.	○	
0B	Recalculates the constants set in the inverter.	○	

The commands are described below.

- (i) 00 command: This command instructs the inverter to drive the motor (for forward or reverse rotation) or stop the motor. (To use this command, set "A002" to "03" [RS485].)

- Transmission frame

Frame format

STX	Station No.	Command	Data	BCC	CR
-----	-------------	---------	------	-----	----

	Description	Data size	Setting
STX	Control code (Start of TeXt)	1 byte	STX (0x02)
Station No.	Station number of control-target inverter	2 bytes	01 to 32, or FF (broadcast to all stations)
Command	Command to be transmitted	2 bytes	00
Data	Data to be transmitted	1 byte	See Note 1.
BCC	Block check code	2 bytes	XOR of the items from "Station No." to "Data." See Item (3) of this section.
CR	Control code (Carriage Return)	1 byte	CR (0x0D)

Note 1:

Data	Description	Remarks
0	Stop command	
1	Forward rotation command	
2	Reverse rotation command	

(Example) When sending a forward rotation command to the inverter with station No. 01:

(STX) |01|00|1| (BCC) | (CR) $\xrightarrow{\text{Conversion into ASCII format}}$ 02|30 31|30 30|31|33 30|0D

- Response frame

Positive response: See Item (2)-(i) of this section.

Negative response: See Item (2)-(ii) of this section.

- (ii) 01 command: This command sets the inverter output frequency. (To use this command, set "A001" to "03" [RS485].)

- Transmission frame

Frame format

STX	Station No.	Command	Data	BCC	CR
-----	-------------	---------	------	-----	----

	Description	Data size	Setting
STX	Control code (Start of TeXt)	1 byte	STX (0x02)
Station No.	Station number of control-target inverter	2 bytes	01 to 32, or FF (broadcast to all stations)
Command	Command to be transmitted	2 bytes	01
Data	Data to be sent (decimal ASCII code)	6 bytes	See Note 2.
BCC	Block check code	2 bytes	XOR of the items from "Station No." to "Data." See Item (3) of this section.
CR	Control code (Carriage Return)	1 byte	CR (0x0D)

Note 2: For example, to set the output frequency of the inverter with station No. 01 to 5 Hz, the data is as follows:

(STX) |01|01|000500| (BCC) | (CR) $\xrightarrow{\text{Conversion into ASCII format}}$ 02|30 31|30 31|30 30 30 35 30 30|30 35|0D

Note 3: The data indicates a value 100 times as large as the actual frequency value to be set.

(Example) 5 (Hz) → 500 → 000500 $\xrightarrow{\text{Conversion into ASCII format}}$ 30 30 30 35 30 30

Note 4: When using the data as the feedback data for PID control, set the most-significant byte to "1".

(Example) 5 (%) → 500 → 100500 $\xrightarrow{\text{Conversion into ASCII format}}$ 31 30 30 35 30 30

- Response frame

Positive response: See Item (2)-(i) of this section.

Negative response: See Item (2)-(ii) of this section.

(iii) 02, 12 command: This command turns the specified intelligent input terminals on or off.

- Transmission frame

Frame format

STX	Station No.	Command	Data	BCC	CR
-----	-------------	---------	------	-----	----

	Description	Data size	Setting
STX	Control code (Start of TeXt)	1 byte	STX (0x02)
Station No.	Station number of control-target inverter	2 bytes	01 to 32, or FF (broadcast to all stations)
Command	Command to be transmitted	2 bytes	02
Data	Data to be transmitted	16 bytes	See Note 5.
BCC	Block check code	2 bytes	XOR of the items from "Station No." to "Data." See Item (3) of this section.
CR	Control code (Carriage Return)	1 byte	CR (0x0D)

Note 5: The table below lists the functions of the intelligent input terminals and corresponding hexadecimal data. (For details, see the explanation of the intelligent input terminal functions.)

Data (hexadecimal)	Description	Data (hexadecimal)	Description
0000000000000001	FW: Forward rotation	0000000100000000	SF1: Multispeed bit 1
0000000000000002	RV: Reverse rotation	0000000200000000	SF2: Multispeed bit 2
0000000000000004	CF1: Multispeed 1 setting	0000000400000000	SF3: Multispeed bit 3
0000000000000008	CF2: Multispeed 2 setting	0000000800000000	SF4: Multispeed bit 4
0000000000000010	CF3: Multispeed 3 setting	0000001000000000	SF5: Multispeed bit 5
0000000000000020	CF4: Multispeed 4 setting	0000002000000000	SF6: Multispeed bit 6
0000000000000040	JG: Jogging	0000004000000000	SF7: Multispeed bit 7
0000000000000080	DB: External DC braking	0000008000000000	OLR: Overload restriction selection
0000000000000100	SET: Set 2nd motor data	0000010000000000	TL: Enabling /disabling torque limitation
0000000000000200	2CH: 2-stage acceleration/deceleration	0000020000000000	TRQ1: Torque limit selection bit 1
0000000000000400	-	0000040000000000	TRQ2: Torque limit selection bit 2
0000000000000800	FRS: Free-run stop	0000080000000000	PPI: P/PI mode selection
0000000000001000	EXT: External trip	0000100000000000	BOK: Braking confirmation
0000000000002000	USP: Unattended start protection	0000200000000000	ORT: Orientation
0000000000004000	CS: Commercial power source enable	0000400000000000	LAC: LAD cancellation
0000000000008000	SFT: Software lock	0000800000000000	PCLR: Clearance of position deviation
0000000000010000	AT: Analog input voltage/current select	0001000000000000	STAT: Pulse train position command input enable
0000000000020000	SET3: 3rd motor control	0002000000000000	-
0000000000040000	RS: Reset	0004000000000000	ADD: Trigger for frequency addition
0000000000080000	-	0008000000000000	F-TM: Forcible-terminal operation
0000000000100000	STA: Starting by 3-wire input	0010000000000000	ATR: Permission of torque command input
0000000000200000	STP: Stopping by 3-wire input	0020000000000000	KHC: Cumulative power clearance
0000000000400000	F/R: Forward/reverse switching by 3-wire input	0040000000000000	SON: Servo On
0000000000800000	PID: Enabling/disabling PID	0080000000000000	FOC: Forcing
0000000001000000	PIDC: PID reset	0100000000000000	MI1: General-purpose input 1
0000000002000000	-	0200000000000000	MI2: General-purpose input 2
0000000004000000	CAS: Control gain setting	0400000000000000	MI3: General-purpose input 3
0000000008000000	UP: Remote control UP function	0800000000000000	MI4: General-purpose input 4
0000000010000000	DWN: Remote control DOWN function	1000000000000000	MI5: General-purpose input 5
0000000020000000	DWN: Remote control data clearing	2000000000000000	MI6: General-purpose input 6
0000000040000000	-	4000000000000000	MI7: General-purpose input 7
0000000080000000	OPE: Forcible operation	8000000000000000	MI8: General-purpose input 8

Note 6: The table below lists the functions of the intelligent input terminals and corresponding hexadecimal data for 12 command. (For details, see the explanation of the intelligent input terminal functions.)

Data (hexadecimal)	Description	Data (hexadecimal)	Description
0000000000000001	-	0000001000000000	-
0000000000000002	AHD: analog command holding	0000002000000000	-
0000000000000004	CP1: multistage position settings selection 1	0000004000000000	-
0000000000000008	CP2: multistage position settings selection 2	0000008000000000	-
0000000000000010	CP3: multistage position settings selection 3	0000010000000000	-
0000000000000020	ORL: Zero-return limit function	0000020000000000	-
0000000000000040	ORG: Zero-return trigger function	0000040000000000	-
0000000000000080	FOT: forward drive stop	0000080000000000	-
0000000000000100	ROT: reverse drive stop	0000100000000000	-
0000000000000200	SPD: speed / position switching	0000200000000000	-
0000000000000400	PCNT: pulse counter	0000400000000000	-
0000000000000800	PCC: pulse counter clear	0000800000000000	-
0000000000001000	-	0001000000000000	-
0000000000002000	-	0002000000000000	-
0000000000004000	-	0004000000000000	-
0000000000008000	-	0008000000000000	-
0000000000010000	-	0010000000000000	-
0000000000020000	-	0020000000000000	-
0000000000040000	-	0040000000000000	-
0000000000080000	-	0080000000000000	-
0000000001000000	-	0100000000000000	-
0000000002000000	-	0200000000000000	-
0000000004000000	-	0400000000000000	-
0000000008000000	-	0800000000000000	-
0000000010000000	-	1000000000000000	-
0000000020000000	-	2000000000000000	-
0000000040000000	-	4000000000000000	-
0000000080000000	-	8000000000000000	-

(Example) When activating the "forward rotation," "Multispeed 1 setting," and "Multispeed 2 setting" settings on the inverter with station No. 01, specify the following in the Data part:

0x0000000000000001 + 0x0000000000000004 + 0x0000000000000008 = 0x000000000000000D

Consequently, the whole transmission frame is as follows:

(STX) |01|02|00000000000000D| (BCC) | (CR)

- Response frame

Positive response: See Item (2)-(i) of this section.

Negative response: See Item (2)-(ii) of this section.

(iv) 03 command: This command reads all monitored data from the inverter.

- Transmission frame

Frame format

STX	Station No.	Command	BCC	CR
-----	-------------	---------	-----	----

	Description	Data size	Setting
STX	Control code (Start of TeXt)	1 byte	STX (0x02)
Station No.	Station number of control-target inverter	2 bytes	01 to 32
Command	Command to be transmitted	2 bytes	03
BCC	Block check code	2 bytes	XOR of the items from "Station No." to "Data." See Item (3) of this section.
CR	Control code (Carriage Return)	1 byte	CR (0x0D)

- Response frame

Frame format

STX	Station No.	Data	BCC	CR
-----	-------------	------	-----	----

	Description	Data size	Setting
STX	Control code (Start of TeXt)	1 byte	STX (0x02)
Station No.	Station number of control-target inverter	2 bytes	01 to 32
Data	Data	104 bytes	See Note 7.
BCC	Block check code	2 bytes	XOR of the items from "Station No." to "Data." See Item (3) of this section.
CR	Control code (Carriage Return)	1 byte	CR (0x0D)

Note 7: Monitored data

Monitoring item	Unit	Magnification	Data size	Description	
Output frequency	Hz	×100	8 bytes	Decimal ASCII code	↑ High-order bytes Low-order bytes ↓
Output current	A	×10	8 bytes	Decimal ASCII code	
Rotation direction	-	-	8 bytes	"0" stopping, "1" (forward rotation), or "2" (reverse rotation)	
PID feedback data	%	×100	8 bytes	Decimal ASCII code	
Intelligent input terminal	-	-	8 bytes	See Note 7.	
Intelligent output terminal	-	-	8 bytes	See Note 8.	
Frequency conversion	-	×100	8 bytes	Decimal ASCII code	
Output torque	%	×1	8 bytes	Decimal ASCII code	
Output voltage	V	×10	8 bytes	Decimal ASCII code	
Electric power	kW	×10	8 bytes	Decimal ASCII code	
-	-	-	8 bytes	Always "00000000" (reserved for data storage)	
Cumulative running time	h	×1	8 bytes	Decimal ASCII code	
Cumulative power-on time	h	×1	8 bytes	Decimal ASCII code	

Note 8: Monitoring of intelligent input terminals

Terminal	Data
Terminal 1	00000001
Terminal 2	00000002
Terminal 3	00000004
Terminal 4	00000008
Terminal 5	00000010
Terminal 6	00000020
Terminal 7	00000040
Terminal 8	00000080
FW terminal	00000100

Note 8: Monitoring of intelligent output terminals

Terminal	Data
Terminal 11	00000001
Terminal 12	00000002
Terminal 13	00000004
Terminal 14	00000008
Terminal 15	00000010
Relay terminal	00000020

(v) 04 command: This command reads the status of the inverter.

- Transmission frame

Frame format

STX	Station No.	Command	BCC	CR
-----	-------------	---------	-----	----

	Description	Data size	Setting
STX	Control code (Start of TeXt)	1 byte	STX (0x02)
Station No.	Station number of control-target inverter	2 bytes	01 to 32
Command	Command to be transmitted	2 bytes	04
BCC	Block check code	2 bytes	XOR of the items from "Station No." to "Data." See Item (3) of this section.
CR	Control code (Carriage Return)	1 byte	CR (0x0D)

- Response frame

Frame format

STX	Station No.	Data	BCC	CR
-----	-------------	------	-----	----

	Description	Data size	Setting
STX	Control code (Start of TeXt)	1 byte	STX (0x02)
Station No.	Station number of control-target inverter	2 bytes	01 to 32
Data	Data	8 bytes	See Note 8.
BCC	Block check code	2 bytes	XOR of the items from "Station No." to "Data." See Item (3) of this section.
CR	Control code (Carriage Return)	1 byte	CR (0x0D)

Note 10: The data indicating the status of the inverter consists of the following three status elements (A, B, and C):

Data

Status A	Status B	Status C	00 (reserved)
----------	----------	----------	---------------

Inverter status A

Code	Status
00	Initial status
01	Stopping
02	Running
03	Free-run stop (FRS) in progress
04	Jogging (JG) in progress
05	DC braking (DB) in progress
06	Retry in progress
07	Tripping
08	Undervoltage (UV) status

Inverter status B

Code	Status
00	Stopping
01	Running
02	Tripping

Inverter status C

Code	Status
00	---
01	Stopping
02	Decelerating
03	Constant-speed operation
04	Accelerating
05	Forward operation
06	Reverse operation
07	Switching forward operation to reverse operation
08	Switching reverse operation to forward operation
09	Starting forward operation
10	Starting reverse operation

(vi) 05 command: This command reads the trip history data from the inverter.

- Transmission frame

Frame format

STX	Station No.	Command	BCC	CR
-----	-------------	---------	-----	----

	Description	Data size	Setting
STX	Control code (Start of TeXt)	1 byte	STX (0x02)
Station No.	Station number of control-target inverter	2 bytes	01 to 32
Command	Command to be transmitted	2 bytes	05
BCC	Block check code	2 bytes	XOR of the items from "Station No." to "Data." See Item (3) of this section.
CR	Control code (Carriage Return)	1 byte	CR (0x0D)

- Response frame

Frame format

STX	Station No.	Data	BCC	CR
-----	-------------	------	-----	----

	Description	Data size	Setting
STX	Control code (Start of TeXt)	1 byte	STX (0x02)
Station No.	Station number of control-target inverter	2 bytes	01 to 32
Data	Data monitored at tripping	440 bytes	See Note 9.
BCC	Block check code	2 bytes	XOR of the items from "Station No." to "Data." See Item (3) of this section.
CR	Control code (Carriage Return)	1 byte	CR (0x0D)

Note 11: The inverter stores the data (trip history) on the last six times of tripping, together with the total trip count (8 bytes).

Total trip count	Trip 1 data	• • • • •	Trip 6 data
------------------	-------------	-----------	-------------

Monitoring item	Unit	Magnification	Data size	Remarks	
Trip factor	-	-	8 bytes	Factor code	↑High-order bytes Low-order bytes↓
Inverter status A	-	-	8 bytes	04 command	
Inverter status B	-	-	8 bytes	See Note 7.	
Inverter status C	-	-	8 bytes		
Output frequency	Hz	×10	8 bytes	Decimal ASCII code	
Cumulative running time	hour	×1	8 bytes	Decimal ASCII code	
Output current	A	×10	8 bytes	Decimal ASCII code	
DC voltage	V	×10	8 bytes	Decimal ASCII code	
Cumulative power-on time	hour	×1	8 bytes	Decimal ASCII code	

(vii) 06 command: This command reads a specified setting item from the inverter.

- Transmission frame

Frame format

STX	Station No.	Command	Parameter	BCC	CR
-----	-------------	---------	-----------	-----	----

	Description	Data size	Setting
STX	Control code (Start of TeXt)	1 byte	STX (0x02)
Station No.	Station number of control-target inverter	2 bytes	01 to 32
Command	Command to be transmitted	2 bytes	06
Parameter	Data parameter number	4 bytes	See Note 12.
BCC	Block check code	2 bytes	XOR of the items from "Station No." to "Data." See Item (3) of this section.
CR	Control code (Carriage Return)	1 byte	CR (0x0D)

Note 12: The parameters that can be specified for reading are F002 to F004, A001 to A153, b001 to b132, C001 to C159, H003 to H073, and P001 to P131. (To read the F001 parameter, use the 01 command.)

- Response frame

Positive response:

Frame format

STX	Station No.	ACK	Data	BCC	CR
-----	-------------	-----	------	-----	----

	Description	Data size	Setting
STX	Control code (Start of TeXt)	1 byte	STX (0x02)
Station No.	Station number of control-target inverter	2 bytes	01 to 32
ACK	Control code (acknowledgement)	1 byte	ACK (0x06)
Data	Data to be sent (decimal ASCII code)	8 bytes	See Note 13.
BCC	Block check code	2 bytes	XOR of the items from "Station No." to "Data." See Item (3) of this section.
CR	Control code (Carriage Return)	1 byte	CR (0x0D)

Note 13: When the read parameter is an selection item, the Data part contains the code data corresponding to the selection.

The code data corresponding to "H003" or "H203" (motor capacity selection) is as follows:

Code data	00	01	02	03	04	05	06	07	08	09	10
Japan or U.S.A. mode (b085 = 00 or 02)	0.2 kW	-	0.4	-	0.75	-	1.5	2.2	-	3.7	-
EU mode (b085 = 01)	0.2 kW	0.37	-	0.55	0.75	1.1	1.5	2.2	3.0	-	4.0
Code data	11	12	13	14	15	16	17	18	19	20	21
Japan or U.S.A. mode (b085 = 00 or 02)	5.5 kW	7.5	11	15	18.5	22	30	37	45	55	75
EU mode (b085 = 01)	5.5 kW	7.5	11	15	18.5	22	30	37	45	55	75
Code data	22	23	24	25	26						
Japan or U.S.A. mode (b085 = 00 or 02)	90kW	110	132	150	160						
EU mode (b085 = 01)	90kW	110	132	150	160						

For the value contained in the Data part when the read parameter is a numerical item, see the list of function codes. (Example) When the setting of the acceleration (1) time (F002) is 30.00 seconds, the Data part contains "3000".

Negative response: See Item (2)-(ii) of this section.

(viii) 07 command: This command writes data to a specified setting item in the inverter.

- Transmission frame

Frame format

STX	Station No.	Command	Parameter	Data	BCC	CR
-----	-------------	---------	-----------	------	-----	----

	Description	Data size	Setting
STX	Control code (Start of TeXt)	1 byte	STX (0x02)
Station No.	Station number of control-target inverter	2 bytes	01 to 32, or FF (broadcast to all stations)
Command	Command to be transmitted	2 bytes	07
Parameter	Data parameter number	4 bytes	See Note 14.
Data	Parameter data (decimal ASCII code)	8 bytes	See Note 13.
BCC	Block check code	2 bytes	XOR of the items from "Station No." to "Data." See Item (3) of this section.
CR	Control code (Carriage Return)	1 byte	CR (0x0D)

Note 14: Possible range of parameters is as follows.

F002-, A001-, b001-, C001-, H001-, P001- (F001 is written with 01 command.)

- Response frame

Positive response: See Item (2)-(i) of this section.

Negative response: See Item (2)-(ii) of this section.

(ix) 08 command: This command initializes specified settings in the inverter.

The setting items to be initialized follow the setting of the initialization mode (b084). When "b084" is "00", the trip history data is cleared.

- Transmission frame

Frame format

STX	Station No.	Command	BCC	CR
-----	-------------	---------	-----	----

	Description	Data size	Setting
STX	Control code (Start of TeXt)	1 byte	STX (0x02)
Station No.	Station number of control-target inverter	2 bytes	01 to 32, or FF (broadcast to all stations)
Command	Command to be transmitted	2 bytes	08
BCC	Block check code	2 bytes	XOR of the items from "Station No." to "Data." See Item (3) of this section.
CR	Control code (Carriage Return)	1 byte	CR (0x0D)

- Response frame

Positive response: See Item (2)-(i) of this section.

Negative response: See Item (2)-(ii) of this section.

(x) 09 command: This command checks whether set data can be stored in the EEPROM in the inverter.

- Transmission frame

Frame format

STX	Station No.	Command	BCC	CR
-----	-------------	---------	-----	----

	Description	Data size	Setting
STX	Control code (Start of TeXt)	1 byte	STX (0x02)
Station No.	Station number of control-target inverter	2 bytes	01 to 32
Command	Command to be transmitted	2 bytes	09
BCC	Block check code	2 bytes	XOR of the items from "Station No." to "Data." See Item (3) of this section.
CR	Control code (Carriage Return)	1 byte	CR (0x0D)

- Response frame

Frame format

STX	Station No.	ACK	Data	BCC	CR
-----	-------------	-----	------	-----	----

	Description	Data size	Setting
STX	Control code (Start of TeXt)	1 byte	STX (0x02)
Station No.	Station number of control-target inverter	2 bytes	01 to 32
ACK	Control code (acknowledgement)	1 byte	ACK (0x06)
Data	Data	2 bytes	"01" (enabling data storage)
BCC	Block check code	2 bytes	XOR of the items from "Station No." to "Data." See Item (3) of this section.
CR	Control code (Carriage Return)	1 byte	CR (0x0D)

Negative response: See Item (4)-(ii) of this section.

(xi) 0A command: This command stores set data in the EEPROM in the inverter.

- Transmission frame

Frame format

STX	Station No.	Command	BCC	CR
-----	-------------	---------	-----	----

	Description	Data size	Setting
STX	Control code (Start of TeXt)	1 byte	STX (0x02)
Station No.	Station number of control-target inverter	2 bytes	01 to 32
Command	Command to be transmitted	2 bytes	0A
BCC	Block check code	2 bytes	XOR of the items from "Station No." to "Data." See Item (3) of this section.
CR	Control code (Carriage Return)	1 byte	CR (0x0D)

- Response frame

Positive response: See Item (2)-(i) of this section.

Negative response: See Item (2)-(ii) of this section.

(xii) 0B command: This command recalculates the constants set in the inverter.

This command must be issued when the base frequency or the setting of parameter "H***" has been changed for the RS485 communication.

- Transmission frame

Frame format

STX	Station No.	Command	BCC	CR
-----	-------------	---------	-----	----

	Description	Data size	Setting
STX	Control code (Start of TeXt)	1 byte	STX (0x02)
Station No.	Station number of control-target inverter	2 bytes	01 to 32
Command	Command to be transmitted	2 bytes	0B
BCC	Block check code	2 bytes	XOR of the items from "Station No." to "Data." See Item (3) of this section.
CR	Control code (Carriage Return)	1 byte	CR (0x0D)

- Response frame

Positive response: See Item (2)-(i) of this section.

Negative response: See Item (2)-(ii) of this section.

(2) Positive and negative responses

(i) Positive response

- Response frame

Frame format

STX	Station No.	ACK	BCC	CR
-----	-------------	-----	-----	----

	Description	Data size	Setting
STX	Control code (Start of TeXt)	1 byte	STX (0x02)
Station No.	Station number of control-target inverter	2 bytes	01 to 32
ACK	Control code (acknowledgement)	1 byte	ACK (0x06)
BCC	Block check code	2 bytes	XOR of the items from "Station No." to "ACK." See Item (3) of this section.
CR	Control code (Carriage Return)	1 byte	CR (0x0D)

(ii) Negative response

- Response frame

Frame format

STX	Station No.	NAK	Error code	BCC	CR
-----	-------------	-----	------------	-----	----

	Description	Data size	Setting
STX	Control code (Start of TeXt)	1 byte	STX (0x02)
Station No.	Station number of control-target inverter	2 bytes	01 to 32
NAK	Control code (negative acknowledgement)	1 byte	NAK (0x15)
Error code	Content of communication error	2 bytes	See Note 13.
BCC	Block check code	2 bytes	XOR of the items from "Station No." to "Error code." See Item (3) of this section.
CR	Control code (Carriage Return)	1 byte	CR (0x0D)

Note 15: Error codes

Error code	Description
01H	Parity error
02H	Sum check error
03H	Framing error
04H	Overrun
05H	Protocol error
06H	ASCII code error
07H	Receiving-buffer overflow
08H	Reception timeout
-	-
-	-
11H	Command error
12H	-
13H	Execution disabled
14H	-
15H	-
16H	Parameter error
17H	-

If a command is broadcasted to all inverter stations, no response will be returned to the external control system.

(3) How to calculate the block check code (BCC)

(Example) When using the 01 command (frequency-setting command) to set the inverter output frequency to 5 Hz (the station No. of the inverter is 01):

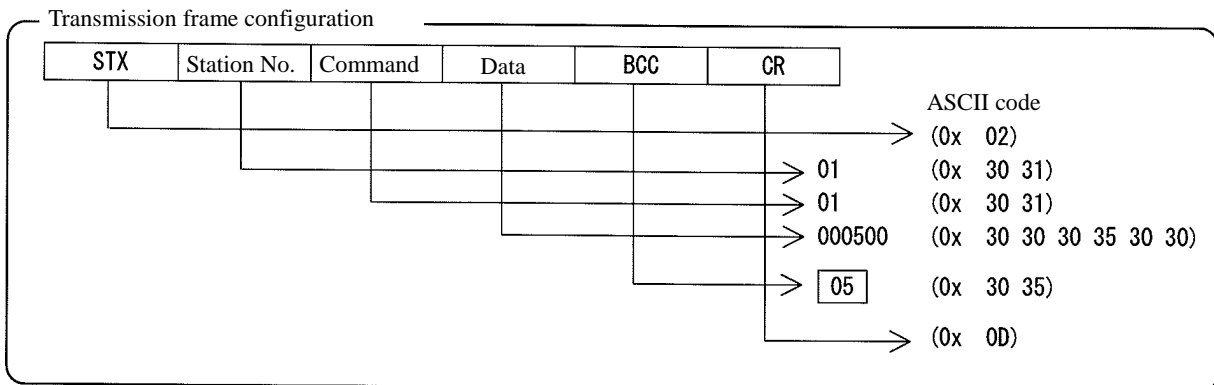

The contents of "Station No." to "Data" are converted into ASCII data, and the ASCII data is XORed bit by bit. The final XOR result is set as the block check code (BCC). In the above example of transmission frame, BCC is calculated as follows:

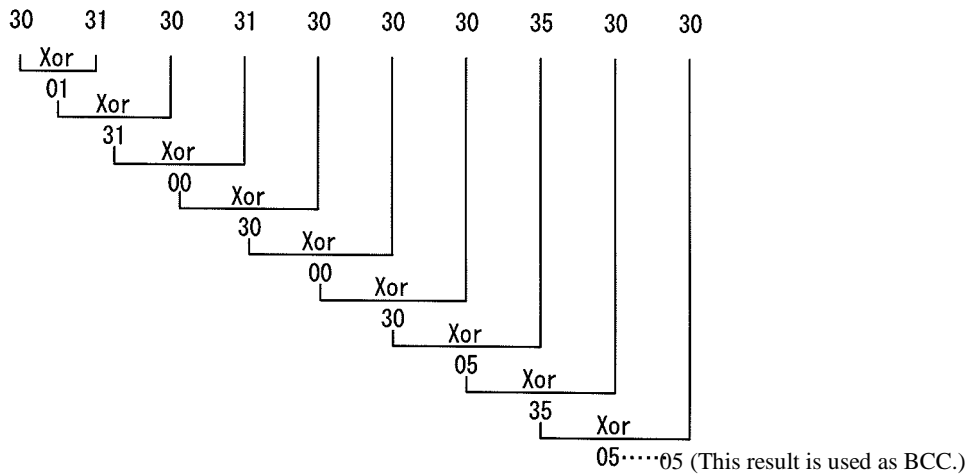

(Reference) ASCII code conversion table

Character data	ASCII code
STX	2
ACK	6
CR	0D
NAK	15
0	30
1	31
2	32
3	33
4	34
5	35
6	36
7	37
8	38
9	39

Character data	ASCII code
A	41
B	42
C	43
D	44
E	45
F	46
H	48
P	50
b	62

4.4.2 Communication in Modbus-RTU mode

(1) Communication protocol

The communication between the inverter (slave) and external control system (master) is based on the following protocol:

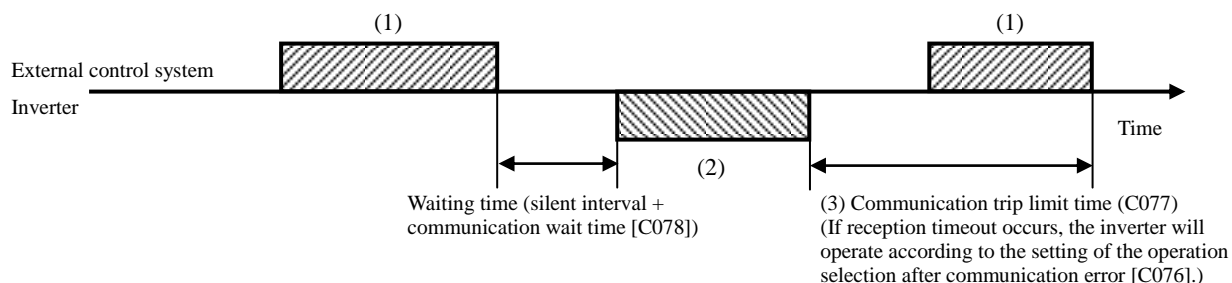

(1): Query frame that is sent from the external control system to the inverter

(2): Response frame that is sent from the inverter to the external control system

(3): Communication trip limit time (C077)

If the inverter cannot complete the reception of a query from the master system (external control system) within the communication trip limit time, after having sent a response to the preceding query, the inverter enters the status in which to receive the query from the beginning. Subsequently, the inverter returns no response to the master system.

After reception timeout occurs, the inverter operates according to the setting of the selection of operation after communication error (C076). For details, see the table below. Monitoring of reception timeout begins when the first communication is performed after the inverter power has been turned on or the inverter has been reset. Reception timeout is monitored only when the inverter communicates with the master system.

Item	Function code	Range of data	Description
Selection of operation after communication error	C076	00: Tripping	The inverter trips (E41) after reception timeout.
		01: Tripping after stopping the motor	The inverter decelerates and stops the motor, and then trips (E41) after reception timeout.
		02: Ignoring the errors	The inverter ignores the error without tripping and alarm output.
		03: Stopping the motor after free-running (FRS)	The inverter stops the motor after free-running without tripping and alarm output after reception timeout.
		04: Decelerating and stopping the motor	The inverter decelerates and stops the motor without tripping and alarm output after reception timeout.
Communication trip limit time setting	C077	0.00 to 99.99 (s)	Limit time to determine the reception timeout
Communication wait time	C078	0. to 1000. (ms)	Time to wait until the inverter starts sending a response after reception of a query (excluding the silent interval)

The inverter sends a response (frame (2)) always after receiving a query (frame (1)). The inverter does not actively output any frame to the external control system.

The formats of the query and response frames are described below.

Message configuration: Query

Header (silent interval)
Slave address
Function code
Data
Error check code
Trailer (silent interval)

(i) Slave address

The slave address is a number 1 to 32 that is assigned to the inverter (slave) beforehand. (A query is received by the inverter having the same slave address as that specified in the query.)

The query with the slave address set to "0" is broadcasted to all the connected inverters.

With a broadcast query, the master system can neither read inverter data nor perform a loopback test.

(ii) Data

The data contains a functional instruction.

The SJ700 series inverter supports the following Modbus data format:

Data name	Description
Coil data	1-bit binary data that can be referenced and changed
Register data	16-bit data that can be referenced and changed

(iii) Function code

The function code specifies the function to be executed by the inverter.

The table below lists the function codes supported by the SJ700 series inverter.

Function codes

Function code	Function	Maximum number of data bytes in a message	Maximum data count in a message
01h	Reads the coil status.	4	32 coils (in units of bit)
03h	Reads registers.	8	4 registers (in units of byte)
05h	Writes data to a coil.	2	1 coil (in units of bit)
06h	Writes data to a register.	2	1 register (in units of byte)
08h	Performs a loopback test.	-	
0Fh	Writes data to multiple coils.	4	32 coils (in units of bit)
10h	Writes data to multiple registers.	8	4 registers (in units of byte)

(iv) Error check code

The Modbus-RTU protocol uses the cyclic redundancy check (CRC) as the error check method.

The CRC code is the 16-bit data generated for a data block that has an arbitrary data length (in units of 8 bits).

A generative polynomial for CRC-16 ($X^{16} + X^{15} + X^2 + 1$) is used to generate the CRC code.

Example of CRC-16 calculation

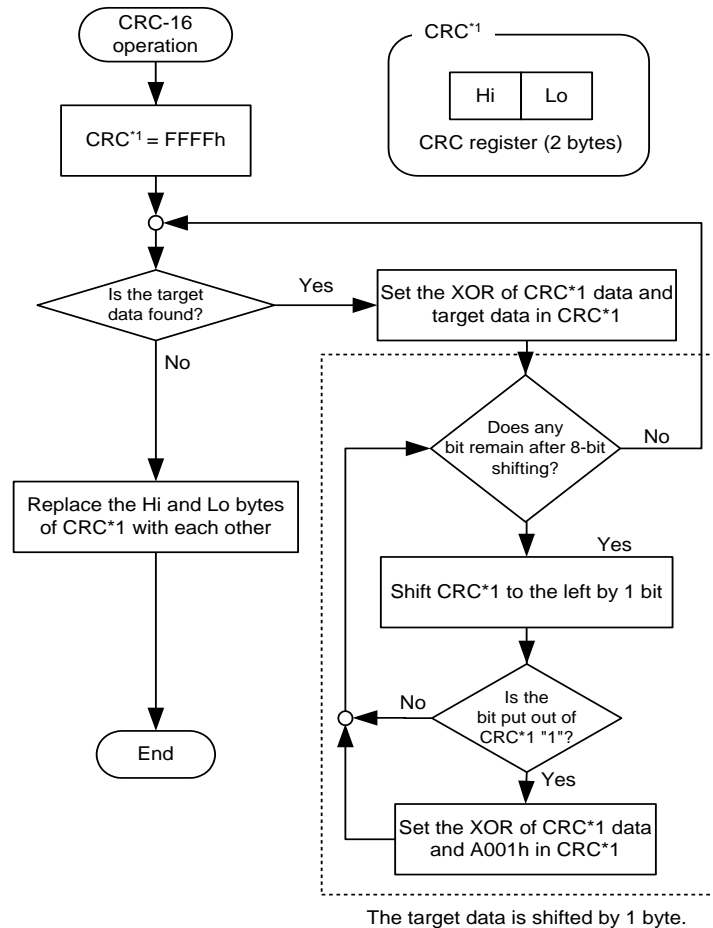

(v) Header and trailer (silent interval)

The header and trailer set the total time the inverter should wait before sending a response after having received a query from the master system.

Be sure to specify the time corresponding to the transmission of 3.5 characters (24 bits) as the waiting time. If a shorter waiting time (corresponding to the transmission of fewer than 3.5 characters) is specified, the inverter will not respond.

The actual waiting time is the sum of the silent interval (corresponding to the transmission of 3.5 characters) and the communication wait time (C078).

Message configuration: Response

(i) Time required for communication

After the inverter receives a query, the inverter waits for the sum of the silent interval (corresponding to the transmission of 3.5 characters) and the communication wait time (C078) before sending a response.

After receiving a response from the inverter, the master system must wait for the silent interval (corresponding to the transmission of 3.5 characters) or longer before sending the next query to the inverter.

(ii) Normal response

If the query specifies the function code (08h) for the loopback test, the inverter returns a response that has the same contents as the query.

If the query specifies a function code (05h, 06h, 0Fh, or 10h) for writing data to registers or coils, the inverter returns the query without a change as a response.

If the query specifies a function code (01h or 03h) for reading a register or coil, the inverter returns a response that contains the slave address and function code specified in the query and the data read from the register or coil.

(iii) Response upon error

Field configuration

Slave address
Function code
Exception code
CRC-16

If the query includes an error (other than a communication error), the inverter returns an exception response without executing the function specified by the query.

To know the error, check the function code set in the exception response. The exception response in reply to a query includes a function code that is the sum of "80h" and the function code specified by the query.

The exception code in the exception response indicates the content of the error.

Exception codes

Code	Description
01h	An unsupported function is specified.
02h	The specified address is not found.
03h	The specified data has an unacceptable format.
21h	The data to be written to a register exceeds the range of inverter specifications.
22h	The inverter restricts the execution of the specified function: - Rewriting a register that cannot be rewritten during the operation - Issuing an Enter command during the operation (in undervoltage status) - Writing to a register during tripping (because of undervoltage) - Writing to a read-only register (coil)

(iv) No response

The inverter ignores a query without returning any response if:

- the query is a broadcast query,
- a communication occurs during the reception of the query,
- the slave address specified in the query differs from that of the inverter,
- the time interval between data items in the query message is less than the time corresponding to the transmission of 3.5 characters, or
- the data length of the query is invalid.

Note: In the master system, set a timer to monitor the responses from the inverter, and configure the master system so that, when the inverter does not return the response to a query within a specified limit time, the master system resends the query.

(4) Explanation of function codes

(i) Reading the coil status [01h]

This function reads the coil status (on or off).

(Example)

When reading the status of the intelligent input terminals [1] to [6] of the inverter at slave address "8":

Assume that the intelligent input terminals are in the status as shown below.

Intelligent input terminal	1	2	3	4	5	6
Coil number	7	8	9	10	11	12
Terminal status	ON	ON	ON	OFF	ON	OFF

Coils 13 and 14 are off.

Query

Field name	Sample setting (hexadecimal)
1 Slave address (*1)	08
2 Function code	01
3 Starting coil number (upper digit) (*2)	00
4 Starting coil number (lower digit) (*2)	06
5 Number of coils (upper digit) (*3)	00
6 Number of coils (lower digit) (*3)	06
7 CRC-16 code (upper digit)	5C
8 CRC-16 code (lower digit)	90

Response

Field name	Sample setting (hexadecimal)
1 Slave address	08
2 Function code	01
3 Number of data bytes	01
4 Coil data (*4)	17
5 CRC-16 code (upper digit)	12
6 CRC-16 code (lower digit)	1A

*4 The data as many as the specified number of data bytes is transferred.

*1 This query cannot be broadcasted.

*2 Note that the starting coil number is 1 less than the actual coil number of the coil to be read first.

*3 If 0 or a value more than 32 is specified as the number of coils to be read, the inverter will respond with error code "03h".

The data received in the response indicates the status of coils 7 to 14. Read the received data (17h = 00010111b) as shown below. The least-significant bit indicates the status of coil 7.

Coil number	14	13	12	11	10	9	8	7
Coil status	OFF	OFF	OFF	ON	OFF	ON	ON	ON

If the query has specified the reading of an undefined coil, the data on the said coil is represented by "0" in the response.

If the function to read the coil status cannot be executed normally, the inverter will return an exception response. For details, see Item (viii), "Exception response."

(ii) Reading registers [03h]

This function reads a specified number of registers beginning at a specified register address.

(Example)

When reading the trip history data from the inverter at slave address "5":

Assume that the conditions of the past three trips are as follows:

SJ700 command	d081 (factor of most recent trip)	d081 (inverter state at most recent trip)
Register number	0012h	0013h
Trip factor (upper digit)	Overvoltage (E07)	Decelerating (02)

Query

	Field name	Sample setting (hexadecimal)
1	Slave address (*1)	05
2	Function code	03
3	Starting register number (upper digit) (*2)	00
4	Starting register number (lower digit) (*2)	11
5	Number of registers (upper digit)	00
6	Number of registers (lower digit)	02
7	CRC-16 code (upper digit)	95
8	CRC-16 code (lower digit)	8A

*1 This query cannot be broadcasted.

*2 Note that the starting coil number is 1 less than the actual coil number of the coil to be read first.

Response

	Field name	Sample setting (hexadecimal)
1	Slave address	05
2	Function code	03
3	Number of data bytes (*3)	04
4	Starting register number (upper digit)	00
5	Starting register number (lower digit)	07
6	Starting register number + 1 (upper digit)	00
7	Starting register number + 1 (lower digit)	02
8	CRC-16 code (upper digit)	36
9	CRC-16 code (lower digit)	37

*3 The data equivalent to the specified number of data bytes is transferred. In this example, 4 bytes are transferred because the data on two registers is returned in the response.

Read the data received in the response as follows:

Response buffer	4	5	6	7
Starting register number	+0 (upper digit)	+0 (lower digit)	+1 (upper digit)	+1 (lower digit)
Response data	00h	07h	00h	02h
Trip condition	Trip due to overvoltage		Decelerating	

If the function to read registers cannot be executed normally, the inverter will return an exception response. For details, see Item (viii), "Exception response."

(iii) Writing data to a specified coil [05h]

This function writes data to a specified coil

The following table shows the updating of the coil status.

	Coil status	
	OFF→ON	ON→OFF
Updating data (upper digit)	FFh	00h
Updating data (lower digit)	00h	00h

(Example)

When sending an operation command to the inverter at slave address "10":

To start the inverter operation, "03" must be set in parameter "A002". Coil 1 is used to turn on an operation command.

Query			Response		
	Field name	Sample setting (hexadecimal)		Field name	Sample setting (hexadecimal)
1	Slave address (*1)	0A	1	Slave address	0A
2	Function code	05	2	Function code	05
3	Starting coil number (upper digit) (*2)	00	3	Starting coil number (upper digit)	00
4	Starting coil number (lower digit) (*2)	00	4	Starting coil number (lower digit)	00
5	Updating data (upper digit)	FF	5	Updating data (upper digit)	FF
6	Updating data (lower digit)	00	6	Updating data (lower digit)	00
7	CRC-16 code (upper digit)	8D	7	CRC-16 code (upper digit)	8D
8	CRC-16 code (lower digit)	41	8	CRC-16 code (lower digit)	41

*1 If this query is broadcasted, no inverter will return any response.

*2 Note that the starting coil number is 1 less than the actual coil number of the coil to be read first.

If the function to write data to a coil cannot be executed normally, the inverter will return an exception response. For details, see Item (viii), "Exception response."

(iv) Writing data to a specified register [06h]

This function writes data to a specified register.

(Example)

When setting "50 Hz" as the base frequency setting (A003) in the inverter at slave address "5":

Since register "1203h" to store the base frequency setting (A003) has a data resolution of 1 Hz, specify "50" (0032h) as the updating data to set "50 Hz".

Query			Response		
	Field name	Sample setting (hexadecimal)		Field name	Sample setting (hexadecimal)
1	Slave address (*1)	05	1	Slave address	05
2	Function code	06	2	Function code	06
3	Starting register number (upper digit) (*2)	12	3	Starting register number (upper digit)	12
4	Starting register number (lower digit) (*2)	02	4	Starting register number (lower digit)	02
5	Updating data (upper digit)	00	5	Updating data (upper digit)	00
6	Updating data (lower digit)	32	6	Updating data (lower digit)	32
7	CRC-16 code (upper digit)	AD	7	CRC-16 code (upper digit)	AD
8	CRC-16 code (lower digit)	23	8	CRC-16 code (lower digit)	23

*1 If this query is broadcasted, no inverter will return any response.

*2 Note that the starting coil number is 1 less than the actual coil number of the coil to be read first.

If the function to write data to a specified register cannot be executed normally, the inverter will return an exception response. For details, see Item (viii), "Exception response."

(v) Performing a loopback test [08h]

The loopback test function is used to check the communication between the external control system (master) and the inverter (slave).

(Example)

When performing a loopback test with the inverter at slave address "1":

Query

	Field name	Sample setting (hexadecimal)
1	Slave address (*1)	01
2	Function code	08
3	Diagnosis subcode (upper digit)	00
4	Diagnosis subcode (lower digit)	00
5	Data (upper digit)	Arbitrary
6	Data (lower digit)	Arbitrary
7	CRC-16 code (upper digit)	CRC
8	CRC-16 code (lower digit)	CRC

Response

	Field name	Sample setting (hexadecimal)
1	Slave address	01
2	Function code	08
3	Diagnosis subcode (upper digit)	00
4	Diagnosis subcode (lower digit)	00
5	Data (upper digit)	Arbitrary
6	Data (lower digit)	Arbitrary
7	CRC-16 code (upper digit)	CRC
8	CRC-16 code (lower digit)	CRC

*1 This query cannot be broadcasted.

The diagnosis subcode only conforms to the echoing of query data (00h, 00h). It cannot be used for other commands.

(vi) Writing data to multiple coils [0Fh]

This function rewrites data in sequential coils.

(Example)

When updating the status of the intelligent input terminals [1] to [6] of the inverter at slave address "5":

The status of the intelligent input terminals is updated to the status shown in the following table:

Intelligent input terminal	1	2	3	4	5	6
Coil number	7	8	9	10	11	12
Terminal status	ON	ON	ON	OFF	ON	OFF

Query

	Field name	Sample setting (hexadecimal)
1	Slave address (*1)	05
2	Function code	0F
3	Starting coil number (upper digit) (*2)	00
4	Starting coil number (lower digit) (*2)	06
5	Number of coils (upper digit)	00
6	Number of coils (lower digit)	06
7	Number of data bytes (*3)	02
8	Updating data (upper digit) (*3)	17
9	Updating data (lower digit) (*3)	00
10	CRC-16 code (upper digit)	DB
11	CRC-16 code (lower digit)	3E

Response

	Field name	Sample setting (hexadecimal)
1	Slave address	05
2	Function code	0F
3	Starting coil number (upper digit)	00
4	Starting coil number (lower digit)	06
5	Number of coils (upper digit)	00
6	Number of coils (lower digit)	06
7	CRC-16 code (upper digit)	34
8	CRC-16 code (lower digit)	4C

*1 If this query is broadcasted, no inverter will return any response.

*2 Note that the starting coil number is 1 less than the actual coil number of the coil to which the data is to be written first.

*3 The updating data consists of the upper and lower digits. Even when updating an odd number of data bytes, add 1 to the number of data bytes to make it an even number before specifying the number of data bytes.

If the function to write data to multiple coils cannot be executed normally, the inverter will return an exception response. For details, see Item (viii), "Exception response."

(vii) Writing data to multiple registers [10h]

This function writes data to sequential registers.

(Example)

When setting "3,000 Hz" as the Acceleration (1) time (F002) in the inverter at slave address "1":

Since register "1103h" and "1104h" to store the Acceleration (1) time (F002) have a data resolution of 0.01 seconds, specify "300000" (493E0h) as the updating data to set "3,000 seconds".

Query		Response	
Field name	Sample setting (hexadecimal)	Field name	Sample setting (hexadecimal)
1 Slave address (*1)	01	1 Slave address (*1)	01
2 Function code	10	2 Function code	10
3 Starting register address (upper digit) (*2)	11	3 Starting register address (upper digit) (*2)	11
4 Starting register address (lower digit) (*2)	02	4 Starting register address (lower digit) (*2)	02
5 Number of registers (upper digit)	00	5 Number of registers (upper digit)	00
6 Number of registers (lower digit)	02	6 Number of registers (lower digit)	02
7 Number of data bytes (*3)	04	7 CRC-16 code (upper digit)	E5
8 Updating data 1 (upper digit)	00	8 CRC-16 code (lower digit)	34
9 Updating data 1 (lower digit)	04		
10 Updating data 2(upper digit)	93		
11 Updating data 2(lower digit)	E0		
12 CRC-16 code (upper digit)	9E		
13 CRC-16 code (lower digit)	9F		

*1 If this query is broadcasted, no inverter will return any response.

*2 Note that the starting register address is 1 less than the actual address of the register to which the data is to be written first.

*3 As the number of bytes, do not specify the number of registers but the number of bytes to be actually updated.

If the function to write data to multiple registers cannot be executed normally, the inverter will return an exception response. For details, see Item (viii), "Exception response."

(viii) Exception response

The master system requests the inverter (slave) to return a response upon reception of a query other than broadcasted queries. The inverter must return the response that matches the query it has received. However, if an error is found in a query, the inverter will return an exception response.

The exception response consists of the following fields:

Field configuration

Slave address
Function code
Exception code
CRC-16 code

Details of the field configuration are described below. The exception response in reply to a query includes a function code that is the sum of "80h" and the function code specified by the query. The exception code in the exception response indicates the content of the error.

Function codes

Query	Exception response
01h	81h
03h	83h
05h	85h
06h	86h
0Fh	8Fh
10h	90h

Exception codes

Code	Description
01h	An unsupported function is specified.
02h	The specified address is not found.
03h	The specified data has an unacceptable format.
21h	The data to be written to a register exceeds the range of inverter specifications.
22h	The inverter restricts the execution of the specified function: <ul style="list-style-type: none"> - Rewriting a register that cannot be rewritten during the operation - Issuing an Enter command during the operation (in undervoltage status) - Writing to a register during tripping (because of undervoltage) - Writing to a read-only register (coil)

(5) Enter command (storing the updates of register data)

Neither the command (06h) to write data to a register nor the command (10h) to write data to multiple registers can store the updates they made in the internal memory of the inverter. Turning the inverter power off without storing the updates deletes them and restores the original register settings. If you intend to store register updates in the internal memory of the inverter, issue the Enter command as described below.

If you have updated a control constant, you must recalculate the motor constants. In such cases, use register "0900h" for recalculation as described below.

How to issue the Enter command

With the command (06h) to write data to registers, write all register data to the internal memory. To recalculate the motor constants, use the same command to write the data shown in the following table to register "0900h":

Data to be written	Description
0000	Recalculating the motor constants
0001	Storing the register data
Other than the above	Recalculating the motor constants and storing the register data

Notes:

- Execution of the Enter command requires considerable time. To check whether data writing is in progress, monitor the status of the signal (coil No. 001Ah) that indicates whether data writing is in progress.
- The internal memory device of the inverter is subject to a limitation on the number of rewriting operations (about 100,000 times). Frequent use of the Enter command may shorten the inverter life.

(6) List of registers

The "R/W" column of the list indicates whether the coils and registers are read-only or readable and writable. "R" indicates a read-only coil or register. "R/W" indicates a readable and writable coil or register.

(i) List of coils

Coil No.	Item	R/W	Setting
0000h	(Reserved)	-	
0001h	Operation command	R/W	1: Run, 0: Stop (valid when A002 = 03)
0002h	Rotation direction command	R/W	1: Reverse rotation, 0: Forward rotation (valid when A002 = 03)
0003h	External trip (EXT)	R/W	1: Trip
0004h	Trip reset (RS)	R/W	1: Reset
0005h	(Reserved)	-	
0006h	(Reserved)	-	
0007h	Intelligent input terminal [1]	R/W	1: ON, 0: OFF (*1)
0008h	Intelligent input terminal [2]	R/W	1: ON, 0: OFF (*1)
0009h	Intelligent input terminal [3]	R/W	1: ON, 0: OFF (*1)
000Ah	Intelligent input terminal [4]	R/W	1: ON, 0: OFF (*1)
000Bh	Intelligent input terminal [5]	R/W	1: ON, 0: OFF (*1)
000Ch	Intelligent input terminal [6]	R/W	1: ON, 0: OFF (*1)
000Dh	Intelligent input terminal [7]	R/W	1: ON, 0: OFF (*1)
000E h	Intelligent input terminal [8]	R/W	1: ON, 0: OFF (*1)
000Fh	Operation status	R	1: Run, 0: Stop (interlocked to "d003")
0010h	Rotation direction	R	1: Reverse rotation, 0: Forward rotation (interlocked to "d003")
0011h	Inverter ready	R	1: Ready, 0: Not ready
0012h	Unused	R	
0013h	RUN (running)	R	1: Tripping, 0: Normal
0014h	FA1 (constant-speed reached)	R	1: ON, 0: OFF
0015h	FA2 (set frequency overreached)	R	1: ON, 0: OFF
0016h	OL (overload notice advance signal (1))	R	1: ON, 0: OFF
0017h	OD (output deviation for PID control)	R	1: ON, 0: OFF
0018h	AL (alarm signal)	R	1: ON, 0: OFF
0019h	FA3 (set frequency reached)	R	1: ON, 0: OFF
001Ah	OTQ (over-torque)	R	1: ON, 0: OFF
001Bh	IP (instantaneous power failure)	R	1: ON, 0: OFF
001Ch	UV (undervoltage)	R	1: ON, 0: OFF
001Dh	TRQ (torque limited)	R	1: ON, 0: OFF
001Eh	RNT (operation time over)	R	1: ON, 0: OFF
001Fh	ONT (plug-in time over)	R	1: ON, 0: OFF
0020h	THM (thermal alarm signal)	R	1: ON, 0: OFF
0021h	(Reserved)	-	
0022h	(Reserved)	-	
0023h	(Reserved)	-	
0024h	(Reserved)	-	
0025h	(Reserved)	-	
0026h	BRK (brake release)	R	1: ON, 0: OFF
0027h	BER (brake error)	R	1: ON, 0: OFF
0028h	ZS (0 Hz detection signal)	R	1: ON, 0: OFF
0029h	DSE (speed deviation maximum)	R	1: ON, 0: OFF
002Ah	POK (positioning completed)	R	1: ON, 0: OFF
002Bh	FA4 (set frequency overreached 2)	R	1: ON, 0: OFF
002Ch	FA5 (set frequency reached 2)	R	1: ON, 0: OFF
002Dh	OL2 (overload notice advance signal (2))	R	1: ON, 0: OFF
002Eh	Odc: Analog O disconnection detection	-	
002Fh	OIDc: Analog OI disconnection detection	-	
0030h	O2Dc: Analog O2 disconnection detection	-	
0031h	(Reserved)	-	
0032h	FBV (PID feedback comparison)	R	1: ON, 0: OFF
0033h	NDC (communication train disconnection)	R	1: ON, 0: OFF
0034h	LOG1 (logical operation result 1)	R	1: ON, 0: OFF

Coil No.	Item	R/W	Setting
0035h	LOG2 (logical operation result 2)	R	1: ON, 0: OFF
0036h	LOG3 (logical operation result 3)	R	1: ON, 0: OFF
0037h	LOG4 (logical operation result 4)	R	1: ON, 0: OFF
0038h	LOG5 (logical operation result 5)	R	1: ON, 0: OFF
0039h	LOG6 (logical operation result 6)	R	1: ON, 0: OFF
003Ah	WAC (capacitor life warning)	R	1: ON, 0: OFF
003Bh	WAF (cooling-fan speed drop)	R	1: ON, 0: OFF
003Ch	FR (starting contact signal)	R	1: ON, 0: OFF
003Dh	OHF (heat sink overheat warning)	R	1: ON, 0: OFF
003Eh	LOC (low-current indication signal)	R	1: ON, 0: OFF
003Fh	M01 (general output 1)	R	1: ON, 0: OFF
0040h	M02 (general output 2)	R	1: ON, 0: OFF
0041h	M03 (general output 3)	R	1: ON, 0: OFF
0042h	M04 (general output 4)	R	1: ON, 0: OFF
0043h	M05 (general output 5)	R	1: ON, 0: OFF
0044h	M06 (general output 6)	R	1: ON, 0: OFF
0045h	IRDY (inverter ready)	R	1: ON, 0: OFF
0046h	FWR (forward rotation)	R	1: ON, 0: OFF
0047h	RVR (reverse rotation)	R	1: ON, 0: OFF
0048h	MJA (major failure)	R	1: ON, 0: OFF
0049h	Data writing in progress	R	1: Writing in progress, 0: Normal status
004Ah	CRC error	R	1: Error detected, 0: No error (*2)
004Bh	Overrun	R	1: Error detected, 0: No error (*2)
004Ch	Framing error	R	1: Error detected, 0: No error (*2)
004Dh	Parity error	R	1: Error detected, 0: No error (*2)
004Eh	Sum check error	R	1: Error detected, 0: No error (*2)
004Fh	(reserved)		
0050h	WCO (window comparator O)	R	1: ON, 0:FF
0051h	WCO (window comparator O1)	R	1: ON, 0:FF
0052h	WCO (window comparator O2)	R	1: ON, 0:FF

- *1 Normally, this coil is turned on when the corresponding intelligent input terminal on the control circuit terminal block is turned on or the coil itself is set to on. In this regard, the operation of the intelligent input terminal has priority over the operation of the coil. If disconnection of the communication train has disabled the master system from turning off the coil, turn the corresponding intelligent input terminal on the control circuit block on and off. This operation turns off the coil.
- *2 Communication error data is retained until an error reset command is input. (The data can be reset during the inverter operation.)

(ii) List of registers (frequency settings and trip monitoring)

Register No.	Function name	Function code	R/W	Monitoring and setting items	Data resolution
0001h	Frequency source setting	F001 (high)	R/W	0 to 40000 (valid when A001 = 03)	0.01 [Hz]
0002h		F001 (low)	R/W		
0003h	Inverter status A	-	R	0: Initial status, 1: Waiting for Vdc establishment, 2: Stopping, 3: Running, 4: Free-run stop (FRS), 5: Jogging, 6: DC braking, 7: Frequency being input, 8: Retrying operation, 9: Undervoltage (UV),	-
0004h	Inverter status B	-	R	0: Stopping, 1: Running, 2: Tripping	-
0005h	Inverter status C	-	R	0: ---, 1: Stopping, 2: Decelerating, 3: Constant-speed operation, 4: Accelerating, 5: Forward rotation, 6: Reverse rotation, 7: Switching from forward rotation to reverse rotation, 8: Switching from reverse rotation to forward rotation, 9: Starting forward rotation, 10: Starting reverse rotation	-
0006h	PID feedback	-	R/W	0 to 10000	0.01 [%]
0007h to 0010h	(Reserved)	-	R	Inaccessible	-
0011h	Trip Counter	d080	R	0 to 65530	1 [time]
0012h	Trip monitoring 1 (factor)	d081	R	See the list of inverter trip factors below	-
0013h	Trip monitoring 1 (inverter status)			See the list of inverter trip factors below	-
0014h	Trip monitoring 1 (frequency) (high)			0 to 40000	0.01 [Hz]
0015h	Trip monitoring 1 (frequency) (low)				
0016h	Trip monitoring 1 (current)			Output current at tripping	0.1 A
0017h	Trip monitoring 1 (voltage)			DC input voltage at tripping	1 V
0018h	Trip monitoring 1 (running time) (high)			Cumulative running time at tripping	1h
0019h	Trip monitoring 1 (running time) (low)				
001Ah	Trip monitoring 1 (power-on time) (high)			Cumulative power-on time at tripping	1h
001Bh	Trip monitoring 1 (power-on time) (low)				
001Ch	Trip monitoring 2 (factor)	d082	R	See the list of inverter trip factors below	-
001Dh	Trip monitoring 2 (inverter status)			See the list of inverter trip factors below	-
001Eh	Trip monitoring 2 (frequency) (high)			0 to 40000	0.01 [Hz]
001Fh	Trip monitoring 2 (frequency) (low)				
0020h	Trip monitoring 2 (current)			Output current at tripping	0.1 A
0021h	Trip monitoring 2 (voltage)			DC input voltage at tripping	1 V
0022h	Trip monitoring 2 (running time) (high)			Cumulative running time at tripping	1h
0023h	Trip monitoring 2 (running time) (low)				
0024h	Trip monitoring 2 (power-on time) (high)			Cumulative power-on time at tripping	1h
0025h	Trip monitoring 2 (power-on time) (low)				
0026h	Trip monitoring 3 (factor)	d083	R	See the list of inverter trip factors below	-
0027h	Trip monitoring 3 (inverter status)			See the list of inverter trip factors below	-
0028h	Trip monitoring 3 (frequency) (high)			0 to 40000	0.01 [Hz]
0029h	Trip monitoring 3 (frequency) (low)				
002Ah	Trip monitoring 3 (current)			Output current at tripping	0.1 A
002Bh	Trip monitoring 3 (voltage)			DC input voltage at tripping	1 V
002Ch	Trip monitoring 3 (running time) (high)			Cumulative running time at tripping	1h
002Dh	Trip monitoring 3 (running time) (low)				
002Eh	Trip monitoring 3 (power-on time) (high)			Cumulative power-on time at tripping	1h
002Fh	Trip monitoring 3 (power-on time) (low)				
0030h	Trip monitoring 4 (factor)	d084	R	See the list of inverter trip factors below	-
0031h	Trip monitoring 4 (inverter status)			See the list of inverter trip factors below	-
0032h	Trip monitoring 4 (frequency) (high)			0 to 40000	0.01 [Hz]
0033h	Trip monitoring 4 (frequency) (low)				
0034h	Trip monitoring 4 (current)			Output current at tripping	0.1 A
0035h	Trip monitoring 4 (voltage)			DC input voltage at tripping	1 V
0036h	Trip monitoring 4 (running time) (high)			Cumulative running time at tripping	1h
0037h	Trip monitoring 4 (running time) (low)				
0038h	Trip monitoring 4 (power-on time) (high)			Cumulative power-on time at tripping	1h
0039h	Trip monitoring 4 (power-on time) (low)				

Register No.	Function name	Function code	R/W	Monitoring and setting items	Data resolution
003Ah	Trip monitoring 5 (factor)	d085	R	See the list of inverter trip factors below	-
003Bh	Trip monitoring 5 (inverter status)			See the list of inverter trip factors below	-
003Ch	Trip monitoring 5 (frequency) (high)			0 to 40000	0.01 [Hz]
003Dh	Trip monitoring 5 (frequency) (low)			Output current at tripping	0.1 A
003Eh	Trip monitoring 5 (current)			DC input voltage at tripping	1 V
003Fh	Trip monitoring 5 (voltage)			Cumulative running time at tripping	1h
0040h	Trip monitoring 5 (running time) (high)			Cumulative power-on time at tripping	1h
0041h	Trip monitoring 5 (running time) (low)				
0042h	Trip monitoring 5 (power-on time) (high)				
0043h	Trip monitoring 5 (power-on time) (low)				
0044h	Trip monitoring 6 (factor)	d086	R	See the list of inverter trip factors below	-
0045h	Trip monitoring 6 (inverter status)			See the list of inverter trip factors below	-
0046h	Trip monitoring 6 (frequency) (high)			0 to 40000	0.01 [Hz]
0047h	Trip monitoring 6 (frequency) (low)			Output current at tripping	0.1 A
0048h	Trip monitoring 6 (current)			DC input voltage at tripping	1 V
0049h	Trip monitoring 6 (voltage)			Cumulative running time at tripping	1h
004Ah	Trip monitoring 6 (running time) (high)			Cumulative power-on time at tripping	1h
004Bh	Trip monitoring 6 (running time) (low)				
004Ch	Trip monitoring 6 (power-on time) (high)				
004Dh	Trip monitoring 6 (power-on time) (low)				
004Eh	Programming error monitoring	d090	R	Warning code	-
004Fh to 08Fh	Unused	-	-	Inaccessible	-
0900h	Writing to EEPROM	-	W	0000: Motor constant recalculation 0001: Set data storage in EEPROM Other: Motor constant recalculation and set data storage in EEPROM	-
0901h to 1000h	Unused	-	-	Inaccessible	-

Note 1: Assume that the rated current of the inverter is "1000".

Note 2: If a number not less than "1000" (100.0 seconds) is specified, the second value after the decimal point will be ignored.

List of inverter trip factors

Upper part of trip factor code (indicating the factor)		Lower part of trip factor code (indicating the inverter status)	
Name	Code	Name	Code
No trip factor	0	Resetting	0
Overcurrent protection during constant-speed operation	1	Stopping	1
Overcurrent protection during deceleration	2	Decelerating	2
Overcurrent protection during acceleration	3	Constant-speed operation	3
Overcurrent protection during stopping	4	Accelerating	4
Overload protection	5	Operating at zero frequency	5
Braking resistor overload protection	6	Starting	6
Overvoltage protection	7	DC braking	7
EEPROM error	8	Overload restricted	8
Undervoltage protection	9	SON or FOC operation in progress	9
CT error	10		
CPU error	11		
External trip	12		
USP error	13		
Ground-fault protection	14		
Input overvoltage protection	15		
Instantaneous power failure protection	16		
Power-module temperature error (with the fan stopped)	20		
Power-module temperature error	21		
Gate array communication error	23		
Phase loss input protection	24		
Main circuit error	25		
IGBT error	30		
Thermistor error	35		
Braking error (added)	36		
Emergency stop error	37		
Electronic thermal protection at low speeds	38		
Easy sequence error (invalid instruction)	43		
Easy sequence error (invalid nesting count)	44		
Easy sequence execution error 1	45		
Easy sequence user trip 0 to 9	50 to 59		
Option 1 error 0 to 9	60 to 69		
Option 2 error 0 to 9	70 to 79		

(iii) List of registers (monitoring)

Register No.	Function name	Function code	R/W	Monitoring and setting items	Data resolution
1001h	Output frequency monitoring	d001 (high)	R	0 to 40000	0.01 [Hz]
1002h		d001 (low)			
1003h	Output current monitoring	d002	R	0 to 9999	0.1 [A]
1004h	Rotation direction monitoring	d003	R	0: Stopping, 1: Forward rotation, 2: Reverse rotation	0.1 [Hz]
1005h	Process variable (PV), PID feedback monitoring	d004 (high)	R	0 to 9990	0.1
1006h		d004 (low)			
1007h	Intelligent input terminal status	d005	R	2 [^] 0: Terminal 1 to 2 [^] 7: Terminal 8	1 bit
1008h	Intelligent output terminal status	d006	R	2 [^] 0: Terminal 11 to 2 [^] 4: Terminal 15	1 bit
1009h	Scaled output frequency monitoring	d007 (high)	R	0 to 39960	0.01
100Ah		d007 (low)			
100Bh	Actual-frequency monitoring	d008 (high)	R	-40000 to +40000	0.01 [Hz]
100Ch		d008 (low)			
100Dh	Torque command monitoring	d009	R	-200 to +200	1 [%]
100Eh	Torque bias monitoring	d010	R	-200 to +200	1 [%]
100Fh	(Reserved)	-	-	Inaccessible	-
1010h	Torque monitoring	d012	R	-200 to +200	1 [%]
1011h	Output voltage monitoring	d013	R	0 to 6000	0.1 [V]
1012h	Power monitoring	d014	R	0 to 9999	0.1 [kW]
1013h	Cumulative power monitoring	d015 (high)	R	0 to 9999999	0.1
1014h		d015 (low)			
1015h	Cumulative operation RUN time monitoring	d016 (high)	R	0 to 999900	0.1
1016h		d016 (low)			
1017h	Cumulative power-on time monitoring	d017 (high)	R	0 to 999900	1 [h]
1018h		d017 (low)			
1019h	Heat sink temperature monitoring	d018	R	-200 to 2000	0.1 [°C]
101Ah	Motor temperature monitoring	d019	R	-200 to 2000	0.1 [°C]
101Bh	(Reserved)	-	-	Inaccessible	-
101Ch					
101Dh	Life-check monitoring	d022	R	2 [^] 0: Capacitor on main circuit board 2 [^] 1: Low cooling-fan speed	1 bit
101Eh to 1025h	(Reserved)	-	-	Inaccessible	-
1026h	DC voltage monitoring (across P and N)	d102	R	0 to 9999	0.1 [V]
1027h	BRD load factor monitoring	d103	R	0 to 1000	0.1 [%]
1028h	Electronic thermal overload monitoring	d104	R	0 to 1000	0.1 [%]
1029h to 102Dh	(reserved)	-	-	Inaccessible	-
102Eh	User monitor 1	d025(HIGH)	R	-2147483647 to 2147483647	1
102Fh		d025(LOW)	R		
1030h	User monitor 1	d026(HIGH)	R	-2147483647 to 2147483647	1
1031h		d026(LOW)	R		
1032h	User monitor 1	d027(HIGH)	R	-2147483647 to 2147483647	1
1033h		d027(LOW)	R		
1034h	Pulse counter	d028(HIGH)	R/W	0 to 2147483647	1
1035h		d028(LOW)	R/W		
1036h	Position setting monitor	d029(HIGH)	R	-2147483647 to 2147483647	1
1037h		d029(LOW)	R		
1038h	Position feedback monitor	d030(HIGH)	R	-2147483647 to 2147483647	1
1039h		d030(LOW)	R		
103Ah to 1102h	Unused	-	-	Inaccessible	-

(iv) List of registers

Register No.	Function name	Function code	R/W	Monitoring and setting items	Data resolution
1103h	Acceleration (1) time setting	F002 (high)	R/W	1 to 360000	0.01 [sec.]
1104h		F002 (low)			
1105h	Deceleration (1) time setting	F003 (high)	R/W	1 to 360000	0.01 [sec.]
1106h		F003 (low)			
1107h	Keypad Run key routing	F004	R/W	0 (forward rotation), 1 (reverse rotation)	-
1108h to 1200h	Unused	-	-	Inaccessible	-

(v) List of registers (function modes)

Register No.	Function name	Function code	R/W	Monitoring and setting items	Data resolution
1201h	Frequency source setting	A001	R/W	0 (keypad potentiometer), 1 (control circuit terminal block), 2 (digital operator), 3 (RS485), 4 (option 1), 5 (option 2), 6 (pulse train input), 7 (easy sequence), 10 (operation function result)	-
1202h	Run command source setting	A002	R/W	1 (control circuit terminal block), 2 (digital operator), 3 (RS485), 4 (option 1), 5 (option 2)	-
1203h	Base frequency setting	A003	R/W	30 to "maximum frequency"	1 [Hz]
1204h	Maximum frequency setting	A004	R/W	30 to 400	1 [Hz]
1205h	[AT] selection	A005	R/W	0 (switching between O and OI terminals), 1 (switching between O and O2 terminals), 2 (switching between O terminal and keypad potentiometer), 3 (switching between OI terminal and keypad potentiometer), 4 (switching between O2 and keypad potentiometer)	-
1206h	[O2] selection	A006	R/W	0 (single), 1 (auxiliary frequency input via O and OI terminals) (nonreversible), 2 (auxiliary frequency input via O and OI terminals) (reversible), 3 (disabling O2 terminal)	-
1207h to 120Ah	(Reserved)	-	-	Inaccessible	-
120Bh	[O]-[L] input active range start frequency	A011 (high)	R/W	0 to 40000	0.01 [Hz]
120Ch		A011 (low)			
120Dh	[O]-[L] input active range end frequency	A012 (high)	R/W	0 to 40000	0.01 [Hz]
120Eh		A012 (low)			
120Fh	[O]-[L] input active range start voltage	A013	R/W	0 to "[O]-[L] input active range end voltage"	1 [%]
1210h	[O]-[L] input active range end voltage	A014	R/W	"[O]-[L] input active range start voltage" to 100	1 [%]
1211h	[O]-[L] input active range start frequency selection	A015	R/W	0 (external start frequency), 1 (0 Hz)	-
1212h	External frequency filter time const.	A016	R/W	1 to 30 or 31 (500 ms filter ± 0.1 Hz with hysteresis)	1
1213h	Easy sequence function selection	A017	R/W	0 (disabling), 1 (enabling)	-
1214h	(Reserved)	-	R/W	Inaccessible	-
1215h	Multispeed operation selection	A019	R/W	0 (binary), 1 (bit)	-
1216h	Multispeed frequency setting	A020 (high)	R/W	0 or "start frequency" to "maximum frequency"	0.01 [Hz]
1217h		A020 (low)	R/W		
1218h	Multispeed 1 setting	A021 (high)	R/W	0 or "start frequency" to "maximum frequency"	0.01 [Hz]
1219h		A021 (low)	R/W		
121Ah	Multispeed 2 setting	A022 (high)	R/W	0 or "start frequency" to "maximum frequency"	0.01 [Hz]
121Bh		A022 (low)	R/W		
121Ch	Multispeed 3 setting	A023 (high)	R/W	0 or "start frequency" to "maximum frequency"	0.01 [Hz]
121Dh		A023 (low)	R/W		
121Eh	Multispeed 4 setting	A024 (high)	R/W	0 or "start frequency" to "maximum frequency"	0.01 [Hz]
121Fh		A024 (low)	R/W		
1220h	Multispeed 5 setting	A025 (high)	R/W	0 or "start frequency" to "maximum frequency"	0.01 [Hz]
1221h		A025 (low)	R/W		
1222h	Multispeed 6 setting	A026 (high)	R/W	0 or "start frequency" to "maximum frequency"	0.01 [Hz]
1223h		A026 (low)	R/W		
1224h	Multispeed 7 setting	A027 (high)	R/W	0 or "start frequency" to "maximum frequency"	0.01 [Hz]
1225h		A027 (low)	R/W		
1226h	Multispeed 8 setting	A028 (high)	R/W	0 or "start frequency" to "maximum frequency"	0.01 [Hz]
1227h		A028 (low)	R/W		
1228h	Multispeed 9 setting	A029 (high)	R/W	0 or "start frequency" to "maximum frequency"	0.01 [Hz]
1229h		A029 (low)	R/W		
122Ah	Multispeed 10 setting	A030 (high)	R/W	0 or "start frequency" to "maximum frequency"	0.01 [Hz]
122Bh		A030 (low)	R/W		
122Ch	Multispeed 11 setting	A031 (high)	R/W	0 or "start frequency" to "maximum frequency"	0.01 [Hz]
122Dh		A031 (low)	R/W		
122Eh	Multispeed 12 setting	A032 (high)	R/W	0 or "start frequency" to "maximum frequency"	0.01 [Hz]
122Fh		A032 (low)	R/W		
1230h	Multispeed 13 setting	A033 (high)	R/W	0 or "start frequency" to "maximum frequency"	0.01 [Hz]
1231h		A033 (low)	R/W		
1232h	Multispeed 14 setting	A034 (high)	R/W	0 or "start frequency" to "maximum frequency"	0.01 [Hz]
1233h		A034 (low)	R/W		
1234h	Multispeed 15 setting	A035 (high)	R/W	0 or "start frequency" to "maximum frequency"	0.01 [Hz]

Register No.	Function name	Function code	R/W	Monitoring and setting items Data resolution	Data resolution
1236h	(Reserved)	-	-	Inaccessible	-
1237h	(Reserved)	-	-	Inaccessible	-
1238h	Jog frequency setting	A038	R/W	"Start frequency" to 999	0.01 [Hz]
1239h	Jog stop mode	A039	R/W	0 (free-running after jogging stops [disabled during operation]) 1 (deceleration and stop after jogging stops [disabled during operation]) 2 (DC braking after jogging stops [disabled during operation]) 3 (free-running after jogging stops [enabled during operation]) 4 (deceleration and stop after jogging stops [enabled during operation]) 5 (DC braking after jogging stops [enabled during operation])	-
123Ah	(Reserved)	-	-	Inaccessible	-
123Bh	Torque boost method selection	A041	R/W	0 (manual torque boost), 1 (automatic torque boost)	-
123Ch	Manual torque boost value	A042	R/W	0 to 200	0.1 [%]
123Dh	Manual torque boost frequency adjustment	A043	R/W	0 to 500	0.1 [%]
123Eh	V/F characteristic curve selection, 1st motor	A044	R/W	0 (VC), 1 (VP), 2 (free V/f), 3 (sensorless vector control), 4 (0Hz-range sensorless vector), 5 (vector with sensor)	-
123Fh	V/f gain setting	A045	R/W	20 to 100	1 [%]
1240h	Voltage compensation gain setting for automatic torque boost, 1st motor	A046	R/W	0 to 255	1 [%]
1241h	Slippage compensation gain setting for automatic torque boost, 1st motor	A047	R/W	0 to 255	1 [%]
1242h to 1244h	(Reserved)	-	-	Inaccessible	-
1245h	DC braking enable	A051	R/W	0 (disabling), 1 (enabling), 2 (set frequency only)	-
1246h	DC braking frequency setting	A052	R/W	0 to 40000	0.01 [Hz]
1247h	DC braking wait time	A053	R/W	0 to 50	0.1 [sec.]
1248h	DC braking force during deceleration	A054	R/W	0 to 100	1 [%]
1249h	DC braking time for deceleration	A055	R/W	0 to 600	0.1 [sec.]
124Ah	DC braking/edge or level detection for [DB] input	A056	R/W	0 (edge operation), 1 (level operation)	-
124Bh	DC braking force for starting	A057	R/W	0 to 100	1 [%]
124Ch	DC braking time for starting	A058	R/W	0 to 600	0.1 [sec.]
124Dh	DC braking carrier frequency setting	A059	R/W	5 to 150	0.1 [kHz]
124Eh	(Reserved)	-	-	Inaccessible	-
124Fh	Frequency upper limit setting	A061 (high)	R/W	0 or "maximum frequency limit" to "maximum frequency"	0.01 [Hz]
1250h	Frequency lower limit setting	A061 (low)	R/W	0 or "maximum frequency limit" to "maximum frequency"	0.01 [Hz]
1251h		A062 (high)	R/W		
1252h	Jump (center) frequency setting 1	A062 (low)	R/W	0 to 40000	0.01 [Hz]
1253h		A063 (high)	R/W		
1254h	Jump (hysteresis) frequency width setting 1	A063 (low)	R/W	0 to 1000	0.01 [Hz]
1255h		A064	R/W		
1256h	Jump (center) frequency setting 2	A065 (high)	R/W	0 to 40000	0.01 [Hz]
1257h	Jump (hysteresis) frequency width setting 2	A065 (low)	R/W	0 to 1000	0.01 [Hz]
1258h		A066	R/W		
1259h	Jump (center) frequency setting 3	A067 (high)	R/W	0 to 40000	0.01 [Hz]
125Ah	Jump (hysteresis) frequency width setting 3	A067 (low)	R/W	0 to 1000	0.01 [Hz]
125Bh		A068	R/W		
125Ch	Acceleration stop frequency setting	A069 (high)	R/W	0 to 40000	0.01 [Hz]
125Dh	Acceleration stop time frequency setting	A069 (low)	R/W	0 to 600	0.1 [sec.]
125Eh		A070	R/W		

Register No.	Function name	Function code	R/W	Monitoring and setting items Data resolution	Data resolution
125Fh	PID Function Enable	A071	R/W	0 (disabling), 1 (enabling), 2 (enabling inverted-data output)	-
1260h	PID proportional gain	A072	R/W	2 to 50	0.1
1261h	PID integral time constant	A073	R/W	0 to 36000	0.1 [sec.]
1262h	PID derivative gain	A074	R/W	0 to 10000	0.01 [sec.]
1263h	PV scale conversion	A075	R/W	1 to 9999	0.01
1264h	PV source setting	A076	R/W	0 (input via OI), 1 (input via O), 2 (external communication), 3 (pulse train frequency input), 10 (operation result output)	-
1265h	Reverse PID	A077	R/W	00 (disabling), 01 (enabling)	-
1266h	PID output limiter	A078	R/W	0 to 1000	0.1 [sec.]
1267h	PID feed forward selection	A079	R/W	0 (disabled), 1(O input), 2 (OI input), 3 (O2 input)	-
1268h	(Reserved)	-	R/W	Inaccessible	-
1269h	AVR function select	A081	R/W	0 (always on), 1 (always off), 2 (off during deceleration)	-
126Ah	AVR voltage select	A082	R/W	200 V class: 0 (200)/1 (215)/2 (220)/3 (230)/4 (240) 400 V class: 5 (380)/6 (400)/7 (415)/8 (440)/9 (460)/ 10 (480)	-
126Bh	(Reserved)	-	R/W	Inaccessible	-
126Ch	(Reserved)	-	R/W	Inaccessible	-
126Dh	Operation mode selection	A085	R/W	0 (normal operation), 1 (energy-saving operation), 2 (fuzzy operation)	-
126Eh	Energy saving mode tuning	A086	R/W	0 to 1000	0.1 [%]
126Fh to 1273h	(Reserved)	-	-	Inaccessible	-
1274h	Acceleration (2) time setting	A092 (high)	R/W	1 to 360000	0.01 [sec.]
1275h		A092 (low)	R/W		
1276h	Deceleration (2) time setting	A093 (high)	R/W	1 to 360000	0.01 [sec.]
1277h		A093 (low)	R/W		
1278h	Select method to switch to Acc2/Dec2 profile	A094	R/W	0 (switching by 2CH terminal), 1 (switching by setting)	-
1279h	Acc1 to Acc2 frequency transition point	A095 (high)	R/W	0 to 40000	0.01 [Hz]
127Ah		A095 (low)	R/W		
127Bh	Dec1 to Dec2 frequency transition point	A096 (high)	R/W	0 to 40000	0.01 [Hz]
127Ch		A096 (low)	R/W		
127Dh	Acceleration curve selection	A097	R/W	0 (linear), 1 (S curve), 2 (U curve), 3 (inverted-U curve), 4 (EL-S curve)	-
127Eh	Deceleration curve setting	A098	R/W	0 (linear), 1 (S curve), 2 (U curve), 3 (inverted-U curve), 4 (EL-S curve)	-
127Fh	(Reserved)	-	-	Inaccessible	-
1280h	(Reserved)	-	-	Inaccessible	-
1281h	[OI]-[L] input active range start frequency	A101 (high)	R/W	0 to 40000	0.01 [Hz]
1282h		A101 (low)	R/W		
1283h	[OI]-[L] input active range end frequency	A102 (high)	R/W	0 to 40000	0.01 [Hz]
1284h		A102 (low)	R/W		
1285h	[OI]-[L] input active range start current	A103	R/W	0 to "[OI]-[L] input active range end current"	1 [%]
1286h	[OI]-[L] input active range end current	A104	R/W	"[OI]-[L] input active range start current" to 100	1 [%]
1287h	[OI]-[L] input start frequency enable	A105	R/W	0 (external start frequency), 1 (0 Hz)	-
1288h to 128Ch	(Reserved)	-	-	Inaccessible	-
128Dh	[O2]-[L] input active range start frequency	A111 (high)	R/W	-40000 to 40000	0.01 [Hz]
128Eh		A111 (low)	R/W		
128Fh	[O2]-[L] input active range end frequency	A112 (high)	R/W	-40000 to 40000	0.01 [Hz]
1290h		A112 (low)	R/W		
1291h	[O2]-[L] input active range start voltage	A113	R/W	-100 to "[O2]-[L] input active range end voltage"	1 [%]
1292h	[O2]-[L] input active range end voltage	A114	R/W	"[O2]-[L] input active range start voltage" to 100	1 [%]
1293h to 12A4h	(Reserved)	-	-	Inaccessible	-
12A5h	Acceleration curve constants setting	A131	R/W	1 (smallest swelling) to 10 (largest swelling)	-
12A6h	Deceleration curve constants setting	A132	R/W	1 (smallest swelling) to 10 (largest swelling)	-
12A7h to 12AEh	(Reserved)	-	-	Inaccessible	-
12AFh	Operation-target frequency selection 1	A141	R/W	0 (digital operator), 1 (keypad potentiometer), 2 (input via O), 3 (input via OI), 4 (external communication), 5 (option 1), 6 (option 2), 7 (pulse train frequency input)	-

Register No.	Function name	Function code	R/W	Monitoring and setting items Data resolution	Data resolution
12B0h	Operation-target frequency selection 2	A142	R/W	0 (digital operator), 1 (keypad potentiometer), 2 (input via O), 3 (input via OI), 4 (external communication), 5 (option 1), 6 (option 2), 7 (pulse train frequency input)	-
12B1h	Operator selection	A143	R/W	0 (addition: A141 + A142), 1 (subtraction: A141 - A142), 2 (multiplication: A141 x A142)	-
12B2h	(Reserved)	-	-	Inaccessible	-
12B3h	Frequency to be added	A145 (high)	R/W	0 to 40000	0.01 [Hz]
12B4h		A145 (low)	R/W		
12B5h	Sign of the frequency to be added	A146	R/W	00 (frequency command + A145), 01 (frequency command - A145)	-
12B6h to 12B8h	(Reserved)	-	-	Inaccessible	-
12B9h	EL-S-curve acceleration/deceleration ratio 1	A150	R/W	0 to 50	1 [%]
12BAh	EL-S-curve acceleration/deceleration ratio 2	A151	R/W	0 to 50	1 [%]
12BBh	EL-S-curve deceleration/deceleration ratio 1	A152	R/W	0 to 50	1 [%]
12BCh	EL-S-curve deceleration/deceleration ratio 2	A153	R/W	0 to 50	1 [%]
12BDh to 1300h	(Reserved)	-	-	Inaccessible	-

Register No.	Function name	Function code	R/W	Monitoring and setting items Data resolution	Data resolution
1301h	Selection of restart mode	b001	R/W	0 (tripping), 1 (starting with 0 Hz), 2 (starting with matching frequency), 3 (tripping after deceleration and stopping with matching frequency), 4 (restarting with active matching frequency)	-
1302h	Allowable under-voltage power failure time	b002	R/W	3 to 250	0.1 [sec.]
1303h	Retry wait time before motor restart	b003	R/W	3 to 1000	0.1 [sec.]
1304h	Instantaneous power failure/under-voltage trip alarm enable	b004	R/W	0 (disabling), 1 (enabling), 2 (disabling during stopping and decelerating to stop)	-
1305h	Number of restarts on power failure/under-voltage trip events	b005	R/W	0 (16 times), 1 (unlimited)	-
1306h	Input phase loss detection enable	b006	R/W	0 (disabling), 1 (enabling)	-
1307h	Restart frequency threshold	b007 (high)	R/W	0 to 40000	0.01 [Hz]
1308h		b007 (low)	R/W		
1309h	Selection of retry after tripping	b008	R/W	0 (tripping), 1 (starting with 0 Hz), 2 (starting with matching frequency), 3 (tripping after deceleration and stopping with matching frequency), 4 (restarting with active matching frequency)	-
130Ah	Selection of retry count after undervoltage	b009	R/W	0 (16 times), 1 (unlimited)	-
130Bh	Selection of retry count after overvoltage or overcurrent	b010	R/W	1 to 3	1 [time]
130Ch	Retry wait time after tripping	b011	R/W	3 to 1000	0.1 [sec.]
130Dh	Electronic thermal setting (calculated within the inverter from current output)	b012	R/W	200 to 1000	0.1 [%]
130Eh	Electronic thermal characteristic	b013	R/W	0 (reduced-torque characteristic), 1 (constant-torque characteristic), 2 (free setting)	-
130Fh	(Reserved)	-	-	Inaccessible	-
1310h	Free setting, electronic thermal frequency (1)	b015	R/W	0 to 400	1 [Hz]
1311h	Free setting, electronic thermal current (1)	b016	R/W	0 to Rated current	0.1 [A]
1312h	Free setting, electronic thermal frequency (2)	b017	R/W	0 to 400	1 [Hz]
1313h	Free setting, electronic thermal current (2)	b018	R/W	0 to Rated current	0.1 [A]
1314h	Free setting, electronic thermal frequency (3)	b019	R/W	0 to 400	1 [Hz]
1315h	Free setting, electronic thermal current (3)	b020	R/W	0 to Rated current	0.1 [A]
1316h	Overload restriction operation mode	b021	R/W	0 (disabling), 1 (enabling during acceleration and constant-speed operation), 2 (enabling during constant-speed operation), 3 (enabling during acceleration and constant-speed operation [speed increase at regeneration])	-
1317h	Overload restriction setting	b022	R/W	200 to 2000	0.1 [%]
1318h	Deceleration rate at overload restriction	b023	R/W	10 to 3000	0.01 [sec.]
1319h	Overload restriction operation mode (2)	b024	R/W	0 (disabling), 1 (enabling during acceleration and constant-speed operation), 2 (enabling during constant-speed operation), 3 (enabling during acceleration and constant-speed operation [speed increase at regeneration])	-
131Ah	Overload restriction setting (2)	b025	R/W	200 to 2000	0.1 [%]
131Bh	Deceleration rate at overload restriction (2)	b026	R/W	10 to 3000	0.01 [sec.]
131Ch	Overcurrent suppression enable	b027	R/W	0 (disabling), 1 (enabling)	-
131Dh	Active frequency matching scan start frequency	b028	R/W	200 to 2000	0.1 [%]
131Eh	Active frequency matching, scan-time constant	b029	R/W	10 to 3000	0.01 [sec.]
131Fh	Active frequency matching, restart frequency select	b030	R/W	0 (frequency at the last shutoff), 1 (maximum frequency), 2 (set frequency)	-
1320h	Software lock mode selection	b031	R/W	0 (disabling change of data other than "b031" when SFT is on), 1 (disabling change of data other than "b031" and frequency settings when SFT is on), 2 (disabling change of data other than "b031"), 3 (disabling change of data other than "b031" and frequency settings), 10 (enabling data changes during operation)	-
1322h	(Reserved)	-	-	Inaccessible	-
1323h	Run/power-on warning time	b034 (high)	R/W	0 to 65535	1 [10h]
1324h		b034 (low)	R/W		

Register No.	Function name	Function code	R/W	Monitoring and setting items Data resolution	Data resolution
1326h	Reduced voltage start selection	b036	R/W	0 (minimum reduced voltage start time) to 255 (maximum reduced voltage start time)	-
1327h	Function code display restriction	b037	R/W	0 (full display), 1 (function-specific display), 2 (user setting), 3 (data comparison display), 4 (basicdisplay)	-
1328h	Initial-screen selection	b038	R/W	0 (screen displayed when the STR key was pressed last), 1 (d001), 2 (d002), 3 (d003), 4 (d007), 5 (F001)	-
1329h	Automatic user-parameter setting function enable	b039	R/W	0 (disabling), 1 (enabling)	-
132Ah	Torque limit selection	b040	R/W	00 (quadrant-specific setting), 01 (switching by terminal), 02 (analog input), 03 (option 1), 04 (option 2)	-
132Bh	Torque limit (1) (forward-driving in 4-quadrant mode)	b041	R/W	0 to 200/255 (no)	1 [%]
132Ch	Torque limit (2) (reverse-regenerating in 4-quadrant mode)	b042	R/W	0 to 200/255 (no)	1 [%]
132Dh	Torque limit (3) (reverse-driving in 4-quadrant mode)	b043	R/W	0 to 200/255 (no)	1 [%]
132Eh	Torque limit (4) (forward-regenerating in 4-quadrant mode)	b044	R/W	0 to 200/255 (no)	1 [%]
132Fh	Torque limit LADSTOP enable	b045	R/W	0 (disabling), 1 (enabling)	-
1330h	Reverse Run protection enable	b046	R/W	0 (disabling), 1 (enabling)	-
1331h to 1333h	(Reserved)	-	-	Inaccessible	-
1334h	Controller deceleration and stop on power loss	b050	R/W	0 (disabling), 1 (enabling), 2, (nonstop operation at momentary power failure (no restoration)) 3, (nonstop operation at momentary power failure (restoration to be done))	-
1335h	DC bus voltage trigger level during power loss	b051	R/W	0 to 10000	0.1 [V]
1336h	Over-voltage threshold during power loss	b052	R/W	0 to 10000	0.1 [V]
1337h	Deceleration time setting during power loss (target voltage level)	b053 (high)	R/W	0 to 360000	0.01 [sec.]
1338h		b053 (low)	R/W		
1339h	Initial output frequency decrease during power loss	b054	R/W	0 to 1000	0.01 [Hz]
133Ah	Proportional gain setting for nonstop operation at momentary power failure	b055	R/W	0 to 255	0.01
133Bh	Integral time setting for nonstop operation at momentary power failure	b056	R/W	0 to 65535	0.001 [sec]
133Ch to 133Eh	(Reserved)	-	-	Inaccessible	-
133Fh	Maximum-limit level of window comparators O	b060	R/W	0. to 100. (lower limit : b061 + b062 *2) (%)	1 [%]
1340h	Minimum-limit level of window comparators O	b061	R/W	0. to 100. (lower limit : b060 - b062*2) (%)	1 [%]
1341h	Hysteresis width of window comparators O	b062	R/W	0. to 10. (lower limit : b061 - b062 / 2) (%)	1 [%]
1342h	Maximum-limit level of window comparators OI	b063	R/W	0. to 100. (lower limit : b064 + b066 *2) (%)	1 [%]
1343h	Minimum-limit level of window comparators OI	b064	R/W	0. to 100. (lower limit : b063 - b066 *2) (%)	1 [%]
1344h	Hysteresis width of window comparators OI	b065	R/W	0. to 10. (lower limit : b063 - b064 / 2) (%)	1 [%]
1345h	Maximum-limit level of window comparators OI	b066	R/W	-100. to 100. (lower limit : b067 + b068 *2) (%)	1 [%]
1346h	Minimum-limit level of window comparators O/OI/O2	b067	R/W	-100. to 100. (lower limit : b066 - b068 *2) (%)	1 [%]
1347h	Hysteresis width of window comparators O/OI/O2	b068	R/W	0. to 10. (lower limit : b066 - b067 / 2) (%)	1 [%]
1348h	(Reserved)	-	-	Inaccessible	-
1349h	Operation level at O disconnection	b070	R/W	0. to 100. (%) or "no" (ignore)	1 [%]
134Ah	Operation level at OI disconnection	b071	R/W	0. to 100. (%) or "no" (ignore)	1 [%]
134Bh	Operation level at O2 disconnection	b072	R/W	-100. to 100. (%) or "no" (ignore)	1 [%]
134Ch to 1350	(reserved)	-	-	Inaccessible	-
1351h	Cumulative input power data clearance	b060	R/W	Clearance by setting "1"	-
1352h	Cumulative input power display gain setting	b060	R/W	1 to 1000	1

Register No.	Function name	Function code	R/W	Monitoring and setting items Data resolution	Data resolution
--------------	---------------	---------------	-----	----------------------------------------------	-----------------

1354h	(Reserved)	-	-	Inaccessible	-
1355h	Start frequency adjustment	b082	R/W	10 to 999	0.01 [Hz]
1356h	Carrier frequency setting	b083	R/W	5 to 150	0.1 [kHz]
1357h	Initialization mode (parameters or trip history)	b084	R/W	0 (clearing the trip history), 1 (initializing the data), 2 (clearing the trip history and initializing the data)	-
1358h	Country code for initialization	b085	R/W	0 (Japan), 1 (EU), 2 (U.S.A.)	-
1359h	Frequency scaling conversion factor	b086	R/W	1 to 999	0.1
135Ah	STOP key enable	b087	R/W	0 (enabling), 1 (disabling), 2 (disabling only stop)	-
135Bh	Restart mode after FRS	b088	R/W	0 (starting with 0 Hz), 1 (starting with matching frequency), 2 (starting with active matching frequency)	-
135Ch	(Reserved)	-	-	Inaccessible	-
135Dh	Dynamic braking usage ratio	b090	R/W	0 to 1000	0.1 [%]
135Eh	Stop mode selection	b091	R/W	0 (deceleration until stop), 1 (free-run stop)	-
135Fh	Cooling fan control	b092	R/W	0 (always operating the fan), 1 (operating the fan only during inverter operation [including 5 minutes after power-on and power-off])	-
1360h	(Reserved)	-	-	Inaccessible	-
1361h	(Reserved)	-	-	Inaccessible	-
1362h	Dynamic braking control	b095	R/W	0 (disabling), 1 (enabling [disabling while the motor is stopped]), 2 (enabling [enabling also while the motor is stopped])	-
1363h	Dynamic braking activation level	b096	R/W	330 to 380, 660 to 760	1. [V]
1364h	(Reserved)	-	-	Inaccessible	-
1365h	Thermistor for thermal protection control	b098	R/W	0 (disabling the thermistor), 1 (enabling the thermistor with PTC), 2 (enabling the thermistor with NTC)	-
1366h	Thermal protection level setting	b099	R/W	0. to 9999.	1. [Ω]
1367h	Free-setting V/f frequency (1)	b100	R/W	0. to "free-setting V/f frequency (2)"	1 [Hz]
1368h	Free-setting V/f voltage (1)	b101	R/W	0. to 8000	0.1 [V]
1369h	Free-setting V/f frequency (2)	b102	R/W	0. to "free-setting V/f frequency (3)"	1 [Hz]
136Ah	Free-setting V/f voltage (2)	b103	R/W	0. to 8000	0.1 [V]
136Bh	Free-setting V/f frequency (3)	b104	R/W	0. to "free-setting V/f frequency (4)"	1 [Hz]
136Ch	Free-setting V/f voltage (3)	b105	R/W	0. to 8000	0.1 [V]
136Dh	Free-setting V/f frequency (4)	b106	R/W	0. to "free-setting V/f frequency (5)"	1 [Hz]
136Eh	Free-setting V/f voltage (4)	b107	R/W	0. to 8000	0.1 [V]
136Fh	Free-setting V/f frequency (5)	b108	R/W	0. to "free-setting V/f frequency (6)"	1 [Hz]
1370h	Free-setting V/f voltage (5)	b109	R/W	0. to 8000	0.1 [V]
1371h	Free-setting V/f frequency (6)	b110	R/W	0. to "free-setting V/f frequency (7)"	1 [Hz]
1372h	Free-setting V/f voltage (6)	b111	R/W	0. to 8000	0.1 [V]
1373h	Free-setting V/f frequency (7)	b112	R/W	0. to 400.	1 [Hz]
1374h	Free-setting V/f voltage (7)	b113	R/W	0. to 8000	0.1 [V]
1375h to 137Ah	(Reserved)	-	-	Inaccessible	-
137Bh	Brake Control Enable	b120	R/W	0 (disabling), 1 (enabling)	-
137Ch	Brake Wait Time for Release	b121	R/W	0 to 500	0.01 [sec.]
137Dh	Brake Wait Time for Acceleration	b122	R/W	0 to 500	0.01 [sec.]
137Eh	Brake Wait Time for Stopping	b123	R/W	0 to 500	0.01 [sec.]
137Fh	Brake Wait Time for Confirmation	b124	R/W	0 to 500	0.01 [sec.]
1380h	Brake Release Frequency Setting	b125	R/W	0 to 40000	0.01 [Hz]
1381h	Brake Release Current Setting	b126	R/W	0 to 2000	0.1 [%]
1382h	Braking frequency	b127	R/W	0 to 40000	0.01 [Hz]
1383h	(Reserved)	-	-	Inaccessible	-
1384h	(Reserved)	-	-	Inaccessible	-
1385h	Overvoltage suppression enable	b130	R/W	0 (disabling), 1 (enabling), 2 (enabling with acceleration)	-
1386h	Overvoltage suppression level	b131	R/W	200 V class: 330 to 390 (V) 400 V class: 660 to 780 (V)	1 [V]
1387h	Acceleration and deceleration rate at overvoltage suppression	b132	R/W	10 to 3000	0.01 [sec.]
1388h	Overvoltage suppression proportional gain	b133	R/W	0 to 255	0.01
1389h	Overvoltage suppression Integral time	b134	R/W	0 to 65535	0.001 [sec.]
138Ah to 138Fh	(Reserved)	-	-	Inaccessible	-

Register No.	Function name	Function code	R/W	Monitoring and setting items Data resolution	Data resolution
1390h	Output loss detection enable	b141	R/W	0 (enabling), 1 (disabling)	-
1391h	Output loss detection sensibility	b142	R/W	0~100	1.[%]
1392h to 13A6h	(Reserved)	-	-	Inaccessible	-
13A7h	Automatic return to initial display	b164	R/W	0 (enabling), 1 (disabling)	-
13A8h	(Reserved)	-	-	Inaccessible	-
13A9h	Data Read/Write select	b166	R/W	0(R/W enable), 01(R/W disable)	-
13AAh to 1400h	(Reserved)	-	-	Inaccessible	-

Register No.	Function name	Function code	R/W	Monitoring and setting items Data resolution	Data resolution
1401h	Terminal [1] function	C001	R/W	1 (RV: Reverse RUN), 2 (CF1: Multispeed 1 setting), 3 (CF2: Multispeed 2 setting), 4 (CF3: Multispeed 3 setting), 5 (CF4: Multispeed 4 setting), 6 (JG: Jogging), 7 (DB: external DC braking), 8 (SET: Set 2nd motor data), 9 (2CH: 2-stage acceleration/deceleration), 11 (FRS: free-run stop), 12 (EXT: external trip), 13 (USP: unattended start protection), 14: (CS: commercial power source enable), 15 (SFT: software lock), 16 (AT: analog input voltage/current select), 17 (SET3: 3rd motor control), 18 (RS: reset), 20 (STA: starting by 3-wire input), 21 (STP: stopping by 3-wire input), 22 (F/R: forward/reverse switching by 3-wire input), 23 (PID: PID disable), 24 (PIDC: PID reset), 26 (CAS: control gain setting), 27 (UP: remote control UP function), 28 (DWN: remote control DOWN function), 29 (DWN: remote control data clearing), 31 (OPE: forcible operation), 32 (SF1: multispeed bit 1), 33 (SF2: multispeed bit 2), 34 (SF3: multispeed bit 3), 35 (SF4: multispeed bit 4), 36 (SF5: multispeed bit 5), 37 (SF6: multispeed bit 6), 38 (SF7: multispeed bit 7), 39 (OLR: overload restriction selection), 40 (TL: torque limit enable), 41 (TRQ1: torque limit selection bit 1), 42 (TRQ2: torque limit selection bit 2), 43 (PPI: P/PI mode selection), 44 (BOK: braking confirmation), 45 (ORT: orientation), 46 (LAC: LAD cancellation), 47 (PCLR: clearance of position deviation), 48 (STAT: pulse train position command input enable), 50 (ADD: trigger for frequency addition [A145]), 51 (F-TM: forcible-terminal operation), 52 (ATR: permission of torque command input), 53 (KHC: cumulative power clearance), 54 (SON: servo-on), 55 (FOC: forcing), 56 (MI1: general-purpose input 1), 57 (MI2: general-purpose input 2), 58 (MI3: general-purpose input 3), 59 (MI4: general-purpose input 4), 60 (MI5: general-purpose input 5), 61 (MI6: general-purpose input 6), 62 (MI7: general-purpose input 7), 63 (MI8: general-purpose input 8), 65 (AHD: analog command holding), 66 (CP1: multistage position settings selection 1), 67 (CP2: multistage position settings selection 2), 68 (CP3: multistage position settings selection 3), 69 (ORL: Zero-return limit function), 70 (ORG: Zero-return trigger function), 71 (FOT: forward drive stop), 72 (ROT: reverse drive stop), 73 (SPD: speed / position switching), 74 (PCNT: pulse counter), 75 (PCC: pulse counter clear) 255 (no: no assignment)	-
1402h	Terminal [2] function	C002	R/W		-
1403h	Terminal [3] function	C003	R/W		-
1404h	Terminal [4] function	C004	R/W		-
1405h	Terminal [5] function	C005	R/W		-
1406h	Terminal [6] function	C006	R/W		-
1407h	Terminal [7] function	C007	R/W		-
1408h	Terminal [8] function	C008	R/W		-
1409h	(Reserved)	-	-	Inaccessible	-
140Ah	(Reserved)	-	-	Inaccessible	-
140Bh	Terminal [1] active state	C011	R/W	0 (NO), 1 (NC)	-
140Ch	Terminal [2] active state	C012	R/W	0 (NO), 1 (NC)	-
140Dh	Terminal [3] active state	C013	R/W	0 (NO), 1 (NC)	-
140Eh	Terminal [4] active state	C014	R/W	0 (NO), 1 (NC)	-
140Fh	Terminal [5] active state	C015	R/W	0 (NO), 1 (NC)	-
1410h	Terminal [6] active state	C016	R/W	0 (NO), 1 (NC)	-
1411h	Terminal [7] active state	C017	R/W	0 (NO), 1 (NC)	-
1412h	Terminal [8] active state	C018	R/W	0 (NO), 1 (NC)	-
1413h	Terminal [FW] active state	C019	R/W	0 (NO), 1 (NC)	-
1414h	(Reserved)	-	-	Inaccessible	-

Register No.	Function name	Function code	R/W	Monitoring and setting items Data resolution	Data resolution
1415h	Terminal [11] function	C021	R/W	0 (RUN: running), 1 (FA1: constant-speed reached), 2 (FA2: set frequency overreached), 3 (OL: overload notice advance signal (1)), 4 (OD: output deviation for PID control), 5 (AL: alarm signal), 6 (FA3: set frequency reached), 7 (OTQ: over-torque), 8 (IP: instantaneous power failure), 9 (UV: undervoltage), 10 (TRQ: torque limited), 11 (RNT: operation time over), 12 (ONT: plug-in time over), 13 (THM: thermal alarm signal), 19 (BRK: brake release), 20 (BER: braking error), 21 (ZS: 0 Hz detection signal), 22 (DSE: speed deviation maximum), 23 (POK: positioning completed), 24 (FA4: set frequency overreached 2), 25 (FA5: set frequency reached 2), 26 (OL2: overload notice advance signal (2)), 31 (FBV: PID feedback comparison), 32 (NDC: communication line disconnection), 33 (LOG1: logical operation result 1), 34 (LOG2: logical operation result 2), 35 (LOG3: logical operation result 3), 36 (LOG4: logical operation result 4), 37 (LOG5: logical operation result 5), 38 (LOG6: logical operation result 6), 39 (WAC: capacitor life warning), 40 (WAF: cooling-fan speed drop), 41 (FR: starting contact signal), 42 (OHF: heat sink overheat warning), 43 (LOC: low-current indication signal), 44 (M01: general-purpose output 1), 45 (M02: general-purpose output 2), 46 (M03: general-purpose output 3), 47 (M04: general-purpose output 4), 48 (M05: general-purpose output 5), 49 (M06: general-purpose output 6), 50 (IRDY: inverter ready), 51 (FWR: forward rotation), 52 (RVR: reverse rotation), 53 (MJA: major failure) 54 (WCO: window comparator O), 55 (WCO: window comparator O1), 56 (WCO: window comparator O2) (When alarm code output is selected by "C062", functions "ACO" to "AC2" or "ACO" to "AC3" [ACn: alarm code output] are forcibly assigned to intelligent output terminals [11] to [13] or [11] to [14], respectively.)	-
1416h	Terminal [12] function	C022	R/W		-
1417h	Terminal [13] function	C023	R/W		-
1418h	Terminal [14] function	C024	R/W		-
1419h	Terminal [15] function	C025	R/W		-
141Ah	Alarm relay terminal function	C026	R/W		-
141Bh	[FM] signal selection	C027	R/W	0 (output frequency), 1 (output current), 2 (output torque), 3 (digital output frequency), 4 (output voltage), 5 (input power), 6 (electronic thermal overload), 7 (LAD frequency), 8 (digital current monitoring), 9 (motor temperature), 10 (heat sink temperature), 12 (general-purpose output YA0)	-
141Ch	[AM] signal selection	C028	R/W	0 (output frequency), 1 (output current), 2 (output torque), 4 (output voltage), 5 (input power), 6 (electronic thermal overload), 7 (LAD frequency), 9 (motor temperature), 10 (heat sink temperature), 11 (output torque [signed value]), 13 (general-purpose output YA1)	-
141Dh	[AMI] signal selection	C029	R/W	00 (output frequency), 01 (output current), 02 (output torque), 04 (output voltage), 05 (input power), 06 (electronic thermal overload), 07 (LAD frequency), 09 (motor temperature), 10 (heat sink temperature), 14 (general-purpose output YA2)	-
141Eh	Digital current monitor reference value	C030	R/W	200 to 2000	0.1 [%]
141Fh	Terminal [11] active state	C031	R/W	0 (NO), 1 (NC)	-
1420h	Terminal [12] active state	C032	R/W	0 (NO), 1 (NC)	-
1421h	Terminal [13] active state	C033	R/W	0 (NO), 1 (NC)	-
1422h	Terminal [14] active state	C034	R/W	0 (NO), 1 (NC)	-
1423h	Terminal [15] active state	C035	R/W	0 (NO), 1 (NC)	-
1424h	Alarm relay active state	C036	R/W	0 (NO), 1 (NC)	-
1425h	(Reserved)	-	-	Inaccessible	-
1426h	Low-current indication signal output mode selection	C038	R/W	0 (output during acceleration/deceleration and constant-speed operation), 1 (output only during constant-speed operation)	-
1427h	Low-current indication signal detection level	C039	R/W	0 to 2000	0.1 [%]
1428h	Overload signal output mode	C040	R/W	00 (output during acceleration/deceleration and constant-speed operation), 01 (output only during constant-speed operation)	-
1429h	Overload level setting	C041	R/W	0 to 2000	0.1 [%]

Register No.	Function name	Function code	R/W	Monitoring and setting items Data resolution	Data resolution
142Ah	Frequency arrival setting for accel.	C042 (high)	R/W	0 to 40000	0.01 [Hz]
142Bh		C042 (low)	R/W		
142Ch	Frequency arrival setting for decel.	C043 (high)	R/W	0 to 40000	0.01 [Hz]
142Dh		C043 (low)	R/W		
142Eh	PID deviation level setting	C044	R/W	0 to 1000	0.1 [%]
142Fh	Frequency arrival setting for acceleration (2)	C045 (high)	R/W	0 to 40000	0.01 [Hz]
1430h		C045 (low)	R/W		
1431h	Frequency arrival setting for deceleration (2)	C046 (high)	R/W	0 to 40000	0.01 [Hz]
1432h		C046 (low)	R/W		
1433h to 1437h	(Reserved)	-	-	Inaccessible	-
1438h	Maximum PID feedback data	C052	R/W	0 to 1000	0.1 [%]
1439h	Minimum PID feedback data	C053	R/W	0 to 1000	0.1 [%]
143Ah	(Reserved)	-	R/W	-	-
143Bh	Over-torque (forward-driving) level setting	C055	R/W	0 to 200	1 [%]
143Ch	Over-torque (reverse regenerating) level setting	C056	R/W	0 to 200	1 [%]
143Dh	Over-torque (reverse driving) level setting	C057	R/W	0 to 200	1 [%]
143Eh	Over-torque (forward regenerating) level setting	C058	R/W	0 to 200	1 [%]
143Fh	(Reserved)	-	-	Inaccessible	-
1440h	(Reserved)	-	-	Inaccessible	-
1441h	Electronic thermal warning level setting	C061	R/W	0 to 100	1 [%]
1442h	Alarm code output	C062	R/W	0 (disabling alarm output), 1 (3 bits), 2 (4 bits)	-
1443h	Zero speed detection level	C063	R/W	0 to 10000	0.01 [Hz]
1444h	Heat sink overheat warning level	C064	R/W	0 to 200	1 [°C]
1445h to 144Ah	(Reserved)	-	-	Inaccessible	-
144Bh	Communication speed selection	C071	R/W	2 (loopback test), 3 (2,400 bps), 4 (4,800 bps), 5 (9,600 bps), 6 (19,200 bps)	-
144Ch	Node allocation	C072	R/W	1. to 32.	-
144Dh	Communication data length selection	C073	R/W	7 (7 bits), 8 (8 bits)	-
144Eh	Communication parity selection	C074	R/W	00 (no parity), 01 (even parity), 02 (odd parity)	-
144Fh	Communication stop bit selection	C075	R/W	1 (1 bit), 2 (2 bits)	-
1450h	Selection of the operation after communication error	C076	R/W	0 (tripping), 1 (tripping after decelerating and stopping the motor), 2 (ignoring errors), 3 (stopping the motor after free-running), 4 (decelerating and stopping the motor)	-
1451h	Communication timeout limit	C077	R/W	0 to 9999	0.01 [sec.]
1452h	Communication wait time	C078	R/W	0 to 1000	1 [msec.]
1453h	Communication mode selection	C079	R/W	0 (ASCII), 1 (Modbus-RTU)	-
1454h	(Reserved)	-	-	Inaccessible	-
1455h	[O] input span calibration	C081	R/W	0 to 65530	1
1456h	[OI] input span calibration	C082	R/W	0 to 65530	1
1457h	[O2] input span calibration	C083	R/W	0 to 65530	1
1458h	(Reserved)	-	-	Inaccessible	-
1459h	Thermistor input tuning	C085	R/W	0 to 10000	0.1
145Ah to 145Eh	(Reserved)	-	-	Inaccessible	-
145Fh	Debug mode enable	C091	R	0/1	-
1460h to 1468h	(Reserved)	-	-	Inaccessible	-
1469h	Up/Down memory mode selection	C101	R/W	0 (not storing the frequency data), 1 (storing the frequency data)	-
146Ah	Reset mode selection	C102	R/W	0 (resetting the trip when RS is on), 1 (resetting the trip when RS is off), 2 (enabling resetting only upon tripping [resetting when RS is on]), 3(resetting only trip)	-
146Bh	Restart mode after reset	C103	R/W	0 (starting with 0 Hz), 1 (starting with matching frequency), 2 (restarting with active matching frequency)	-
146Ch	(Reserved)	-	-	Inaccessible	-
146Dh	FM gain adjustment	C105	R/W	50 to 200	1 [%]
146Eh	AM gain adjustment	C106	R/W	50 to 200	1 [%]
146Fh	AMI gain adjustment	C107	R/W	50 to 200	1 [%]

Register No.	Function name	Function code	R/W	Monitoring and setting items Data resolution	Data
--------------	---------------	---------------	-----	----------------------------------------------	------

					resolution
1470h	(Reserved)		R/W		-
1471h	AM bias adjustment	C109	R/W	0 to 100	1 [%]
1472h	AMI bias adjustment	C110	R/W	0 to 100	1 [%]
1473h	Overload setting (2)	C111	R/W	0 to 2000	0.1 [%]
1474h to 147Ch	(Reserved)	-	-	Inaccessible	-
147Dh	[O] input zero calibration	C121	R/W	0 to 65530	1
147Eh	[O] input zero calibration	C122	R/W	0 to 65530	1
147Fh	[O2] input zero calibration	C123	R/W	0 to 65530	1
1480h to 1485h	(Reserved)	-	-	Inaccessible	-
1486h	Output 11 on-delay time	C130	R/W	0 to 1000	0.1 [sec.]
1487h	Output 11 off-delay time	C131	R/W	0 to 1000	0.1 [sec.]
1488h	Output 12 on-delay time	C132	R/W	0 to 1000	0.1 [sec.]
1489h	Output 12 off-delay time	C133	R/W	0 to 1000	0.1 [sec.]
148Ah	Output 13 on-delay time	C134	R/W	0 to 1000	0.1 [sec.]
148Bh	Output 13 off-delay time	C135	R/W	0 to 1000	0.1 [sec.]
148Ch	Output 14 on-delay time	C136	R/W	0 to 1000	0.1 [sec.]
148Dh	Output 14 off-delay time	C137	R/W	0 to 1000	0.1 [sec.]
148Eh	Output 15 on-delay time	C138	R/W	0 to 1000	0.1 [sec.]
148Fh	Output 15 off-delay time	C139	R/W	0 to 1000	0.1 [sec.]
1490h	Output RY on-delay time	C140	R/W	0 to 1000	0.1 [sec.]
1491h	Output RY off-delay time	C141	R/W	0 to 1000	0.1 [sec.]
1492h	Logical output signal 1 selection 1	C142	R/W	Same as the settings of C021 to C026 (except those of LOG1 to LOG6)	-
1493h	Logical output signal 1 selection 2	C143	R/W	Same as the settings of C021 to C026 (except those of LOG1 to LOG6)	-
1494h	Logical output signal 1 operator selection	C144	R/W	0 (AND), 1 (OR), 2 (XOR)	-
1495h	Logical output signal 2 selection 1	C145	R/W	Same as the settings of C021 to C026 (except those of LOG1 to LOG6)	-
1496h	Logical output signal 2 selection 2	C146	R/W	Same as the settings of C021 to C026 (except those of LOG1 to LOG6)	-
1497h	Logical output signal 2 operator selection	C147	R/W	0 (AND), 1 (OR), 2 (XOR)	-
1498h	Logical output signal 3 selection 1	C148	R/W	Same as the settings of C021 to C026 (except those of LOG1 to LOG6)	-
1499h	Logical output signal 3 selection 2	C149	R/W	Same as the settings of C021 to C026 (except those of LOG1 to LOG6)	-
149Ah	Logical output signal 3 operator selection	C150	R/W	0 (AND), 1 (OR), 2 (XOR)	-
149Bh	Logical output signal 4 selection 1	C151	R/W	Same as the settings of C021 to C026 (except those of LOG1 to LOG6)	-
149Ch	Logical output signal 4 selection 2	C152	R/W	Same as the settings of C021 to C026 (except those of LOG1 to LOG6)	-
149Dh	Logical output signal 4 operator selection	C153	R/W	0 (AND), 1 (OR), 2 (XOR)	-
149Eh	Logical output signal 5 selection 1	C154	R/W	Same as the settings of C021 to C026 (except those of LOG1 to LOG6)	-
149Fh	Logical output signal 5 selection 2	C155	R/W	Same as the settings of C021 to C026 (except those of LOG1 to LOG6)	-
14A0h	Logical output signal 5 operator selection	C156	R/W	0 (AND), 1 (OR), 2 (XOR)	-
14A1h	Logical output signal 6 selection 1	C157	R/W	Same as the settings of C021 to C026 (except those of LOG1 to LOG6)	-
14A2h	Logical output signal 6 selection 2	C158	R/W	Same as the settings of C021 to C026 (except those of LOG1 to LOG6)	-
14A3h	Logical output signal 6 operator selection	C159	R/W	0 (AND), 1 (OR), 2 (XOR)	-
14A4h	Response time of intelligent input terminal 1	C160	R/W	0 to 200	
14A5h	Response time of intelligent input terminal 2	C161	R/W	0 to 200	
14A6h	Response time of intelligent input terminal 3	C162	R/W	0 to 200	
14A7h	Response time of intelligent input terminal 4	C163	R/W	0 to 200	
14A8h	Response time of intelligent input terminal 5	C164	R/W	0 to 200	
14A9h	Response time of intelligent input terminal 6	C165	R/W	0 to 200	
14AAh	Response time of intelligent input terminal 7	C166	R/W	0 to 200	
14ABh	Response time of intelligent input terminal 8	C167	R/W	0 to 200	
14ACh	Response time of intelligent input terminal FW	C168	R/W	0 to 200	
14ADh	Multistage speed/position determination time	C169	R/W	0 to 200	
14A4h to 1500h	(Reserved)	-	-	Inaccessible	-

Register No.	Function name	Function code	R/W	Monitoring and setting items Data resolution	Data resolution
1501h	Auto-tuning Setting	H001	R/W	0 (disabling auto-tuning), 1 (auto-tuning without rotation), 2 (auto-tuning with rotation)	-
1502h	Motor data selection, 1st motor	H002	R/W	0 (Hitachi standard data), 1 (auto-tuned data), 2 (auto-tuned data [with online auto-tuning function])	-
1503h	Motor capacity, 1st motor	H003	R/W	(*1)	-
1504h	Motor poles setting, 1st motor	H004	R/W	0 (2 poles), 1 (4 poles), 2 (6 poles), 3 (8 poles), 4 (10 poles)	-
1505h	Motor speed constant, 1st motor	H005 (high)	R/W	0 to 80000	0.001
1506h		H005 (low)	R/W		
1507h	Motor stabilization constant, 1st motor	H006	R/W	0 to 255	1
1508h to 1514h	(Reserved)	-	-	Inaccessible	-
1515h	Motor constant R1, 1st motor	H020 (high)	R/W	1 to 65530	0.001 [Ω]
1516h		H020 (low)	R/W		
1517h	Motor constant R2, 1st motor	H021 (high)	R/W	1 to 65530	0.001 [Ω]
1518h		H021 (low)	R/W		
1519h	Motor constant L, 1st motor	H022 (high)	R/W	1 to 65530	0.01 [mH]
151Ah		H022 (low)	R/W		
151Bh	Motor constant lo	H023 (high)	R/W	1 to 65530	0.01 [A]
151Ch		H023 (low)	R/W		
151Dh	Motor constant J	H024 (high)	R/W	1 to 9999000	0.001
151Eh		H024 (low)	R/W		
151Fh to 1523h	(Reserved)	-	-	Inaccessible	-
1524h	Auto constant R1, 1st motor	H030 (high)	R/W	1 to 65530	0.001 [Ω]
1525h		H030 (low)	R/W		
1526h	Auto constant R2, 1st motor	H031 (high)	R/W	1 to 65530	0.001 [Ω]
1527h		H031 (low)	R/W		
1528h	Auto constant L, 1st motor	H032 (high)	R/W	1 to 65530	0.01 [mH]
1529h		H032 (low)	R/W		
152Ah	Auto constant lo, 1st motor	H033 (high)	R/W	1 to 65530	0.01 [A]
152Bh		H033 (low)	R/W		
152Ch	Auto constant J, 1st motor	H034 (high)	R/W	1 to 9999000	0.001
152Dh		H034 (low)	R/W		
152Eh to 153Ch	(Reserved)	-	-	Inaccessible	-
153Dh	PI proportional gain for 1st motor	H050	R/W	0 to 10000	0.1 [%]
153Eh	PI integral gain for 1st motor	H051	R/W	0 to 10000	0.1 [%]
153Fh	P proportional gain setting for 1st motor	H052	R/W	0 to 1000	0.01
1540h to 1546h	(Reserved)	-	-	Inaccessible	-
1547h	Zero LV limit for 1st motor	H060	R/W	0 to 1000	0.1 [%]
1548h	Zero LV starting boost current for 1st motor	H061	R/W	0 to 50	1 [%]
1549h to 1550h	(Reserved)	-	-	Inaccessible	-
1551h	Terminal selection PI proportional gain setting	H070	R/W	0 to 10000	0.1 [%]
1552h	Terminal selection PI integral gain setting	H071	R/W	0 to 10000	0.1 [%]
1553h	Terminal selection P proportional gain setting	H072	R/W	0 to 1000	0.01
1554h	Gain switching time	H073	R/W	0 to 9999	1 [msec.]
1555h to 1600h	(Reserved)	-	-	Inaccessible	-

Register No.	Function name	Function code	R/W	Monitoring and setting items Data resolution	Data resolution
1601h	Operation mode on expansion card 1 error	P001	R/W	0 (tripping), 1 (continuing operation)	-
1602h	Operation mode on expansion card 2 error	P002	R/W	0 (tripping), 1 (continuing operation)	-
1603h to 160Ah	(Reserved)	-	-	Inaccessible	-
160Bh	Encoder pulse-per-revolution (PPR) setting	P011	R/W	128 to 65000	1
160Ch	Control pulse setting	P012	R/W	0 (ASR), 1 (APR)	-
160Dh	Pulse train mode setting	P013	R/W	0 (mode 0), 1 (mode 1), 2 (mode 2)	-
160Eh	Home search stop position setting	P014	R/W	0 to 4095	1
160Fh	Home search speed setting	P015	R/W	"start frequency" to "maximum frequency" (up to 12000)	0.01 [Hz]
1610h	Home search direction setting	P016	R/W	0 (forward), 1 (reverse)	-
1611h	Home search completion range setting	P017	R/W	0 to 10000	1
1612h	Home search completion delay time setting	P018	R/W	0 to 999	0.01 [sec.]
1613h	Electronic gear set position selection	P019	R/W	0 (feedback side), 1 (commanding side)	-
1614h	Electronic gear ratio numerator setting	P020	R/W	1 to 9999	-
1615h	Electronic gear ratio denominator setting	P021	R/W	1 to 9999	-
1616h	Feed-forward gain setting	P022	R/W	0 to 65535	0.01
1617h	Position loop gain setting	P023	R/W	0 to 10000	0.01
1618h	Position bias setting	P024	-	-2048 to 2048	1
1619h	Temperature compensation thermistor enable	P025	R/W	00 (no compensation), 01 (compensation)	-
161Ah	Over-speed error detection level setting	P026	R/W	0 to 1500	0.1 [%]
161Bh	Speed deviation error detection level setting	P027	R/W	0 to 12000	0.01 [Hz]
161Ch	Numerator of the motor gear ratio	P028	R/W	1 to 9999	1
161Dh	Denominator of the motor gear ratio	P029	R/W	1 to 9999	1
161Eh	(Reserved)	-	-	Inaccessible	-
161Fh	Accel/decel time input selection	P031	R/W	0 (digital operator), 1 (option 1), 2 (option 2), 3 (easy sequence)	-
1620h	Positioning command input selection	P032	R/W	0 (digital operator), 1 (option 1), 2 (option 2)	-
1621h	Torque command input selection	P033	R/W	0 (O terminal), 1 (O1 terminal), 2 (O2 terminal), 3 (digital operator)	-
1622h	Torque command setting	P034	R/W	0 to 200	1 [%]
1623h	Polarity selection at the torque command input via O2 terminal	P035	R/W	0 (as indicated by the sign), 1 (depending on the operation direction)	-
1624h	Torque bias mode	P036	R/W	0 (disabling the mode), 1 (digital operator), 2 (input via O2 terminal)	-
1625h	Torque bias value	P037	R/W	-200 to +200	1 [%]
1626h	Torque bias polarity selection	P038	R/W	0 (as indicated by the sign), 1 (depending on the operation direction)	-
1627h	Speed limit for torque-controlled operation (forward rotation)	P039 (high)	R/W	0 to "maximum frequency"	0.01 [Hz]
1628h		P039 (low)	R/W		
1629h	Speed limit for torque-controlled operation (reverse rotation)	P040 (high)	R/W	0 to "maximum frequency"	0.01 [Hz]
162Ah		P040 (low)	R/W		
162Bh	(Reserved)	-	-	Inaccessible	-
162Ch	(Reserved)	-	-	Inaccessible	-
162Dh	(Reserved)	-	-	Inaccessible	-
162Eh	DeviceNet comm watchdog timer	P044	R/W	0 to 9999	0.01 [sec.]
162Fh	Inverter action on DeviceNet comm error	P045	R/W	0 (tripping), 1 (tripping after decelerating and stopping the motor), 2 (ignoring errors), 3 (stopping the motor after free-running), 4 (decelerating and stopping the motor)	-
1630h	DeviceNet polled I/O: Output instance number	P046	R/W	20, 21, 100	-
1631h	DeviceNet polled I/O: Input instance number	P047	R/W	70, 71, 101	-
1632h	Inverter action on DeviceNet idle mode	P048	R/W	0 (tripping), 1 (tripping after decelerating and stopping the motor), 2 (ignoring errors), 3 (stopping the motor after free-running), 4 (decelerating and stopping the motor)	-

Register No.	Function name	Function code	R/W	Monitoring and setting items Data resolution	Data resolution
1633h	Motor poles setting for RPM	P049	R/W	0 (0 pole), 1 (2 poles), 2 (4 poles), 3 (6 poles), 4 (8 poles), 5 (10 poles), 6 (12 poles), 7 (14 poles), 8 (16 poles), 9 (18 poles), 10 (20 poles), 11 (22 poles), 12 (24 poles), 13 (26 poles), 14 (28 poles), 15 (30 poles), 16 (32 poles), 17 (34 poles), 18 (36 poles), 19 (38 poles)	-
1634h to 1638h	(Reserved)	-	-	Inaccessible	-
1639h	Pulse train frequency scale	P055	R/W	10 to 500 (input frequency corresponding to the allowable maximum frequency)	0.1 [kHz]
163Ah	Time constant of pulse train frequency filter	P056	R/W	1 to 200	0.01 [sec.]
163Bh	Pulse train frequency bias	P057	R/W	-100 to +100	1 [%]
163Ch	Pulse train frequency limit	P058	R/W	0 to 100	1 [%]
163Dh	(Reserved)	-	-	Inaccessible	-
163Eh	Multistage position setting 0	P060(HIGH)	R/W		1
163Fh		P060(LOW)	R/W		
1640h	Multistage position setting 1	P061(HIGH)	R/W		1
1641h		P061(LOW)	R/W		
1642h	Multistage position setting 2	P062(HIGH)	R/W		1
1643h		P062(LOW)	R/W		
1644h	Multistage position setting 3	P063(HIGH)	R/W		1
1645h		P063(LOW)	R/W		
1646h	Multistage position setting 4	P064(HIGH)	R/W		1
1647h		P064(LOW)	R/W		
1648h	Multistage position setting 5	P065(HIGH)	R/W		1
1649h		P065(LOW)	R/W		
164Ah	Multistage position setting 6	P066(HIGH)	R/W		1
164Bh		P066(LOW)	R/W		
164Ch	Multistage position setting 7	P067(HIGH)	R/W		1
164Dh		P067(LOW)	R/W		
164Eh	Zero-return mode selection	P068	R/W	0(Low) / 1(High1) / 2(High2)	
164Fh	Zero-return direction selection	P069	R/W	0(FW) / 1(RV)	
1650h	Low-speed zero-return frequency	P070	R/W	0 to 1000	
1651h	High-speed zero-return frequency	P071	R/W	0 to 40000	
1652h	Position range specification (forward)	P072(HIGH)	R/W	0 to 536870912 (when P012 = 2) / 0 to 2147483647 (when P012 = 3)	1
1653h		P072(LOW)	R/W		
1654h	Position range specification (reverse)	P073(HIGH)	R/W	-536870912 to 0 (when P012 = 2) / -2147483647 to 0 (when P012 = 3)	1
1655h		P073(LOW)	R/W		
1656h to 1665h	(Reserved)	-	-	Inaccessible	-
1666h	Easy sequence user parameter U (00)	P100	R/W	0 to 65530	1
1667h	Easy sequence user parameter U (01)	P101	R/W	0 to 65530	1
1668h	Easy sequence user parameter U (02)	P102	R/W	0 to 65530	1
1669h	Easy sequence user parameter U (03)	P103	R/W	0 to 65530	1
166Ah	Easy sequence user parameter U (04)	P104	R/W	0 to 65530	1
166Bh	Easy sequence user parameter U (05)	P105	R/W	0 to 65530	1
166Ch	Easy sequence user parameter U (06)	P106	R/W	0 to 65530	1
166Dh	Easy sequence user parameter U (07)	P107	R/W	0 to 65530	1
166Eh	Easy sequence user parameter U (08)	P108	R/W	0 to 65530	1
166Fh	Easy sequence user parameter U (09)	P109	R/W	0 to 65530	1
1670h	Easy sequence user parameter U (10)	P110	R/W	0 to 65530	1
1671h	Easy sequence user parameter U (11)	P111	R/W	0 to 65530	1
1672h	Easy sequence user parameter U (12)	P112	R/W	0 to 65530	1
1673h	Easy sequence user parameter U (13)	P113	R/W	0 to 65530	1
1674h	Easy sequence user parameter U (14)	P114	R/W	0 to 65530	1
1675h	Easy sequence user parameter U (15)	P115	R/W	0 to 65530	1
1676h	Easy sequence user parameter U (16)	P116	R/W	0 to 65530	1
1677h	Easy sequence user parameter U (17)	P117	R/W	0 to 65530	1
1678h	Easy sequence user parameter U (18)	P118	R/W	0 to 65530	1
1679h	Easy sequence user parameter U (19)	P119	R/W	0 to 65530	1
167Ah	Easy sequence user parameter U (20)	P120	R/W	0 to 65530	1
167Bh	Easy sequence user parameter U (21)	P121	R/W	0 to 65530	1
167Ch	Easy sequence user parameter U (22)	P122	R/W	0 to 65530	1
167Dh	Easy sequence user parameter U (23)	P123	R/W	0 to 65530	1
167Eh	Easy sequence user parameter U (24)	P124	R/W	0 to 65530	1
167Fh	Easy sequence user parameter U (25)	P125	R/W	0 to 65530	1

Register No.	Function name	Function code	R/W	Monitoring and setting items	Data resolution	Data resolution
1681h	Easy sequence user parameter U (27)	P127	R/W	0 to 65530		1
1682h	Easy sequence user parameter U (28)	P128	R/W	0 to 65530		1
1683h	Easy sequence user parameter U (29)	P129	R/W	0 to 65530		1
1684h	Easy sequence user parameter U (30)	P130	R/W	0 to 65530		1
1685h	Easy sequence user parameter U (31)	P131	R/W	0 to 65530		1
1686h to 2102h	(Reserved)	-	-	Inaccessible		-

*1 The following table lists the code data for parameter "H003" (motor capacity selection):

Code data	00	01	02	03	04	05	06	07	08	09	10
Japan or U.S.A. mode (b085 = 00 or 02)	0.2 kW	-	0.4	-	0.75	-	1.5	2.2	-	3.7	-
EU mode (b085 = 01)	0.2 kW	0.37	-	0.55	0.75	1.1	1.5	2.2	3.0	-	4.0
Code data	11	12	13	14	15	16	17	18	19	20	21
Japan or U.S.A. mode (b085 = 00 or 02)	5.5 kW	7.5	11	15	18.5	22	30	37	45	55	75
EU mode (b085 = 01)	5.5 kW	7.5	11	15	18.5	22	30	37	45	55	75
Code data	22	23	24	25	26						
Japan or U.S.A. mode (b085 = 00 or 02)	90kW	110	132	150	160						
EU mode (b085 = 01)	90kW	110	132	150	160						

(vi) List of registers (2nd control settings)

Register No.	Function name	Function code	R/W	Monitoring and setting items Data resolution	Data resolution
2103h	Acceleration (1) time setting, 2nd motor	F202 (high)	R/W	1 to 360000	0.01 [sec.]
2104h		F202 (low)	R/W		
2105h	Deceleration time, 2nd motor	F203 (high)	R/W	1 to 360000	0.01 [sec.]
2106h		F203 (low)	R/W		
2107h to 2202h	(Reserved)	-	-	Inaccessible	-

(vii) List of registers (function modes for the 2nd control settings)

Register No.	Function name	Function code	R/W	Monitoring and setting items Data resolution	Data resolution
2203h	Base frequency setting, 2nd motor	A203	R/W	30 to "maximum frequency, 2nd motor"	1 [Hz]
2204h	Maximum frequency setting, 2nd motor	A204	R/W	30 to 400	1 [Hz]
2205h to 2215h	(Reserved)	-	-	Inaccessible	-
2216h	Multispeed frequency setting, 2nd motor	A220 (high)	R/W	0 or "start frequency" to "maximum frequency, 2nd motor"	0.01 [Hz]
2217h		A220 (low)	R/W		
2218h to 223Ah	(Reserved)	-	-	Inaccessible	-
223Bh	Torque boost method selection, 2nd motor	A241	R/W	0 (manual torque boost), 1 (automatic torque boost)	-
223Ch	Manual torque boost value, 2nd motor	A242	R/W	0 to 200	0.1 [%]
223Dh	Manual torque boost frequency adjustment, 2nd motor	A243	R/W	0 to 500	0.1 [%]
223Eh	V/F characteristic curve selection, 2nd motor	A244	R/W	0 (VC), 1 (VP), 2 (free V/f), 3 (sensorless vector control), 4 (0Hz-range sensorless vector)	-
223Fh	(Reserved)	-	-	Inaccessible	-
2240h	Voltage compensation gain setting for automatic torque boost, 2nd motor	A246	R/W	0 to 255	1
2241h	Slippage compensation gain setting for automatic torque boost, 2nd motor	A247	R/W	0 to 255	1
2242h to 224Eh	(Reserved)	-	-	Inaccessible	-
224Fh	Frequency upper limit setting, 2nd motor	A261 (high)	R/W	00 or "2nd minimum frequency limit" to "maximum frequency, 2nd motor"	0.01 [Hz]
2250h		A261 (low)	R/W		
2251h	Frequency lower limit setting, 2nd motor	A262 (high)	R/W	00 or "start frequency" to "maximum frequency, 2nd motor limit"	0.01 [Hz]
2252h		A262 (low)	R/W		
2253h to 226Eh	(Reserved)	-	-	Inaccessible	-
226Fh	Acceleration (2) time setting, 2nd motor	A292 (high)	R/W	1 to 360000	0.01 [sec.]
2270h		A292 (low)	R/W		
2271h	Deceleration (2) time setting, 2nd motor	A293 (high)	R/W	1 to 360000	0.01 [sec.]
2272h		A293 (low)	R/W		
2273h	Select method to switch to Acc2/Dec2, 2nd motor	A294	R/W	0 (switching by 2CH terminal), 1 (switching by setting), 2 (switching only when the rotation is reversed)	-
2274h	Acc1 to Acc2 frequency transition point, 2nd motor	A295 (high)	R/W	0 to 40000	0.01 [Hz]
2275h		A295 (low)	R/W		
2276h	Dec1 to Dec2 frequency transition point, 2nd motor	A296 (high)	R/W	0 to 40000	0.01 [Hz]
2277h		A296 (low)	R/W		
2278h to 230Bh	(Reserved)	-	-	Inaccessible	-

Register No.	Function name	Function code	R/W	Monitoring and setting items Data resolution	Data resolution
230Ch	Electronic thermal setting (calculated within the inverter from current output), 2nd motor	b212	R/W	200 to 1000	0.1 [%]
230Dh	Electronic thermal characteristic, 2nd motor	b213	R/W	0 (reduced-torque characteristic), 1 (constant-torque characteristic), 2 (free setting)	-
230Eh to 2501h	(Reserved)	-	-	Inaccessible	-
2502h	Motor data selection, 2nd motor	H202	R/W	0 (Hitachi standard data), 1 (auto-tuned data), 2 (auto-tuned data [with online auto-tuning function])	0.1 [%]
2503h	Motor capacity, 2nd motor	H203	R/W	(*1)	-
2504h	Motor poles setting, 2nd motor	H204	R/W	0 (2 poles), 1 (4 poles), 2 (6 poles), 3 (8 poles), 4 (10 poles)	-
2505h	Motor speed constant, 2nd motor	H205 (high)	R/W	1 to 80000	0.001
2506h		H205 (low)	R/W		
2507h	Motor stabilization constant, 2nd motor	H206	R/W	0 to 255	1
2508h to 2514h	(Reserved)	-	-	Inaccessible	-
2515h	Motor constant R1, 2nd motor	H220 (high)	R/W	1 to 65530	0.001 [Ω]
2516h		H220 (low)	R/W		
2517h	Motor constant R2, 2nd motor	H221 (high)	R/W	1 to 65530	0.001 [Ω]
2518h		H221 (low)	R/W		
2519h	Motor constant L, 2nd motor	H222 (high)	R/W	1 to 65530	0.01 [mH]
251Ah		H222 (low)	R/W		
251Bh	Motor constant I _o , 2nd motor	H223 (high)	R/W	1 to 65530	0.01 [A]
251Ch		H223 (low)	R/W		
251Dh	Motor constant J, 2nd motor	H224 (high)	R/W	1 to 9999000	0.001
251Eh		H224 (low)	R/W		
251Fh to 2523h	(Reserved)	-	-	Inaccessible	-
2524h	Auto constant R1, 2nd motor	H230 (high)	R/W	1 to 65530	0.001 [Ω]
2525h		H230 (low)	R/W		
2526h	Auto constant R2, 2nd motor	H231 (high)	R/W	1 to 65530	0.001 [Ω]
2527h		H231 (low)	R/W		
2528h	Auto constant L, 2nd motor	H232 (high)	R/W	1 to 65530	0.01 [mH]
2529h		H232 (low)	R/W		
252Ah	Auto constant I _o , 2nd motor	H233 (high)	R/W	1 to 65530	0.01 [A]
252Bh		H233 (low)	R/W		
252Ch	Auto constant J, 2nd motor	H234 (high)	R/W	1 to 9999000	0.001
252Dh		H234 (low)	R/W		
252Eh to 253Ch	(Reserved)	-	-	Inaccessible	-
253Dh	PI proportional gain for 2nd motor	H250	R/W	0 to 10000	0.1 [%]
253Eh	PI integral gain for 2nd motor	H251	R/W	0 to 10000	0.1 [%]
253Fh	P proportional gain setting for 2nd motor	H252	R/W	0 to 1000	0.01
2540h to 2546h	(Reserved)	-	-	Inaccessible	-
2547h	Zero LV limit for 2nd motor	H260	R/W	0 to 1000	0.1 [%]
2548h	Zero LV starting boost current for 2nd motor	H261	R/W	0 to 50	1 [%]
2549h to 3102h	(Reserved)	-	-	Inaccessible	-

*1 The following table lists the code data for parameter "H203" (motor capacity selection):

Code data	00	01	02	03	04	05	06	07	08	09	10
Japan or U.S.A. mode (b085 = 00 or 02)	0.2 kW	-	0.4	-	0.75	-	1.5	2.2	-	3.7	-
EU mode (b085 = 01)	0.2 kW	0.37	-	0.55	0.75	1.1	1.5	2.2	3.0	-	4.0
Code data	11	12	13	14	15	16	17	18	19	20	21
Japan or U.S.A. mode (b085 = 00 or 02)	5.5 kW	7.5	11	15	18.5	22	30	37	45	55	75
EU mode (b085 = 01)	5.5 kW	7.5	11	15	18.5	22	30	37	45	55	75
Code data	22	23	24	25	26						
Japan or U.S.A. mode (b085 = 00 or 02)	90kW	110	132	150	160						
EU mode (b085 = 01)	90kW	110	132	150	160						

(viii) List of registers (3rd control settings)

Register No.	Function name	Function code	R/W	Monitoring and setting items Data resolution	Data resolution
3103h	Acceleration (1) time setting, 3rd motor	F302 (high)	R/W	1 to 360000	0.01 [sec.]
3104h		F302 (low)	R/W		
3105h	Deceleration (1) time setting, 3rd motor	F303 (high)	R/W	1 to 360000	0.01 [sec.]
3106h		F303 (low)	R/W		
3107h to 3202h	(Reserved)	-	-	Inaccessible	-

(ix) List of registers (3rd control setting)

Register No.	Function name	Function code	R/W	Monitoring and setting items Data resolution	Data resolution
3203h	Base frequency setting, 3rd motor	A303	R/W	30 to "maximum frequency, 3rd motor"	1 [Hz]
3204h	Maximum frequency setting, 3rd motor	A304	R/W	30 to 400	1 [Hz]
3205h to 3215h	(Reserved)	-	-	Inaccessible	-
3216h	Multispeed frequency setting, 3rd motor	A320 (high)	R/W	0 or "start frequency" to "maximum frequency, 3rd motor"	0.01 [Hz]
3217h		A320 (low)	R/W		
3218h to 323Bh	(Reserved)	-	-	Inaccessible	-
323Ch	Manual torque boost value, 3rd motor	A342	R/W	0 to 200	0.1 [%]
323Dh	Manual torque boost frequency adjustment, 3rd motor	A343	R/W	0 to 500	0.1 [%]
323Eh	V/F characteristic curve selection, 3rd motor	A344	R/W	0 (VC), 1(VP)	-
323Fh to 326Ch	(Reserved)	-	-	Inaccessible	-
326Dh	Acceleration (2) time setting, 3rd motor	A392 (high)	R/W	1 to 360000	0.01 [sec.]
326Eh		A392 (low)	R/W		
326Fh	Deceleration (2) time setting, 3rd motor	A393 (high)	R/W	1 to 360000	0.01 [sec.]
3270h		A393 (low)	R/W		
3271h to 330B	(Reserved)	-	-	Inaccessible	-
330Ch	Electronic thermal setting (calculated within the inverter from current output), 3rd motor	b312	R/W	200 to 1000	0.1 [%]
330Dh	Electronic thermal characteristic, 3rd motor	b313	R/W	0 (reduced-torque characteristic), 1 (constant-torque characteristic), 2 (free setting)	-
330Eh to 3506h	(Reserved)	-	-	Inaccessible	-
3507h	Motor stabilization constant, 3rd motor	H306	R/W	0 to 255	1
3508h to	(Reserved)	-	-	Inaccessible	-











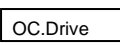

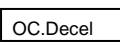

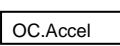
Chapter 5 Error Codes

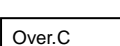
This chapter describes the error codes of the inverter, error indications by the functions, and troubleshooting methods.

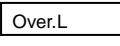
5.1	Error Codes and Troubleshooting.....	5 - 1
5.2	Warning Codes	5 - 10

5.1 Error Codes and Troubleshooting

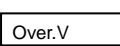









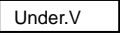

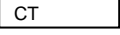

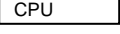



5.1.1 Error Codes

Name	Description		Display on digital operator	Display on remote operator	Troubleshooting and corrective action	Reference page
Overcurrent protection	If the motor is constrained or suddenly accelerated or decelerated, a high current will flow in the inverter and the inverter may fail. To avoid this problem, the inverter shuts off its output and displays the error code shown on the right when it detects a current higher than a specified level. This protective function uses a DC current detector (CT) to detect overcurrent. When a current as high as about 220% of the inverter's rated output current is detected, the protective circuit operates and the inverter trips.	During constant-speed operation			Check whether the load has fluctuated sharply. (Eliminate the load fluctuation.) Check for the short circuit of output connections. (Check the output cables.) Check for the ground fault. (Check the output cables and motor.)	-
		During deceleration			Check whether the inverter has decelerated the motor quickly. (Increase the deceleration time.)	4-10 4-31
		During acceleration			Check whether the inverter has accelerated the motor quickly. (Increase the acceleration time.) Check whether the motor has been locked. (Check the motor and wiring.) Check whether the torque boost current has been set too high. (Reduce the boost current.)	4-10 4-31
		Others			Check whether the DC braking force is too high. (Reduce the braking force.) Check whether the current detector (CT) is normal. (Replace or repair the CT.)	4-21
Overload protection (*1)	This protective function monitors the inverter output current, and shuts off the inverter output and displays the error code shown on the right when the internal electronic thermal protection circuit detects a motor overload. If the error occurs, the inverter will trip according to the setting of the electronic thermal function.				Check whether the motor load is too high. (Reduce the load factor.) Check whether the thermal level is appropriate. (Adjust the level appropriately.) Note: The electronic thermal protection is easily triggered when the output frequency is 5 Hz or less. If the moment of inertia of the load is large, this protective function may operate when the inverter accelerates the motor and the acceleration may be disabled. If this problem occurs, increase the torque boost current or adjust other settings as needed.	4-38
Braking resistor overload protection	When the BRD operation rate exceeds the setting of "b090", this protective function shuts off the inverter output and displays the error code shown on the right.				Check whether the inverter has decreased the motor quickly. (Increase the deceleration time.) Check whether the operation cycle is too short. (Prolong the operation cycle.) Check whether the set BRD operation rate is too low. (Adjust the setting to an appropriate level.) Note: confirm the maximum allowable capacity of the resistor.	4-10 4-44
Overvoltage protection	If the DC voltage across the P and N terminals rises too high, an inverter failure may result. To avoid this problem, this protective function shuts off the inverter output and displays the error code shown on the right when the DC voltage across the P and N terminals exceeds a specified level because of an increase in the energy regenerated by the motor or the input voltage (during operation). The inverter will trip if the DC voltage across the P and N terminals exceeds about 400 VDC (in case of the 200 V class models) or about 800 VDC (in case of the 400 V class models).				Check whether the inverter has decreased the motor quickly. (Increase the deceleration time.) Check for a ground fault. (Check the output cables and motor.) Check whether the motor has been rotated by the action of the load. (Reduce the regenerative energy.)	-
EEPROM error (*2) (*3)	When an internal-EEPROM is caused by external noise or an abnormal temperature rise, the inverter shuts off its output and displays the error code shown on the right. Note: An EEPROM error may result in a CPU error.				Check for the noise sources located near the inverter. (Remove noise sources.) Check whether the cooling efficiency has deteriorated. (Check the heat sink for clogging, and clean it.) (Replace the cooling fan.)	-

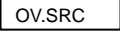

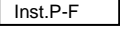



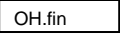



*1 The inverter will not accept any reset command within about 10 seconds after tripping (i.e., after the protective function operates).

*2 The inverter will not accept any reset command after an EEPROM error occurs with error code  displayed. Turn off the inverter power once. If error code "E08" is displayed when the inverter power is turned on subsequently, the internal memory device may have failed or parameters may have not been stored correctly. In such cases, initialize the inverter, and then re-set the parameters.

*3 The inverter will not accept reset commands input via the RS terminal or entered by the STOP/RESET key. Therefore, turn off the inverter power.

Name	Description	Display on digital operator	Display on remote operator	Troubleshooting and corrective action	Reference page
Undervoltage	If the inverter input voltage drops, the control circuit of the inverter cannot function normally. Therefore, the inverter shuts off its output when the input voltage falls below a specified level. The inverter will trip if the DC voltage across the P and N terminals exceeds about 175 VDC (in case of the 200 V class models) or about 345 VDC (in case of the 400 V class models).			Check whether the power supply voltage has dropped. (Check the power supply.) Check whether the power supply capacity is sufficient. (Check the power supply.) Check whether the thyristor has been damaged. (Check the thyristor.)	4-25
CT error	If an error occurs in the internal current detector (CT), the inverter will shut off its output and display the error code shown on the right. The inverter will trip when the CT outputs about 0.6 V or more at power-on.			Check whether the inverter has failed. (Repair the inverter.)	-
CPU error (*3)	If the internal CPU malfunctions or an error occurs in it, the inverter will shut off its output and display the error code shown on the right. Note: Reading an abnormal data from the EEPROM may result in a CPU error.			Check for the noise sources located near the inverter. (Remove noise sources.) Check whether the inverter has failed. (Repair the inverter.)	-
External trip	If an error occurs in the external equipment or device connected to the inverter, the inverter will fetch the error signal and shut off its output. (This protective function is enabled when the external trip function is enabled.)			Check whether an error has occurred in the external equipment (when the external trip function has been enabled). (Recover the external equipment from the error.)	4-56
USP error	A USP error is indicated when the inverter power is turned on with an input operation signal remaining in the inverter. (This protective function is enabled when the USP function is enabled.)			Check whether the inverter power has been turned on with an input operation signal remaining in the inverter (when the USP function has been enabled). (Reset the operation command, and then turn on the inverter power.)	4-55
Ground-fault protection (*3)	When the inverter power is turned on, this protective function detects the ground fault between the inverter output circuit and the motor to protect the inverter. (This function does not operate when a residual voltage remains in the motor.)			Check for the ground fault. (Check the output cables and motor.) Check the inverter itself for abnormality. (Remove the output cables from the inverter, and then check the inverter.) Check the main circuit for abnormality. (Check the main circuit with reference to Chapter 6.) (Repair the inverter.)	-
Input overvoltage protection	This protective function determines an error if the input voltage is kept above the specification level for 100 seconds while the inverter is stopped. The inverter will trip if the DC voltage of the main circuit is kept above about 390 VDC (in case of the 200 V class models) or about 780 VDC (in case of the 400 V class models).			Check whether the input voltage is high while the inverter is stopped. (Lower the input voltage, suppress the power voltage fluctuation, or connect an AC reactor between the power supply and the inverter input.)	-
Instantaneous power failure protection	If an instantaneous power failure lasts 15 ms or more, the inverter will shut off its output. When the power failure duration is long, the inverter assumes a normal power-off. If a restart mode has been selected and an operation command remains in the inverter, the inverter will restart after the power is recovered.			Check whether the power supply voltage has dropped. (Recover the power supply.) Check the MCB and magnetic contactors for poor contacts. (Replace the MCB and the magnetic contactor.)	4-34
Temperature error due to low cooling-fan speed	The inverter will display the error code shown on the right if the lowering of cooling-fan speed is detected at the occurrence of the temperature error described below.			Check whether the cooling efficiency has been lowered. (Replace the cooling fan.) Check the heat sink for clogging. (Clean the heat sink.)	-
Temperature error	If the main circuit temperature rises because of a high ambient temperature or for other reasons, the inverter will shut off its output.			Check whether the inverter is installed vertically. (Check the installation.) Check whether the ambient temperature is high. (Lower the ambient temperature.)	-













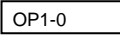
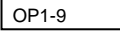

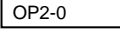
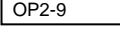

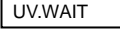

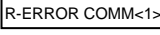
*3 The inverter will not accept reset commands input via the RS terminal or entered by the STOP/RESET key. Therefore, turn off the inverter power.

Name	Description	Display on digital operator	Display on remote operator	Troubleshooting and corrective action	Reference page
Gate array communication error	If an error occurs in the communication between the internal CPU and gate array, the inverter will trip.		GA.COM	Check for the noise sources located near the inverter. (Remove noise sources.) Check whether the communication cable has been disconnected. (Check the connectors.)	-
Phase loss input protection	When the phase loss input protection has been enabled (b006 = 01), the inverter will trip to avoid damage if an phase loss input is detected. The inverter trips when the phase loss input continues for about 1 second or more.		PH.fail	Check for the phase loss power input. (Check the power supply input wiring.) Check the MCB and magnetic contactors for poor contacts. (Replace the MCB and magnetic contactors.)	-
Main circuit error (*3)	The inverter will trip if the gate array cannot confirm the on/off state of IGBT because of a malfunction due to noise, short or damage to the main circuit element.		Main.Cir	Check for the noise sources located near the inverter. (Remove noise sources.) Check the main circuit element for damage. Check the output circuit for a short circuit. (Check the IGBT.) Check the inverter for abnormality. (Repair the inverter.)	-
IGBT error (*5)	If instantaneous overcurrent occurs, the main circuit element temperature is abnormal, or the main circuit element drive power drops, the inverter will shut off its output to protect the main circuit element. (After tripping because of this protective function, the inverter cannot retry the operation.)		IGBT	Check the output circuit for a short circuit. (Check the output cables.) Check for the ground fault. (Check the output cables and motor.) Check the main circuit element for damage. (Check the IGBT.) Check the heat sink for clogging. (Clean the heat sink.)	-
Phase loss output protection	When the phase loss output protection has been enabled (b141 = 01), the inverter will trip to avoid damage if an phase loss output is detected. The inverter can detect an phase loss when the output frequency is from 5 Hz to 100 Hz.		PH.fail	Check for the phase loss output. (Check the output wiring.)	-
Thermistor error	The inverter monitors the resistance of the thermistor (in the motor) connected to the inverter's TH terminal, and will shut off the inverter output if the motor temperature rises.		TH	Check whether the motor temperature is high. (Check the motor temperature.) Check whether the internal thermistor of the motor has been damaged. (Check the thermistor.) Check whether noise has been mixed in the thermistor signal. (Separate the thermistor wiring from other wirings.)	2-8 4-70
Braking error	When "01" has been specified for the Brake Control Enable (b120), the inverter will trip if it cannot receive the braking confirmation signal within the Brake Wait Time for Confirmation (b124) after the output of the brake release signal.		BRAKE	Check whether the brake has been turned on and off or not. (Check the brake.) Check whether the wait time (b124) is too short. (Increase the wait time [b124].) Check whether the braking confirmation signal has been input. (Check the wiring.)	4-79
Emergency stop (*4)	If the EMR signal (on three terminals) is turned on when the slide switch (SW1) on the logic board is set to ON, the inverter hardware will shut off the inverter output and display the error code shown on the right. Malfunction due to incoming noise, in case EMR terminal is not ON.		EMR	Check whether an error has occurred in the external equipment since the emergency stop function was enabled. (Recover the external equipment from the error.) Check for the noise sources located near the inverter. (Remove noise sources.)	2-8
Low-speed overload protection	If overload occurs during the motor operation at a very low speed at 0.2 Hz or less, the electronic thermal protection circuit in the inverter will detect the overload and shut off the inverter output. (2nd electronic thermal control) (Note that a high frequency may be recorded as the error history data.)		OL-LowSP	Check whether the motor load is too high. (Reduce the load factor.)	-
Modbus communication error	If timeout occurs because of line disconnection during the communication in Modbus-RTU mode, the inverter will display the error code shown on the right. (The inverter will trip according to the setting of "C076".)		NET.ERR	Check whether the communication speed setting is correct. Check whether the wiring distance is appropriate. (Check the connections.)	4-106

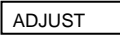
*3 The inverter will not accept reset commands input via the RS terminal or entered by the STOP/RESET key. Therefore, turn off the inverter power.

*4 The inverter will not accept the reset command entered from the digital operator. Therefore, reset the inverter by turning on the RS terminal.

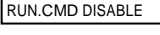
*5 The inverter applied for 004 to 110L/H will not accept reset commands input via the RS terminal or entered by the STOP/RESET key. Therefore, turn off the inverter power.

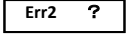
Name	Description	Display on digital operator	Display on remote operator	Troubleshooting and corrective action	Reference page
Option 1 error	The inverter detects errors in the option board mounted in the optional slot 1. For details, refer to the instruction manual for the mounted option board.	 to 	 	Check whether the option board is mounted correctly. (Check the board mounting.) Check whether the option board is used correctly. (Check the instruction manual for the option board.)	Refer to the instruction manual for the SJ-FB, SJ-DG, or SJ-DN.
Option 2 error	The inverter detects errors in the option board mounted in the optional slot 2. For details, refer to the instruction manual for the mounted option board.	 to 	 	Check whether the option board is mounted correctly. (Check the board mounting.) Check whether the option board is used correctly. (Check the instruction manual for the option board.)	Refer to the instruction manual for the SJ-FB, SJ-DG, or SJ-DN.
Waiting in undervoltage status	If the input voltage falls, the inverter will shut off its output, display the code shown on the right, and wait for the recovery of the input voltage. The inverter will display the same error code also during an instantaneous power failure. (remark) Inverter trips with under voltage when this status continues for 40 seconds.			Check whether the power supply voltage has fallen. (Recover the power supply.) Check the MCB and magnetic contactors for poor contacts. (Replace the MCB and magnetic contactors.) Check whether the voltage across the P and N terminals is normal. (Check the voltage across the P and N terminals.)	-
Communication error	If a problem occurs in the communication between the digital operator and inverter, the inverter will display the code shown on the right.		 	Check whether the relay plug is fitted correctly. (Check the relay plug for connection.) Check whether the digital operator is connected correctly. (Check the digital operator for connection.)	-
Waiting for retry	When the retry after instantaneous power failure or tripping has been enabled, the inverter displays the code shown on the right while awaiting retry after an instantaneous power failure or tripping.		 		-
Power-off	The inverter displays the code shown on the right when the inverter power is turned off.				-
Restricted operation command	When an operation direction has been restricted by the setting of "b035", the inverter will display the error code shown on the right if the operation command specifying the restricted operation direction is input.				-
Empty trip history	If the inverter has not tripped before, the inverter displays  .		Ex. Err2 		

5.1.2 Option boards error codes

When an option board is mounted in the optional port 1 (located near the operator connector), the error code display format is "E6*." (on the digital operator) or "OP1-*" (on the remote operator). When it is mounted in the optional port 2 (located near the control circuit terminal block), the error code display format is "E7*." (on the digital operator) or "OP2-*" (on the remote operator).

1) Error indications by protective functions with the feedback option board (SJ-FB) mounted

Name	Description	Display on digital operator	Display on remote operator ERR1***
Encoder disconnection	If the encoder wiring is disconnected, an encoder connection error is detected, the encoder fails, or an encoder that does not support line driver output is used, the inverter will shut off its output and display the error code shown on the right.	E60. E70.	OP1-0 OP2-0
Excessive speed	If the motor speed rises to "maximum frequency (A004) x over-speed error detection level (P026)" or more, the inverter will shut off its output and display the error code shown on the right.	E61. E71.	OP1-1 OP2-1
Positioning error	If, in position control mode, the deviation of the current position from that specified by the positioning command increases to 1,000,000 pulses or more, the inverter will shut off its output and display the error code shown on the right.	E62. E72.	OP1-2 OP2-2
Position control range trip	In absolute position control mode, the inverter shuts off its output and indicates an error when the range specified by the position range specification (forward) (P072) or position range specification (reverse) (P073) is exceeded.	E63. E73.	OP1-3 OP2-3
SJ-FB connection error	If a faulty connection (i.e., mounting) of the feedback option board is detected, the inverter will shut off its output and display the error code shown on the right.	E69. E79.	OP1-9 OP2-9





Note: If the option board does not operate normally, confirm the DIP switch settings on the option board.

Functions of the DIP switches on the feedback option board (SJ-FB)

DIP switch	Switch No.	Setting	
SWENC	1	ON	Enabling the detection of encoder disconnection when the encoder phases A and B are not connected
		OFF	Disabling the detection of encoder disconnection when the encoder phases A and B are not connected
	2	ON	Enabling the detection of encoder disconnection when the encoder phase Z is not connected
		OFF	Disabling the detection of encoder disconnection when the encoder phase Z is not connected
SWR	1	ON	Enabling the terminating resistor between the SAP and SAN terminals (150Ω)
		OFF	Disabling the terminating resistor between the SAP and SAN terminals
	2	ON	Enabling the terminating resistor between the SBP and SBN terminals (150Ω)
		OFF	Disabling the terminating resistor between the SBP and SBN terminals

Note: For details, refer to the instruction manual for the option board.

2) Error indications by protective functions with the digital option board (SJ-DG) mounted

Name	Description	Display on digital operator	Display on remote operator ERR1***
SJ-DG error	If timeout occurs during the communication between the inverter and digital option board, the inverter will shut off its output and display the error code shown on the right.	 	 

Note: The input mode is determined by a combination of DI switch and rotary switch settings. If the option board does not operate normally, confirm the DIP switch and rotary switch settings on the option board.









Functions of the DIP and rotary switches on the digital option board (SJ-DG)

DIP switch		Rotary switch	Frequency setting				Acceleration/ deceleration time setting			Torque limit setting	Position setting	
Type		Code	Data resolution									
Switch No.		Code for setting	0.01 Hz	0.1 Hz	1 Hz	Rate	0.01 sec	0.1 sec	1 sec	1%	1 pulse	
1	2											
OFF: BIN (binary input)/ ON: BCD (BCD input)	OFF: PAC (batch input mode)	0	○									
		1		○								
		2			○							
		3				○						
		4					○				○	
		5										
	6										○	
	ON: DIV (divided-inp ut mode)	0		○				○				
		1	○						○			
		2								○		
		3						○				
		4		○					○			
		5								○		
		6						○				
7					○			○				
8									○			
9							○					
A								○				
B									○			

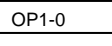
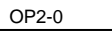
○: Input mode specified by switch settings

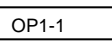
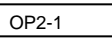
Note: For details, refer to the instruction manual for the option board.

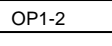
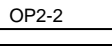

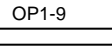
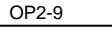
3) Error indications by protective functions with the DeviceNet option board (SJ-DN) mounted

Name	Description	Display on digital operator	Display on remote operator	Troubleshooting and corrective action	Reference page
DeviceNet communication error	If the disconnection due to the Bus-Off signal or timeout occurs during the operation using DeviceNet commands, the inverter will shut off its output and display the error code shown on the right. (The inverter will trip according to the settings of "p45" and "P048".)	 	 	Check whether the communication speed setting is correct. Check whether the wiring distance is appropriate. Check the connections.	Refer to the instruction manual for the SJ-DN.
Duplicate MAC ID	If two or more devices having the same MAC ID are detected in the same network, the inverter will display the error code shown on the right.	 	 	Check whether duplicate MAC IDs are used.	
External trip	If the Force Fault/Trip bit of Attribute 17 in the Instance 1 of the Control Supervisory object is set to "1", the inverter will shut off its output and display the error code shown on the right.	 	 	Check whether the Attribute 17 in the Instance 1 of Class 29 is "1". (If so, clear the bit to "0".)	
Inverter communication error	If timeout occurs during the communication between the inverter and DeviceNet option board, the inverter will shut off its output and display the error code shown on the right.	 	 	Check whether the option board has been disconnected from the inverter.	

Note: If the option board does not operate normally, confirm the DIP switch settings on the option board.

Functions of the DIP switches on the DeviceNet option board (SJ-DN)

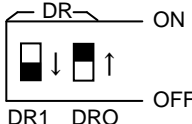
Setting of DeviceNet baud rate (DIP switches No. 1 and No. 2)

Baud rate	125 kbps	250 kbps	500 kbps
DIP switch setting			

Setting of MAC ID (DIP switches No. 3 to No. 8)

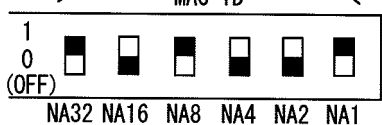
MAC ID	Dip switch setting
	The left-most switch indicates the highest-order bit of MAC ID. Therefore, the example of switch settings shown on the left indicates the following MAC ID: $1 \cdot 2^5 + 0 \cdot 2^4 + 1 \cdot 2^3 + 0 \cdot 2^2 + 0 \cdot 2^1 + 1 \cdot 2^0 = 29$ (hexadecimal) = 41 (decimal)

Note: For details, refer to the instruction manual for the option board.

4) Error indications by protective functions with the easy sequence function used

Name	Description	Display on digital operator	Display on remote operator ERR1***
Invalid instruction	<ul style="list-style-type: none"> - The inverter will display the error code shown on the right if an invalid instruction is found in a downloaded program. (*1) - The inverter will display the error code if the PRG terminal is turned on when no program has been loaded. 	E43	PRG.CMD
Nesting count error	The inverter will display the error code shown on the right if subroutines, "for" instructions, and "next" instructions are nested in more than eight levels.	E44	PRG.NST
Execution error 1	<ul style="list-style-type: none"> - The inverter will display the error code shown on the right if the "for" or another instruction to start nesting is not found at the jump destination of a "go to" instruction, and the "next" or another instruction to end nesting precedes the nesting-start instruction. - An error is assumed when an arithmetic operation instruction has resulted in overflow or underflow or a division by zero has been attempted. - An error is assumed when a "chg param" or "mon param" instruction has attempted to reference an undefined parameter, set the data beyond the specified setting range in a parameter, or update a parameter that cannot be changed during the inverter operation. 	E45	PRG.ERR1
User trips 0 to 9	The inverter outputs an error code when a trip instruction is executed.	E50 S E59	PRG-0 PRG-9

*1 The error code is output when the relevant program runs.

5.1.3 Trip conditions monitoring

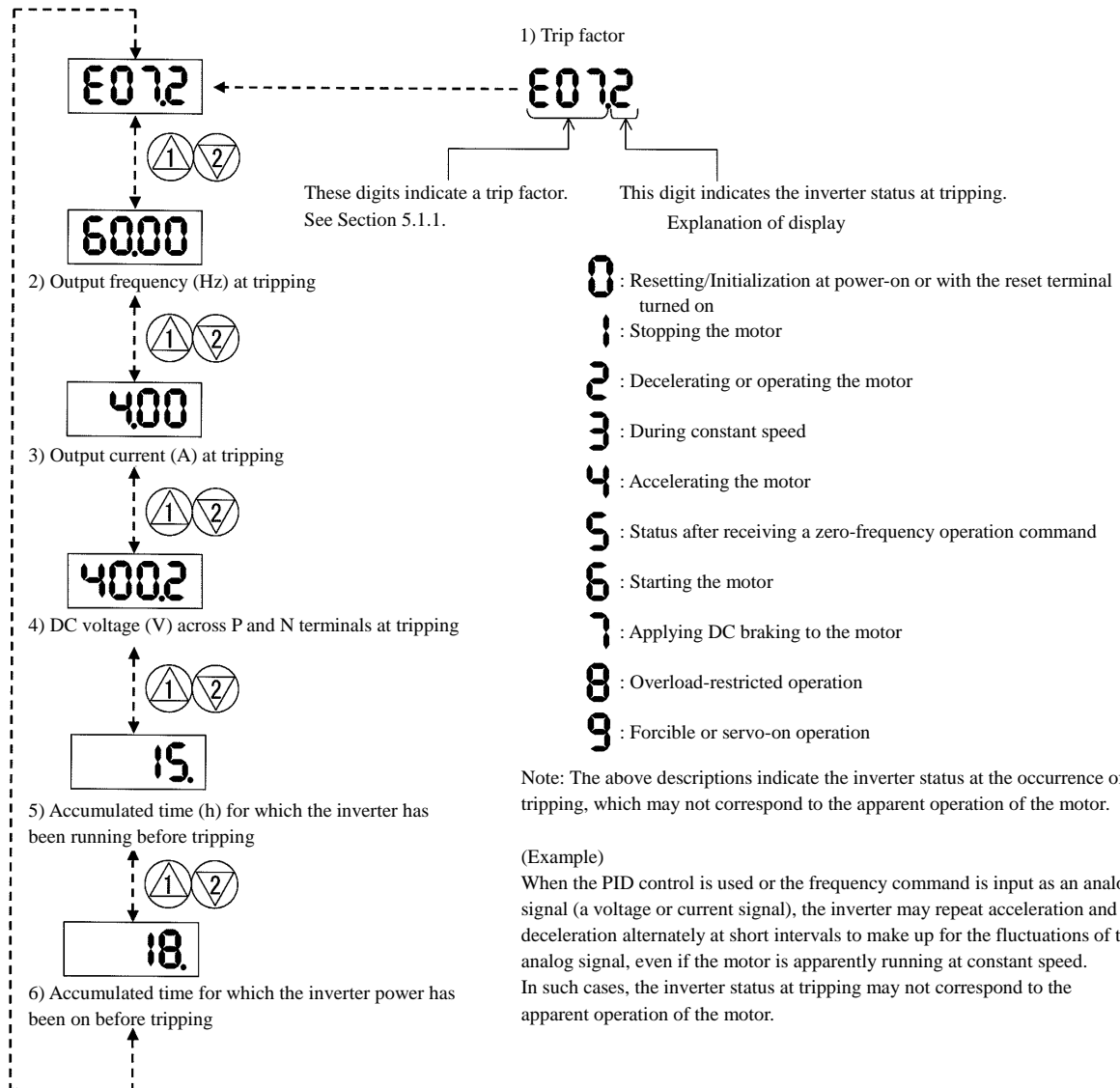

5.2 Warning Codes

The following table lists the warning codes and the contents of parameter readjustments:

Warning code	Target function code	Condition	Basic function code
001/201	Frequency upper limit setting (A061/A261)	>	Maximum frequency setting (A004/A204/A304)
002/202	Frequency lower limit setting (A062/A262)	>	
005/205/305	Output frequency setting (F001) (*)	>	Frequency upper limit setting (A061/A261)
015/215	Output frequency setting (F001) (*)	>	
019	Home search speed setting (P015)	>	Frequency lower limit setting (A062/A262)
025/225	Output frequency setting (F001) (*)	<	
029	Home search speed setting (P015)	<	Start frequency adjustment (b082)
031/231	Frequency upper limit setting (A061/A261)	<	
032/232	Frequency lower limit setting (A062/A262)	<	
035/235/335	Output frequency setting (F001) (*)	<	
037	Jog frequency setting (A038)	<	Jump (center) frequency settings 1/2/3 ± " Jump (hysteresis) frequency width settings 1/2/3"
085/285/385	Output frequency setting (F001) (*)	<>	
086	Multispeed 1 to 15 settings (A021 to A035)	<>	A063 ± A064, A065 ± A066, A067 ± A068
091/291	Frequency upper limit setting (A061/A261)	>	Free-setting V/f frequency (7) (b112)
092/292	Frequency lower limit setting (A062/A262)	>	
095/295	Output frequency setting (F001) (*)	>	

- The inverter displays a warning code when the data set as a target function code satisfies the condition (specified in the Condition column) in relation to the data set as the corresponding basic function code.
- When the inverter is warning, it can not run to work the motor. Refer to the above column and modify the parameters to the correct data.
- When the inverter is warning, you can confirm the warning information 'd090'.
- * These parameters are checked, even when the digital operator (02) is not specified for the frequency source setting (A001).

(Memo)

Chapter 6 Maintenance and Inspection

This chapter describes the precautions and procedures for the maintenance and inspection of the inverter.

6.1	Precautions for Maintenance and Inspection	6-1
6.2	Daily and Periodic Inspections	6-2
6.3	Ground Resistance Test with a Megger	6-3
6.4	Withstand Voltage Test	6-3
6.5	Method of Checking the Inverter and Converter Circuits	6-4
6.6	DC-Bus Capacitor Life Curve.....	6-5
6.7	Output of Life Warning.....	6-5
6.8	Methods of Measuring the Input/Output Voltages, Current, and Power.....	6-6

6.1 Precautions for Maintenance and Inspection



WARNING

- Before inspecting the inverter, be sure to turn off the power supply and wait for 10 minutes or more. Otherwise, you run the risk of electric shock.
(Before inspection, confirm that the Charge lamp on the inverter is off and the DC voltage between terminals P and N is 45 V or less.)
- Commit only a designated person to maintenance, inspection, and the replacement of parts.
(Be sure to remove wristwatches and metal accessories, e.g., bracelets, before maintenance and inspection work and to use insulated tools for the work.)
Otherwise, you run the risk of electric shock and injury.
- Never modify the inverter. Otherwise, you run the risk of electric shock and injury.

6.1.1 Daily inspection

Basically check your system during the inverter operation to confirm that:

- 1) the motor is operating according to the settings on the inverter,
- 2) the installation environment is normal,
- 3) the cooling system is normal,
- 4) no abnormal vibrations and noise are generated,
- 5) no equipment overheating and discoloration are found, and
- 6) there are no unusual smells.

While the inverter is operating, measure the inverter input power voltage with a multimeter to confirm that:

- 1) the power supply voltage does not fluctuate often, and
- 2) the voltages between the power supply wires are balanced.

6.1.2 Cleaning

Always keep the inverter clean. When cleaning the inverter, wipe off dirt and stains on the inverter surface lightly with a soft cloth dipped in a neutral detergent solution.

Note:

Do not use solvents such as acetone, benzene, toluene, and alcohol for cleaning. These solvents cause the inverter surface to dissolve or the coating on the surface to peel off. In particular, never use a detergent or alcohol to clean the monitor of the digital operator.

6.1.3 Periodic inspection

Check those inverter sections and parts which are accessible only while the inverter is stopped and which should be inspected regularly. When you intend to carry out a periodic inspection, contact your local Hitachi Distributor.

During a periodic inspection, perform the following:

- 1) Check that the cooling system is normal. Clean the air filter as needed.
- 2) Check the screws and bolts for tightness, and retighten them. Screws and bolts may have loosened because of vibrations and temperature changes. Check them carefully.
- 3) Check to ensure conductors and insulators are not corroded or damaged.
- 4) Measure the dielectric breakdown voltage of insulators.
- 5) Check the cooling fan, smoothing capacitors, and relays, and replace them if necessary.

Chapter 6 Maintenance and Inspection

6.2 Daily and Periodic Inspections

Part to inspect	Inspection item	Detail of inspection	Inspection cycle			Inspection method	Criterion	Test equipment
			Daily	Periodic				
				Annual	Biennial			
General	Environment	Check the ambient temperature, humidity, and dust.	○			See Section 2.1, "Installation."	The ambient temperature must be within -10°C to +50°C without congelation. The ambient humidity must be 90% RH or less without condensation.	Thermometer, hygrometer, recorder
	Whole inverter	Check for abnormal vibrations and noise.	○			Check visually and by listening.	There must be no abnormality found.	
	Power supply voltage	Check that the main circuit voltage is normal.	○			Measure the voltage between the main circuit terminals R, S, and T.	The measured voltage must be within the allowable tolerance for AC power voltage.	Tester, digital multimeter
Main circuit	General check	(1) Check the ground resistance between the main circuit and ground terminals with a megger.		○		Disconnect all input and output cables from the inverter's main circuit terminal block, detach the control circuit terminal block from the inverter, and remove the jumper for switching the inverter's internal filter function. Subsequently, measure the insulation resistance between the ground terminal and the jumper connecting all the following terminals: R, S, T, U, V, W, P, PD, N, RB, RO, and TO	The measured ground resistance must be 5M Ω or more.	500 VDC class megger
		(2) Check screws and bolts for loosening.	○			Retighten loose screws and bolts.	There must be no abnormality found.	
		(3) Check each part for any trace of overheating.	○			Check visually.	There must be no abnormality found.	
	Connecting conductors and cables	(1) Check the conductors for distortion.	○			Check visually	There must be no abnormality found.	
		(2) Check the cable insulations for damage.	○					
	Terminal block	Check the terminal blocks for damage.	○			Check visually	There must be no abnormality found.	
	Inverter circuit and converter circuit (including resistors)	Check the resistance between terminals.		○		Remove all cables from the inverter's main circuit terminal block. Use a tester (in 1 Ω range mode) to measure the following: - Resistance between terminals R, S, and T and terminals P and N - Resistance between terminals U, V, and W and terminals P and N	See Section 6.5, "Method of Checking the Inverter and Converter Circuits." Standard operating life of power module (IGBT, IPM, Diode and Thyristor) until replacement: 10 ⁶ cycles of starting and stopping (*3)	Analog tester
	Smoothing capacitor	(1) Check for liquid leak.	○			Check visually.	There must be no abnormality found. Target operating life until replacement: 10 years (*1) (*3)	Capacitance meter
		(2) Check that the relief valve does not protrude or swell.	○					
	Relay	(1) Check that no fluttering sound is generated during the relay operation.		○		Check by listening.	There must be no abnormality found.	
(2) Check the contacts for damage.			○		Check visually.	There must be no abnormality found.		
Control and protective circuits	Operation	(1) While performing a unit operation of the inverter, check the balance output voltage among the individual phases.		○		Measure the voltage between the cables connected to the main circuit terminals U, V, and W.	The inter-phase voltage balance must be as follows: 200 V class models: 4 V or less 400 V class models: 8 V or less	Digital multimeter, rectifier instrument, and voltmeter
		(2) Carry out a sequential protection operation test, and check the protective and display circuits for any abnormality.		○		Short-circuit or open the protective circuit outputs as a simulation.	An error must be detected according to the sequence.	
Cooling system	Cooling fan	(1) Check for abnormal vibrations and noise	○			Turn the fan manually during the inverter power-off status.	The fan must rotate smoothly. There must be no abnormality found.	Standard operating life until replacement: 10 years (*2) (*3)
		(2) Check the joints for loosening.		○		Check visually.		
	Heat sink	Check for clogging.		○		Check visually.	The heat sink must not be clogged.	
Display	Monitor	(1) Check that all LEDs light up normally.	○			Check visually.	The LEDs must light up normally.	
		(2) Clean the monitor.		○		Clean the monitor with a rag.		
	Meter	Check that meter readings are normal.	○			Check the meter readings on the panel.	The readings must meet the standard and control values.	Voltmeter and ammeter
Motor	General	(1) Check for abnormal vibrations and noise.	○			Check vibrations and noise visually, by listening, and with physical senses.	There must be no abnormality found.	
		(2) Check for unusual smells.	○			Check for any unusual smells caused by overheating or damage.	There must be no abnormality found.	
	Insulation resistance	Check the ground resistance between all motor terminals and the ground terminal with a megger.		○		Remove the cables from the inverter's main circuit terminals U, V, and W, connect the motor wires (for three phases) with one another, and measure the ground resistance between the motor wires and the ground terminal.	The measured ground resistance must be 5M Ω or more.	500 VDC class megger

*1 The operating life of the smoothing capacitor is under the influence of the ambient temperature. Refer to Section 6.6, "Smoothing-Capacitor Life Curve," as a standard for the operating life until replacement.

*2 The operating life of the cooling fan varies depending on environmental conditions, including the ambient temperature and dust. Check the status of the cooling-fan operation during daily inspections.

*3 The standard operating life (number of years or operation cycles) and the data described in Section 6.6, "Smoothing-Capacitor Life Curve," are based on the expected design life, but they do not indicate the guaranteed life of any parts.

*4 When replacing to the capacitor stored for 3 years or longer, please have shakedown period as below.
Apply 80% of rated voltage for 1 hour.
Increase the voltage to 90% and keep for 1 hour.
Then apply rated voltage for 5 hours.

*5 In case fan is locked by dust or particle, it takes 5 to 10 seconds to restart even after the dust is removed.

6.3 Ground Resistance Test with a Megger

When testing an external circuit with a megger, disconnect all the external circuit cables from the inverter to prevent it from being exposed to the test voltage.

Use a tester (in high-resistance range mode) for a conduction test on the control circuit. Do not use a megger or buzzer for that purpose.

Apply the ground resistance test using a megger only to the main circuit of the inverter. Do not carry out the test using a megger for its control circuit.

Use a 500 VDC megger for the ground resistance test.

Before the main circuit test with a megger, remove the jumper for switching the inverter's internal filter function, and then connect terminals R, S, T, U, V, W, P, PD, N, RB, R0, and T0 by wires as shown in the figure below. Subsequently, carry out the test.

After the test using the megger, remove the wires from terminals R, S, T, U, V, W, P, PD, N, RB, R0, and T0, and connect the jumper for switching the inverter's internal filter function at the original position.

Note that only inverter models with a capacity of less than 22 kW have the RB terminal.

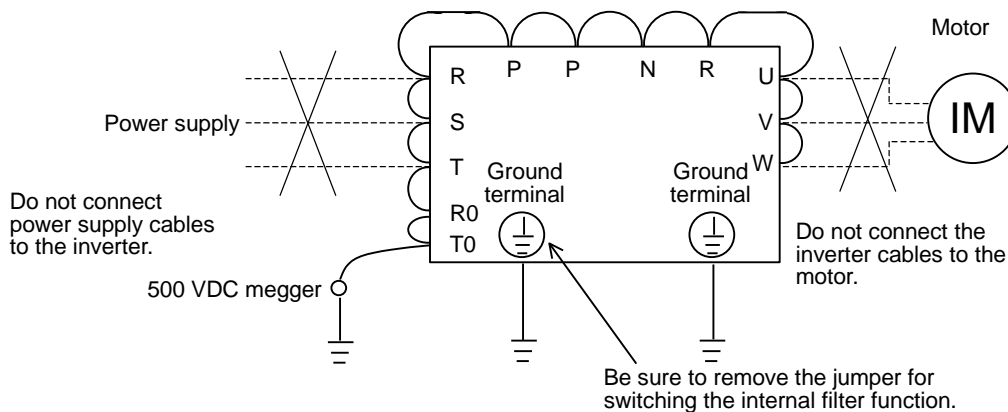

6.4 Withstand Voltage Test

Do not carry out a withstand voltage test for the inverter. The test may damage its internal parts or cause them to deteriorate.

6.5 Method of Checking the Inverter and Converter Circuits

You can check the quality of the inverter and converter circuits by using a tester.

(Preparation)

- 1) Remove the external power supply cables from terminals R, T, and T, the motor cables from terminals U, V, and W, and the regenerative braking resistor cables from terminals P and RB.
- 2) Prepare a tester. (Use the 1Ω-measuring range.)

(Checking method)

Measure the current conduction at each of the inverter's main circuit terminals R, S, T, U, V, W, RB, P, and N while switching the tester polarity alternately.

Note 1: Before checking the circuits, measure the voltage across terminals P and N with the tester in DC voltage range mode to confirm that the smoothing capacitor has fully discharged electricity.

Note 2: When the measured terminal is nonconductive, the tester reads a nearly infinite resistance. The tester may not read the infinite resistance if the measured terminal flows a current momentarily under the influence of the smoothing capacitor.

When the measured terminal is conductive, the tester reading is several ohms to several tens of ohms. The measured values may vary slightly, depending on the types of circuit devices and tester. However, if the values measured at the terminals are almost the same, the inverter and converter circuits have adequate quality.

Note 3: Only inverter models with capacity of 22 kW or less have the BRD circuit.

		Tester polarity		Measurement result
		⊕ (red)	⊖ (black)	
Converter circuit	D1	R	PD	Nonconductive
		PD	R	Conductive
	D2	S	PD	Nonconductive
		PD	S	Conductive
	D3	T	PD	Nonconductive
		PD	T	Conductive
D4	R	N	Conductive	
	N	R	Nonconductive	
D5	S	N	Conductive	
	N	S	Nonconductive	
D6	T	N	Conductive	
	N	T	Nonconductive	
Inverter circuit	TR1	U	P	Nonconductive
		P	U	Conductive
	TR2	V	P	Nonconductive
		P	V	Conductive
	TR3	W	P	Nonconductive
		P	W	Conductive
TR4	U	N	Conductive	
	N	U	Nonconductive	
TR5	V	N	Conductive	
	N	V	Nonconductive	
TR6	W	N	Conductive	
	N	W	Nonconductive	
BRD circuit	TR7	RB	P	Nonconductive
		P	RB	Conductive
		RB	N	Nonconductive
		N	RV	Nonconductive

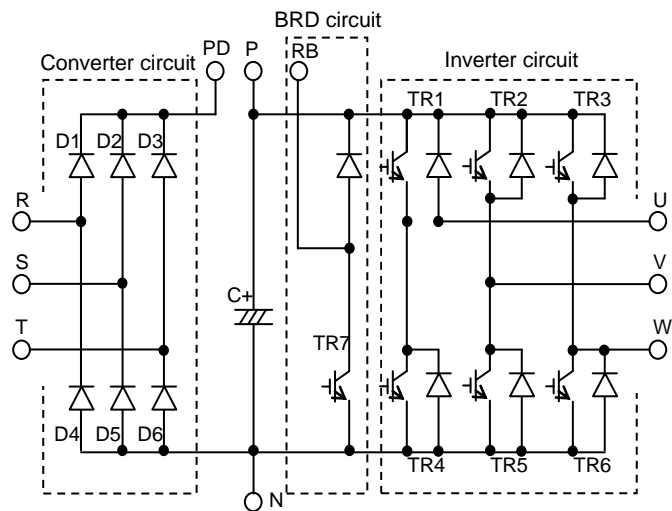

6.6 DC-Bus Capacitor Life Curve

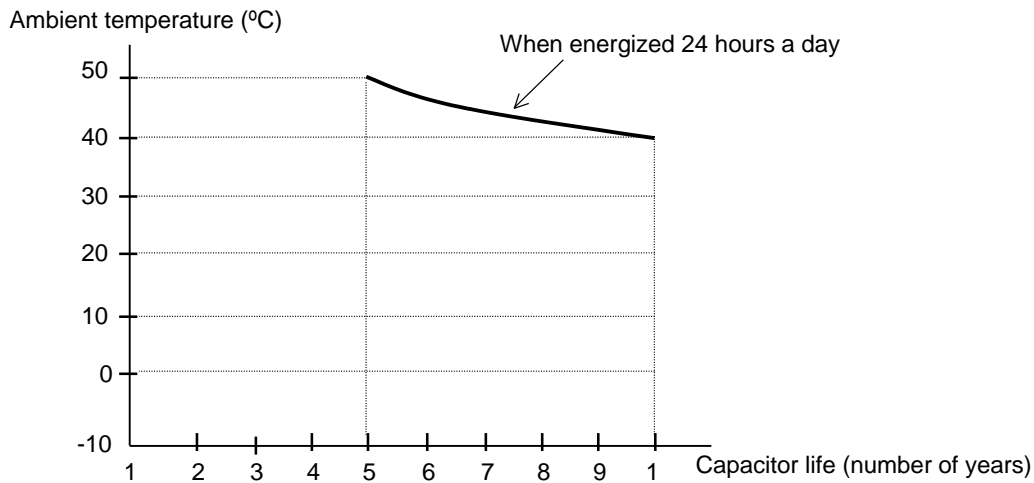

Note 1: The ambient temperature indicates the temperature measured at a position about 5 cm distant from the bottom center of the inverter body. If the inverter is mounted in an enclosure, the ambient temperature is the temperature within the enclosure.

Note 2: The DC-Bus capacitor has a limited life because chemical reactions occur inside the capacitor during operation. You should replace the DC-Bus capacitor after about 10 years of use as standard. (10 years is not the guaranteed lifespan but rather, the expected design lifespan.)
 Note that the smoothing capacitor life will be shortened significantly if the inverter is used at a high ambient temperature or with a heavy load that requires a current beyond its rated current.

6.7 Output of Life Warning

The inverter can output a warning based on self-diagnosis when the life of a life-limited part (smoothing capacitor on the circuit board or cooling fan) (except the smoothing capacitor in the main circuit) in the inverter is expiring. Use the life warning as an indication for the timing of part replacement.

For details, see Sections 4.1.19, "Life-check monitoring," (on page 4-5), 4.2.56, "Intelligent output terminal setting," (on page 4-59), and 4.2.57, "Intelligent output terminal a/b (NO/NC) selection," (on page 4-60).

The self-diagnosis for the life warning is based on the expected design life (which is not the guaranteed life) of each part. The actual parts life may vary depending on the inverter operation environment and conditions.

6.8 Methods of Measuring the Input/Output Voltages, Current, and Power

This section describes the measuring instruments generally used to measure the input and output voltages, output current, and output power of the inverter.

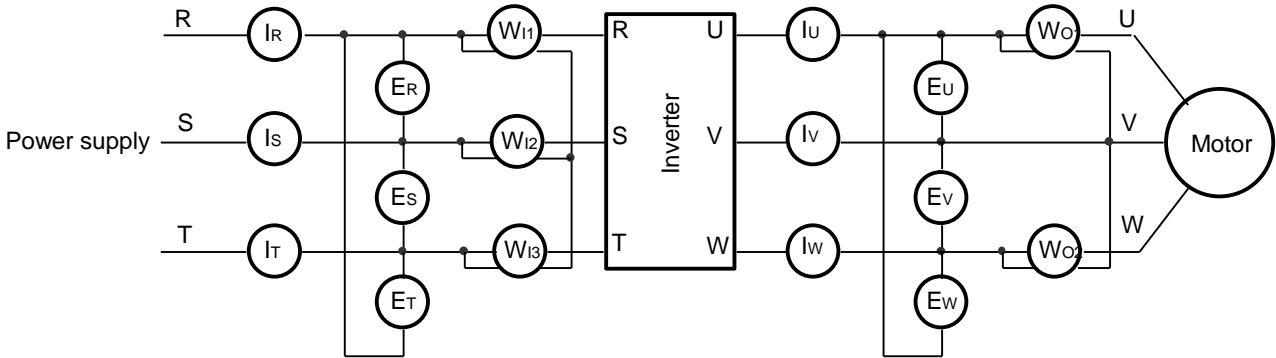

Measurement item	Measuring point	Measuring instrument	Remarks	Reference values
Input voltage (E_{IN})	Across R-S, S-T, and T-R (E_R , (E_S), and (E_T)	Moving-iron voltmeter or rectifier-type voltmeter	Effective value of full waves	200 V class models: 200 to 240 V, 50/60 Hz 400 V class 380 to 480 V, 50/60 Hz
Input current (I_{IN})	Current at R, S, and T (I_R , (I_S), and (I_T)	Moving-iron ammeter	Effective value of full waves	When input currents are unbalanced $I_{IN} = (I_R + I_S + I_T)/3$
Input power (W_{IN})	Across R-S, S-T, and T-R (W_{11}) + (W_{12}) + (W_{13})	Electro-dynamometer-type wattmeter	Effective value of full waves	3-wattmeter method
input power factor (Pf_{IN})	Calculated from the measured input voltage (E_{IN}), input current (I_{IN}), and input power (W_{IN}) $Pf_{IN} = \frac{W_{IN}}{\sqrt{3} \cdot E_{IN} \cdot I_{IN}} \times 100 (\%)$			
Output voltage (E_{OUT})	Across U-V, V-W, and W-U (E_U), (E_V), and (E_W)	Method shown in the figure below or rectifier-type voltmeter	Effective value of fundamental wave	
Output current (I_{OUT})	Current at U, V, and W (I_U), (I_V), and (I_W)	Moving-iron ammeter	Effective value of full waves	
Output power (W_{OUT})	Across U-V and V-W (W_{01}) + (W_{02})	Electro-dynamometer-type wattmeter	Effective value of full waves	2-wattmeter method (or 3-wattmeter method)
Output power factor (Pf_{OUT})	Calculated from the measured input voltage (E_{OUT}), input current (I_{OUT}), and input power (W_{OUT}) $Pf_{OUT} = \frac{W_{OUT}}{\sqrt{3} \cdot E_{OUT} \cdot I_{OUT}} \times 100 (\%)$			

Notes:

- To measure the output voltage, use an instrument that reads the effective value of the fundamental wave. To measure the current or power, use an instrument that reads the effective value of full waves.
- Since the inverter output waveform is controlled by PWM, it has a large margin of error, especially at low frequencies. In many cases, general testers may be inapplicable for the measurement because of the adverse effect of noise.

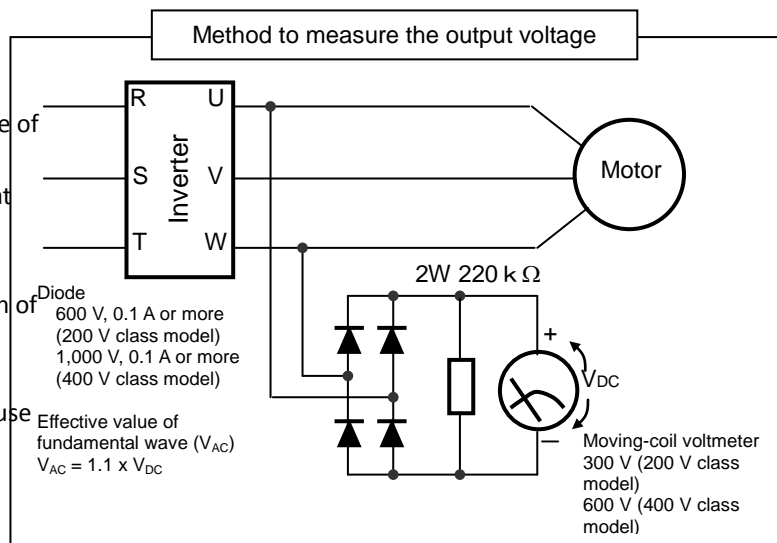

(Memo)

Chapter 7 Specifications



This chapter describes the specifications and external dimensions of the inverter.

- 7.1 Specifications 7-1
- 7.2 External dimensions..... 7-4

7.1 Specifications (CT : Constant torque mode, VT : Variable torque mode)

(1) Specifications of the 200 V class model

Model name (type name) SJ700D-***LFEF3/FUF3		004	007	015	022	037	055	075	110	150	185	220	300	370	450	550	
Max. applicable motor capacity (4-pole) (kW)	CT	0.4	0.75	1.5	2.2	3.7	5.5	7.5	11	15	18.5	22	30	37	45	55	
	VT	0.75	1.5	2.2	3.7	5.5	7.5	11	15	18.5	22	30	37	45	55	75	
Rated capacity (kVA)	200V	CT	1.0	1.7	2.5	3.6	5.7	8.3	11.0	15.9	22.1	26.3	32.9	41.9	50.2	63.0	76.2
		VT	1.2	2.1	3.2	4.1	6.7	10.3	15.2	20.0	25.2	29.4	39.1	48.4	58.5	72.7	93.5
	240V	CT	1.2	2.0	3.1	4.3	6.8	9.9	13.3	19.1	26.6	31.5	39.4	50.2	60.2	75.6	91.4
		VT	1.5	2.6	3.9	4.9	8.1	12.4	18.2	24.1	30.3	35.3	46.9	58.1	70.2	87.2	112.2
Rated input AC voltage		Three-phase (3-wire), 200 to 240 V (+10%, -15%), 50/60 Hz (±5%)															
Rated output voltage		Three-phase (3-wire), 200 to 240 V (corresponding to the input voltage)															
Rated output current (A)	CT	3.0	5.0	7.5	10.5	16.5	24	32	46	64	76	95	121	145	182	220	
	VT	3.7	6.3	9.4	12	19.6	30	44	58	73	85	113	140	169	210	270	
Braking	Regenerative braking	Internal BRD circuit (external discharge resistor)											External regenerative braking unit				
	Minimum connectable resistance (Ω)	50	50	35	35	35	16	10	10	7.5	7.5	5	-				
Approx. weight (kg)		3.5	3.5	3.5	3.5	3.5	6	6	6	14	14	14	22	30	30	43	

(2) Specifications of the 400 V class model

Model name (type name) SJ700D-***HFEF3/FUF3		007	015	022	037 040	055	075	110	150	185	220	300	370	450	550	750	900	1100	1320 1500	
Max. applicable motor capacity (4-pole) (kW)	CT	0.75	1.5	2.2	3.7 4.0	5.5	7.5	11	15	18.5	22	30	37	45	55	75	90	110	132 150	
	VT	1.5	2.2	3.7	5.5	7.5	11	15	18.5	22	30	37	45	55	75	90	110	132	160	
Rated capacity (kVA)	400V	CT	1.7	2.6	3.6	6.2	9.7	13.1	17.3	22.1	26.3	33.2	40.1	51.9	62.3	76.2	103.2	121.9	150.3	180.1
		VT	2.1	3.3	4.6	7.6	11.0	15.2	20.0	25.6	29.7	39.4	48.4	58.8	72.7	93.5	110.8	135	159.3	200.9
	480V	CT	2.0	3.1	4.3	7.4	11.6	15.8	20.7	26.6	31.5	39.9	48.2	62.3	74.8	91.4	123.8	146.3	180.4	216.1
		VT	2.5	3.9	5.5	9.2	13.3	18.2	24.1	30.7	35.7	47.3	58.1	70.6	87.2	112.2	133	162.1	191.2	241.1
Rated input AC voltage		Three-phase (3-wire), 380 to 480 V (+10%, -15%), 50/60 Hz (±5%)																		
Rated output voltage		Three-phase (3-wire), 380 to 480 V (corresponding to the input voltage)																		
Rated output current (A)	CT	2.5	3.8	5.3	9.0	14	19	25	32	38	48	58	75	91	112	149	176	217	260	
	VT	3.1	4.8	6.7	11.1	16	22	29	37	43	57	70	85	105	135	160	195	230	290	
Braking	Regenerative braking	Internal BRD circuit (external discharge resistor)											External regenerative braking unit							
	Minimum connectable resistance (Ω)	100	100	100	70	70	35	35	24	24	20	-								
Approx. weight (kg)		3.5	3.5	3.5	3.5	6	6	6	14	14	14	22	30	30	30	55	55	70	70	

(3) Common specifications of 200 V class and 400 V class models

Model name (type name) SJ700D-***FEF3/FUF3		004 L	007 L/H	015 L/H	022 L/H	037 040 L/H	055 L/H	075 L/H	110 L/H	150 L/H	185 L/H	220 L/H	300 L/H	370 L/H	450 L/H	550 L/H	750 L/H	900 H	1100 H	1320 1500 H
Protective structure		IP20													IP00					
Control system		Sine-wave PWM control																		
Output frequency range		0.1 to 400 Hz (Note 3)																		
Frequency accuracy		Within ±0.01% of the maximum output frequency for digital input, within ±0.2% of maximum frequency for digital input (at 25±10°C)																		
Frequency setting resolution		Digital input: 0.01 Hz Analog input: Maximum output frequency/400 (O terminal input: 12 bits/0 to +10 V, O2 terminal input: 12 bits/-10 to +10 V, O1 terminal input: 12 bits/0 to +20 mA)																		
Voltage/frequency characteristic		IM : V/f characteristic variable with the base frequency set between 30 to 400 Hz, constant- or reduced-torque V/f control, SLV : sensorless vector control, 0Hz-SLV : 0Hz ranged sensorless vector control (only CT), vector with sensor (only CT)																		
Speed fluctuation		±0.5% (with sensorless vector control) Note8)																		
Rated overload current		CT : 150%/60sec, 200%/3sec VT : 120%/60sec, 150%/5sec													CT : 150%/60sec, 180%/3sec VT : 120%/60sec, 150%/5sec					
Acceleration/deceleration time		0.01 to 3,600.0 seconds (in linear or curved pattern)																		
Starting torque	SLV	CT : 200%/0.3Hz VT : 150%/0.5Hz													CT : 180%/0.3Hz VT : 120%/0.5Hz					
	0Hz-SLV	CT : 150%/0Hz range (with motor less one power level than inverter) VT : Disable.													CT : 130% (same as the left) VT : Disable.					

note) There are only 037HFF3, 040HFEF3 and 040HFUF3 as 037/040 model.

note) There are only 1320HFF3, 1320HFEF3 and 1500HFUF3 as 1320/1500 model.

(3) Common specifications of 200 V class and 400 V class models (continued)

Model name (type name)	004	007	015	022	037	055	075	110	150	185	220	300	370	450	550	750	900	1100	1320/1500		
SJ700D-****FEF3/FUF3	L	L/H	L/H	L/H	L/H	L/H	L/H	L/H	L/H	L/H	L/H	L/H	L/H	L/H	L/H	H	H	H	H		
Input	Frequency setting	Standard operator	Setting with  and  keys																		
		External signal (Note6)	0 to +10 VDC, -10 to +10 VDC (input impedance: 10kΩ), 4 to 20 mA (input impedance: 100Ω)																		
		External port	Setting via RS485 communication																		
	Start/stop command Forward/reverse command	Standard operator	Start/stop commands (forward/reverse switching by parameter setting)																		
		External signal	Forward-operation start/stop commands (reverse-operation start/stop possible when relevant commands are assigned to intelligent input terminals) 3-wire input possible (when relevant commands are assigned to control circuit terminals)																		
		External port	Setting via RS485 communication																		
	Intelligent input terminals	8 terminals, NO/NC switchable, sink logic/source logic switchable [Terminal functions] Select eight of 69 functions. Reverse operation (RV), Multispeed 1 setting (CF1), Multispeed 2 setting (CF2), Multispeed 3 setting (CF3), Multispeed 4 setting (CF4), Jogging (JG), external DC braking (DB), 2nd motor control (SET), 2-stage acceleration/deceleration (2CH), free-run stop (FRS), external trip (EXT), unattended start protection (USP), commercial power supply switching (CS), software lock (SFT), analog input switching (AT), 3rd motor control (SET3), reset (RS), starting by 3-wire input (STA), stopping by 3-wire input (STP), forward/reverse switching by 3-wire input (F/R), PID disable (PID), PID integration reset (PIDC), control gain switching (CAS), acceleration by remote control (UP), deceleration by remote control (DWN), data clearance by remote control (UDC), forcible operation (OPE), multispeed bit 1 (SF1), multispeed bit 2 (SF2), multispeed bit 3 (SF3), multispeed bit 4 (SF4), multispeed bit 5 (SF5), multispeed bit 6 (SF6), multispeed bit 7 (SF7), overload restriction selection (OLR), torque limit selection (enabling/disabling) (TL), torque limit 1 (TRQ1), torque limit 2 (TRQ2), P/PI switching (PPI), LAD cancellation (LAC), trigger for frequency addition (A145) (ADD), forcible-terminal operation (F-TM), cumulative power clearance (KHC), general-purpose input 1 (MI1), general-purpose input 2 (MI2), general-purpose input 3 (MI3), general-purpose input 4 (MI4), general-purpose input 5 (MI5), general-purpose input 6 (MI6), general-purpose input 7 (MI7), general-purpose input 8 (MI8), analog command holding (AHD), emergency stop(EMR)*Note4,no assignment (no)																			
	Thermistor input terminal	1 terminal (positive temperature coefficient/negative temperature coefficient switchable for resistor)																			
	Output	Intelligent output terminals	5 open-collector output terminals, NO/NC switchable, sink logic/source logic switchable 1 relay (1c-contact) output terminal: NO/NC switchable [Terminal functions] Select six of 51 functions. Running (RUN), constant-speed reached (FA1), set frequency overreached (FA2), overload notice advance signal (1) (OL), output deviation for PID control (OD), alarm signal (AL), set frequency reached (FA3), over-torque (OTQ), instantaneous power failure (IP), under voltage (UV), torque limited (TRQ), operation time over (RNT), plug-in time over (ONT), thermal alarm signal (THM), 0 Hz detection signal (ZS), set frequency overreached 2 (FA4), set frequency reached 2 (FA5), overload notice advance signal (2) (OL2), PID feedback comparison (FBV), communication line disconnection (NDc), logical operation result 1 (LOG1), logical operation result 2 (LOG2), logical operation result 3 (LOG3), logical operation result 4 (LOG4), logical operation result 5 (LOG5), logical operation result 6 (LOG6), capacitor life warning (WAC), cooling-fan speed drop (WAF), starting contact signal (FR), heat sink overheat warning (OHF), low-current indication signal (LOC), general-purpose output 1 (M01), general-purpose output 2 (M02), general-purpose output 3 (M03), general-purpose output 4 (M04), general-purpose output 5 (M05), general-purpose output 6 (M06), inverter ready (IRDY), forward rotation (FWR), reverse rotation (RVR), major failure (MJA), alarm code 0 to 3 (AC0 to AC3)																		
		Intelligent monitor output terminals	Analog voltage output(Note7), analog current output(Note7), pulse-string output (e.g., A-F, D-F [n-fold, pulse output only], A, T, V, P)																		
Monitoring on display		Output frequency, output current, output torque, frequency conversion data, trip history, input/output terminal status, electric power, and others																			
DC braking	Triggered at motor start-up, when the actual motor frequency exceeds the acceleration frequency set by a stop command, when the actual motor frequency exceeds the frequency set by a frequency command, or by an externally input command (braking force, time, and frequency are variable).																				
Other functions	Free V/f setting (7 breakpoints), frequency upper/lower limit, jump (center) frequency, acceleration/deceleration according to characteristic curve, manual torque boost level/breakpoint, energy-saving operation, analog meter adjustment, start frequency setting, carrier frequency adjustment, electronic thermal function (available also for free setting), external start/end frequency/frequency rate, analog input selection, retry after trip, restart after instantaneous power failure, output of various signals, starting with reduced voltage, overload restriction, initial-value setting, automatic deceleration at power failure, AVR function, fuzzy acceleration/deceleration, online/offline auto-tuning, high-torque multi-motor operation (sensorless vector control of two motors by one inverter)																				
Carrier frequency variation	CT : 0.5 to 15kHz VT : 0.5 to 12 kHz															CT : 0.5 to 10kHz VT : 0.5 to 8 kHz					
Protective functions	Overcurrent protection, overvoltage protection, under voltage protection, electronic thermal protection, temperature error protection, instantaneous power failure protection, phase loss input protection, braking-resistor overload protection, ground-fault current detection at power-on, USP error, external trip, emergency stop trip, CT error, communication error, option board error, and others																				

(3) Common specifications of 200 V class and 400 V class models (continued)

Model name (type name) SJ700D-****F		004 L	007 L/H	015 L/H	022 L/H	037 L/H	055 L/H	075 L/H	110 L/H	150 L/H	185 L/H	220 L/H	300 L/H	370 L/H	450 L/H	550 L/H	750 H	900 H	1100 H	1320/1500 H	
Operating environment	Ambient temperature, storage temperature(Note5), humidity	-10°C to +50°C (ambient), -20°C to +65°C (storage), 20% to 90% RH (no condensation allowed)																			
	Vibration tolerance (See Note 1.)	5.9m/s ² (0.6G),10~55Hz										2.94m/s ² (0.3G),10~55Hz									
	Installation environment	Environment without corrosive gases and dust, at an altitude of 1,000 m or less Note9)																			
Coating color		Grey																			
Optional boards	Feedback option	Vector control with sensor																			
	Digital input option	4-digit BCD input, 16-bit binary input																			
	DeviceNet option	Option to support the open-network DeviceNet function																			
	Profibus-DP option	Option to support the open-network Profibus-DP function																			
Other optional components		LCD operator WOP, digital operator with potentiometer, Braking resistor, AC reactor, DC reactor, Noise filter, Operator cables, Harmonic-wave suppressor unit, LCR filter, Analog operation panel, Regenerative braking unit, Regenerative energy-saving unit, Harmonics suppression unit, Controllers for various applications, PC tool ProdriveNext																			

Note 1: The vibration tolerance was tested in compliance with JIS C60068-2-6:2010 (IEC 60068-2-6:2007).

Note 2: The insulation distance complies with the UL and CE standards.

Note 3: The applicable motor refers to Hitachi standard 3-phase motor(4-pole).when using other motors, care must be taken to prevent the rated motor current(50/60Hz)from exceeding the rated output current of the inverter.

Note 4: Function "64(EMR)"cannot be assigned to input terminal 3 by an operation from the operator. The function is automatically assigned to the terminal when slide switch SW1 is set to ON.

Note 5: The storage temperature refers to the short-term temperature during transport.

Note 6: The frequency command will equal the maximum frequency at 9.8V for input voltage 0 to 10VDC, or at 19.8mA for input current 4 to 20mA.If this characteristic is not satisfactory for your application, contact your Hitachi sales representative.

Note 7: The analog voltage monitor and the analog current monitor are rough output values for analog meter connection.

The maximum output value might shift a little by the difference of the analog output circuit than 10V or 20mA.

Please inquire when there is a possibility that the inconvenience is caused.

Note8: As for the range of the speed change, the variation range is different according to the installation situation and the characteristic and the usage condition of the motor. Please inquire about details.

Note9: The density of air decreases by 1% whenever rising by 100m when the altitude exceeds 1000m. Therefore, it is necessary to decrease the calorific value. The calorific value of the main circuit semiconductor such as IGBT is proportional to the current and the voltage. Therefore, please decrease by 1% and use the current rating every time it rises by 100m.

Please inquire about use in the high ground of 2500m or more.

Note10: When Sensor-less vector control (A044=03), you may not obtain an intended starting torque or motor may trip depending on the applied motor.

Note11: The inverter detects IGBT error (E30) as a protection function.

However IGBT error (E30) is not a protection for an output short circuit, therefore there is a possibility that IGBT will get damaged.

Moreover overcurrent error (E01 to E04) may be detected instead of IGBT error depending on the operational condition of an inverter.

7.2 External dimensions

(200V class) SJ700D-004 to 037 LFF3/LFEF3/LFUF3
 (400V class) SJ700D-007 to 037 HFF3/HFEF3/HFUF3

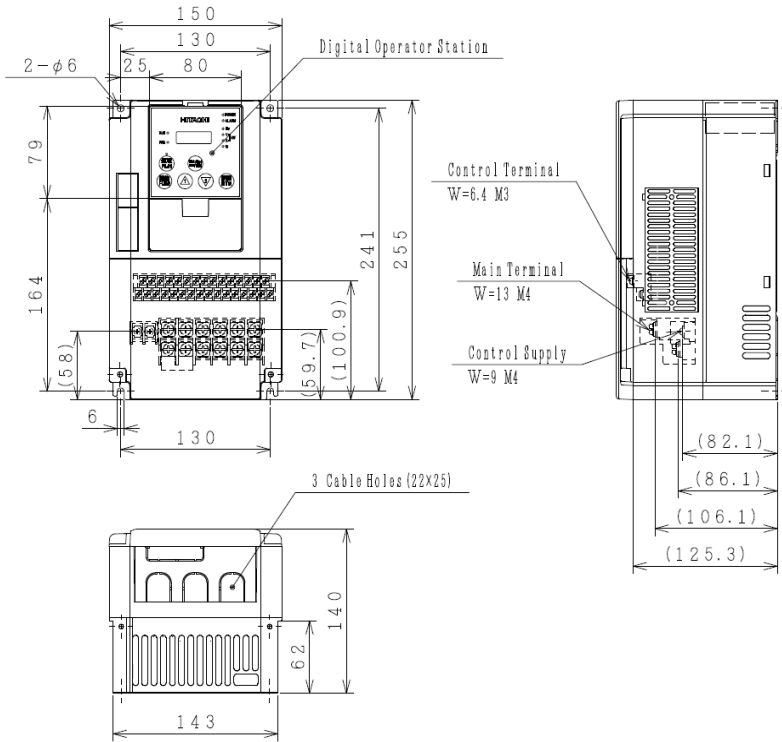

SJ700D-055 to 110 LFF3/LFEF3/LFUF3/HFF3/HFEF3/HFUF3

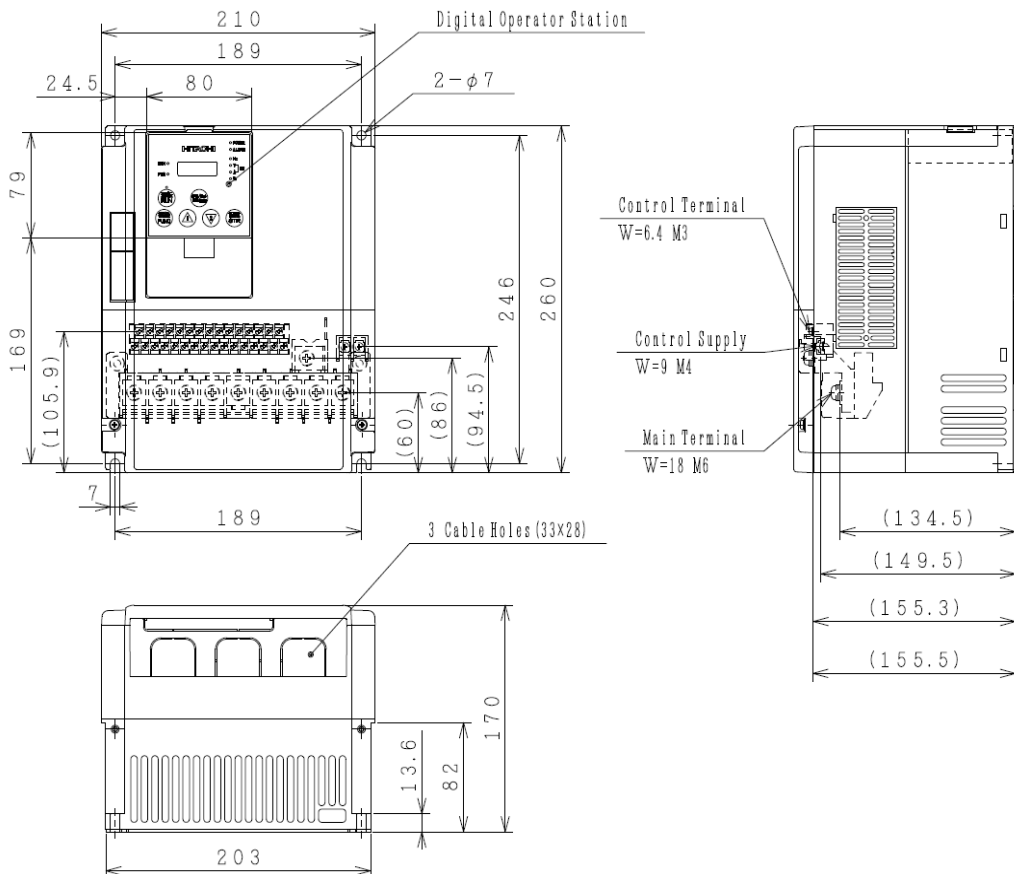

SJ700D-150 to 220 LFF3/LFEF3/LFUF3/HFF3/HFEF3/HFUF3

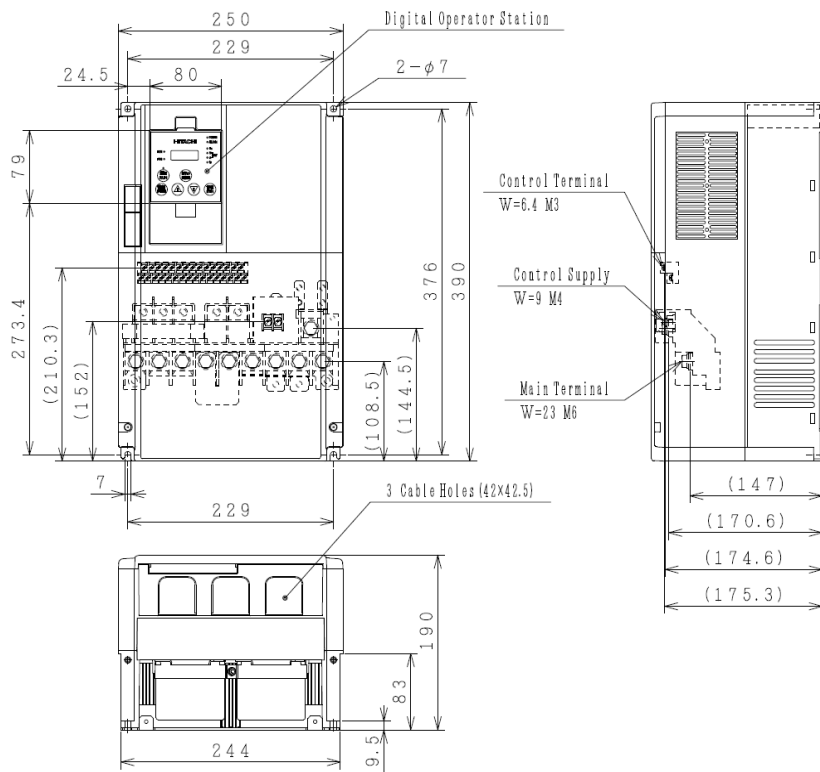

SJ700D-300 LFF3/LFEF3/LFUF3/HFF3/HFEF3/HFUF3

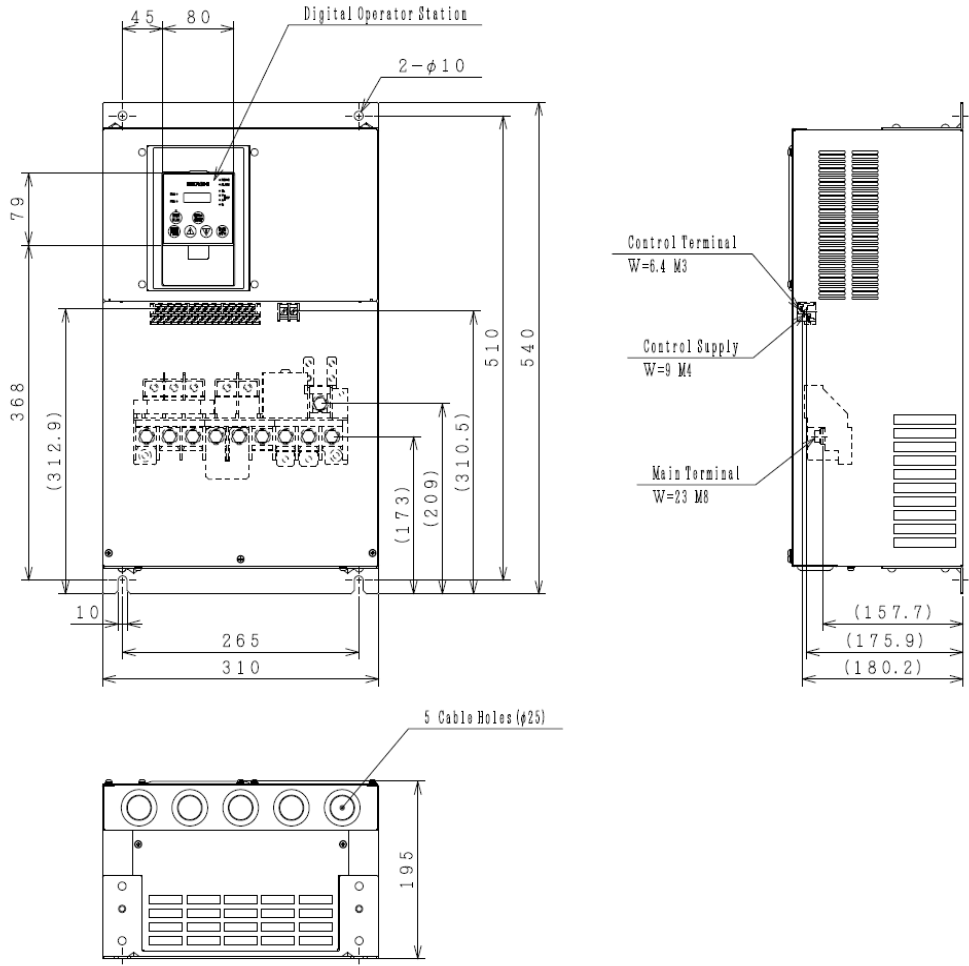

SJ700D-370 to 450 LFF3/LFEF3/LFUF3/HFF3/HFEF3/HFUF3
 SJ700D-550HFF3/HFEF3/HFUF3

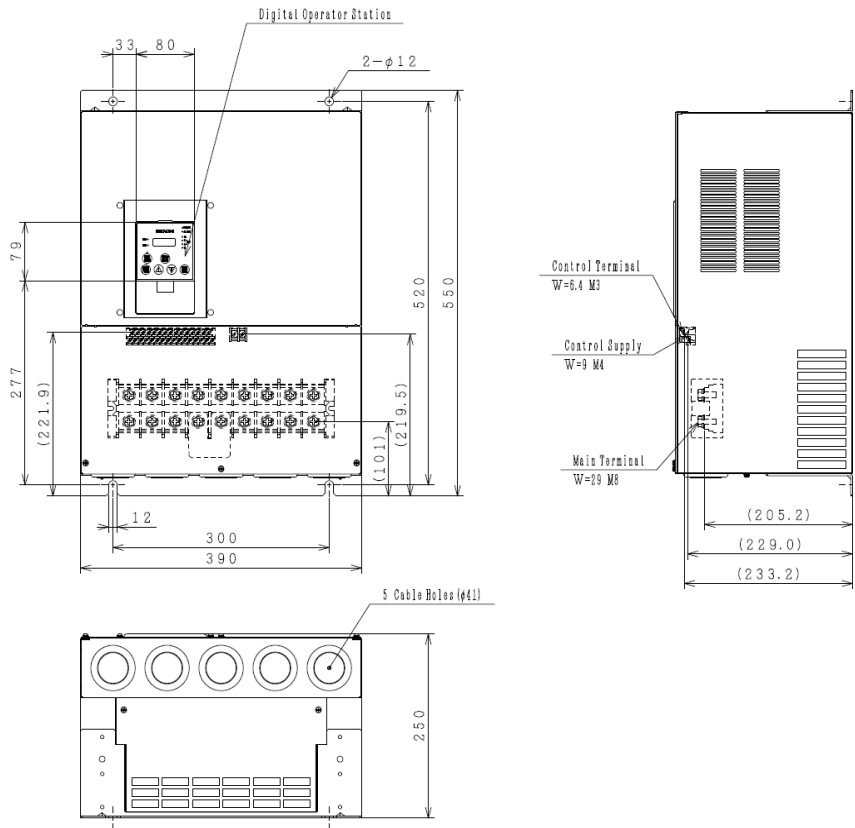

SJ700D-550LFF3/LFEF3/LFUF3

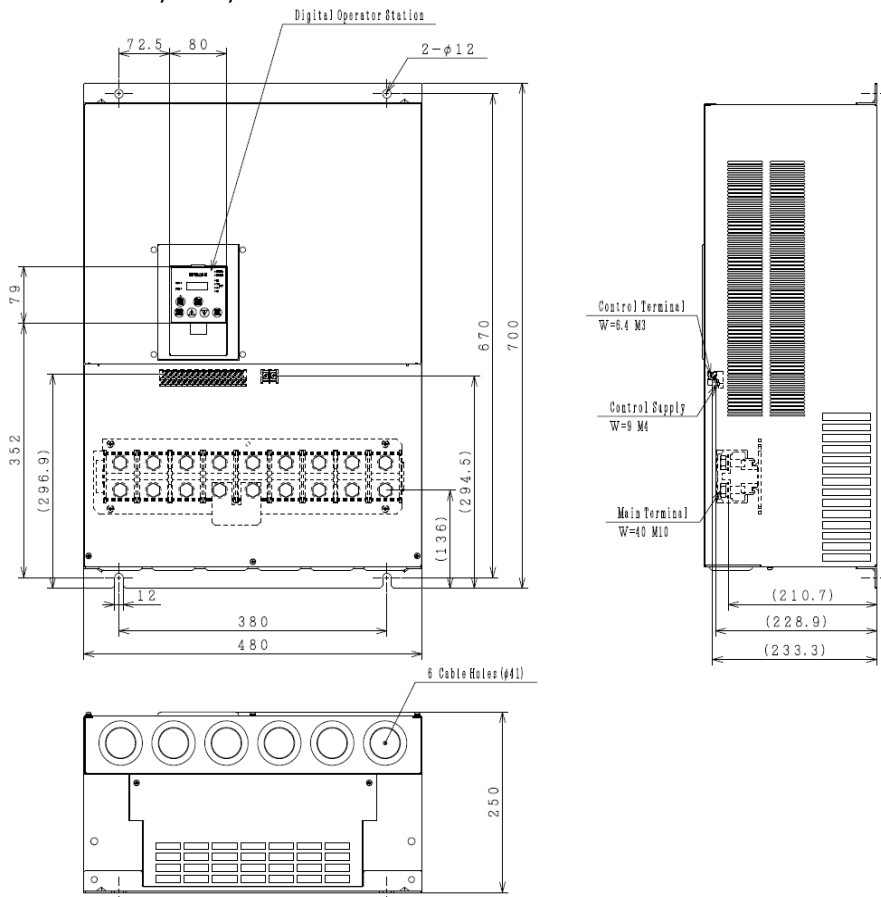

SJ700D-750 to 900 HFF3/HFEF3/HFUF3

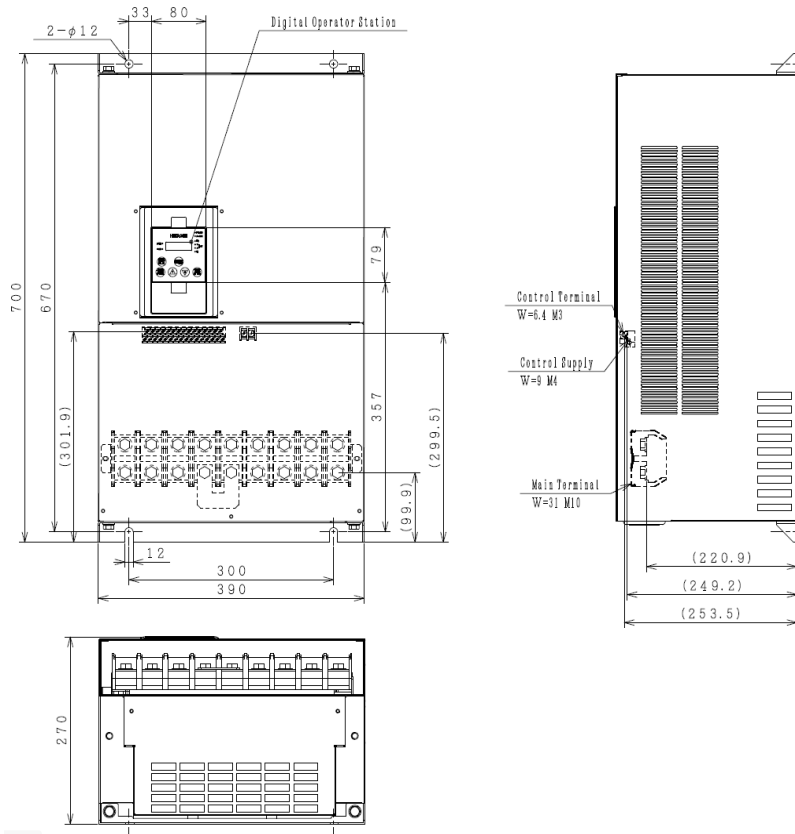

SJ700D-1100HFF3/HFEF3/HFUF3, SJ700D-1320HFF3/HFEF3, SJ700D-1500HFUF3

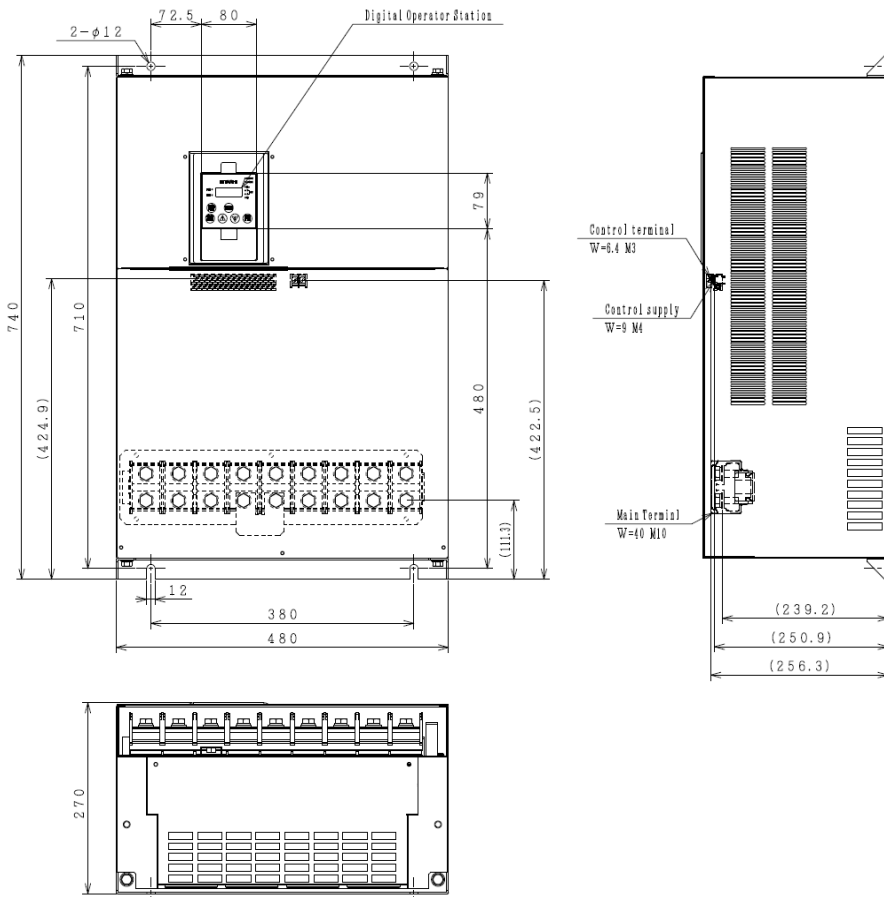

Chapter 8 List of Data Settings

8.1	Precautions for Data Setting	8-1
8.2	Monitoring Mode.....	8-1
8.3	Function Mode.....	8-2
8.4	Extended Function Mode.....	8-3

IMPORTANT! Please be sure to set the motor nameplate data into appropriate parameters to ensure proper operation and protection of the motor.

- *b012 is the motor overload protection value
- *A082 is the motor voltage selection
- *H003 is the motor kW capacity
- *H004 is the number of motor poles

Please refer to the appropriate pages in this guide and the Instruction Manual for further details.

8.1 Precautions for Data Setting

- FF, FEF and FUF are the parts of inverter model.
For example, in case of 1.5kW/400V class, SJ700D-015H***3 (***) is described as FF, FEF or FUF.)
- Even though the inverter is driving the motor, you can change some parameters. If you specify "10" for the software lock mode selection (b031), you can change some more parameters. See the table below.

8.2 Monitoring Mode

With the default settings, the initial display on the operator after powering on is always the output frequency monitor (d001). To change the initial display content, change the setting of the initial-screen selection (b038) as required.

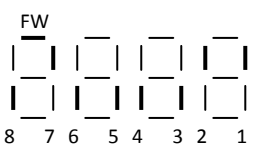
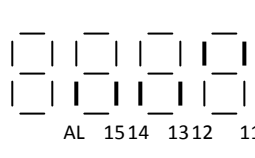
Code	Function name	Monitored data or setting	Default			Change during RUN operation		Page
			FF	FEF	FUF	b031≠10	b031=10	
d001	Output frequency monitoring	0.00 to 99.99, 100.0 to 400.0 (Hz)	-	-	-	Allowed	Allowed	4-1
d002	Output current monitoring	0.0 to 999.9, 1000 to 9999 (A)	-	-	-	-	-	4-1
d003	Rotation direction monitoring	F (forward rotation), o (stopped), r (reverse rotation)	-	-	-	-	-	4-1
d004	Process variable (PV), PID feedback monitoring	0.00 to 99.99, 100.0 to 999.9, 1000. to 9999. 1000 to 9999 (10000 to 99990), $\overline{\text{r}}$ 100 to $\overline{\text{r}}$ 999 (100000 to 999000)	-	-	-	-	-	4-1
d005	Intelligent input terminal status	 (Example) Terminals FW, 7, 2, and 1: ON Terminals 8, 6, 5, 4, and 3: OFF	-	-	-	-	-	4-2
d006	Intelligent output terminal status	 (Example) Terminals 12 and 11: ON Terminals AL, 15, 14, and 13: OFF	-	-	-	-	-	4-2
d007	Scaled output frequency monitoring	0.00 to 99.99, 100.0 to 999.9, 1000. to 9999., 1000 to 3996 (10000 to 39960)	-	-	-	Allowed	Allowed	4-2
d008	Actual-frequency monitoring	-400. to -100., -99.9 to 0.00 to 99.99, 100.0 to 400.0 (Hz)	-	-	-	-	-	4-3
d009	Torque command monitoring	-200. to +200. (%)	-	-	-	-	-	4-3
d010	Torque bias monitoring		-	-	-	-	-	4-3
d012	Torque monitoring		-	-	-	-	-	4-3
d013	Output voltage monitoring	0.0 to 600.0 (V)	-	-	-	-	-	4-3
d014	Power monitoring	0.0 to 999.9 (kW)	-	-	-	-	-	4-3
d015	Cumulative power monitoring	0.0 to 999.9, 1000. to 9999. 1000 to 9999 (10000 to 99990), $\overline{\text{r}}$ 100 to $\overline{\text{r}}$ 999 (100000 to 999000)	-	-	-	-	-	4-4
d016	Cumulative operation RUN time monitoring	0. to 9999., 1000 to 9999 (10000 to 99990), $\overline{\text{r}}$ 100 to $\overline{\text{r}}$ 999 (100000 to 999000) (hr)	-	-	-	-	-	4-4
d017	Cumulative power-on time monitoring		-	-	-	-	-	4-4
d018	Heat sink temperature monitoring	-020. to 200.0 (°C)	-	-	-	-	-	4-4
d019	Motor temperature monitoring		-	-	-	-	-	4-4

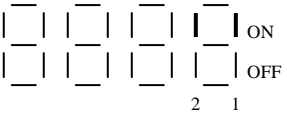
Code	Function name	Monitored data or setting	Default			Change during RUN operation		Page
			FF	FEF	FUF	b031≠10	b031=10	
d022	Life-check monitoring	 1:Capacitor on main circuit board 2:Cooling-fan speed drop	-	-	-	-	-	4-4
d023	Program counter	0 to 1024	-	-	-	-	-	4-5
d024	Program number monitoring	0000 to 9999	-	-	-	-	-	4-5
d025	User monitor 0	-2147483647 to 2147483647 (upper 4 digits including "-")	-	-	-	-	-	4-5
d026	User monitor 1							
d027	User monitor 2							
d028	Pulse counter	0 to 2147483647 (upper 4 digits)	-	-	-	-	-	4-5
d029	Position setting monitor	-1073741823 to 1073741823 (upper 4 digits including "-")	-	-	-	-	-	4-5
d030	Position feedback monitor		-	-	-	-	-	4-5
d031	Clock monitor	* In case you use WOP (option), this monitor is activated.	-	-	-	-	-	-
d060	Inverter mode monitor	I-C(CT)/ I-v(VT)	-	-	-	-	-	4-5
d080	Trip Counter	0. to 9999., 1000 to 6553 (10000 to 65530) (times)	-	-	-	-	-	4-5
d081	Trip monitoring 1	Factor, frequency (Hz), current (A), voltage across P-N (V), running time (hours), power-on time (hours)	-	-	-	-	-	4-6
d082	Trip monitoring 2							
d083	Trip monitoring 3							
d084	Trip monitoring 4							
d085	Trip monitoring 5							
d086	Trip monitoring 6							
d090	Programming error monitoring	Warning code	-	-	-	-	-	4-6
d102	DC voltage monitoring	0.0 to 999.9 (V)	-	-	-	-	-	4-6
d103	BRD load factor monitoring	0.0 to 100.0 (%)	-	-	-	-	-	4-6
d104	Electronic thermal overload monitoring		-	-	-	-	-	4-6

(Note) CT : Constant torque mode, VT : Variable torque mode, you can set CT or VT by b049.

8.3 Function Mode

Code	Function name	Monitored data or setting	Default			Memo	Change during RUN operation		Page
			FF	FEF	FUF		b031≠10	b031=10	
F001	Output frequency setting	0.0, "start frequency" to "maximum frequency" (or maximum frequency, 2nd/3rd motors) (Hz) 0.0 to 100.0 (when PID function is enabled)	0.00				Allowed	Allowed	4-7
F002	Acceleration (1) time setting	0.01 to 99.99, 100.0 to 999.9, 1000. to 3600. (s)	30.00				Allowed	Allowed	4-10
F202	Acceleration (1) time setting, 2nd motor		30.00				Allowed	Allowed	4-10
F302	Acceleration (1) time setting, 3rd motor		30.00				Allowed	Allowed	4-10
F003	Deceleration (1) time setting	0.01 to 99.99, 100.0 to 999.9, 1000. to 3600. (s)	30.00				Allowed	Allowed	4-10
F203	Deceleration time setting, 2nd motor		30.00				Allowed	Allowed	4-10
F303	Deceleration time setting, 3rd motor		30.00				Allowed	Allowed	4-10
F004	Keypad Run key routing	00 (forward rotation), 01 (reverse rotation)	00				Not	Not	4-7

8.4 Extended Function Mode

Code	Function name	Monitored data or setting	Default			Memo	Change during RUN operation		Page	
			FF	FEF	FUF		b031≠10	b031=10		
Basic settings	A001	Frequency source setting	00 (keypad potentiometer) (*1), 01 (control circuit terminal block), 02 (digital operator), 03 (RS485), 04 (option 1), 05 (option 2), 06 (pulse-string input), 07 (easy sequence), 10 (operation function result)	02	01	01		Not	Not	4-8
	A002	Run command source setting	01 (control circuit terminal block), 02 (digital operator), 03 (RS485), 04 (option 1), 05 (option 2)	02	01	01		Not	Not	4-8
	A003	Base frequency setting	30. to "Maximum frequency" (Hz)	60.	50.	60.		Not	Not	4-11
	A203	Base frequency setting, 2nd motor	30. to "Maximum frequency, 2nd motor" (Hz)	60.	50.	60.		Not	Not	
	A303	Base frequency setting, 3rd motor	30. to "Maximum frequency, 3rd motor" (Hz)	60.	50.	60.		Not	Not	
	A004	Maximum frequency setting	"Base frequency setting" to 400. (Hz)	60.	50.	60.		Not	Not	4-11
	A204	Maximum frequency setting, 2nd motor	"Base frequency setting, 2nd motor" to 400. (Hz)	60.	50.	60.		Not	Not	
A304	Maximum frequency setting, 3rd motor	"Base frequency setting, 3rd motor" to 400. (Hz)	60.	50.	60.		Not	Not		
Analog input and others	A005	[AT] selection	00 (switching between O and OI terminals), 01 (switching between O and O2 terminals), 02 (switching between O terminal and keypad potentiometer) (*1), 03 (switching between OI terminal and keypad potentiometer) (*1), 04 (switching between O2 and keypad potentiometer) (*1)		00			Not	Not	4-12
	A006	[O2] selection	00 (single), 01 (auxiliary frequency input via O and OI terminals) (nonreversible), 02 (auxiliary frequency input via O and OI terminals) (reversible), 03 (disabling O2 terminal)		03			Not	Not	
	A011	[O]-[L] input active range start frequency	0.00 to 99.99, 100.0 to 400.0 (Hz)		0.00			Not	Allowed	4-14
	A012	[O]-[L] input active range end frequency	0.00 to 99.99, 100.0 to 400.0 (Hz) (In case of setting 0.00, internal setting is "Maximum frequency")		0.00			Not	Allowed	
	A013	[O]-[L] input active range start voltage	0. to "[O]-[L] input active range end voltage" (%)		0.			Not	Allowed	
	A014	[O]-[L] input active range end voltage	"[O]-[L] input active range start voltage" to 100. (%)		100.			Not	Allowed	
	A015	[O]-[L] input active range start frequency selection	00 (external start frequency), 01 (0 Hz)		01			Not	Allowed	
	A016	External frequency filter time const.	1. to 30. or 31. (500 ms filter ±0.1 Hz with hysteresis)		31.			Not	Allowed	4-15
	A017	Easy sequence function selection	00 (disabling), 01 (enabling)		00			Not	Not	4-95
	Multispeed operation and jogging	A019	Multispeed operation selection	00 (binary: 16 speeds selectable with 4 terminals), 01 (bit: 8 speeds selectable with 7 terminals)		00			Not	Not
A020		Multispeed frequency setting	0.0 or "start frequency" to "maximum frequency" (Hz)		0.00			Allowed	Allowed	
A220		Multispeed frequency setting, 2nd motor	0.0 or "start frequency" to "maximum frequency, 2nd motor" (Hz)		0.00			Allowed	Allowed	
A320		Multispeed frequency setting, 3rd motor	0.0 or "start frequency" to "maximum frequency, 3rd motor" (Hz)		0.00			Allowed	Allowed	
A021		Multispeed 1 setting	0.0 or "start frequency" to "1st maximum frequency" (Hz) (n=1 to 3)		0.00			Allowed	Allowed	
A022		Multispeed 2 setting	0.0 or "start frequency" to "1st maximum frequency" (Hz) (n=1 to 3)		0.00			Allowed	Allowed	
A023		Multispeed 3 setting	0.0 or "start frequency" to "1st maximum frequency" (Hz) (n=1 to 3)		0.00			Allowed	Allowed	
A024		Multispeed 4 setting	0.0 or "start frequency" to "1st maximum frequency" (Hz) (n=1 to 3)		0.00			Allowed	Allowed	
A025		Multispeed 5 setting	0.0 or "start frequency" to "1st maximum frequency" (Hz) (n=1 to 3)		0.00			Allowed	Allowed	
A026		Multispeed 6 setting	0.0 or "start frequency" to "1st maximum frequency" (Hz) (n=1 to 3)		0.00			Allowed	Allowed	
A027		Multispeed 7 setting	0.0 or "start frequency" to "1st maximum frequency" (Hz) (n=1 to 3)		0.00			Allowed	Allowed	
A028		Multispeed 8 setting	0.0 or "start frequency" to "1st maximum frequency" (Hz) (n=1 to 3)		0.00			Allowed	Allowed	
A029		Multispeed 9 setting	0.0 or "start frequency" to "1st maximum frequency" (Hz) (n=1 to 3)		0.00			Allowed	Allowed	
A030		Multispeed 10 setting	0.0 or "start frequency" to "1st maximum frequency" (Hz) (n=1 to 3)		0.00			Allowed	Allowed	
A031		Multispeed 11 setting	0.0 or "start frequency" to "1st maximum frequency" (Hz) (n=1 to 3)		0.00			Allowed	Allowed	
A032		Multispeed 12 setting	0.0 or "start frequency" to "1st maximum frequency" (Hz) (n=1 to 3)		0.00			Allowed	Allowed	
A033		Multispeed 13 setting	0.0 or "start frequency" to "1st maximum frequency" (Hz) (n=1 to 3)		0.00			Allowed	Allowed	
A034	Multispeed 14 setting	0.0 or "start frequency" to "1st maximum frequency" (Hz) (n=1 to 3)		0.00			Allowed	Allowed		
A035	Multispeed 15 setting	0.0 or "start frequency" to "1st maximum frequency" (Hz) (n=1 to 3)		0.00			Allowed	Allowed		
A038	Jog frequency setting	"Start frequency" to 9.99 (Hz)		1.00			Allowed	Allowed		
A039	Jog stop mode	00 (free-running after jogging stops [disabled during operation]), 01 (deceleration and stop after jogging stops [disabled during operation]), 02 (DC braking after jogging stops [disabled during operation]), 03 (free-running after jogging stops [enabled during operation]), 04 (deceleration and stop after jogging stops [enabled during operation]), 05 (DC braking after jogging stops [enabled during operation])		00			Not	Allowed	4-49	

*1 This setting is valid only when the OPE-SR is connected.

Code	Function name	Monitored data or setting	Default			Memo	Change during RUN operation		Page	
			FF	FEF	FUF		b031≠10	b031=10		
V/f characteristic	A041	Torque boost method selection	00 (manual torque boost), 01 (automatic torque boost)			00		Not	Not	4-18
	A241	Torque boost method selection, 2nd motor				00		Not	Not	
	A042	Manual torque boost value				1.0		Allowed	Allowed	
	A242	Manual torque boost value, 2nd motor	0.0 to 20.0 (%)			1.0		Allowed	Allowed	
	A342	Manual torque boost value, 3rd motor				1.0		Allowed	Allowed	
	A043	Manual torque boost frequency adjustment				5.0		Allowed	Allowed	
	A243	Manual torque boost frequency adjustment, 2nd motor	0.0 to 50.0 (%)			5.0		Allowed	Allowed	
	A343	Manual torque boost frequency adjustment, 3rd motor				5.0		Allowed	Allowed	
	A044	V/f characteristic curve selection, 1st motor	00 (VC), 01 (VP), 02 (free V/f), 03 (sensorless vector control), 04 (0Hz sensorless vector control)(only CT), 05(vector with sensor)(only CT)			00		Not	Not	4-16
	A244	V/f characteristic curve selection, 2nd motor	00 (VC), 01 (VP), 02 (free V/f), 03 (sensorless vector control), 04 (0Hz sensorless vector control)(only CT)			00		Not	Not	
	A344	V/f characteristic curve selection, 3rd motor	00(VC), 01(VP)			00		Not	Not	
	A045	V/f gain setting	20. to 100. (%)			100.		Allowed	Allowed	4-15
	A046	Voltage compensation gain setting for automatic torque boost. 1st motor	0. to 255.			100.		Allowed	Allowed	4-18
	A246	Voltage compensation gain setting for automatic torque boost, 2nd motor				100.		Allowed	Allowed	
A047	Slippage compensation gain setting for automatic torque boost, 1st motor	0. to 255.			100.		Allowed	Allowed		
A247	Slippage compensation gain setting for automatic torque boost, 2nd motor				100.		Allowed	Allowed		
DC braking	A051	DC braking enable	00 (disabling), 01 (enabling), 02 (set frequency only)			00		Not	Allowed	4-20
	A052	DC braking frequency setting	0.00 to 99.99, 100.0 to 400.0 (Hz)			0.50		Not	Allowed	
	A053	DC braking wait time	0.0 to 5.0 (s)			0.0		Not	Allowed	
	A054	DC braking force during deceleration	0. to 100. (%) <0. to 80. (%)> (In case of CT) 0. to 70. (%) <0. to 50. (%)> (In case of VT)			20.		Not	Allowed	
	A055	DC braking time for deceleration	0.0 to 60.0 (s)			0.0		Not	Allowed	
	A056	DC braking/edge or level detection for [DB] input	00 (edge operation), 01 (level operation)			01		Not	Allowed	
	A057	DC braking force for starting	0. to 100. (%) <0. to 80. (%)> (In case of CT) 0. to 70. (%) <0. to 50. (%)> (In case of VT)			0.		Not	Allowed	
	A058	DC braking time for starting	0.0 to 60.0(s)			0.0		Not	Allowed	
	A059	DC braking carrier frequency setting	0.5 to 15.0(kHz) <0.5 to 10.0 (kHz) > (In case of CT) 0.5 to 12.0(kHz) <0.5 to 8.0 (kHz) > (In case of VT)			5.0<3.0> (CT) 3.0 (VT)		Not	Allowed	
Frequency upper/lower limit and jump frequency	A061	Frequency upper limit setting	0.00 or "1st minimum frequency limit" to "maximum frequency" (Hz)			0.00		Not	Allowed	4-24
	A261	Frequency upper limit setting, 2nd motor	0.00 or "2nd minimum frequency limit" to "maximum frequency, 2nd motor" (Hz)			0.00		Not	Allowed	
	A062	Frequency lower limit setting	0.00 or "start frequency" to "maximum frequency limit" (Hz)			0.00		Not	Allowed	
	A262	Frequency lower limit setting, 2nd motor	0.00 or "start frequency" to "maximum frequency, 2nd motor limit" (Hz)			0.00		Not	Allowed	
	A063	Jump (center) frequency setting 1	0.00 to 99.99, 100.0 to 400.0 (Hz)			0.00		Not	Allowed	4-25
	A064	Jump (hysteresis) frequency width setting 1	0.00 to 10.00 (Hz)			0.50		Not	Allowed	
	A065	Jump (center) frequency setting 2	0.00 to 99.99, 100.0 to 400.0 (Hz)			0.00		Not	Allowed	
	A066	Jump (hysteresis) frequency width setting 2	0.00 to 10.00 (Hz)			0.50		Not	Allowed	
	A067	Jump (center) frequency setting 3	0.00 to 99.99, 100.0 to 400.0 (Hz)			0.00		Not	Allowed	
	A068	Jump (hysteresis) frequency width setting 3	0.00 to 10.00 (Hz)			0.50		Not	Allowed	
A069	Acceleration stop frequency setting	0.00 to 99.99, 100.0 to 400.0 (Hz)			0.00		Not	Allowed	4-26	
A070	Acceleration stop time frequency setting	0.0 to 60.0 (s)			0.0		Not	Allowed		
PID control	A071	PID Function Enable	00 (disabling), 01 (enabling), 02 (enabling inverted-data output)			00		Not	Allowed	4-26
	A072	PID proportional gain	0.2 to 5.0			1.0		Allowed	Allowed	
	A073	PID integral time constant	0.0 to 999.9, 1000. to 3600. (s)			1.0		Allowed	Allowed	
	A074	PID derivative gain	0.00 to 99.99, 100.0 (s)			0.00		Allowed	Allowed	
	A075	PV scale conversion	0.01 to 99.99			1.00		Not	Allowed	
	A076	PV source setting	00 (input via OI), 01 (input via O), 02 (external communication), 03 (pulse-string frequency input), 10 (operation result output)			00		Not	Allowed	
	A077	Output of inverted PID deviation	00(OFF), 01 (ON)			00		Not	Allowed	
	A078	PID variation range	0.0 to 100.0 (%)			0.00		Not	Allowed	
	A079	PID feed forward selection	00 (disabled), 01 (O input), 02 (OI input), 03 (O2 input)			00		Not	Allowed	

(Note)<->indicate the setting range of 75 to 150kW

(Note) CT : Constant torque mode, VT : Variable torque mode, you can set CT or VT by b049.

Code	Function name	Monitored data or setting	Default			Memo	Change during RUN operation		Page		
			FF	FEF	FUF		b031=10	b031=10			
AVR	A081	AVR function select	00 (always on), 01 (always off), 02 (off during deceleration)			02	00	00	Not	Not	4-11
	A082	AVR voltage select	200 V class: 200, 215, 220, 230, 240 (V) 400 V class: 380, 400, 415, 440, 460, 480 (V)			200/ 400	230/ 400	230/ 460	Not	Not	
Operation mode and acceleration/deceleration function	A085	Operation mode selection	00 (normal operation), 01 (energy-saving operation), 02 (fuzzy operation)(only CT)			00			Not	Not	4-32
	A086	Energy saving mode tuning	0.1 to 100.0			50.0			Allowed	Allowed	
	A092	Acceleration (2) time setting	0.01 to 99.99, 100.0 to 999.9, 1000. to 3600. (s)			15.00			Allowed	Allowed	
	A292	Acceleration (2) time setting, 2nd motor				15.00			Allowed	Allowed	
	A392	Acceleration (2) time setting, 3rd motor				15.00			Allowed	Allowed	
	A093	Deceleration (2) time setting				15.00			Allowed	Allowed	
	A293	Deceleration (2) time setting, 2nd motor	0.01 to 99.99, 100.0 to 999.9, 1000. to 3600. (s)			15.00			Allowed	Allowed	4-30
	A393	Deceleration (2) time setting, 3rd motor				15.00			Allowed	Allowed	
	A094	Select method to switch to Acc2/Dec2 profile	00 (switching by 2CH terminal), 01 (switching by setting), 02 (switching only when rotation is reversed)			00			Not	Not	
	A294	Select method to switch to Acc2/Dec2, 2nd motor	00 (switching by 2CH terminal), 01 (switching by setting), 02 (switching only when rotation is reversed)			00			Not	Not	
	A095	Acc1 to Acc2 frequency transition point	0.00 to 99.99, 100.0 to 400.0 (Hz)			0.00			Not	Not	4-31
	A295	Acc1 to Acc2 frequency transition point, 2nd motor				0.00			Not	Not	
	A096	Dec1 to Dec2 frequency transition point	0.00 to 99.99, 100.0 to 400.0 (Hz)			0.00			Not	Not	
	A296	Dec1 to Dec2 frequency transition point, 2nd motor				0.00			Not	Not	
A097	Acceleration curve selection	00 (linear), 01 (S curve), 02 (U curve), 03 (inverted-U curve), 04 (EL-S curve)			00			Not	Not		
A098	Deceleration curve setting				00			Not	Not		
External frequency adjustment	A101	[O1]-[L] input active range start frequency	0.00 to 99.99, 100.0 to 400.0 (Hz)			0.00			Not	Allowed	4-14
	A102	[O1]-[L] input active range end frequency	0.00 to 99.99, 100.0 to 400.0 (Hz) (In case of setting 0.00, internal setting is "Maximum frequency")			0.00			Not	Allowed	
	A103	[O1]-[L] input active range start current	0. to "[O1]-[L] input active range end current" (%)			20.			Not	Allowed	
	A104	[O1]-[L] input active range end current	"[O1]-[L] input active range start current" to 100. (%)			100.			Not	Allowed	
	A105	[O1]-[L] input start frequency enable	00 (external start frequency), 01 (0 Hz)			00			Not	Allowed	
	A111	[O2]-[L] input active range start frequency	-400. to -100., -99.9 to 0.00 to 99.99, 100.0 to 400.0 (Hz)			0.00			Not	Allowed	
	A112	[O2]-[L] input active range end frequency	-400. to -100., -99.9 to 0.00 to 99.99, 100.0 to 400.0 (Hz)			0.00			Not	Allowed	
	A113	[O2]-[L] input active range start voltage	-100. to 02 end-frequency rate (%)			-100.			Not	Allowed	
A114	[O2]-[L] input active range end voltage	"02 start-frequency rate" to 100. (%)			100.			Not	Allowed		
Acceleration and deceleration	A131	Acceleration curve constants setting	01 (smallest swelling) to 10 (largest swelling)			02			Not	Allowed	4-31
	A132	Deceleration curve constants setting	01 (smallest swelling) to 10 (largest swelling)			02			Not	Allowed	
Operation-target frequency	A141	Operation-target frequency selection 1	00 (digital operator), 01 (keypad potentiometer), 02 (input via O), 03 (input via O1), 04 (external communication), 05 (option 1), 06 (option 2), 07 (pulse-string frequency input)			02			Not	Allowed	4-13
	A142	Operation-target frequency selection 2				03			Not	Allowed	
	A143	Operator selection	00 (addition: A141 + A142), 01 (subtraction: A141 - A142), 02 (multiplication: A141 x A142)			00			Not	Allowed	
	A145	Frequency to be added	0.00 to 99.99, 100.0 to 400.0 (Hz)			0.00			Not	Allowed	
Acceleration and deceleration	A146	Sign of the frequency to be added	00 (frequency command + A145), 01 (frequency command - A145)			00			Not	Allowed	4-14
	A150	EL-S-curve acceleration ratio 1	0. to 50. (%)			25.			Not	Not	
A151	EL-S-curve acceleration ratio 2	25.				Not	Not				
A152	EL-S-curve deceleration ratio 1	0. to 50. (%)			25.			Not	Not		
A153	EL-S-curve deceleration ratio 2				25.			Not	Not		

*1 This setting is valid only when the OPE-SR is connected.
(Note) CT : Constant torque mode, VT : Variable torque mode, you can set CT or VT by b049.

Code	Function name	Monitored data or setting	Default			Memo	Change during RUN operation		Page	
			FF	FEF	FUF		b031≠10	b031=10		
Restart after instantaneous power failure or tripping	b001	Selection of restart mode	00 (tripping), 01 (starting with 0 Hz), 02 (starting with matching frequency), 03 (tripping after deceleration and stopping with matching frequency), 04 (restarting with active matching frequency)			00		Not	Allowed	4-33
	b002	Allowable under-voltage power failure time	0.3 to 25.0 (s)			1.0		Not	Allowed	
	b003	Retry wait time before motor restart	0.3 to 100.0 (s)			1.0		Not	Allowed	
	b004	Instantaneous power failure/under-voltage trip alarm enable	00 (disabling), 01 (enabling), 02 (disabling during stopping and decelerating to stop)			00		Not	Allowed	4-36
	b005	Number of restarts on power failure/under-voltage trip events	00 (16 times), 01 (unlimited)			00		Not	Allowed	
	b006	Input phase loss detection enable	00 (disabling), 01 (enabling)			00		Not	Allowed	
	b007	Restart frequency threshold	0.00 to 99.99, 100.0 to 400.0 (Hz)			0.00		Not	Allowed	
Restart after undervoltage	b008	Selection of retry after tripping	00 (tripping), 01 (starting with 0 Hz), 02 (starting with matching frequency), 03 (tripping after deceleration and stopping with matching frequency), 04 (restarting with active matching frequency)			00		Not	Allowed	4-33
	b009	Selection of retry after undervoltage	00 (16 times), 01 (unlimited)			00		Not	Allowed	
	b010	Selection of retry count after overvoltage or overcurrent	1 to 3 (times)			3		Not	Allowed	
	b011	Retry wait time after tripping	0.3 to 100.0 (s)			1.0		Not	Allowed	
Electronic thermal function	b012	Electronic thermal setting	Rated current					Not	Allowed	4-37
	b212	Electronic thermal setting, 2nd motor	0.20 x "rated current" to 1.00 x "rated current" (A)					Not	Allowed	
	b312	Electronic thermal setting, 3rd motor	Rated current					Not	Allowed	
	b013	Electronic thermal characteristic	00 (reduced-torque characteristic), 01 (constant-torque characteristic), 02 (free setting)			00	01	01	Not	Allowed
	b213	Electronic thermal characteristic, 2nd motor	00 (reduced-torque characteristic), 01 (constant-torque characteristic), 02 (free setting)			00	01	01	Not	Allowed
	b313	Electronic thermal characteristic, 3rd motor	00 (reduced-torque characteristic), 01 (constant-torque characteristic), 02 (free setting)			00	01	01	Not	Allowed
	b015	Free setting, electronic thermal frequency (1)	0. to 400. (Hz)			0.		Not	Allowed	4-38
b016	Free setting, electronic thermal current (1)	0.0 to rated current (A)			0.0		Not	Allowed		
b017	Free setting, electronic thermal frequency (2)	0. to 400. (Hz)			0.		Not	Allowed		
b018	Free setting, electronic thermal current (2)	0.0 to rated current (A)			0.0		Not	Allowed		
b019	Free setting, electronic thermal frequency (3)	0. to 400. (Hz)			0.		Not	Allowed		
b020	Free setting, electronic thermal current (3)	0.0 to rated current (A)			0.0		Not	Allowed		
Overload restriction and overcurrent restraint	b021	Overload restriction operation mode	00 (disabling), 01 (enabling during acceleration and deceleration), 02 (enabling during constant speed), 03 (enabling during acceleration and deceleration (increasing the speed during regeneration))			01		Not	Allowed	4-39
	b022	Overload restriction setting	0.20 x "rated current" to 2.00 x "rated current" (A) <0.20 x "rated current" to 1.80 x "rated current" (A)> (In case of CT) 0.20 x "rated current" to 1.50 x "rated current" (A) (In case of VT)			Rated current x 1.50 (CT) Rated current x 1.20 (VT)		Not	Allowed	
	b023	Deceleration rate at overload restriction	0.10 to 30.00 (s)			1.00		Not	Allowed	
	b024	Overload restriction operation mode (2)	00 (disabling), 01 (enabling during acceleration and deceleration), 02 (enabling during constant speed), 03 (enabling during acceleration and deceleration (increasing the speed during regeneration))			01		Not	Allowed	
	b025	Overload restriction setting (2)	0.20 x "rated current" to 1.50 x "rated current" (A) <0.20 x "rated current" to 1.50 x "rated current" (A)>			Rated current x 1.50 (CT) Rated current x 1.20 (VT)		Not	Allowed	
	b026	Deceleration rate at overload restriction (2)	0.10 to 30.00 (s)			1.00		Not	Allowed	
	b027	Overcurrent suppression enable	00 (disabling), 01 (enabling)			01		Not	Allowed	
Overload restriction and overcurrent restraint	b028	Active frequency matching, scan start frequency	0.20 x "rated current" to 2.00 x "rated current" (A) <0.20 x "rated current" to 1.80 x "rated current" (A)> (In case of CT) 0.20 x "rated current" to 1.50 x "rated current" (A) (In case of VT)			Rated current		Not	Allowed	4-33
	b029	Active frequency matching, scan-time constant	0.10 to 30.00 (s)			0.50		Not	Allowed	
	b030	Active frequency matching, restart frequency select	00 (frequency at the last shutoff), 01 (maximum frequency), 02 (set frequency)			00		Not	Allowed	
Software lock	b031	Software lock mode selection	00 (disabling change of data other than "b031" when SFT is on), 01 (disabling change of data other than "b031" and frequency settings when SFT is on), 02 (disabling change of data other than "b031"), 03 (disabling change of data other than "b031" and frequency settings), 10 (enabling data changes during operation)			01		Not	Allowed	4-51

(Note)<>indicate the setting range of 75 to 150kW

(Note) CT : Constant torque mode, VT : Variable torque mode, you can set CT or VT by b049.

Code	Function name	Monitored data or setting	Default			Memo	Change during RUN operation		Page	
			FF	FEF	FUF		b031≠10	b031=10		
Others	b034	Run/power-on warning time	0. to 9999. (0 to 99990), 1000 to 6553 (100000 to 655300) (hr)			0.		Not	Allowed	4-64
	b035	Rotational direction restriction	00 (enabling both forward and reverse rotations), 01 (enabling only forward rotation), 02 (enabling only reverse rotation)			00		Not	Not	4-7
	b036	Reduced voltage start selection	0 (minimum reduced voltage start time) to 255 (maximum reduced voltage start time)			6		Not	Allowed	4-42
	b037	Function code display restriction	00 (full display), 01 (function-specific display), 02 (user setting), 03 (data comparison display), 04 (basic display)			04		Not	Allowed	4-76
	b038	Initial-screen selection	00 (screen displayed when the STR key was pressed last), 001~060 (d001~d060), 201 (F001) 202 *)			01		Not	Allowed	4-78
	b039	Automatic user-parameter setting function enable	00 (disabling), 01 (enabling)			00		Not	Allowed	4-79
Torque limitation	b040	Torque limit selection	00 (quadrant-specific setting), 01 (switching by terminal), 02 (analog input), 03 (option 1), 04 (option 2)			00		Not	Allowed	4-92
	b041	Torque limit (1) (forward-driving in 4-quadrant mode)	0. to 200. (%), no (disabling torque limitation) <0. to 150. (%), no (disabling torque limitation)> (In case of CT) 0. to 150. (%), no (disabling torque limitation)(In case of VT)			150.(CT) 120.(VT)		Not	Allowed	
	b042	Torque limit (2) (reverse-regenerating in 4-quadrant mode)				150.(CT) 120.(VT)		Not	Allowed	
	b043	Torque limit (3) (reverse-driving in 4-quadrant mode)				150.(CT) 120.(VT)		Not	Allowed	
	b044	Torque limit (4) (forward-regenerating in 4-quadrant mode)				150.(CT) 120.(VT)		Not	Allowed	
	b045	Torque limit LADSTOP enable				00 (disabling), 01 (enabling)			00	
b046	Reverse Run protection enable	00 (disabling), 01 (enabling)			00		Not	Allowed	4-93	
Mode	b049	Dual rating selection	00 (CT : Constant torque) 01 (VT : Variable torque)			00		Not	Not	3-22
Non-stop operation at momentary power failure	b050	Controller deceleration and stop on power loss	00 (disabling), 01 (nonstop deceleration to stop), 02 (DC voltage constant control, with resume), 03 (without resume)			00		Not	Not	4-83
	b051	DC bus voltage trigger level during power loss	0.0 to 999.9, 1000. (V)			220.0/440.0		Not	Not	
	b052	Over-voltage threshold during power loss	0.0 to 999.9, 1000. (V)			360.0/720.0		Not	Not	
	b053	Deceleration time setting during power loss	0.01 to 99.99, 100.0 to 999.9, 1000. to 3600. (s)			1.00		Not	Not	
	b054	Initial output frequency decrease during power loss	0.00 to 10.00 (Hz)			0.00		Not	Not	
	b055	Proportional gain setting for nonstop operation at power loss	0.00 to 2.55			0.20		Allowed	Allowed	
	b056	Integral time setting for nonstop operation at power loss	0.000 to 9.999 /10.00 to 65.53 (s)			0.100		Allowed	Allowed	
Window comparator	b060	Maximum-limit level of window comparators O	0. to 100. (lower limit : b061 + b062 x 2) (%)			100		Allowed	Allowed	4-71
	b061	Minimum-limit level of window comparators O	0. to 100. (upper limit : b060 - b062 x 2) (%)			0		Allowed	Allowed	
	b062	Hysteresis width of window comparators O	0. to 10. (upper limit : b060 - b061 / 2) (%)			0		Allowed	Allowed	
	b063	Maximum-limit level of window comparators OI	0. to 100. (lower limit : b064 + b065 x 2) (%)			100		Allowed	Allowed	
	b064	Minimum-limit level of window comparators OI	0. to 100. (upper limit : b063 - b065 x 2) (%)			0		Allowed	Allowed	
	b065	Hysteresis width of window comparators OI	0. to 10. (upper limit : b063 - b064 / 2) (%)			0		Allowed	Allowed	
	b066	Maximum-limit level of window comparators OI	-100. to 100. (lower limit : b067 + b068 x 2) (%)			100		Allowed	Allowed	
	b067	Minimum-limit level of window comparators O/OI/O2	-100. to 100. (upper limit : b066 - b068 x 2) (%)			0		Allowed	Allowed	
	b068	Hysteresis width of window comparators O/OI/O2	0. to 10. (upper limit : b066 - b067 / 2) (%)			0		Allowed	Allowed	
	b070	Operation level at O disconnection	0. to 100. (%) or "no" (ignore)			no		Not	Allowed	
	b071	Operation level at OI disconnection	0. to 100. (%) or "no" (ignore)			no		Not	Allowed	
b072	Operation level at O2 disconnection	-100. to 100. (%) or "no" (ignore)			no		Not	Allowed		

(Note) <> indicate the setting range of 75 to 150kW

(Note) CT : Constant torque mode, VT : variable torque mode, you can set CT or VT by b049.

*) In case of connecting OPE-S to the inverter, '201' setting is same as '00' setting. Refer to the SJ700D-3 instruction manual.

Code	Function name	Monitored data or setting	Default			Memo	Change during RUN operation		Page	
			FF	FEF	FUF		b031≠10	b031=10		
Others	b078	Cumulative input power data clearance	Clearance by setting "01" and pressing the STR key			00		Allowed	Allowed	4-4
	b079	Cumulative input power display gain setting	1. to 1000.			1.		Allowed	Allowed	
	b082	Start frequency adjustment	0.10 to 9.99 (Hz)			0.50		Not	Allowed	4-42
	b083	Carrier frequency setting	0.5~15.0(kHz) <0.5~10.0(kHz)> (In case of CT) 0.5~12.0(kHz) (In case of VT)			5.0<3.0>(CT) 3.0(VT)		Not	Not	4-43
	b084	Initialization mode (parameters or trip history)	00 (clearing the trip history), 01 (initializing the data), 02 (clearing the trip history and initializing the data)			00		Not	Not	4-75
	b085	Country code for initialization	00 (Japan), 01 (EU), 02 (U.S.A.)			00 01 02		Not	Not	
	b086	Frequency scaling conversion factor	0.1 to 99.0			1.0		Allowed	Allowed	4-2
	b087	STOP key enable	00 (enabling), 01 (disabling), 02 (disabling only the function to stop)			00		Not	Allowed	4-9
	b088	Restart mode after FRS	00 (starting with 0 Hz), 01 (starting with matching frequency), 02 (starting with active matching frequency)			00		Not	Allowed	4-52
	b089	Automatic carrier frequency reduction	00: invalid, 01: valid			00		Not	Not	4-44
	b090	Dynamic braking usage ratio	0.0 to 100.0 (%)			0.0		Not	Allowed	4-45
	b091	Stop mode selection	00 (deceleration until stop), 01 (free-run stop)			00		Not	Allowed	4-9
	b092	Cooling fan control	00 (always operating the fan), 01 (operating the fan only during inverter operation [including 5 minutes after power-on and power-off])			00		Not	Allowed	4-45
	b095	Dynamic braking control	00 (disabling), 01 (enabling [disabling while the motor is topped]), 02 (enabling [enabling also while the motor is topped])			00		Not	Allowed	
	b096	Dynamic braking activation level	330 to 380, 660 to 760(V)			360/720		Not	Allowed	
b098	Thermistor for thermal protection control	00 (disabling the thermistor), 01 (enabling the thermistor with PTC), 02 (enabling the thermistor with NTC)			00		Not	Allowed	4-72	
b099	Thermal protection level setting	0. to 9999. (Ω)			3000.		Not	Allowed		
Free setting of V/f characteristic	b100	Free-setting V/f frequency (1)	0. to "free-setting V/f frequency (2)" (Hz)			0.		Not	Not	4-17
	b101	Free-setting V/f voltage (1)	0.0 to 800.0 (V)			0.0		Not	Not	
	b102	Free-setting V/f frequency (2)	"free-setting V/f frequency (1)" to "free-setting V/f frequency (3)" (Hz)			0.		Not	Not	
	b103	Free-setting V/f voltage (2)	0.0 to 800.0 (V)			0.0		Not	Not	
	b104	Free-setting V/f frequency (3)	"free-setting V/f frequency (2)" to "free-setting V/f frequency (4)" (Hz)			0.		Not	Not	
	b105	Free-setting V/f voltage (3)	0.0 to 800.0 (V)			0.0		Not	Not	
	b106	Free-setting V/f frequency (4)	"free-setting V/f frequency (3)" to "free-setting V/f frequency (5)" (Hz)			0.		Not	Not	
	b107	Free-setting V/f voltage (4)	0.0 to 800.0 (V)			0.0		Not	Not	
	b108	Free-setting V/f frequency (5)	"free-setting V/f frequency (4)" to "free-setting V/f frequency (6)" (Hz)			0.		Not	Not	
	b109	Free-setting V/f voltage (5)	0.0 to 800.0 (V)			0.0		Not	Not	
	b110	Free-setting V/f frequency (6)	"free-setting V/f frequency (5)" to "free-setting V/f frequency (7)" (Hz)			0.		Not	Not	
	b111	Free-setting V/f voltage (6)	0.0 to 800.0 (V)			0.0		Not	Not	
	b112	Free-setting V/f frequency (7)	"free-setting V/f frequency (6)" (Hz) to 400. (Hz)			0.		Not	Not	
b113	Free-setting V/f voltage (7)	0.0 to 800.0 (V)			0.0		Not	Not		
Others	b120	Brake Control Enable	00 (disabling), 01 (enabling)			00		Not	Allowed	4-81
	b121	Brake Wait Time for Release	0.00 to 5.00 (s)			0.00		Not	Allowed	
	b122	Brake Wait Time for Acceleration				0.00		Not	Allowed	
	b123	Brake Wait Time for Stopping				0.00		Not	Allowed	
	b124	Brake Wait Time for Confirmation				0.00		Not	Allowed	
	b125	Brake Release Frequency Setting	0.00 to 99.99, 100.0 to 400.0 (Hz)			0.00		Not	Allowed	
	b126	Brake Release Current Setting	0.0 to 2.00 x "rated current" <0.0 to 1.80 x "rated current">			Rated current		Not	Allowed	
	b127	Braking frequency	0.00 to 99.99, 100.0 to 400.0 (Hz)			0.00		Not	Allowed	
Overvoltage suppression	b130	Overvoltage suppression enable	00 (disabling the restraint), 01 (controlled deceleration), 02 (enabling acceleration), . 03 (enabling acceleration)			00		Not	Allowed	4-41
	b131	Overvoltage suppression level	330 to 390 (V) (200 V class model), 660 to 780 (V) (400 V class model)			380/760		Not	Allowed	
	b132	Acceleration and deceleration rate at overvoltage suppression	0.10 to 30.00 (s)			1.00		Not	Allowed	
	b133	Overvoltage suppression propotional gain	0.00 to 2.55			0.50		Allowed	Allowed	
	b134	Overvoltage suppression Integral time	0.000 to 9.999 / 10.00 to 65.53 (s)			0.060		Allowed	Allowed	
Others	b141	Output loss detection enable	00 (disabling), 01 (enabling)			00		Not	Allowed	4-36
	b142	Output loss detection sensibility	1~100.(%)			10.		Allowed	Allowed	
	b164	Automatic return to initial display	00 (disabling), 01 (enabling)			00		Allowed	Allowed	4-78
	b166	Data Read/Write select	00 (Read/Write OK), 01 (Protected)			00		Not	Allowed	4-95
	b180	Initialization trigger	00 (Initialization disable), 01 (Perform initialization)			00		Not	Not	4-75

(Note)<>indicate the setting range of 75 to 150kW

Code	Function name	Monitored data or setting	Default			Memo	Change during RUN operation		Page		
			FF	FEF	FUF		b031≠10	b031=10			
Intelligent input terminals	C001	Terminal [1] function (*2)	01 (RV: Reverse RUN), 02 (CF1: Multispeed 1 setting), 03 (CF2: Multispeed 2 setting), 04 (CF3: Multispeed 3 setting), 05 (CF4: Multispeed 4 setting), 06 (JG: Jogging), 07 (DB: external DC braking), 08 (SET: Set 2nd motor data), 09 (2CH: 2-stage acceleration/deceleration), 11 (FRS: free-run stop), 12 (EXT: external trip), 13 (USP: unattended start protection), 14 (CS: commercial power source enable), 15 (SFT: software lock), 16 (AT: analog input voltage/current select), 17 (SET3: 3rd motor control), 18 (RS: reset), 20 (STA: starting by 3-wire input), 21 (STP: stopping by 3-wire input), 22 (F/R: forward/reverse switching by 3-wire input), 23 (PID: PID disable), 24 (PIDC: PID reset), 26 (CAS: control gain setting), 27 (UP: remote control UP function), 28 (DWN: remote control DOWN function), 29 (DWN: remote control data clearing), 31 (OPE: forcible operation), 32 (SF1: multispeed bit 1), 33 (SF2: multispeed bit 2), 34 (SF3: multispeed bit 3), 35 (SF4: multispeed bit 4), 36 (SF5: multispeed bit 5), 37 (SF6: multispeed bit 6), 38 (SF7: multispeed bit 7), 39 (OLR: overload restriction selection), 40 (TL: torque limit enable), 41 (TRQ1: torque limit selection bit 1), 42 (TRQ2: torque limit selection bit 2), 43 (PPI: P/PI mode selection), 44(BOK:braking confirmation), 46 (LAC: LAD cancellation), 47(PCLR:clearance of position deviation) 48(STAT:pulse train position command input enable) 50 (ADD: trigger for frequency addition [A145]), 51 (F-TM: forcible-terminal operation), 52(ATR:permission of torque command input), 53 (KHC: cumulative power clearance), 54(SON:servo-on), 55(FOC:pre-excitation), 56 (MI1: general-purpose input 1), 57 (MI2: general-purpose input 2), 58 (MI3: general-purpose input 3), 59 (MI4: general-purpose input 4), 60 (MI5: general-purpose input 5), 61 (MI6: general-purpose input 6), 62 (MI7: general-purpose input 7), 63 (MI8: general-purpose input 8), 64(EMR: Emergency stop signal), 65 (AHD: analog command holding), 66(CP1:multi stage position settings selection 1), 67(CP2:multi stage position settings selection 2), 68(CP3:multi stage position settings selection 3), 69(ORL:Zero-return limit function), 70(ORG:Zero-return trigger function), 71(FOT:forward drive stop),72(ROT:reverde drive stop), 73(SPD:speed/position switching), 74 (PCNT: pulse counter), 75 (PCC: pulse counter clear), 82(PRG:EzSQ program-run terminal), no (NO: no assignment)			18 (*2)			Not	Allowed	4-46
	C002	Terminal [2] function	16					Not	Allowed		
	C003	Terminal [3] function (*2)	06 (*2)					Not	Allowed		
	C004	Terminal [4] function	11					Not	Allowed		
	C005	Terminal [5] function	09					Not	Allowed		
	C006	Terminal [6] function	03 03 13					Not	Allowed		
	C007	Terminal [7] function	02					Not	Allowed		
	C008	Terminal [8] function	01					Not	Allowed		
C011	Terminal [1] active state	00 (NO) / 01 (NC)			00			Not	Allowed	4-47	
C012	Terminal [2] active state	00 (NO) / 01 (NC)			00			Not	Allowed		
C013	Terminal [3] active state	00 (NO) / 01 (NC)			00			Not	Allowed		
C014	Terminal [4] active state	00 (NO) / 01 (NC)			00			Not	Allowed		
C015	Terminal [5] active state	00 (NO) / 01 (NC)			00			Not	Allowed		
C016	Terminal [6] active state	00 (NO) / 01 (NC)			00			Not	Allowed		
C017	Terminal [7] active state	00 (NO) / 01 (NC)			00			Not	Allowed		
C018	Terminal [8] active state	00 (NO) / 01 (NC)			00			Not	Allowed		
C019	Terminal [FW] active state	00 (NO) / 01 (NC)			00			Not	Allowed		

*2 When the emergency stop function is enabled (SW1 = ON), "18" (RS) and "64" (EMR) are forcibly written to parameters "C001" and "C003", respectively. (You cannot arbitrarily write "64" to "C001".) If the SW1 signal is turned off and then turned on, "no" (no assignment) is set in parameter "C003".

Code	Function name	Monitored data or setting	Default			Memo	Change during RUN operation		Page			
			FF	FEF	FUF		b031≠10	b031=10				
Intelligent output terminals	C021	Terminal [11] function	00 (RUN: running), 01 (FA1: constant-speed reached), 02 (FA2: set frequency overreached), 03 (OL: overload notice advance signal (1)), 04 (OD: output deviation for PID control), 05 (AL: alarm signal), 06 (FA3: set frequency reached), 07 (OTQ: over-torque), 08 (IP: instantaneous power failure), 09 (UV: under voltage), 10 (TRQ: torque limited), 11 (RNT: operation time over), 12 (ONT: plug-in time over), 13 (THM: thermal alarm signal), 19(BRK:brakge release), 20(BER:braking error)21 (ZS: 0 Hz detection signal), 22(DSE:speed deviation maximum), 23(POK:positioning completed), 24 (FA4: set frequency overreached 2), 25 (FA5: set frequency reached 2), 26 (OL2: overload notice advance signal (2)), 27 (Odc: Analog O disconnection detection), 28 (OIdc: Analog OI disconnection detection), 29 (O2Dc: Analog O2 disconnection detection), 31 (FBV: PID feedback comparison), 32 (NDC: communication line disconnection), 33 (LOG1: logical operation result 1), 34 (LOG2: logical operation result 2), 35 (LOG3: logical operation result 3), 36 (LOG4: logical operation result 4), 37 (LOG5: logical operation result 5), 38 (LOG6: logical operation result 6), 39 (WAC: capacitor life warning), 40 (WAF: cooling-fan speed drop), 41 (FR: starting contact signal), 42 (OHF: heat sink overheat warning), 43 (LOC: low-current indication signal), 44 (M01: general-purpose output 1), 45 (M02: general-purpose output 2), 46 (M03: general-purpose output 3), 47 (M04: general-purpose output 4), 48 (M05: general-purpose output 5), 49 (M06: general-purpose output 6), 50 (IRDY: inverter ready), 51 (FWR: forward rotation), 52 (RVR: reverse rotation), 53 (MJA: major failure), 54(WCO: window comparator O), 55(WCOI: window comparator OI), 56 (WCO2: window comparator O2) (When alarm code output is selected for "C062", functions "AC0" to "AC2" or "AC0" to "AC3" [ACn: alarm code output] are forcibly assigned to intelligent output terminals 11 to 13 or 11 to 14, respectively.)			01				Not	Allowed	4-60
	C022	Terminal [12] function	00				Not	Allowed				
	C023	Terminal [13] function	03				Not	Allowed				
	C024	Terminal [14] function	07				Not	Allowed				
	C025	Terminal [15] function	40				Not	Allowed				
	C026	Alarm relay terminal function	05				Not	Allowed				
Analog monitoring	C027	[FM] signal selection	00 (output frequency), 01 (output current), 02 (output torque), 03 (digital output frequency), 04 (output voltage), 05 (input power), 06 (electronic thermal overload), 07 (LAD frequency), 08 (digital current monitoring), 09 (motor temperature), 10 (heat sink temperature), 12 (general-purpose output YA0), 19(Option1), 20(Option2)			00			Not	Allowed	4-73	
	C028	[AM] signal selection	00 (output frequency), 01 (output current), 02 (output torque), 04 (output voltage), 05 (input power), 06 (electronic thermal overload), 07 (LAD frequency), 09 (motor temperature), 10 (heat sink temperature), 11 (output torque [signed value]), 13 (general-purpose output YA1), 19(Option1), 20(Option2)			00			Not	Allowed	4-74	
	C029	[AMI] signal selection	00 (output frequency), 01 (output current), 02 (output torque), 04 (output voltage), 05 (input power), 06 (electronic thermal overload), 07 (LAD frequency), 09 (motor temperature), 10 (heat sink temperature), 14 (general-purpose output YA2),19(Option1), 20(Option2)			00			Not	Allowed		
	C030	Digital current monitor reference value	0.20 x "rated current" to 2.00 x "rated current" (A) (Current with digital current monitor output at 1,440 Hz)			Rated current			Allowed	Allowed	4-73	
Intelligent output terminals	C031	Terminal [11] active state	00 (NO) / 01 (NC)			00			Not	Allowed	4-61	
	C032	Terminal [12] active state	00 (NO) / 01 (NC)			00			Not	Allowed		
	C033	Terminal [13] active state	00 (NO) / 01 (NC)			00			Not	Allowed		
	C034	Terminal [14] active state	00 (NO) / 01 (NC)			00			Not	Allowed		
	C035	Terminal [15] active state	00 (NO) / 01 (NC)			00			Not	Allowed		
	C036	Alarm relay active state	00 (NO) / 01 (NC)			01			Not	Allowed		

Code	Function name	Monitored data or setting	Default			Memo	Change during RUN operation		Page	
			FF	FEF	FUF		b031≠10	b031=10		
Levels and output terminal status	C038	Low-current indication signal output mode selection	00 (output during acceleration/deceleration and constant-speed operation), 01 (output only during constant-speed operation)			01		Not	Allowed	4-69
	C039	Low-current indication signal detection level	0.00 to 2.00 x "rated current" (A) <0.00 to 1.80 x "rated current" (A) > (In case of CT) 0.00 to 1.50 x "rated current" (A) (In case of VT)			Rated current		Allowed	Allowed	
	C040	Overload signal output mode	00 (output during acceleration/deceleration and constant-speed operation), 01 (output only during constant-speed operation)			01		Not	Allowed	4-40
	C041	Overload level setting	0.00 to 2.00 x "rated current" (A) <0.00 to 1.80 x "rated current" (A) > (In case of CT) 0.00 to 1.50 x "rated current" (A) (In case of VT)			Rated current		Allowed	Allowed	
	C042	Frequency arrival setting for accel.	0.00 to 99.99, 100.0 to 400.0 (Hz)			0.00		Not	Allowed	4-62
	C043	Frequency arrival setting for decel.	0.00 to 99.99, 100.0 to 400.0 (Hz)			0.00		Not	Allowed	
	C044	PID deviation level setting	0.0 to 100.0 (%)			3.0		Not	Allowed	4-29
	C045	Frequency arrival setting for acceleration (2)	0.00 to 99.99, 100.0 to 400.0 (Hz)			0.00		Not	Allowed	4-62
	C046	Frequency arrival setting for deceleration (2)	0.00 to 99.99, 100.0 to 400.0 (Hz)			0.00		Not	Allowed	
	C052	Maximum PID feedback data	0.0 to 100.0 (%)			100.0		Not	Allowed	4-29
	C053	Minimum PID feedback data	0.0 to 100.0 (%)			0.0		Not	Allowed	
	C055	Over-torque (forward-driving) level setting	0. to 200. (%) <0. to 180. (%)>			100.		Not	Allowed	4-65
	C056	Over-torque (reverse regenerating) level setting	0. to 200. (%) <0. to 180. (%)>			100.		Not	Allowed	
	C057	Over-torque (reverse driving) level setting	0. to 200. (%) <0. to 180. (%)>			100.		Not	Allowed	
	C058	Over-torque (forward regenerating) level setting	0. to 200. (%) <0. to 180. (%)>			100.		Not	Allowed	
	C061	Electronic thermal warning level setting	0. to 100. (%)			80.		Not	Allowed	4-38
C062	Alarm code output	00 (disabling), 01 (3 bits), 02 (4 bits)			00		Not	Allowed	4-65	
C063	Zero speed detection level	0.00 to 99.99, 100.0 (Hz)			0.00		Not	Allowed	4-64	
C064	Heat sink overheat warning level	0. to 200.0 (°C)			120.		Not	Allowed	4-68	
Communication function	C071	Communication speed selection	02 (loopback test), 03(2400bps), 04(4800bps), 05(9600bps), 06(19.2kbps), 07(38.4kbps), 08(57.6kbps), 09(76.8kbps), 10(115.2kbps)			04		Not	Allowed	4-11 3
	C072	Node allocation	1. to 32.			1.		Not	Allowed	
	C073	Communication data length selection	7 (7 bits), 8 (8 bits)			7		Not	Allowed	
	C074	Communication parity selection	00 (no parity), 01 (even parity), 02 (odd parity)			00		Not	Allowed	
	C075	Communication stop bit selection	1 (1 bit), 2 (2 bits)			1		Not	Allowed	
	C076	Selection of the operation after communication error	00 (tripping), 01 (tripping after decelerating and stopping the motor), 02 (ignoring errors), 03 (stopping the motor after free-running), 04 (decelerating and stopping the motor)			02		Not	Allowed	
	C077	Communication timeout limit before tripping	0.00 to 99.99 (s)			0.00		Not	Allowed	
	C078	Communication wait time	0. to 1000. (ms)			0.		Not	Allowed	
C079	Communication mode selection	00(ASCII), 01(Modbus-RTU)			00		Not	Allowed		
Adjustment	C081	[O] input span calibration				Factory setting		Allowed	Allowed	4-72
	C082	[O1] input span calibration	0. to 9999., 1000 to 6553(10000 to 65530)			Factory setting		Allowed	Allowed	
	C083	[O2] input span calibration				Factory setting		Allowed	Allowed	
	C085	Thermistor input tuning	0.0 to 999.9, 1000.			Factory setting		Allowed	Allowed	
C091	Debug mode enable	(Do not change this parameter, which is intended for factory adjustment.)			00		Not	Not	–	
Others	C101	Up/Down memory mode selection	00 (not storing the frequency data), 01 (storing the frequency data)			00		Not	Allowed	4-56
	C102	Reset mode selection	00 (resetting the trip when RS is on), 01 (resetting the trip when RS is off), 02 (enabling resetting only upon tripping [resetting when RS is on]), 03(resetting only trip)			00		Allowed	Allowed	4-54
	C103	Restart mode after reset	00 (starting with 0 Hz), 01 (starting with matching frequency), 02 (restarting with active matching frequency)			00		Not	Allowed	
Meter adjustment	C105	FM gain adjustment				100.		Allowed	Allowed	4-74
	C106	AM gain adjustment	50. to 200. (%)			100.		Allowed	Allowed	
	C107	AMI gain adjustment				100.		Allowed	Allowed	
	C109	AM bias adjustment	0. to 100. (%)			0.		Allowed	Allowed	
	C110	AMI bias adjustment				20.		Allowed	Allowed	

(Note) < > indicate the setting range of 75 to 150kW

(Note) CT : Constant torque mode, VT : variable torque mode, you can set CT or VT by b049.

Code	Function name	Monitored data or setting	Default			Memo	Change during RUN operation		Page	
			FF	FEF	FUF		b031≠10	b031=10		
Terminal	C111	Overload setting (2)	0.20 to 2.00 x "rated current" (A) <0.20 to 1.80 x "rated current" (A) > (In case of CT) 0.20 to 1.50 x "rated current" (A) (In case of VT)			Rated current		Allowed	Allowed	4-40
Adjustment	C121	[O] input zero calibration	0. to 9999., 1000 to 6553 (10000 to 65530)			Factory setting		Allowed	Allowed	-
	C122	[O1] input zero calibration				Factory setting		Allowed	Allowed	
	C123	[O2] input zero calibration				Factory setting		Allowed	Allowed	
Output terminal operation function	C130	Output 11 on-delay time	0.0 to 100.0 (s)			0.0		Not	Allowed	4-72
	C131	Output 11 off-delay time				0.0		Not	Allowed	
	C132	Output 12 on-delay time	0.0 to 100.0 (s)			0.0		Not	Allowed	
	C133	Output 12 off-delay time				0.0		Not	Allowed	
	C134	Output 13 on-delay time	0.0 to 100.0 (s)			0.0		Not	Allowed	
	C135	Output 13 off-delay time				0.0		Not	Allowed	
	C136	Output 14 on-delay time	0.0 to 100.0 (s)			0.0		Not	Allowed	
	C137	Output 14 off-delay time				0.0		Not	Allowed	
	C138	Output 15 on-delay time	0.0 to 100.0 (s)			0.0		Not	Allowed	
	C139	Output 15 off-delay time				0.0		Not	Allowed	
	C140	Output RY on-delay time	0.0 to 100.0 (s)			0.0		Not	Allowed	
	C141	Output RY off-delay time				0.0		Not	Allowed	
	C142	Logical output signal 1 selection 1	Same as the settings of C021 to C026 (except those of LOG1 to LOG6)			00		Not	Allowed	
	C143	Logical output signal 1 selection 2				00		Not	Allowed	
	C144	Logical output signal 1 operator selection	00 (AND), 01 (OR), 02 (XOR)			00		Not	Allowed	
	C145	Logical output signal 2 selection 1	Same as the settings of C021 to C026 (except those of LOG1 to LOG6)			00		Not	Allowed	
	C146	Logical output signal 2 selection 2				00		Not	Allowed	
	C147	Logical output signal 2 operator selection	00 (AND), 01 (OR), 02 (XOR)			00		Not	Allowed	
	C148	Logical output signal 3 selection 1	Same as the settings of C021 to C026 (except those of LOG1 to LOG6)			00		Not	Allowed	
	C149	Logical output signal 3 selection 2				00		Not	Allowed	
	C150	Logical output signal 3 operator selection	00 (AND), 01 (OR), 02 (XOR)			00		Not	Allowed	
C151	Logical output signal 4 selection 1	Same as the settings of C021 to C026 (except those of LOG1 to LOG6)			00		Not	Allowed		
C152	Logical output signal 4 selection 2				00		Not	Allowed		
C153	Logical output signal 4 operator selection	00 (AND), 01 (OR), 02 (XOR)			00		Not	Allowed		
C154	Logical output signal 5 selection 1	Same as the settings of C021 to C026 (except those of LOG1 to LOG6)			00		Not	Allowed		
C155	Logical output signal 5 selection 2				00		Not	Allowed		
C156	Logical output signal 5 operator selection	00 (AND), 01 (OR), 02 (XOR)			00		Not	Allowed		
C157	Logical output signal 6 selection 1	Same as the settings of C021 to C026 (except those of LOG1 to LOG6)			00		Not	Allowed		
C158	Logical output signal 6 selection 2				00		Not	Allowed		
C159	Logical output signal 6 operator selection	00 (AND), 01 (OR), 02 (XOR)			00		Not	Allowed		
Input terminal response	C160	Input terminal response time setting 1	0. to 200. (× 2ms)			1		Not	Allowed	4-72
	C161	Input terminal response time setting 2	0. to 200. (× 2ms)			1		Not	Allowed	
	C162	Input terminal response time setting 3	0. to 200. (× 2ms)			1		Not	Allowed	
	C163	Input terminal response time setting 4	0. to 200. (× 2ms)			1		Not	Allowed	
	C164	Input terminal response time setting 5	0. to 200. (× 2ms)			1		Not	Allowed	
	C165	Input terminal response time setting 6	0. to 200. (× 2ms)			1		Not	Allowed	
	C166	Input terminal response time setting 7	0. to 200. (× 2ms)			1		Not	Allowed	
	C167	Input terminal response time setting 8	0. to 200. (× 2ms)			1		Not	Allowed	
	C168	Input terminal response time setting FW	0. to 200. (× 2ms)			1		Not	Allowed	
Other	C169	Multistage speed/position determination time	0. to 200. (× 10ms)			0		Not	Allowed	4-48 4-108

(Note)<>indicate the setting range of 75 to 150kW

Code	Function name	Monitored data or setting	Default			Memo	Change during RUN operation		Page	
			FF	FEF	FUF		b031≠10	b031=10		
Control constants	H001	Auto-tuning Setting	00 (disabling auto-tuning), 01 (auto-tuning without rotation), 02 (auto-tuning with rotation)			00		Not	Not	4-85
	H002	Motor data selection, 1st motor	00 (Hitachi standard data), 01 (auto-tuned data), 02 (auto-tuned data [with online auto-tuning function])			00		Not	Not	
	H202	Motor data selection, 2nd motor				00		Not	Not	
	H003	Motor capacity, 1st motor	0.20 to 75.00 (kW) <0.20 to 160. (kW) >			Factory setting		Not	Not	
	H203	Motor capacity, 2nd motor				Factory setting		Not	Not	
	H004	Motor poles setting, 1st motor	2, 4, 6, 8, 10 (poles)			4		Not	Not	
	H204	Motor poles setting, 2nd motor				4		Not	Not	
	H005	Motor speed constant, 1st motor	0.001 to 9.999, 10.00 to 80.00 (10.000 to 80.000)			1.590		Allowed	Allowed	4-89
	H205	Motor speed constant, 2nd motor				1.590		Allowed	Allowed	
	H006	Motor stabilization constant, 1st motor	0. to 255.			100.		Allowed	Allowed	4-79
	H206	Motor stabilization constant, 2nd motor				100.		Allowed	Allowed	
	H306	Motor stabilization constant, 3rd motor				100.		Allowed	Allowed	
	H020	Motor constant R1, 1st motor	0.001 to 9.999, 10.00 to 65.53 (Ω)			Factory setting		Not	Not	4-88
	H220	Motor constant R1, 2nd motor				Factory setting		Not	Not	
	H221	Motor constant R2, 1st motor	0.001 to 9.999, 10.00 to 65.53 (Ω)			Factory setting		Not	Not	
	H221	Motor constant R2, 2nd motor				Factory setting		Not	Not	
	H222	Motor constant L, 1st motor	0.01 to 99.99, 100.0 to 655.3 (mH)			Factory setting		Not	Not	
	H222	Motor constant L, 2nd motor				Factory setting		Not	Not	
	H223	Motor constant lo	0.01 to 99.99, 100.0 to 655.3 (A)			Factory setting		Not	Not	
	H223	Motor constant lo, 2nd motor				Factory setting		Not	Not	
	H224	Motor constant J	0.001 to 9.999, 10.00 to 99.99, 100.0 to 999.9, 1000. to 9999			Factory setting		Not	Not	
	H224	Motor constant J, 2nd motor				Factory setting		Not	Not	
	H030	Auto constant R1, 1st motor	0.001 to 9.999, 10.00 to 65.53 (Ω)			Factory setting		Not	Not	4-85
	H230	Auto constant R1, 2nd motor				Factory setting		Not	Not	
	H231	Auto constant R2, 1st motor	0.001 to 9.999, 10.00 to 65.53 (Ω)			Factory setting		Not	Not	
	H231	Auto constant R2, 2nd motor				Factory setting		Not	Not	
	H232	Auto constant L, 1st motor	0.01 to 99.99, 100.0 to 655.3 (mH)			Factory setting		Not	Not	
	H232	Auto constant L, 2nd motor				Factory setting		Not	Not	
	H233	Auto constant lo, 1st motor	0.01 to 99.99, 100.0 to 655.3 (A)			Factory setting		Not	Not	
	H233	Auto constant lo, 2nd motor				Factory setting		Not	Not	
	H234	Auto constant J, 1st motor	0.001 to 9.999, 10.00 to 99.99, 100.0 to 999.9, 1000. to 9999.			Factory setting		Not	Not	
	H234	Auto constant J, 2nd motor				Factory setting		Not	Not	
	H050	PI proportional gain for 1st motor	0.0 to 999.9, 1000.			100.0		Allowed	Allowed	4-58
	H250	PI proportional gain for 2nd motor				100.0		Allowed	Allowed	
	H051	PI integral gain for 1st motor	0.0 to 999.9, 1000.			100.0		Allowed	Allowed	
	H251	PI integral gain for 2nd motor				100.0		Allowed	Allowed	
H052	P proportional gain setting for 1st motor	0.01 to 10.00			1.00		Allowed	Allowed		
H252	P proportional gain setting for 2nd motor				1.00		Allowed	Allowed		
H060	Zero LV limit for 1st motor	0.0 to 100.0			100.0		Allowed	Allowed	4-90	
H260	Zero LV limit for 2nd motor				100.0		Allowed	Allowed		
H061	Zero LV starting boost current for 1st motor	0. to 50. (%)			50.		Allowed	Allowed		
H261	Zero LV starting boost current for 2nd motor				50.		Allowed	Allowed		
H070	Terminal selection PI proportional gain setting	0.0 to 999.9, 1000.			100.0		Allowed	Allowed	4-58	
H071	Terminal selection PI integral gain setting				100.0		Allowed	Allowed		
H072	Terminal selection P proportional gain setting				1.00		Allowed	Allowed		
H073	Gain switching time	0. to 9999. (ms)			100.		Allowed	Allowed		

(Note)<>indicate the setting range of 75 to 150kW

Code	Function name	Monitored data or setting	Default			Memo	Change during RUN operation		Page
			FF	FEF	FUF		b031≠10	b031=10	
P001	Operation mode on expansion card 1 error	00 (tripping), 01 (continuing operation)	00				Not	Allowed	4-79
P002	Operation mode on expansion card 2 error	00 (tripping), 01 (continuing operation)	00				Not	Allowed	
P011	Encoder pulse-per-revolution (PPR) setting	128. to 9999., 1000 to 6553(10000 to 65535) (pulses)	1024.				Not	Not	4-96
P012	Control pulse setting	00 (ASR), 01 (APR), 02 (APR2), 03 (HAPR)	00				Not	Not	4-96
P013	Pulse train mode setting	00 (mode 0), 01 (mode 1), 02 (mode 2)	00				Not	Not	4-99
P014	Home search stop position setting	0. to 4095.	0.				Not	Allowed	4-104
P015	Home search speed setting	"start frequency" to "maximum frequency" (up to 120.0) (Hz)	5.00				Not	Allowed	
P016	Home search direction setting	00 (forward), 01 (reverse)	00				Not	Not	
P017	Home search completion range setting	0. to 9999., 1000 (10000) (pulses)	5.				Not	Allowed	4-99
P018	Home search completion delay time setting	0.00 to 9.99 (s)	0.00				Not	Allowed	4-99
P019	Electronic gear set position selection	00 (feedback side), 01 (commanding side)	00				Not	Allowed	4-101
P020	Electronic gear ratio numerator setting	0. to 9999.	1.				Allowed	Allowed	
P021	Electronic gear ratio denominator setting	0. to 9999.	1.				Allowed	Allowed	
P022	Feed-forward gain setting	0.00 to 99.99, 100.0 to 655.3	0.00				Allowed	Allowed	4-101
P023	Position loop gain setting	0.00 to 99.99, 100.0	0.50				Allowed	Allowed	4-103
P024	Position bias setting	-204 (-2048.) / -999. to 2048.	0.				Allowed	Allowed	
P025	Temperature compensation thermistor enable	00 (no compensation), 01 (compensation)	00				Not	Allowed	4-87
P026	Over-speed error detection level setting	0.0 to 150.0 (%)	135.0				Not	Allowed	5-5
P027	Speed deviation error detection level setting	0.00 to 99.99, 100.0 to 120.0 (Hz)	7.50				Not	Not	4-96
P028	Numerator of motor gear ratio	0. to 9999.	1.				Not	Allowed	4-103
P029	Denominator of motor gear ratio	0. to 9999.	1.				Not	Allowed	
P031	Accel/decel time input selection	00 (digital operator), 01 (option 1), 02 (option 2), 03 (easy sequence)	00				Not	Not	4-10
P032	Positioning command input selection	00 (digital operator), 01 (option 1), 02 (option 2)	00				Not	Allowed	-
P033	Torque command input selection	00 (O terminal), 01 (OI terminal), 02 (O2 terminal), 03 (digital operator)	00				Not	Not	4-98
P034	Torque command setting	0. to 200. (%) <0. to 180. (%)>	0.				Allowed	Allowed	
P035	Polarity selection at the torque command input via O2 terminal	00 (as indicated by the sign), 01 (depending on the operation direction)	00				Not	Not	
P036	Torque bias mode	00 (disabling the mode), 01 (digital operator), 02 (input via O2 terminal)	00				Not	Not	4-98
P037	Torque bias value	-200. to +200. (%) <0. to 180. (%)>	0.				Allowed	Allowed	
P038	Torque bias polarity selection	00 (as indicated by the sign), 01 (depending on the operation direction)	00				Not	Not	
P039	Speed limit for torque-controlled operation (forward rotation)	0.00 to "maximum frequency" (Hz)	0.00				Allowed	Allowed	-
P040	Speed limit for torque-controlled operation (reverse rotation)	0.00 to "maximum frequency" (Hz)	0.00				Allowed	Allowed	
P044	DeviceNet comm watchdog timer	0.00 to 99.99 (s)	1.00				Not	Not	-
P045	Inverter action on DeviceNet comm error	00(tripping), 01(tripping after decelerating and stopping the motor), 02 (ignoring errors), 03 (stopping the motor after free-running), 04 (decelerating and stopping the motor)	01				Not	Not	
P046	DeviceNet polled I/O: Output instance number	20, 21, 100	21				Not	Not	
P047	DeviceNet polled I/O: Input instance number	70, 71, 101	71				Not	Not	
P048	Inverter action on DeviceNet idle mode	00 (tripping), 01 (tripping after decelerating and stopping the motor), 02 (ignoring errors), 03 (stopping the motor after free-running), 04 (decelerating and stopping the motor)	01				Not	Not	
P049	DeviceNet motor poles setting for RPM	0, 2, 4, 6, 8, 10, 12, 14, 16, 18, 20, 22, 24, 26, 28, 30, 32, 34, 36, 38 (poles)	0				Not	Not	

(Note)<>indicate the setting range of 75 to 150kW

Code	Function name	Monitored data or setting	Default			Memo	Change during RUN operation		Page	
			FF	FEF	FUF		b031≠10	b031=10		
Pulse control	P055	Pulse-string frequency scale	1.0 to 50.0 (kHz)			25.0		Not	Allowed	4-112
	P056	Time constant of pulse-string frequency filter	0.01 to 2.00 (s)			0.10		Not	Allowed	
	P057	Pulse-string frequency bias	-100. to +100. (%)			0.		Not	Allowed	
	P058	Pulse-string frequency limit	0. to 100. (%)			100.		Not	Allowed	
Absolute position control	P060	Multistage position setting 0	Position setting range reverse side to forward side (upper 4 digits including "-")			0		Allowed	Allowed	4-106
	P061	Multistage position setting 1	Position setting range reverse side to forward side (upper 4 digits including "-")			0		Allowed	Allowed	
	P062	Multistage position setting 2	Position setting range reverse side to forward side (upper 4 digits including "-")			0		Allowed	Allowed	
	P063	Multistage position setting 3	Position setting range reverse side to forward side (upper 4 digits including "-")			0		Allowed	Allowed	
	P064	Multistage position setting 4	Position setting range reverse side to forward side (upper 4 digits including "-")			0		Allowed	Allowed	
	P065	Multistage position setting 5	Position setting range reverse side to forward side (upper 4 digits including "-")			0		Allowed	Allowed	
	P066	Multistage position setting 6	Position setting range reverse side to forward side (upper 4 digits including "-")			0		Allowed	Allowed	
	P067	Multistage position setting 7	Position setting range reverse side to forward side (upper 4 digits including "-")			0		Allowed	Allowed	
	P068	Zero-return mode selection	00(Low) / 01 (Hi1) / 00 (Hi2)			00		Allowed	Allowed	
	P069	Zero-return direction selection	00 (FW) / 01 (RV)			00		Allowed	Allowed	
	P070	Low-speed zero-return frequency	0.00 to 10.00 (Hz)			0.00		Allowed	Allowed	
	P071	High-speed zero-return frequency	0.00 to 99.99 / 100.0 to Maximum frequency setting, 1 st motor (Hz)			0.00		Allowed	Allowed	
	P072	Position range specification (forward)	0 to 268435455 (when P012 = 02) 0 to 1073741823 (when P012 = 03) (upper 4 digits)			2684 (268435455)		Allowed	Allowed	
	P073	Position range specification (reverse)	-268435455 to 0 (when P012 = 02) -1073741823 to 0 (when P012 = 03) (upper 4 digits)			-268 (-268435455)		Allowed	Allowed	
P074	Teaching selection	00 (X00) / 01 (X01) / 02 (X02) / 03 (X03) / 04 (X04) / 05 (X05) / 06 (X06) / 07 (X07) /			00		Allowed	Allowed		
Easy sequence function	P100	Easy sequence user parameter U (00)	0. to 9999., 1000 to 6553 (10000 to 65535)			0.		Allowed	Allowed	4-95
	P101	Easy sequence user parameter U (01)	0. to 9999., 1000 to 6553 (10000 to 65535)			0.		Allowed	Allowed	
	P102	Easy sequence user parameter U (02)	0. to 9999., 1000 to 6553 (10000 to 65535)			0.		Allowed	Allowed	
	P103	Easy sequence user parameter U (03)	0. to 9999., 1000 to 6553 (10000 to 65535)			0.		Allowed	Allowed	
	P104	Easy sequence user parameter U (04)	0. to 9999., 1000 to 6553 (10000 to 65535)			0.		Allowed	Allowed	
	P105	Easy sequence user parameter U (05)	0. to 9999., 1000 to 6553 (10000 to 65535)			0.		Allowed	Allowed	
	P106	Easy sequence user parameter U (06)	0. to 9999., 1000 to 6553 (10000 to 65535)			0.		Allowed	Allowed	
	P107	Easy sequence user parameter U (07)	0. to 9999., 1000 to 6553 (10000 to 65535)			0.		Allowed	Allowed	
	P108	Easy sequence user parameter U (08)	0. to 9999., 1000 to 6553 (10000 to 65535)			0.		Allowed	Allowed	
	P109	Easy sequence user parameter U (09)	0. to 9999., 1000 to 6553 (10000 to 65535)			0.		Allowed	Allowed	
	P110	Easy sequence user parameter U (10)	0. to 9999., 1000 to 6553 (10000 to 65535)			0.		Allowed	Allowed	

(Note) < > indicate the setting range of 75 to 150kW

Code	Function name	Monitored data or setting	Default			Memo	Change during RUN operation		Page	
			FF	FEF	FUF		b031≠10	b031=10		
Easy sequence function	P111	Easy sequence user parameter U (11)	0. to 9999., 1000 to 6553 (10000 to 65535)			0.		Allowed	Allowed	4-95
	P112	Easy sequence user parameter U (12)	0. to 9999., 1000 to 6553 (10000 to 65535)			0.		Allowed	Allowed	
	P113	Easy sequence user parameter U (13)	0. to 9999., 1000 to 6553 (10000 to 65535)			0.		Allowed	Allowed	
	P114	Easy sequence user parameter U (14)	0. to 9999., 1000 to 6553 (10000 to 65535)			0.		Allowed	Allowed	
	P115	Easy sequence user parameter U (15)	0. to 9999., 1000 to 6553 (10000 to 65535)			0.		Allowed	Allowed	
	P116	Easy sequence user parameter U (16)	0. to 9999., 1000 to 6553 (10000 to 65535)			0.		Allowed	Allowed	
	P117	Easy sequence user parameter U (17)	0. to 9999., 1000 to 6553 (10000 to 65535)			0.		Allowed	Allowed	
	P118	Easy sequence user parameter U (18)	0. to 9999., 1000 to 6553 (10000 to 65535)			0.		Allowed	Allowed	
	P119	Easy sequence user parameter U (19)	0. to 9999., 1000 to 6553 (10000 to 65535)			0.		Allowed	Allowed	
	P120	Easy sequence user parameter U (20)	0. to 9999., 1000 to 6553 (10000 to 65535)			0.		Allowed	Allowed	
	P121	Easy sequence user parameter U (21)	0. to 9999., 1000 to 6553 (10000 to 65535)			0.		Allowed	Allowed	
	P122	Easy sequence user parameter U (22)	0. to 9999., 1000 to 6553 (10000 to 65535)			0.		Allowed	Allowed	
	P123	Easy sequence user parameter U (23)	0. to 9999., 1000 to 6553 (10000 to 65535)			0.		Allowed	Allowed	
	P124	Easy sequence user parameter U (24)	0. to 9999., 1000 to 6553 (10000 to 65535)			0.		Allowed	Allowed	
	P125	Easy sequence user parameter U (25)	0. to 9999., 1000 to 6553 (10000 to 65535)			0.		Allowed	Allowed	
	P126	Easy sequence user parameter U (26)	0. to 9999., 1000 to 6553 (10000 to 65535)			0.		Allowed	Allowed	
	P127	Easy sequence user parameter U (27)	0. to 9999., 1000 to 6553 (10000 to 65535)			0.		Allowed	Allowed	
	P128	Easy sequence user parameter U (28)	0. to 9999., 1000 to 6553 (10000 to 65535)			0.		Allowed	Allowed	
	P129	Easy sequence user parameter U (29)	0. to 9999., 1000 to 6553 (10000 to 65535)			0.		Allowed	Allowed	
P130	Easy sequence user parameter U (30)	0. to 9999., 1000 to 6553 (10000 to 65535)			0.		Allowed	Allowed		
P131	Easy sequence user parameter U (31)	0. to 9999., 1000 to 6553 (10000 to 65535)			0.		Allowed	Allowed		
User parameters	U001	User-selected function 1	no/d001 to P131			no		Allowed	Allowed	4-76
	U002	User-selected function 2	no/d001 to P131			no		Allowed	Allowed	
	U003	User-selected function 3	no/d001 to P131			no		Allowed	Allowed	
	U004	User-selected function 4	no/d001 to P131			no		Allowed	Allowed	
	U005	User-selected function 5	no/d001 to P131			no		Allowed	Allowed	
	U006	User-selected function 6	no/d001 to P131			no		Allowed	Allowed	
	U007	User-selected function 7	no/d001 to P131			no		Allowed	Allowed	
	U008	User-selected function 8	no/d001 to P131			no		Allowed	Allowed	
	U009	User-selected function 9	no/d001 to P131			no		Allowed	Allowed	
	U010	User-selected function 10	no/d001 to P131			no		Allowed	Allowed	
	U011	User-selected function 11	no/d001 to P131			no		Allowed	Allowed	
	U012	User-selected function 12	no/d001 to P131			no		Allowed	Allowed	

(Note) < > indicate the setting range of 75 to 150kW

(Memo)

Upgrading from the SJ300 Series

The SJ300 series inverter is upwardly compatible with the SJ700 series inverter. Therefore, you can:

- mount the control circuit terminal block board of the SJ300 series in the SJ700 series without removing the connected cables,
- copy the parameter settings from the SJ300 series into the SJ700 series, and
- use the option boards mounted in the SJ300 series for the SJ700 series without removing the connected cables.

(1) Control circuit terminal block board

You can mount the control circuit terminal block board of the SJ300 series into the SJ700 series. Note, however, that the backing plate is incompatible.

(Procedure for replacing the control circuit terminal block board)

As shown in the figure on the right, the fixing screw locations on the control circuit terminal block board are common to the SJ300 and SJ700 series.

To remove and install the control circuit terminal block board, follow the steps 1) to 5) described below.

Precautions:

Use care to prevent the control circuit terminal block board from twisting when removing or mounting it. Otherwise, the board guide pins and connector pins may be damaged.

Do not pull the cables connected to the control circuit terminal block board when you remove the board from the SJ300 series.

Do not forcibly insert the board into the mounting slot. Make sure that the board is correctly fitted onto the board guide pins and the connectors are correctly fitted to each other.

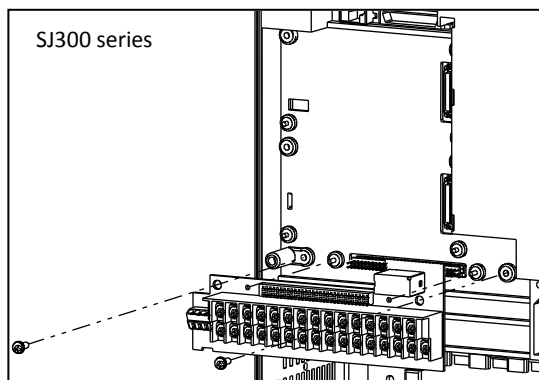
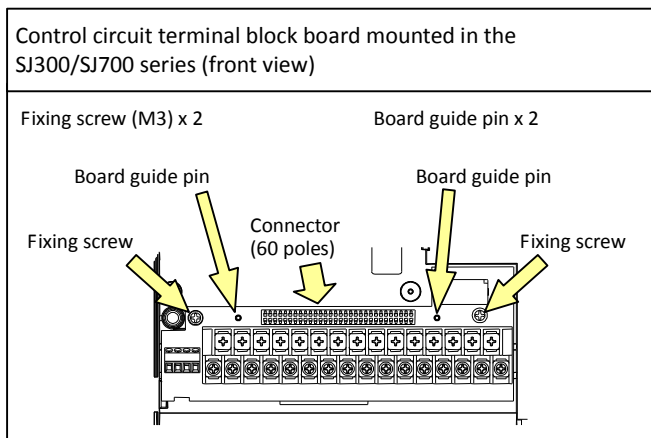

Removing the control circuit terminal block board from the SJ300 series

- 1) Remove two fixing screws from the control circuit terminal block board.
- 2) Pull the control circuit terminal block board straight toward you to remove it from the SJ300 series.

Precautions:

- Pull out the board slowly.
- Be careful not to bend the connector pins.
- Be careful not to break the board guide pins.

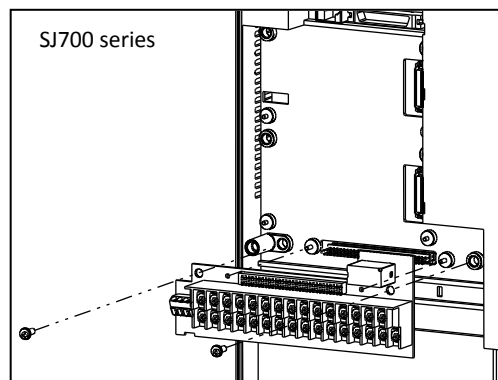

Mounting the removed control circuit terminal block board in the SJ700 series

- 3) Remove the original control circuit terminal block board from the SJ700 series beforehand (as instructed in steps 1) and 2)).
- 4) Insert the control circuit terminal block board removed from the SJ300 series straight into the slot along the board guide pins and connector pins until it touches the fixing-screw seats.

Precautions:

- Push in the board slowly.
- Be careful not to bend the connector pins.
- Be careful not to break the board guide pins.

- 5) Secure the control circuit terminal block board with two fixing screws.

Precaution:

- Be sure to fix the board with the two fixing screws.

(2) Copying the parameter settings

If you use an optional remote operator (SRW-OJ or SRW-OEX), you can copy (import) the parameter settings from the SJ300 series into the SJ700 series. Note, however, that you cannot copy the parameter settings from the SJ700 series to the SJ300 series because the SJ700 series has many new functions and additional parameters.

Precaution: Copying of the data on an optional operator (SRW or SRW-EX)

If you copy parameter data from the SJ700 or SJ300 series inverter in which the slide switch SW1 is set to OFF to the SJ700 series inverter in which the slide switch SW1 is set to ON, the operator may momentarily display an error message "R-ERROR COPY ROM." This event occurs because the data on intelligent input terminals [1] and [3] cannot be copied because the copy-destination SJ700 series has exclusively assigned special functions to these terminals according to the ON setting of the slide switch SW1. Other parameter data is copied. In such cases, confirm the parameter settings on both copy-source and copy-destination inverters before using the copy-destination SJ700 series.

After copying the data, be sure to power off and on again to reflect the copied data.

(3) Option boards

You can use the option boards (SJ-FB, SJ-DG, SJ-DN, SJ-LW, and SJ-PBT) mounted in the SJ300 series for the SJ700 series.

To mount the option boards in the SJ700 series, follow the same mounting procedure as that used for the SJ300 series. For details, refer to the instruction manual for each option board.

Precaution: Since the SJ700 series has many new functions and additional parameters, some functions of the SJ-DN, SJ-LW, and SJ-PBT (option boards conforming to the open network specifications) cannot be implemented on the SJ700 series.

A

a/b.....4-47, 4-61
 absolute position control4-107, 4-108
 acceleration/deceleration patterns.....4-31
 acceleration curve constant4-31
 acceleration time4-10, 4-30
 acceleration (2) time4-30
 acceleration stop4-25
 actual-frequency monitoring4-3, 4-97
 ADD4-14
 AHD4-59
 AL4-60
 alarm code output.....4-65
 alarm relay terminal function.....4-61
 allowable under-voltage power failure time4-33
 AM.....2-7, 4-74
 AMI.....2-7, 4-74
 analog command holding.....4-59
 analog input filter.....4-15
 ascii mode4-117
 AT2-7, 4-12
 ATR4-99
 automatic carrier frequency reduction4-44
 automatic torque boost4-19
 AVR.....4-11
 AVR voltage select.....4-11, 4-15

B

basic display4-76
 base frequency.....4-11
 BER4-81
 binary operation.....4-47, 4-48
 bit operation4-47, 4-48
 BOK4-81
 braking control4-81
 BRD2-12, 4-45
 BRD load factor monitoring.....4-6
 BRK.....4-81

C

capacitor life warning.....4-67
 carrier frequency.....4-42
 CAS4-58
 CE 2-19
 CF1, CF2, CF3, CF44-47
 CM1.....2-7, 2-21
 commercial power supply switching4-53
 communication function4-67, 4-114
 communication line disconnection signal4-67
 constant-torque characteristic (electronic thermal)4-37
 constant-torque characteristic (VC).....4-16, 4-88
 control circuit terminal.....2-7
 control gain switching4-58
 control mode.....4-16
 cooling-fan operation.....4-45, 4-68
 cooling-fan speed drop signal4-68
 copying.....4-94, Appendix-1
 counterrotation prevention.....4-92
 CP1, CP2, CP34-109
 CS4-53

cumulative power monitoring4-4
 cumulative power-on time monitoring4-4, 4-64
 cumulative running time4-4
 current position monitor4-5
 2CH4-30

D

data comparison display.....4-76
 data read/write setting.....4-74
 DB4-20
 DC braking4-20
 DC voltage monitoring.....4-6
 deceleration (2) time setting4-30
 deceleration and stopping at power failure4-84
 deceleration curve constant4-31
 deceleration overvoltage restraint4-42
 deceleration time4-10
 derating4-43
 detection of terminal disconnection4-71
 digital operator.....2-22, 3-3
 display of trip monitoring.....4-6, 5-9
 DSE4-97
 DWN4-56

E

easy sequence4-5, 4-96
 electronic gear.....4-100, 4-102
 electronic thermal4-37
 electronic thermal overload monitoring4-6
 electronic thermal warning level setting4-38
 EMCsafety instructions
 emergency stop2-9
 EMR2-9
 encoder pulse.....4-97,4-104
 end frequency4-14,4-105
 end-frequency rate4-15
 energy-saver operation4-32
 excessive speed5-5
 extended function mode3-8
 external analog input4-12
 external DC braking4-20
 external thermistor4-72
 external trip.....4-57

F

F/R4-57
 F-TM4-51
 factory default(setting)4-75
 FA1, FA2, FA3, FA4, FA5.....4-62
 FBV4-26, 4-29
 feedback.....4-1, 4-28
 feedback option.....4-96
 feed forward selection.....4-28
 FM2-7, 4-73
 FOC4-92
 forcible operation4-51
 forcible-terminal operation4-51
 forcing4-92
 forward rotation signal4-69
 FOT4-111

- FR.....4-68
free setting of electronic thermal
characteristic.....4-38
free V/f characteristic4-17
free-run stop 4-9, 4-52
frequency addition4-14
frequency arrival setting for accel.....4-62
frequency arrival setting for decel.....4-62
frequency limit4-24
frequency lower limit4-24
frequency matching 4-33, 4-52, 4-54
frequency operation.....4-13
frequency reached signal.....4-62
frequency scaling conversion factor4-2
frequency source setting 4-8, 4-113
frequency to be added4-14
frequency upper limit.....4-24
FRS 4-52
function code display restriction3-4, 4-76
function mode.....4-7
fuzzy 4-32, 4-80
FW 2-7, 4-8
FWR.....4-69
- H**
- H 2-7, 2-21
heat sink overheat warning..... 4-61, 4-68
heat sink temperature monitoring4-4
high-resolution absolute position control 4-97,4-107
high-torque multi-motor operation.....4-95
home search.....4-100
- I**
- initial screen4-78
initial screen automatically transition 4-77
initialization.....4-75
input phase loss..... 4-36
input phase loss protection 4-36
input terminal a/b selection..... 4-47,4-61
input terminal response time4-72
inspection..... 1-1, 6-1
instantaneous power failure/
under-voltage trip alarm enable..... 4-33, 4-35
instantaneous power failure or
undervoltage.....4-33
intelligent input terminal..... 2-7, 4-46
intelligent input terminal status4-2
intelligent output terminal 2-8, 4-60
intelligent output terminal status.....4-2
internal DC braking.....4-20
inverter mode monitor4-5
inverter ready signal4-69
IP4-35
IRDY4-69
- J**
- JG.....4-49
jogging.....4-49
jump (center) frequency.....4-25
J3004-85
- K**
- Keypad Run key routing 4-7
KHC 4-4
- L**
- L 2-7, 2-21
LAC4-10, 4-32
LAD 4-10
life-check monitoring..... 4-5, 4-67
LOC 4-69
LOG1, LOG2, LOG3, LOG4, LOG5, LOG6..... 4-66
logical output signal operation 4-66
low-current indication signal 4-69
- M**
- main circuit terminal 2-7
main circuit wiring 2-21
maintenance and inspection 6-1
major failure signal 4-71
maximum frequency..... 4-11
manual torque boost 4-18
MI1, MI2, MI3, MI4, MI5, MI6, MI7, MI8..... 4-47
MO1, MO2, MO3, MI4, MO5, MO6 4-60
modbus RTU 4-130
MJA..... 4-70
monitor mode..... 4-1, 8-1
motor constant 4-85, 4-88
motor gear ratio 4-104
motor temperature monitoring 4-4
multispeed 4 setting 4-47
multistage position switching 4-109
multistage speed/position determination
time 4-48, 4-109
- N**
- NDc 4-67
no..... 4-47
NO/NC 4-47, 4-61
nonstop deceleration at instantaneous
power failure 4-83
- O**
- O 2-7, 2-21
O2 2-7, 2-21, 4-12
O2Dc..... 4-71
OD..... 4-28, 4-29
Odc 4-71
offline auto-tuning..... 4-85
OHF 4-68
OI 2-7, 2-21
OIDc..... 4-71
OL, OL2 4-41
OLR 4-40
online auto-tuning 4-87
ONT..... 4-64
OPE 3-3, 4-8, 4-51

- operating methods.....3-1
operation after option error.....4-79
operation frequency.....4-13
operation mode4-33
operation time over signal (RNT)/plug-in
 time over signal (ONT)4-59, 4-64
operator4-13, 4-66
ORG4-109
ORL.....4-109
ORT.....4-104, 4-110
OTQ4-65
output current monitoring.....4-1
output frequency monitoring.....4-1
output frequency setting4-7
output phase loss4-36
output phase loss protection4-36
output signal delay/hold4-72
output voltage monitoring.....4-3
overcurrent restraint4-40
overload notice advance signal4-40
overload restriction4-40
overtorque4-65
over voltage suppression.....4-41
- P**
- P/PI switching.....4-58
P242-7, 2-21
PCC.....4-59
PCLR4-96
PCNT.....4-5, 4-59
PID 4-26
PIDC.....4-29
POK.....4-104
positioning completed4-104
position bias4-103
position command monitor4-5
position range specification4-110
power monitoring4-3
PPI 4-59
process variable (PV), PID feedback
 monitoring4-1, 4-29
program counter4-5
program number monitoring4-5
programming error monitoring4-6
programmable controller2-22
protective function.....5-1
pulse counter4-5, 4-59
pulse train frequency input.....4-112
pulse train position command4-99
- R**
- reduced-torque characteristic (electronic
 thermal)4-37
reduced torque characteristic (VP).....4-16
reduced voltage start4-43
remote operation4-56
remote operator.....Appendix-1
reset2-9, 3-3, 4-9, 4-54
restart with input frequency4-33, 4-36
retry after trip4-33
retry selection4-33
- reverse rotation signal.....4-60,4-70
reversible4-13, 4-28
RNT4-64
ROT4-110
rotation direction monitoring.....4-1
rotational direction restriction4-7
RS.....2-9, 4-54
RUN3-3, 4-4, 4-60
running time over / power-on time over.....4-60, 4-64
run command source setting.....4-8
running signal4-62
RV4-46
RVR4-60, 4-70
- S**
- scaled output frequency monitoring4-2
2nd/3rd control.....4-50
secondary resistance compensation4-87
sensorless vector control.....4-16, 4-89
servo-on4-111
SET, SET3.....4-50
SFT 4-51
SF1, SF2, SF3, SF4, SF5, SF6, SF74-47
sign of the frequency to be added.....4-14
sink logic2-19
SJ300Appendix-1
slide switch SW1.....2-9, Appendix-1
SLV 4-16
software lock4-51
SON4-111
source logic.....2-22
SPD4-108
speed deviation maximum4-96
speed biasing.....4-103
speed/position switching4-108
STA 4-57
stabilization constant.....4-79
start/end frequency setting for external
 analog input4-14
start frequency4-41
start-frequency rate.....4-14
starting contact signal4-68
start with matching frequency4-33, 4-52
STAT4-96
stop operation selection.....4-9
STOP/RESET key selection.....4-9
STP 4-57
synchronous operation.....4-102
- T**
- teaching.....4-106
test run3-10
thermistor2-8,4-4, 4-72,4-87
THM.....4-39
3-wire input.....4-57
TL.....4-92
torque bias monitoring.....4-3
torque biasing.....4-98
torque boost.....4-17, 4-18
torque command monitoring4-3
torque control4-98

torque limitation 4-92, 4-94
torque LAD stop4-94
torque monitoring4-3
trip Counter4-5
trip monitoring4-6
troubleshooting5-1
TRQ.....4-92
TRQ1, TRQ24-92
2-stage acceleration/deceleration.....4-30
2CH.....4-30

U

UDC4-56
UL2-19
unattended start protection4-55
UP4-56
UP/DWN4-56
user monitor.....4-5
user parameter..... 4-76,4-79
user setting..... 4-77
USP4-56
UV..... 4-35, 4-59

V

V/f gain setting4-15
V2 4-16, 4-96, 4-97
VC4-16
VP 1.7th power4-16
vector control with sensor..... 4-17, 4-96

W

WAC.....4-67
WAF4-68
warning function5-10
WCO 4-71
WCOI 4-71
WCO2 4-71
window comparator 4-71
wiring of control circuit terminal.....2-21

Z

0Hz detection signal4-64
0Hz-range sensorless vector control.....4-16, 4-97
0Hz speed detection signal.....4-64
zero-return function4-109
ZS.....4-64