



MEIDEN
AC SPEED CONTROL EQUIPMENT
THYFREC-VT240S
200V System 0.75 to 90kW Normal Duty
400V System 0.75 to 475kW Normal Duty
INSTRUCTION MANUAL

————— **NOTICE** —————

1. Read this manual thoroughly before using the VT240S, and store in a safe place for reference.
2. Make sure that this manual is delivered to the final user.

MEIDENSHA CORPORATION

Contents

Preface	iii
PRECAUTIONS FOR SAFETY	iv
<Names of each part>	viii
Chapter 1 Delivery Inspection and Storage	1-1
1-1 Delivery inspection and storage	1-1
1-2 Details of rating nameplate and type display method	1-1
Chapter 2 Installation and Wiring	2-1
2-1 Installation environment	2-1
2-2 Installation and wiring method.....	2-3
2-3 Precautions for power supply and motor wiring.....	2-5
2-4 Precautions for wiring to the control signal	2-16
Chapter 3 Test Operation and Adjustment	3-1
3-1 Flow of test operation	3-2
3-2 Preparation before turning power ON	3-3
3-3 Control modes	3-4
3-4 Automatic tuning and test operation	3-5
Chapter 4 Operation Panel	4-1
4-1 Outline of operation panel types and functions.....	4-1
4-2 Various operations and displays when LCD panel is connected	4-6
4-3 Various operations and displays when LED panel is connected.....	4-14
4-4 Customizing block-B, C parameter	4-25
4-5 Changing modes	4-27
Chapter 5 Control Input/Output	5-1
5-1 Input/output terminal function.....	5-1
5-2 Control input/output circuit.....	5-2
5-3 Programmable sequence input function (PSI).....	5-3
5-4 Programmable sequence output function (PSO).....	5-8
5-5 Sequence input logic.....	5-9
5-6 Changing of terminal functions.....	5-10
5-7 Programmable input function (PI)	5-12
5-8 Programmable output function (PO).....	5-16
5-9 Selecting the setting data	5-20
Chapter 6 Control Functions and Parameter Settings	6-1
6-1 Monitor parameters	6-1
6-2 Block-A parameters.....	6-8
6-3 Block-B parameters.....	6-10
6-4 Block-C parameters.....	6-42
6-5 Block-U parameters.....	6-60
6-6 Function explanation	6-76
6-7 Setting the overload mode	6-167
6-8 Adjusting the IM vector control speed control related parameters	6-169
6-9 Adjusting the PM motor control system parameters	6-174

6-10	Operating the auxiliary drive motor	6-182
6-11	Built-in PLC Function.....	6-185
6-12	Explanation of standard serial and Modbus communication	6-192
Chapter 7	Options	7-1
7-1	Outline of options.....	7-1
7-2	Built-in PCB option	7-5
7-3	Dynamic braking (DB) option	7-7
7-4	ACL and DCL	7-11
7-5	EMI filter.....	7-17
Chapter 8	Maintenance and Inspection.....	8-1
8-1	Inspection items.....	8-1
8-2	Measuring devices	8-4
8-3	Protective functions.....	8-5
8-4	Troubleshooting with fault display	8-6
8-5	Troubleshooting with no fault display.....	8-15
Chapter 9	Compatible Standards	9-1
9-1	UL/cUL Standards	9-1
9-2	CE Marking.....	9-5
Appendix 1	Type Description System	A-1
Appendix 2	Outline Dimension Drawings	A-10
Appendix 3.	Fault Codes	A-12
Appendix 4.	Display Messages	A-14
Appendix 5.	Segment LED Display	A-15
Revision history		R-1

Preface

Thank you for purchasing the “Meiden AC Speed Control Equipment THYFREC-VT240S”. THYFREC-VT240S is a highly functional inverter that is easy to use.

Please read this manual thoroughly before use, and keep the manual at hand for later reference. Also make sure that this manual is delivered to the final users.

WARNING

ALWAYS READ THIS MANUAL THOROUGHLY BEFORE USING THE VT240S.

THIS INVERTER CONTAINS HIGH VOLTAGE CIRCUITS THAT MAY BE FATAL TO HUMANS. USE EXTREME CAUTION DURING INSTALLATION. MAINTENANCE MUST BE PERFORMED BY QUALIFIED TECHNICIANS, AND ALL POWER SOURCES MUST BE DISCONNECTED BEFORE ANY MAINTENANCE. SUFFICIENT NOTICE MUST BE GIVEN TO THE GENERAL OPERATORS AND WORKERS BEFORE STARTING.

- ELECTRIC SHOCK MAY OCCUR IF THE FOLLOWING POINTS ARE NOT OBSERVED.
 - (1) DO NOT OPEN THE FRONT COVER WHILE THE POWER IS ON.
 - (2) A CHARGE STILL REMAINS IN THE INVERTER WHILE THE INDICATOR IS LIT EVEN IF THE POWER HAS BEEN TURNED OFF. DO NOT OPEN THE FRONT COVER IN THIS CASE. WAIT AT LEAST 20 MINUTES AFTER THE INDICATOR GOES OUT.
 - (3) DO NOT CONTACT THE ELECTRICAL CIRCUIT WHILE THE "CHARGE" LED ON THE UNIT IS LIT. PERFORM SERVICING, ETC., AFTER WAITING AT LEAST 20 MINUTES AFTER THE LAMP GOES OUT.
 - (4) ALWAYS GROUND THE INVERTER CASE. THE GROUNDING METHOD MUST COMPLY WITH THE LAWS OF THE COUNTRY WHERE THE INVERTER IS BEING INSTALLED.
- THE INVERTER MAY BE DESTROYED BEYOND REPAIR IF THE FOLLOWING POINTS ARE NOT OBSERVED.
 - (1) OBSERVE THE INVERTER SPECIFICATIONS.
 - (2) CONNECT ADEQUATE CABLES TO THE INPUT/OUTPUT TERMINALS.
 - (3) ALWAYS KEEP THE INVERTER INTAKE/OUTTAKE PORTS CLEAN, AND PROVIDE ENOUGH VENTILATION.
 - (4) ALWAYS OBSERVE THE CAUTIONS LISTED IN THIS INSTRUCTION MANUAL.
- THERE MAY BE SOURCES OF NOISE AROUND THIS INVERTER AND MOTOR DRIVEN BY THIS INVERTER. CONSIDER THE POWER SUPPLY SYSTEM, INSTALLATION PLACE AND WIRING METHOD BEFORE INSTALLATION.
INSTALL THIS INVERTER AWAY FROM DEVICES THAT HANDLE MINUTE SIGNALS, SUCH AS MEDICAL EQUIPMENT IN PARTICULAR. ALSO SEPARATE THE DEVICES ELECTRICALLY, AND TAKE SUFFICIENT NOISE MEASURES.
- TAKE SUFFICIENT SAFETY MEASURES WHEN USING THIS INVERTER FOR PASSENGER TRANSPORTATION, SUCH AS IN LIFTS (ELEVATORS).
- LONGEVITY MIGHT BECOME REMARKABLY SHORT BY THE TEMPERATURE CHANGE'S BY THE CURRENT OF THE REPETITION ALWAYS JOINING IN THE POWER DEVICE WHEN USED BY THE USAGE WITH HIGH REPETITION FREQUENCY OF DRIVING AND THE STOP (ELEVATOR AND CRANE, ETC.).
WHEN USED BY SUCH A USAGE, DIRATING (FRAME RAISING OF THE INVERTER, CURRENT DECREASE WHEN STARTING AND STOPPING, AND DECREASE OF THE CAREER FREQUENCY) IS NEEDED.
PLEASE INQUIRE SEPARATELY ABOUT DETAILS.

PRECAUTIONS FOR SAFETY

Items to be observed to prevent physical damage or property damage and to ensure safe use of this product are noted on the product and in this instruction manual.

- Please read this instruction manual and enclosed documents before starting operation to ensure correct usage. Thoroughly understand the device, safety information and precautions before starting operation. After reading, always store this manual where it can be accessed easily.
- The safety precautions are ranked as "**DANGER**" and "**CAUTION**" in this instruction manual.



: When a dangerous situation may occur if handling is mistaken leading to fatal or major injuries.



: When a dangerous situation may occur if handling is mistaken leading to medium or minor injuries, or physical damage.

Note that some items described as  may lead to major results depending on the situation. In any case, important information that must be observed is described.

- This instruction manual is written on the premise that the user has an understanding of the inverter. Installation, operation, maintenance and inspection of this product must be done by a qualified person. Even qualified persons must undergo periodic training.

Qualified refers to satisfying the following conditions.

- The person has thoroughly read and understood this instruction manual.
- The person is well versed in the installation, operation, maintenance and inspection of this product, and understands the possible dangers.
- The person is informed on matters related to starting, stopping, installation, locks and tag displays, and has been trained in the operation and remedies.
- The person has been trained on the maintenance, inspection and repairs of this product.
- The person has been trained on protective tools used to ensure safety.

1. Transportation and installation



CAUTION

- Always transport the product with an appropriate amount according to the products weight.
Failure to observe this could lead to injuries.
- Install the inverter, dynamic braking unit and resistor, and other peripheral devices on non-combustible material such as metal.
Failure to observe this could lead to fires.
- Do not place the product near inflammable items.
Failure to observe this could lead to fires.
- Do not hold the front cover while transporting the product.
Failure to observe this could lead to injuries from dropping.
- Do not let conductive materials such as screws or metal pieces and inflammable materials such as oil enter the product.
Failure to observe this could lead to fires.
- Install the product in a place that can withstand the weight of the product, and follow the instruction manual.
Failure to do so could lead to injuries from dropping.
- Do not install and operate an inverter that is damaged or that has missing parts.
Failure to observe this could lead to injuries.
- Always observe the conditions described in the instruction manual for the installation environment.
Failure to observe this could lead to faults.

2. Wiring



DANGER

- Always turn the device's input power OFF before starting wiring.
Failure to do so could lead to electric shocks or fires.
- Carry out grounding that complies with the standards of the country where the inverter is being installed.
Failure to do so could lead to electric shocks or fires.
- When using the PM motor, even if the inverter is stopped, the voltage will be generated at the output terminal (U, V, W) during rotation. Always carry out wiring while the motor is stopped.
Failure to do so could lead to electric shocks or injuries.
- Wiring must always be done by a qualified electrician.
Failure to observe this could lead to electric shocks or fires.
- Always install the device before starting wiring.
Failure to do so could lead to electric shocks or injuries.
- Prepare a breaker such as an MCCB or fuses that matches the capacity for the inverter's power supply side.
Failure to do so could lead to fires.



CAUTION

- Do not connect an AC power supply to the output terminals (U, V, W).
Failure to observe this could lead to injuries or fires.
- Confirm that the product's rated voltage and frequency match the power supply voltage and frequency.
Failure to do so could lead to injuries or fires.
- Install an overheating protection device on the dynamic braking unit and resistor, and shut off the power with this fault signal.
Failure to do so could lead to fires in the event of abnormal overheating.
- Do not directly connect a resistor to the DC terminals (between L+1, L+2, and L-).
Failure to observe this could lead to fires.
- Tighten the terminal screws with the designated tightening torque.
Failure to do so could lead to fires.
- Correctly connect the output side (U, V, W).
Failure to do so could cause the motor to rotate in reverse and the machine to be damaged.
- Always correctly connect when using the encoder.
The signal polarity specifications differ according to the encoder. With reference to the item of a test operation, please be alike with a parameter setup (C51) and adjust signal polarity more.
Failure to observe this could lead to reverse rotation or abnormal acceleration of the motor, and to injuries or machine damage.

3. Operation

DANGER

- Always install the front cover before turning the input power ON. Never remove the cover while the power is ON. There are sections in the front PCB that are charged with high voltages.
Failure to observe this could lead to electric shocks.
- Never touch the switches with wet hands.
Failure to observe this could lead to electric shocks.
- Never touch the inverter's terminals while the inverter power is ON even if the operation is stopped.
Failure to observe this could lead to electric shocks.
- Selection of the retry function could lead to unexpected restarting when alarm stops. The machine may start suddenly if the power is turned ON when the automatic start function is selected. Do not go near the machine.
(Design the machine so that physical safety can be ensured even if the machine restarts.)
Failure to do so could lead to injuries.
- The machine may not stop when a stop command is issued if the deceleration stop function is selected and the overvoltage/overcurrent limit function is activated. Prepare a separate emergency stop switch.
Failure to do so could lead to injuries.
- The unit will not suddenly restart even if the alarm is reset with the operation signal input, however, in order to prevent unexpected operation, ensure that the operation signal is no longer being input, and reset the alarm.
Failure to do so could lead to injuries.

CAUTION

- The heat sink and dynamic braking resistor are heated to high temperatures, so never touch them.
Failure to observe this could lead to burns.
- Do not block the inverter's ventilation holes.
Failure to observe this could lead to fires.
- The inverter operation can easily be set from low speeds to high speeds, so confirm that the operation is within the tolerable range for the motor or machine before making settings.
Failure to do so could lead to injuries.
- Prepare holding brakes when necessary. Holding is not possible with the inverter's brake functions.
Failure to do so could lead to injuries.
- Confirm the operation of the motor as a single unit before operating the machine.
Failure to do so could lead to injuries or machine damage due to unforeseen movements.
Always prepare a safety backup device so that the machine is not placed in a hazardous situation when an error occurs in the inverter.
Failure to do so could lead to injuries or machine damage or fires.
- Please do not detach the operation panel while the inverter power is ON. Please detach the operation panel in the state of power supply OFF. When the operation panel is installed while the inverter power is ON, the microcomputer of the inverter is occasionally reset.

4. Maintenance, inspection and part replacement



- Always wait at least 20 minutes after turning the input power OFF before starting inspections. Wait at least 20 minutes after turning the input power OFF before starting work. Make sure that the displays on the operation panel have gone out before removing the front cover. Remove the front cover, and confirm that the "CHARGE" LED on the unit has gone out. Also check that the voltage between terminals L+1 or L+2 and L– is 15V or less before starting the inspections. (Check with the "CHARGE" LED if the unit is not provided with the L– terminal.) Failure to observe this could lead to electric shocks.
- Maintenance, inspections and part replacement must be done by a designated person. (Remove all metal accessories such as watches, bracelets, etc., before starting the work.) (Always use an insulation measure tool.) Failure to observe this could lead to electric shocks and injuries.
- Always turn the power OFF before inspecting the motor or machine. A potential is applied on the motor terminal even when the motor is stopped. Failure to do so could lead to electric shocks and injuries.
- Do not use parts other than those designated for the replacement parts. Contact your inverter dealer for replacement parts. Failure to observe this could lead to fires.



- Vacuum the inverter with a vacuum cleaner to clean it. Do not use water or organic solvents. Failure to observe this could lead to fires or damage.

5. Others



- Never modify the product. Failure to observe this could lead to electric shocks or injuries.



- Dispose of this product as industrial waste.

<Names of each part>

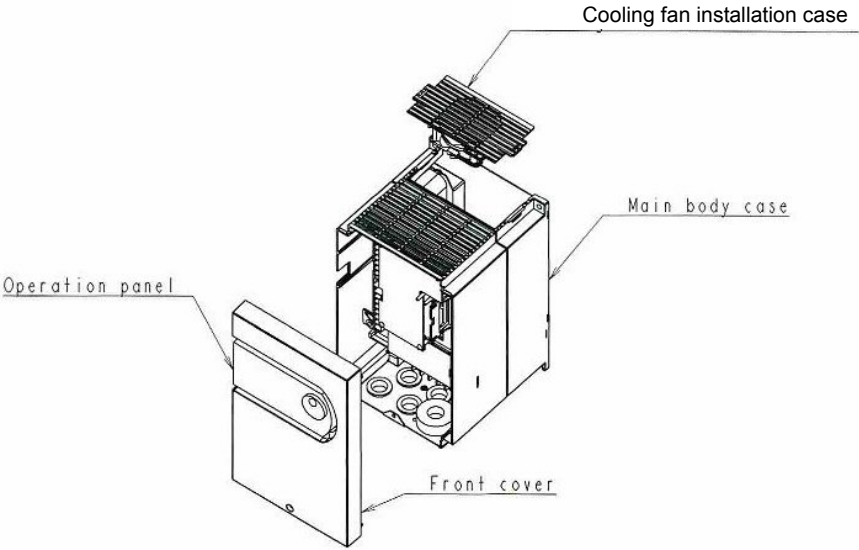

For 018L, 030H and smaller

The presence and quantity of cooling fans will differ according to the capacity.

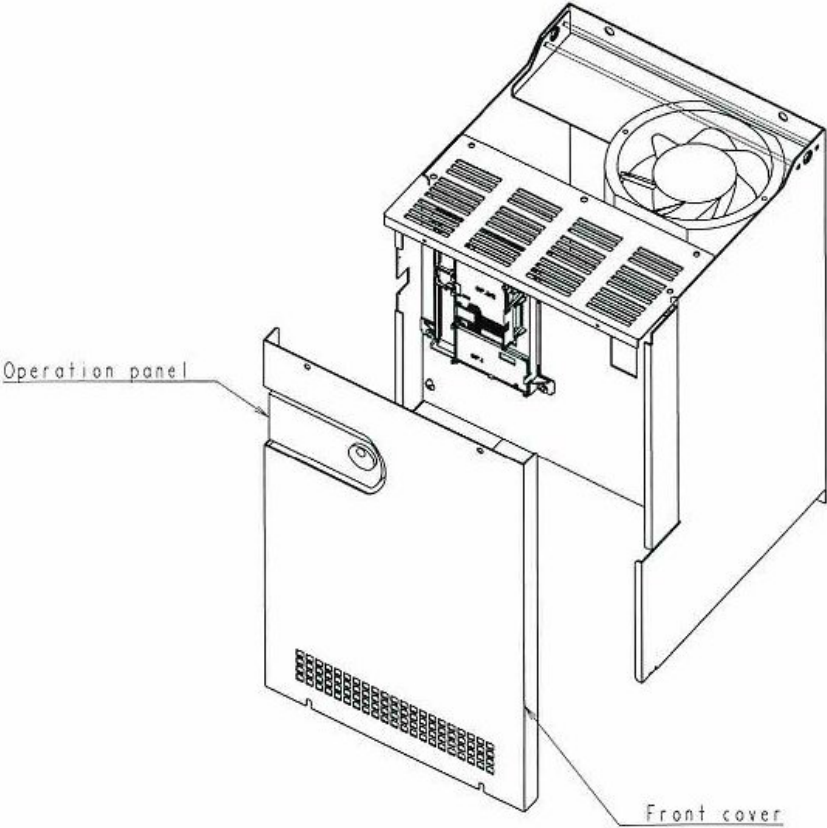

For 022L and larger, 037H and larger

Chapter 1 Delivery Inspection and Storage

1-1 Delivery inspection and storage

- (1) Remove the inverter from the packaging, and check the details on the rating nameplate to confirm that the inverter is as ordered. The rating nameplate is on the left side of the unit.
- (2) Confirm that the product has not been damaged.
- (3) If the inverter is not to be used for a while after purchasing, store it in a place with no humidity or vibration in the packaged state.
- (4) Always inspect the inverter before using after storing for a long period. (Refer to 8-1.)

1-2 Details of rating nameplate and type display method

- (1) The following details are listed on the rating nameplate.

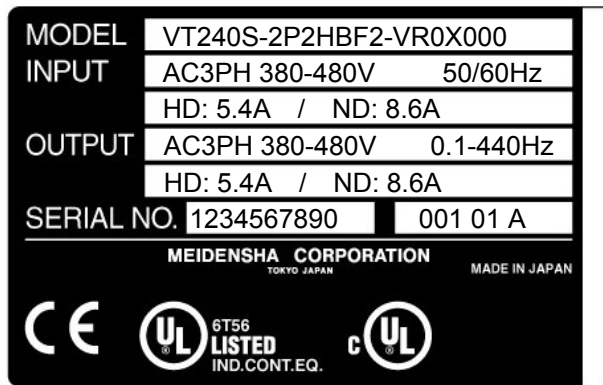

(Note 1) Refer to Chapter 9 for details on UL Instruction.

- (2) Using the above type as an example, the type is displayed as follows:

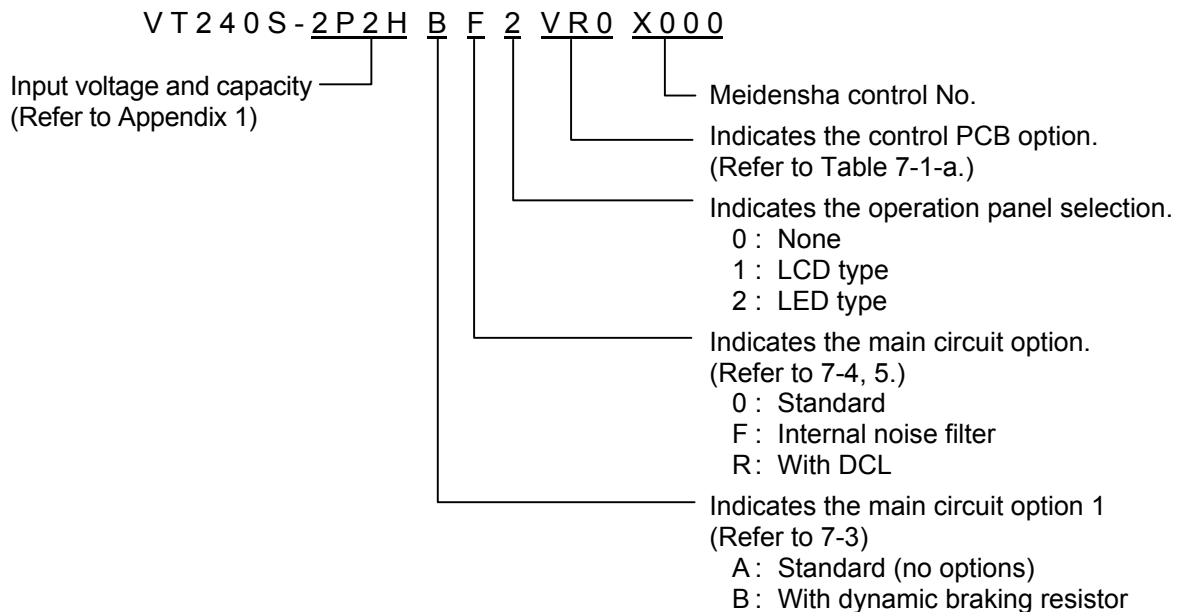



Chapter 2 Installation and Wiring

 CAUTION
<ul style="list-style-type: none"> • Always transport the product with an appropriate amount according to the products weight. Failure to observe this could lead to injuries. • Install the inverter, dynamic braking unit and resistor, and other peripheral devices on non-combustible material such as metal. Failure to observe this could lead to fires. • Do not place the product near inflammable items. Failure to observe this could lead to fires. • Do not hold the front cover while transporting the product. Failure to observe this could lead to injuries from dropping. • Do not let conductive materials such as screws or metal pieces and inflammable materials such as oil enter the product. Failure to observe this could lead to fires. • Install the product in a place that can withstand the weight of the product, and follow the instruction manual. Failure to do so could lead to injuries from dropping. • Do not install and operate an inverter that is damaged or that has missing parts. Failure to observe this could lead to injuries. • Always observe the conditions described in the instruction manual for the installation environment. Failure to observe this could lead to faults.

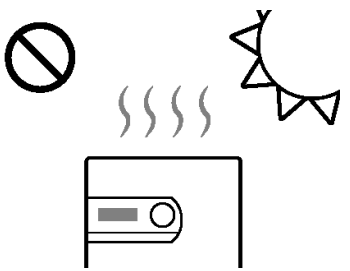
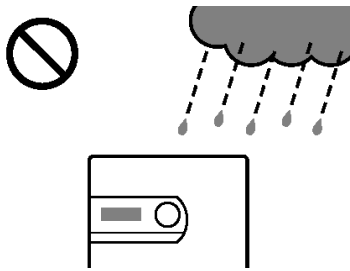
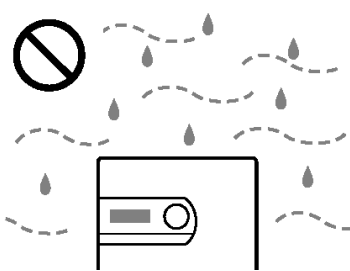
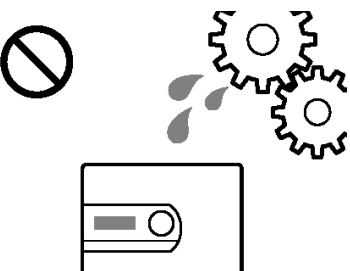

2-1 Installation environment

Observe the following points when installing the inverter.

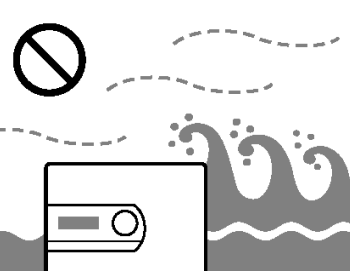
- (1) Install the inverter vertically so that the cable lead-in holes face downward.
- (2) Make sure that the ambient temperature is -10°C to 50°C . (Refer to Appendix 1.)
- (3) Avoid installation in the following environment.

Place subject to direct sunlight	Place subject to wind, rain or water	Place with high levels of humidity
		
Place subject to oil drops	Place where dust, cotton lint or iron chips, etc., are present	Place with high levels of salt
		

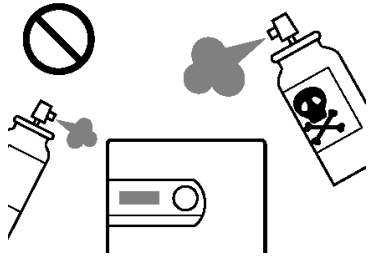
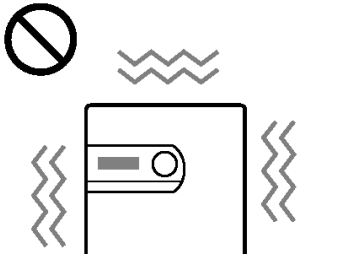
2. Installation and Wiring

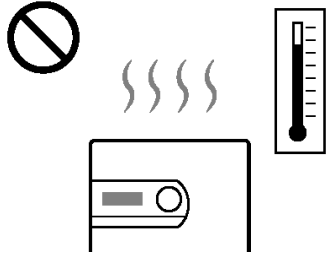
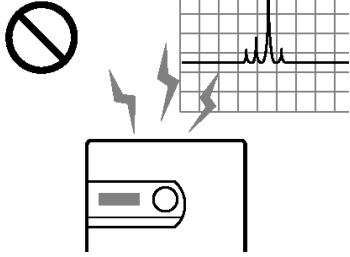
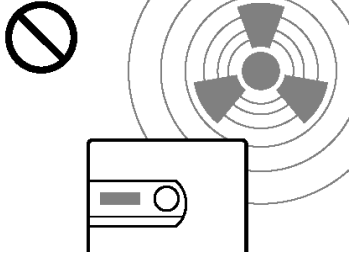
Place with harmful corrosive or explosive gases or fluids are present	Place near sources of vibration such as dollies or press machines	Place where flammable materials are present
		
Place with high levels of ambient temperature	Places with high levels of magnetic noise	Places where radioactive substances are present
		

(4) Ensure ventilation space around the inverter. (Refer to Fig. 2-1.)

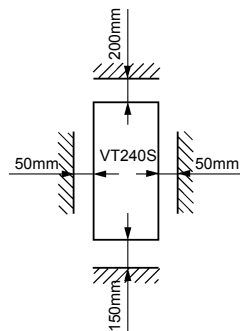

For 018L, 030H and smaller

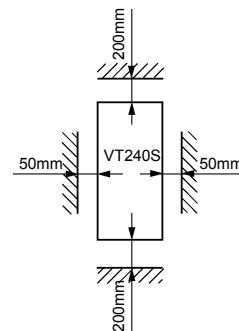

For 022L, 037H and larger

Fig. 2-1

2-2 Installation and wiring method

Installation and wiring for the 018L and 030H and below, and the wiring for the 022L and 037H and above are carried out with the front cover removed. The operation panel is fixed with the latches for the operation panel mounting holder, so the front cover can be removed with the operation panel attached.

To remove the operation panel, securely hold the panel with a thumb on the lower side and another finger on the top side as shown on the right, and pull the panel forward and off. To mount the operation panel, hold it the top and bottom sides with five fingers, and press the panel on horizontally. Confirm that the operation panel is securely fixed with the latches for the operation panel mounting holder.

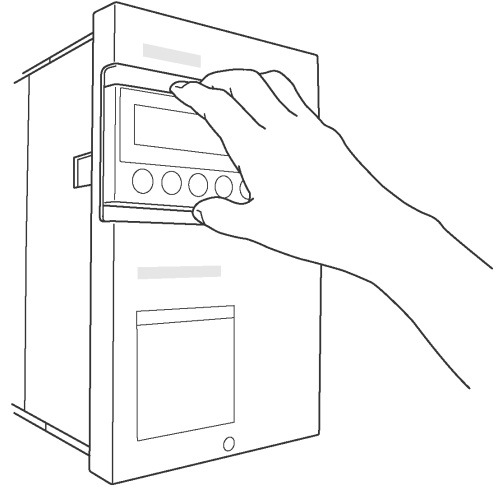

(1) 018L, 030H and smaller (Fig. 2-2-a)

Fix the VT240S at four places when installing. The lower two installation sections are notched. Remove the front cover, and wire to the main circuit and control terminal block.

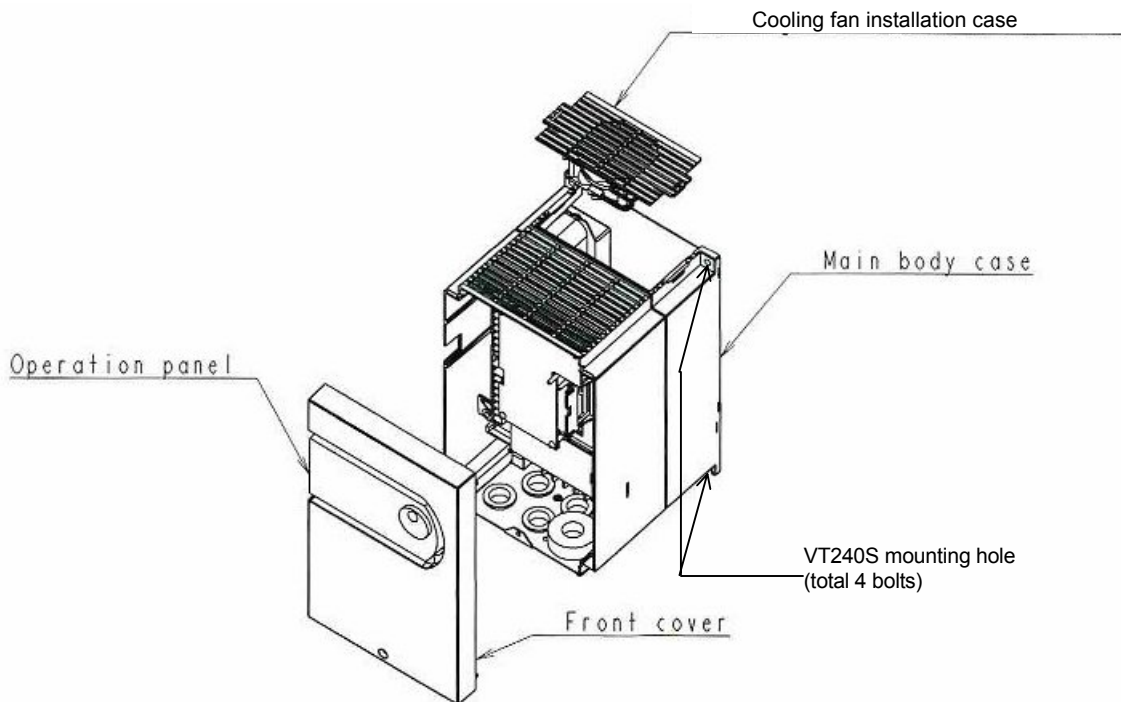

2. Installation and Wiring

(2) 022L, 037H and larger (Fig. 2-2-b)

Fix the VT240S at four places when installing. The VT240S mass is more than 25kg, so installation by two workers is recommended. When two workers are installing the unit, they should confirm each step with signals. Wire in the same manner as step (1).

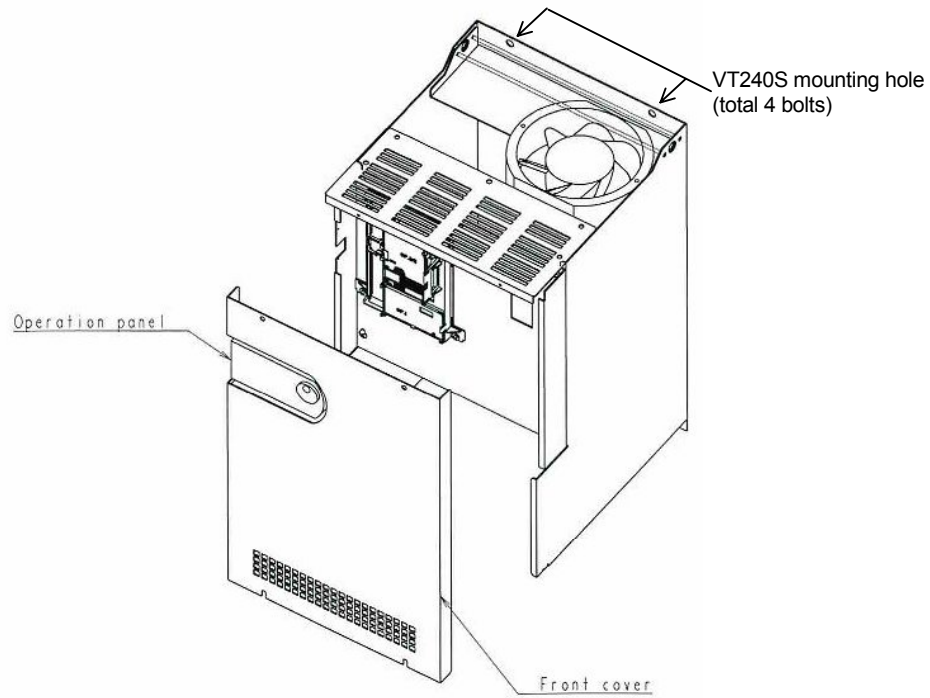

2-3 Precautions for power supply and motor wiring

DANGER

- Always turn the device's input power OFF before starting wiring.
Failure to do so could lead to electric shocks or fires.
- Carry out grounding that complies with the standards of the country where the inverter is being installed.
Failure to do so could lead to electric shocks or fires.
- When using the PM motor, even if the inverter is stopped, the voltage will be generated at the output terminal (U, V, W) during rotation. Always carry out wiring while the motor is stopped.
Failure to do so could lead to electric shocks or injuries.
- Wiring must always be done by a qualified electrician.
Failure to observe this could lead to electric shocks or fires.
- Always install the device before starting wiring.
Failure to do so could lead to electric shocks or injuries.
- Prepare a breaker such as a non-fuse breaker (MCCB) or fuse that matches the capacity for the inverter's power supply side.
Failure to do so could lead to fires.

CAUTION

- Do not connect an AC power supply to the output terminals (U, V, W).
Failure to observe this could lead to injuries or fires.
- Confirm that the product's rated voltage and frequency match the power supply voltage and frequency.
Failure to do so could lead to injuries or fires.
- Install an overheating protection device on the dynamic braking resistor, and shut off the power with an error signal.
Failure to do so could lead to fires in the event of abnormal overheating.
- Do not directly connect a resistor to the DC terminals (between L+1, L+2 and L-).
Failure to observe this could lead to fires.
- Tighten the terminal screws with the designated tightening torque.
Failure to do so could lead to fires.
- Correctly connect the output side (U, V, W).
Failure to observe this could lead to reverse rotation of the motor, and to injuries or machine damage.
- Always correctly connect when using the encoder.
The signal polarity specifications differ according to the encoder. With reference to the item of a test operation, please be alike with a parameter setup (C50, C51) and adjust signal polarity more.
Failure to observe this could lead to reverse rotation or abnormal acceleration of the motor, and to injuries or machine damage.

Refer to Fig. 2-3-a and wire the main circuits for the power supply and motor, etc.
Always observe the following precautions for wiring.

CAUTION

There is a risk of electric shocks.

The VT240S has a built-in electrolytic capacitor, so a charge will remain even when the inverter power is turned OFF. Always observe the followings before carrying out wiring work.

- Wait at least 20 minutes after turning the power OFF before starting work. Make sure that the displays on the operation panel have gone out before removing the cover.
- After removing the cover, confirm that the "CHARGE" LED in the unit has gone out. Also check that the voltage between terminals L+1 or L+2 and L- is 15V or less before starting the wiring work. (Check with the "CHARGE" LED if the unit is not provided with the L- terminal.)

2. Installation and Wiring

(a) 018L, 022H and smaller

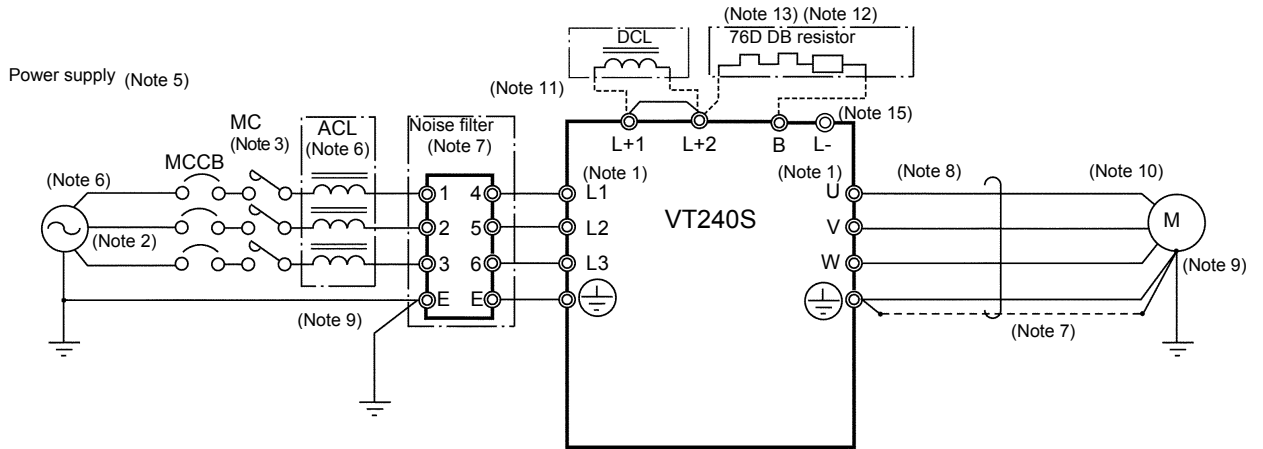

(b) 022L to 090L, 030H to 055H

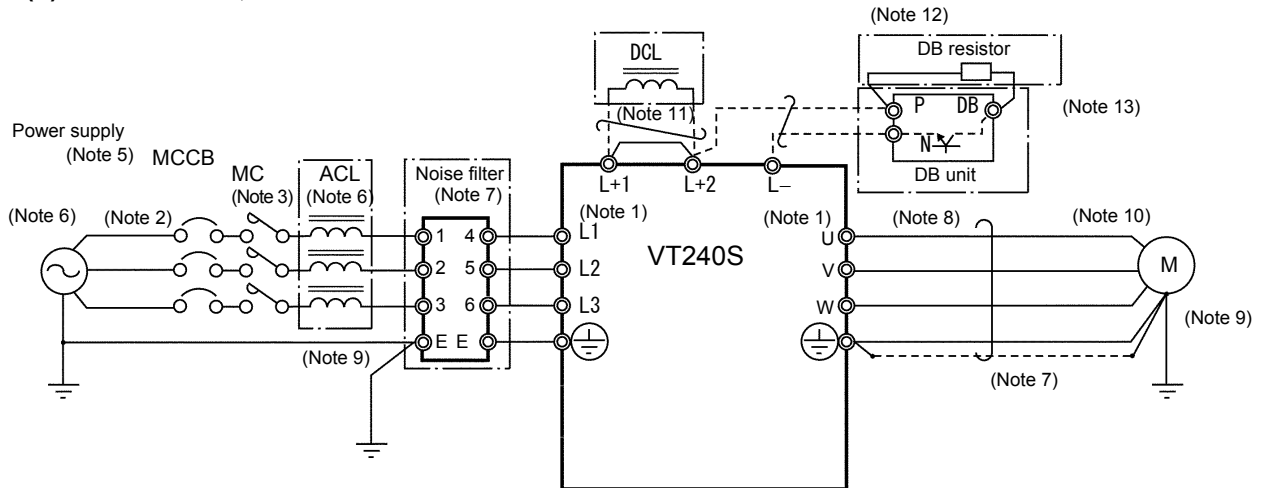

(c) 075H to 475H

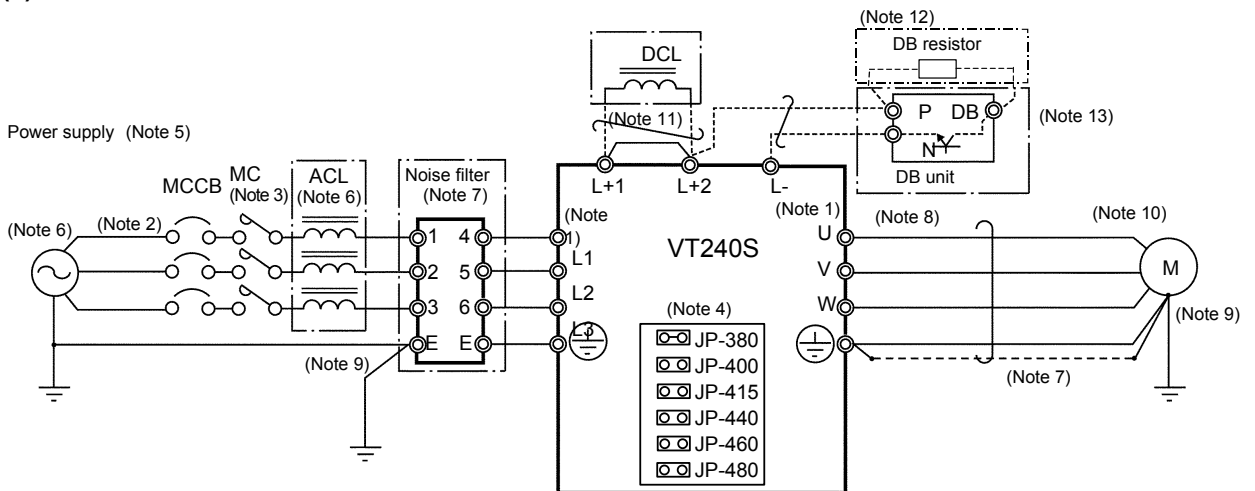

Fig. 2-3-a Example of main circuit wiring

(Note 1) Configuration of inverter's main circuit

The inverter input terminals are L1, L2 and L3. The output terminals to the motor are U, V and W. Do not connect the power supply to the U, V, W terminals. Incorrect wiring will lead to inverter damage or fires.

The VT240S main circuit configuration is largely divided into three types according to the capacity zone.

- (1) The first type is the 011L/015H and smaller capacities. The L+1 and L+2 terminals are located in the step before the pre-charge circuit. The DB circuit is built-in, and the use of the built-in DB resistor can be selected with options. The use of the built-in EMC filter can also be selected with options. Note that the external EMC filter must be used for the 7P5L and 011L capacity.
With the 011L/015H and smaller capacity, the L+2 and L- terminals for connecting the PWM converter are provided as a standard. When using the PWM converter, refer to the DC Input Option Supplement Manual. Prepare a D-type option for all other capacities.
- (2) The second type is the 015L, 018L/018H, and 022H capacities. The L+1 and L+2 terminals are located in the step after the pre-charge circuit. The DB circuit is built-in, but the DB resistor must be prepared by the customer. With the 018H and 022H capacities, the use can be selected with the built-in EMC filter options. Use an external EMC filter with the 015L and 018L capacities.
- (3) The third type is the 022L/030H and larger capacities. The L+1 and L+2 terminals are located in the step after the pre-charge circuit. The built-in DCL can be selected as an option. A standalone DCL can also be selected. With the 030H, the use of the built-in EMC filter can be selected with options. Use an external EMC filter with the 022L/037H and larger capacities.

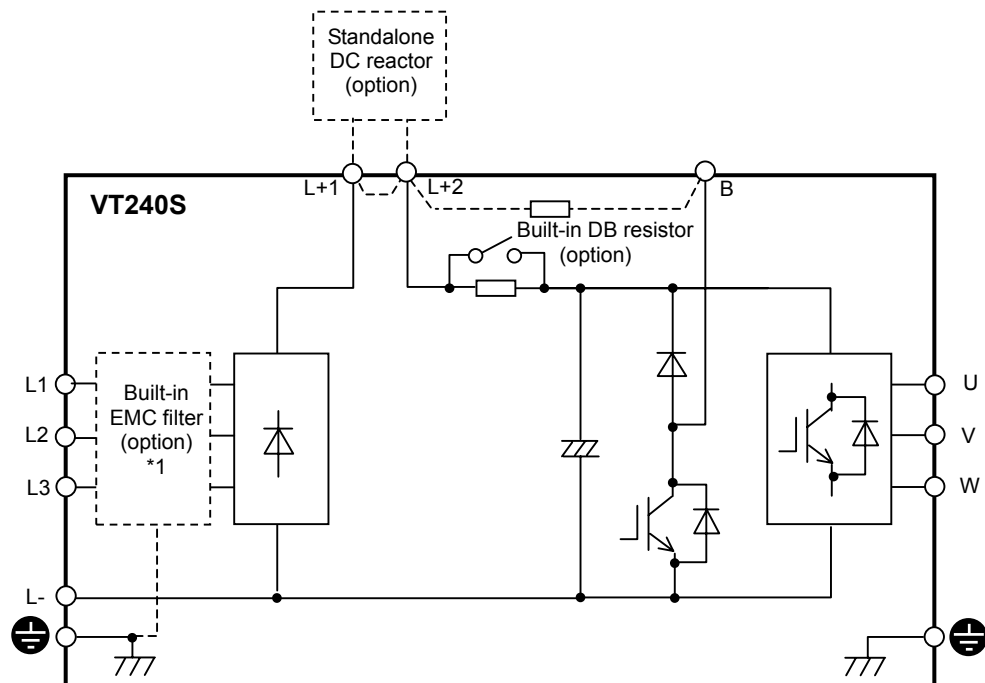

*1) Incompatible with 7P5L and 011L

(1) 011L/015H and smaller capacities

2. Installation and Wiring

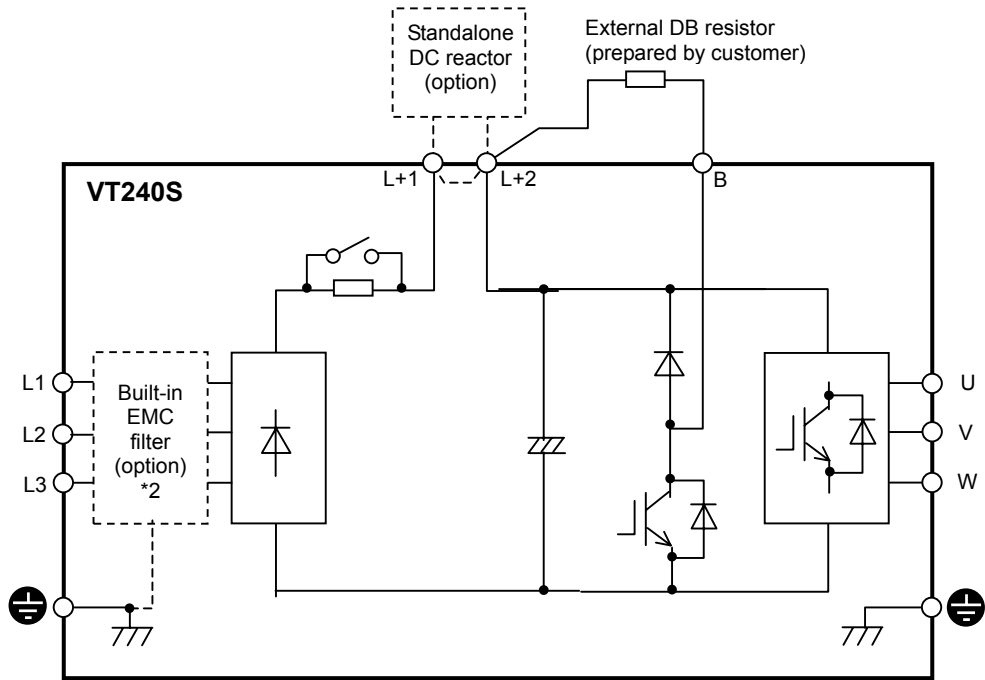

*2) Incompatible with 015L and 018L

(2) 015L, 018L/018H, 022H

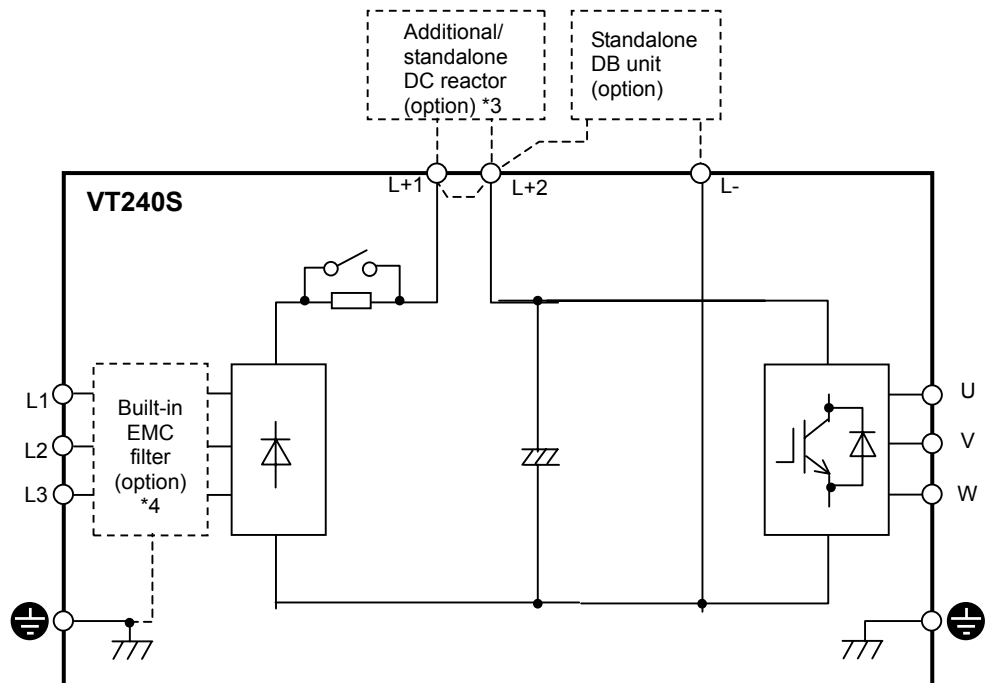

*3) Only standalone type is available for 030H

*4) Only compatible with 030H

(3) 022L/030H and larger capacities

2. Installation and Wiring

(Note 2) Wire size

Use wires having the wire size shown in Table 2-3-a and Table 2-3-b for the main circuit wiring shown in Fig. 2-3-a.

Table 2-3 gives the screw sizes, applicable wire sizes and tightening torque for the main circuit terminal shown in Fig. 2-3-b.

Table 2-3-a Terminal and applicable wire (for normal-duty)

Inverter type VT240S-□	Power supply, motor, DCL wiring					DB wiring				
	Terminal screw size	Wire size		Tightening torque		Terminal screw size	Wire size		Tightening torque	
		AWG	mm ²	N · m	lb-in		AWG	mm ²	N · m	lb-in
0P7L	M4	14	2.1	1.2	10.6	M4	14	2.1	1.2	10.6
1P5L	M4	14	2.1	1.2	10.6	M4	14	2.1	1.2	10.6
2P2L	M4	14	2.1	1.2	10.6	M4	14	2.1	1.2	10.6
4P0L	M4	10	5.3	2.0	17.7	M4	14	2.1	2.0	17.7
5P5L	M4	8	8.4	2.0	17.7	M4	14	2.1	2.0	17.7
7P5L	M5	8	8.4	2.0	17.7	M5	14	2.1	2.0	17.7
011L	M5	6	13.3	4.5	39.8	M5	14	2.1	4.5	39.8
015L	M6	3	26.7	9.0	79.6	M6	14	2.1	9.0	79.6
018L	M8	2	33.6	9.0	79.6	M8	12	3.3	9.0	79.6
022L	M8	1	42.4	9.0	79.6	M8	10	5.3	9.0	79.6
030L	M8	2/0	67.4	9.0	79.6	M8	10	5.3	9.0	79.6
037L	M10	4/0	107.0	18.0	159.3	M5	6	13.3	18.0	159.3
045L	M10	1/0 × 2	53.5 × 2	28.9	255.7	M5 (L-) M10 (L+2)	6	13.3	2.5 28.9	22.1 255.7
055L	M10	1/0 × 2	53.5 × 2	28.9	255.7	M5 (L-) M10 (L+2)	6	13.3	2.5 28.9	22.1 255.7
075L										
090L										
0P7H	M4	14	2.1	1.2	10.6	M4	14	2.1	1.2	10.6
1P5H	M4	14	2.1	1.2	10.6	M4	14	2.1	1.2	10.6
2P2H	M4	14	2.1	1.2	10.6	M4	14	2.1	1.2	10.6
4P0H	M4	14	2.1	1.2	10.6	M4	14	2.1	1.2	10.6
5P5H	M4	12	3.3	1.2	10.6	M4	14	2.1	1.2	10.6
7P5H	M4	10	5.3	2.0	17.7	M4	14	2.1	2.0	17.7
011H	M4	8	8.4	2.0	17.7	M4	14	2.1	2.0	17.7
015H	M5	8	8.4	2.0	17.7	M5	14	2.1	2.0	17.7
018H	M5	6	13.3	2.0	17.7	M5	14	2.1	2.0	17.7
022H	M5	6	13.3	4.5	39.8	M5	14	2.1	4.5	39.8
030H	M6	4	21.2	9.0	79.6	M6	12	3.3	9.0	79.6
037H	M8	2	33.6	9.0	79.6	M8	10	5.3	9.0	79.6
045H	M8	1	42.4	9.0	79.6	M8	6	13.3	9.0	79.6
055H	M8	1/0	53.5	18.0	159.3	M8	6	13.3	18.0	159.3
075H										
090H										
110H										
132H										
160H										
200H										
250H										
315H										
400H										
475H										

2. Installation and Wiring

Table 2-3-b Terminal and applicable wire (for heavy-duty)

Inverter type VT240S-□	Power supply, motor, DCL wiring					DB wiring				
	Terminal screw size	Wire size		Tightening torque		Terminal screw size	Wire size		Tightening torque	
		AWG	mm ²	N • m	lb-in		AWG	mm ²	N • m	lb-in
0P7L	M4	14	2.1	1.2	10.6	M4	14	2.1	1.2	10.6
1P5L	M4	14	2.1	1.2	10.6	M4	14	2.1	1.2	10.6
2P2L	M4	14	2.1	1.2	10.6	M4	14	2.1	1.2	10.6
4P0L	M4	14	2.1	2.0	17.7	M4	14	2.1	2.0	17.7
5P5L	M4	10	5.3	2.0	17.7	M4	14	2.1	2.0	17.7
7P5L	M5	8	8.4	2.0	17.7	M5	14	2.1	2.0	17.7
011L	M5	8	8.4	4.5	39.8	M5	14	2.1	4.5	39.8
015L	M6	6	13.3	9.0	79.6	M6	14	2.1	9.0	79.6
018L	M8	3	26.7	9.0	79.6	M8	14	2.1	9.0	79.6
022L	M8	2	33.6	9.0	79.6	M8	12	3.3	9.0	79.6
030L	M8	1	42.4	9.0	79.6	M8	10	5.3	9.0	79.6
037L	M10	2/0	67.4	18.0	159.3	M5	10	5.3	18.0	159.3
045L	M10	4/0	107.0	28.9	255.7	M5 (L-) M10 (L+2)	6	13.3	2.5 28.9	22.1 255.7
055L	M10	1/0 × 2	53.5 × 2	28.9	255.7	M5 (L-) M10 (L+2)	6	13.3	2.5 28.9	22.1 255.7
075L										
090L										
0P7H	M4	14	2.1	1.2	10.6	M4	14	2.1	1.2	10.6
1P5H	M4	14	2.1	1.2	10.6	M4	14	2.1	1.2	10.6
2P2H	M4	14	2.1	1.2	10.6	M4	14	2.1	1.2	10.6
4P0H	M4	14	2.1	1.2	10.6	M4	14	2.1	1.2	10.6
5P5H	M4	14	2.1	1.2	10.6	M4	14	2.1	1.2	10.6
7P5H	M4	12	3.3	2.0	17.7	M4	14	2.1	2.0	17.7
011H	M4	10	5.3	2.0	17.7	M4	14	2.1	2.0	17.7
015H	M5	8	8.4	2.0	17.7	M5	14	2.1	2.0	17.7
018H	M5	8	8.4	2.0	17.7	M5	14	2.1	2.0	17.7
022H	M5	6	13.3	4.5	39.8	M5	14	2.1	4.5	39.8
030H	M6	6	13.3	9.0	79.6	M6	14	2.1	9.0	79.6
037H	M8	4	21.2	9.0	79.6	M8	12	3.3	9.0	79.6
045H	M8	2	33.6	9.0	79.6	M8	10	5.3	9.0	79.6
055H	M8	1	42.4	18.0	159.3	M8	6	13.3	18.0	159.3
075H										
090H										
110H										
132H										
160H										
200H										
250H										
315H										
400H										
475H										

2. Installation and Wiring

(Note 3) Breaker for wiring

Install a non-fuse breaker (MCCB) or Fuse and MC on the power supply side of the inverter. Refer to Table 7-1-b and select the MCCB or Fuses. When using as a UL/cUL Standard certified product, install the UL certified fuse or MCCB as explained in section 9-1.

(Note 4) Selection of power voltage for auxiliary equipment power supply

For the 400V Series (075H and larger), switch the auxiliary equipment power supply selection connector according to the rated voltage of the power being used. If the following settings do not apply to the power voltage being used, select the closest power voltage.

- For 380V, short circuit across JP-380
- For 400V, short circuit across JP-400
- For 415V, short circuit across JP-415
- For 440V, short circuit across JP-440
- For 460V, short circuit across JP-460
- For 480V, short circuit across JP-480(factory setting state)

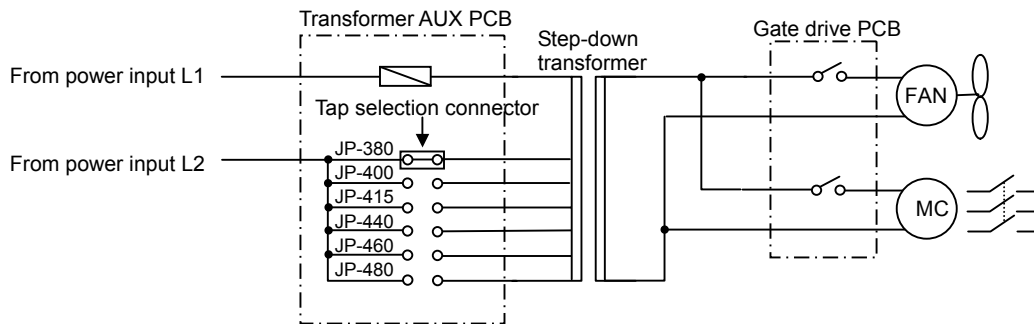

(Note 5) Power voltage/frequency

Prepare the power supply to match the following power voltage and frequency.

Voltage system	Type	Power voltage	Frequency
L series	0P7L to 011L	200 to 240V ± 10%	50/60Hz ± 5%
	015L to 090L	200 to 230V ± 10%	50/60Hz ± 5%
H series	0P7H to 475H	380 to 480V ± 10%	50/60Hz ± 5%

(Note 6) Power supply capacity

Make sure that capacity of the transformer used as the inverter's power supply is within the following range. (For 4% impedance transformer)

- Heavy-duty rating (055H and smaller) 500kVA or less
- Heavy-duty rating (075H and larger), Normal-duty Capacity that is 10-times or less inverter capacity

If the above values are exceeded, install an ACL on the inverter's input side. (Refer to Table 7-1-b.)

2. Installation and Wiring

(Note 7) Noise measures

The inverter will generate high harmonic electromagnetic noise, so using the following noise measures is recommended.

- a) Insert a noise filter on the input side of the inverter. Refer to Table 7-1-b and select the noise filter. A unit with built-in noise filter is available as an option.
- b) Keep the length of the wire between the noise filter and inverter as short as possible, and keep it separate from the motor wiring.
- c) Use a shield cable for the inverter and motor wiring, and connect the shield to the inverter's \oplus terminal and motor grounding terminal.
Furthermore, refer to Table 2-3 for details of the wire size.
- d) When using the control circuit wiring explained in Section 2-4 and the main circuit wiring in this section in parallel, separate the wiring by 30cm or more, or pass each of the wiring through metal conduits. If the control circuit wiring and main circuit wiring intersect, make sure that they intersect at a right angle.

(Note 8) Inverter output

- a) Do not insert a power factor improvement capacitor on the output side of the inverter.
- b) When inserting a magnetic contactor on the output side of the inverter, prepare a sequence control circuit so that the magnetic contactor will not open and close when the inverter runs.
- c) Directly connect only the motor to the inverter load, and do not relay through a transformer, etc.

(Note 9) Grounding

Always ground the inverter unit grounding terminal and the ground. Ground according to the regulations of the country where the inverter is being used.

(Note 10) Inverter output surge voltage (For 400V series)

As the inverter output cable is lengthened, the surge voltage applied on the motor also increases. If the wiring between the inverter and motor exceeds 30m, connect a surge absorber dedicated for the inverter output.

(Note 11) DCL

Always short circuit across L+1 and L+2 when not using the DCL. (Factory setting state)

When connecting the optional DCL, connect it to L+1 and L+2.

Always remove the short-circuit bar at this time.

Twist the wiring to the DCL, and keep the wiring length to 5m or less.

(Note 12) DB unit (022L, 030H or more)

When connecting the optional DB unit, follow Fig. 2-3-a (b) (c) and connect the L+2 and L-.

The DB unit and inverter unit will both be damaged if the connection is incorrect.

Twist the wiring to the DB unit, and keep the wiring length to 3m or less.

Refer to Section 7-2 for details.

(Note 13) DBR protection

When using the optional DB unit, use the DB unit's overload detection relay or thermal relay (76D) to protect the DB resistor and inverter. Refer to section 7-3 for details.

(Note 14) Installation of surge absorber

Install a surge absorber on the magnetic contactor and relay coils installed near the inverter.

(Note 15) L- terminal

015L,018L,018H and 022H doesn't mount L- terminal.

2. Installation and Wiring

(a) OP7L to 011L
OP7H to 015H

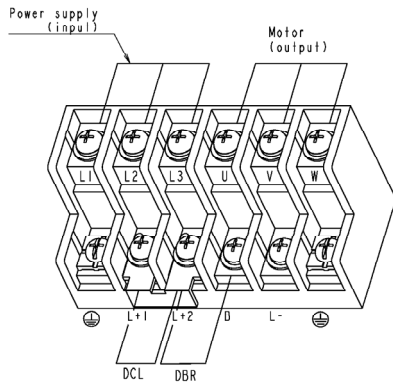

(b) 018H, 022H

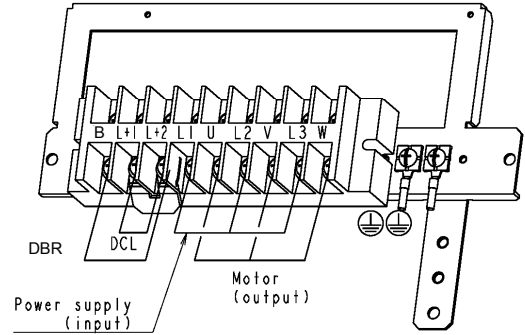

(c) 015L

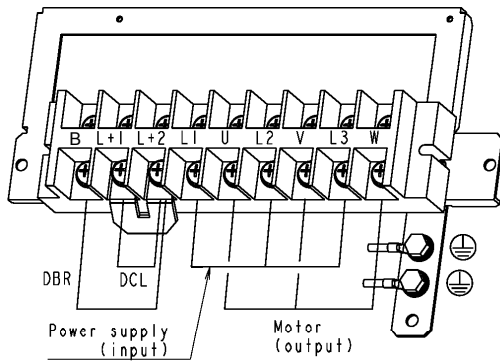

(d) 030H

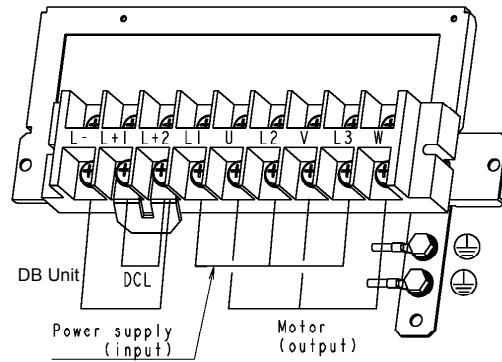

(e) 018L

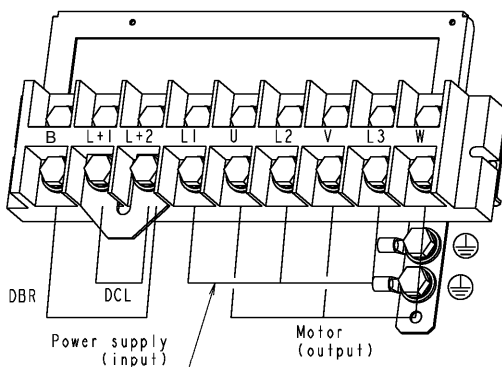
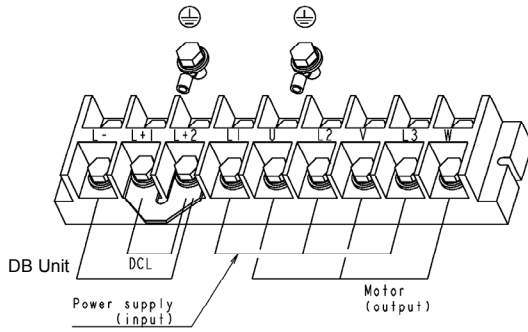

Fig. 2-3-b Terminal block wiring

2. Installation and Wiring

(f) 022L, 030L
037H to 055H



(g) 037L, 045L

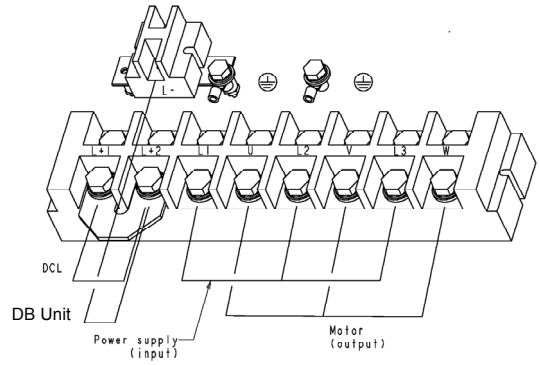

(h) 055L
075H, 090H

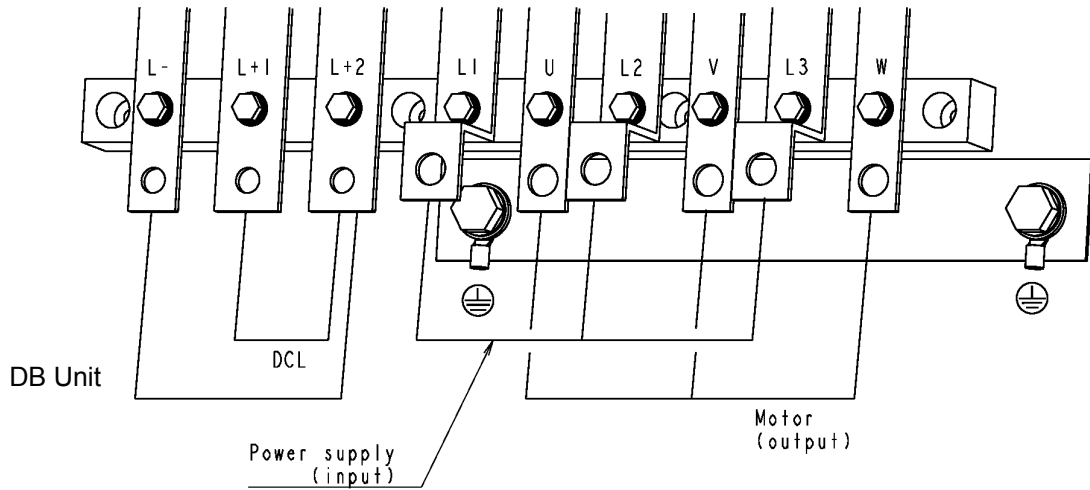

(i) 075L
110H, 132H

Fig. 2-3-b (cont.) Terminal block wiring

(j) 090L
160H, 200H

(k) 250H

(l) 315H to 475H

Fig. 2-3-b (cont.) Terminal block wiring

2-4 Precautions for wiring to the control signal

- (1) When wiring (control circuit wiring) to the control terminal block, separate the main circuit wiring (terminals L1, L2, L3, L+1, L+2, L-, B, U, V, W) and the other drive wires and power wires.
- (2) Use a 0.13 to 0.8mm² wire for wiring to the control circuit.
In this case, tighten TB1 and TB2 with a 0.6N·m tightening torque.
The TB3 tightening torque must be 0.25N·m.
- (3) The length of the sequence input/output contact wire must be 30m or less.
- (4) The sequence output PSO3 can output the pulse output (max.: 6kHz) by changing DS1-4 and setting the pulse output.
Note) Do not use the pulse output setting when you use speed detection PCB.
- (5) Use a twisted pair wire or twisted pair shield wire for wiring to the analog signal circuit such as the setters and meter. (Refer to Fig. 2-4-a.) Connect the shield wire to the TB1 COM terminal of the VT240S.
The wire length must be 30m or less.
- (6) The analog output is dedicated for the indicators such as the speedometer and ammeter.
It cannot be used for control signals such as the feedback control.
- (7) RY24 and RY0 are designed exclusively for the drive's internal sequence circuits.
These are not designed to supply power to any external devices.
- (8) After wiring, always check the mutual wiring.
At this time do not carry out a megger check or buzzer check on the control circuit.
 - Are there any wire scraps or foreign matter left around the terminals?
 - Are any screws loose?
 - Is the wiring correct?
 - Is any terminal contacting any other terminal?
 - Is the setting of the ell bit and the dip switch correct?

2. Installation and Wiring

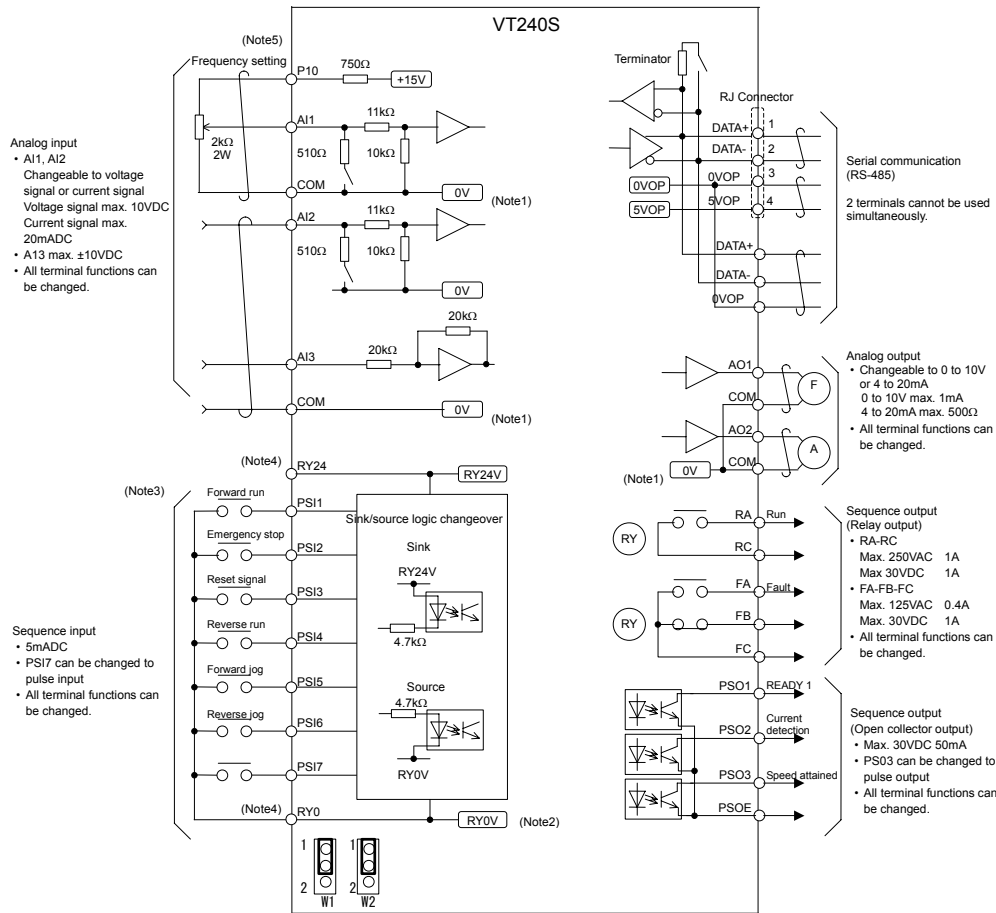

Fig. 2-4-a

(Notes)

1. Four COM terminals are internally connected.
2. No connection shall be made between RY0, COM and 0VOP since this section is insulated.
3. This diagram is an example of the sink logic connection.
4. RY24 and RY0 must not be shorted.
5. P10 and COM must not be shorted.

1) Control terminal

Fig. 2-4-b

- The terminal block is laid out in two rows.
- Terminal screw size is M3.

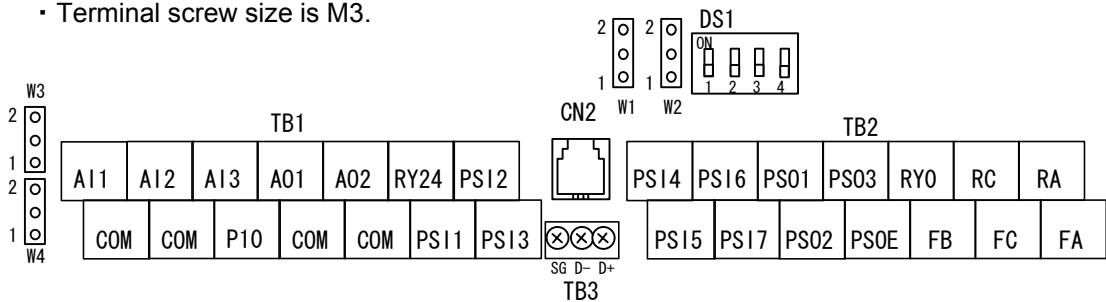

2) Dip switches DS1

Terminal No.	OFF	ON	Signal
1	OPEN	120Ω	Standard serial terminator changeover
2	V1	I1	AI1 current, voltage changeover
3	V2	I2	AI2 current, voltage changeover
4	PS03	PULSE	Pulse train output, sequence output changeover

All switches are set to OFF as the default.

2. Installation and Wiring

3) Ell bits W1,W2,W3,W4

Terminal No.	1	2	Signal
W1	SINK	SOURCE	PSI1~6 sink, source changeovers
W2	SINK	SOURCE	PSI7 sink, source changeover
W3	voltage	current	AO1 current, voltage changeover
W4	voltage	current	AO2 current, voltage changeover

All switches are set to OFF as the default.

4) Standard serial transmission CN2 (model : Modular)

- A signal level is based RS-485. The terminus resistance (120Ω) can set up on/off in DS1-1. ((DS1-1=120Ω): Connected, (DS1-1=OPEN): Not connected)
- The direction of a signal is based on VT240S.

Terminal No.	Signal
1	DATA+
2	DATA-
3	0V0P
4	5V0P

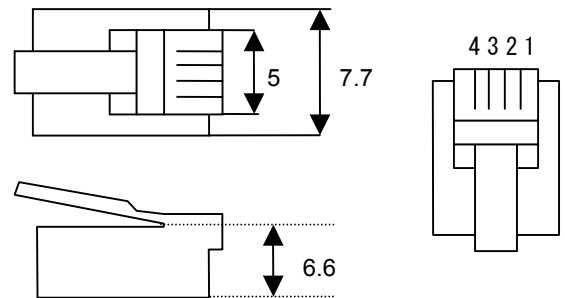

Outline drawing of connector

5) Standard serial transmission TB3

- CN2 and TB3 DATA+, DATA- and OVP are connected in the PCB.
- The terminal size is M2.

Terminal No.	Symbol	Signal
1	D+	DATA+
2	D-	DATA-
3	SG	0VP

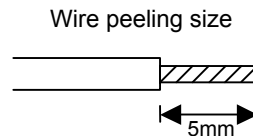

Notes for moving Operation panel folder

Do not raise the operation panel folder with an angle of larger than 70°, so that the folder should not be fallen off.

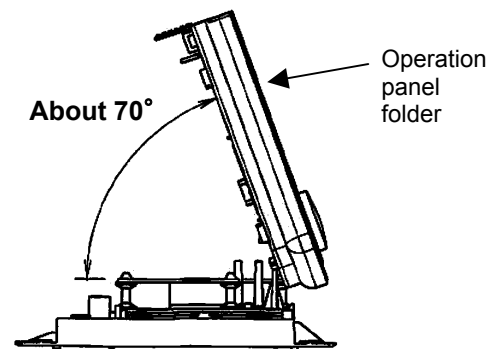

If the operation panel folder should be taken off, push the hinges of the folder lightly and insert them into the original positions.

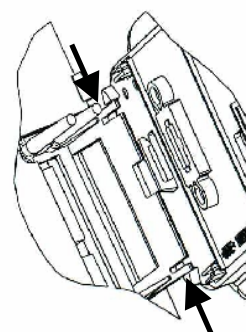

Chapter 3 Test Operation and Adjustment



- Always install the front cover before turning the input power ON. Never remove the cover while the power is ON. There are sections in the front PCB that are charged with high voltages. Failure to observe this could lead to electric shocks.
- Never touch the switches with wet hands. Failure to observe this could lead to electric shocks.
- Never touch the inverter's terminals while the inverter power is ON even if the operation is stopped. Failure to observe this could lead to electric shocks.
- Selection of the retry function could lead to unexpected restarting when alarm stops. The machine may start suddenly if the power is turned ON when the automatic start function is selected. Do not go near the machine.
(Design the machine so that physical safety can be ensured even if the machine restarts.) Failure to do so could lead to injuries.
- The machine may not stop when a stop command is issued if the deceleration stop function is selected and the overvoltage/overcurrent limit function is activated. Prepare a separate emergency stop switch. Failure to do so could lead to injuries.
- The unit will not suddenly restart even if the alarm is reset with the operation signal input, however, in order to prevent unexpected operation, ensure that the operation signal is no longer being input, and reset the alarm. Failure to do so could lead to injuries.



- The heat sink and resistor are heated to high temperatures, so never touch them. Failure to observe this could lead to burns.
- Do not block the inverter's ventilation holes. Failure to observe this could lead to fires.
- The inverter operation can easily be set from low speeds to high speeds, so confirm that the operation is within the tolerable range for the motor or machine before making settings. Failure to do so could lead to injuries.
- Prepare holding brakes when necessary. Holding is not possible with the inverter's brake functions. Failure to do so could lead to injuries.
- Confirm the operation of the motor as a single unit before operating the machine. Failure to do so could lead to injuries or machine damage due to unforeseen movements. Always prepare a safety backup device so that the machine is not placed in a hazardous situation when an error occurs in the inverter. Failure to do so could lead to injuries or machine damage or fires.
- When using the 400V Series (075H or higher) set the power changeover connector on the transformer auxiliary PCB according to the power voltage. Failure to do so could lead to fires.

3. Test Operation and Adjustment

The VT240S has various setting items. Some of these include settings that must be made according to the power supply and motor before actually starting operation.
The methods for the VT240S basic test operation and adjustment are explained in this section.

3-1 Flow of test operation

Carry out test operation according to the flow shown in Fig. 3-1.

The procedures above the dotted line in Fig. 3-1 are explained in this section.

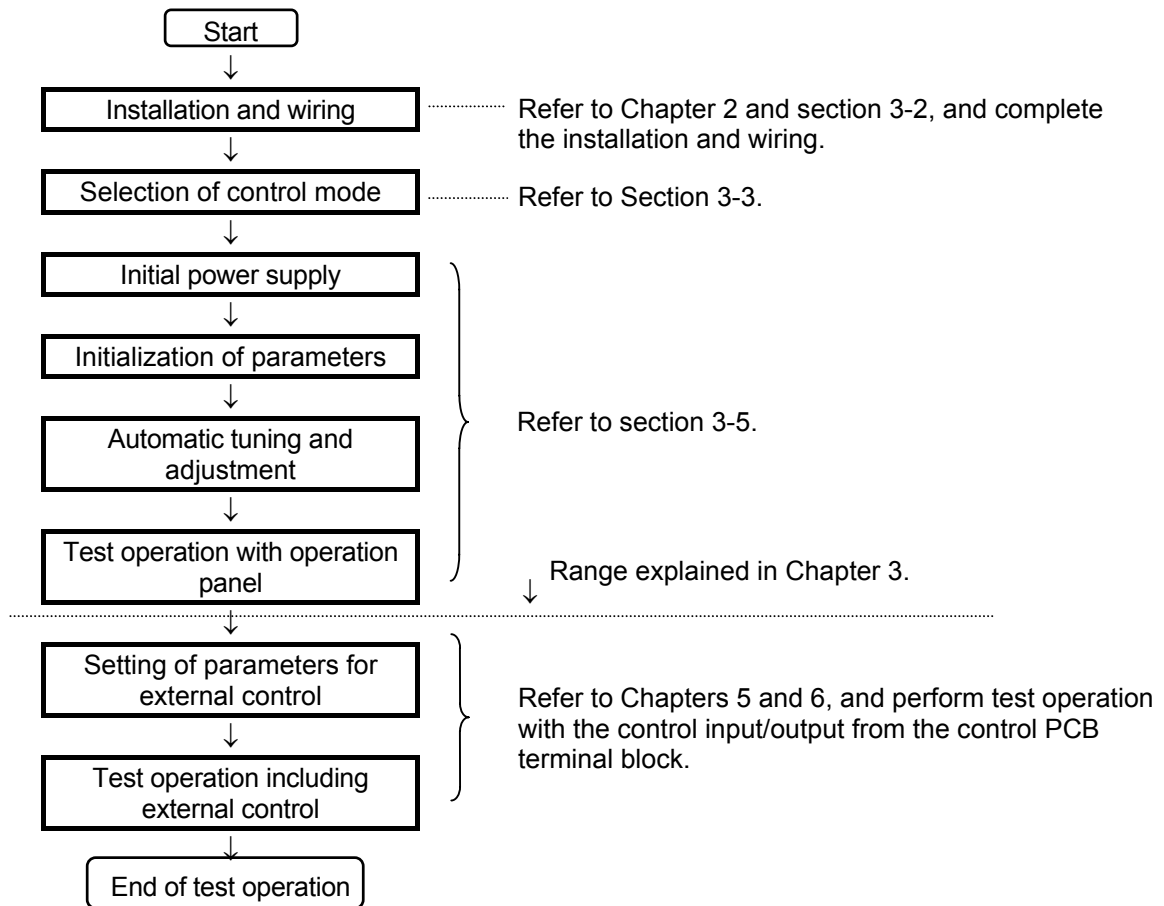

Fig. 3-1 Flow of test operation

CAUTION

- Check that the wiring is correct.
- The power supply must always be kept in the tolerable range.
- Confirm that the motor rating is within the inverter's rating range.
- Always correctly install the front cover before turning the power on.
- Assign one worker to operate the switches, etc.

3-2 Preparation before turning power ON

Always confirm the following points before turning ON the power after completing wire.

- (1) Remove the coupling and belt coupling the motor and machine, so that the machine can be run as a single unit.
- (2) Confirm that the power supply wire is correctly wired to the input terminals (L1, L2, L3).
- (3) With the 400V Series (075H or higher), there are some sections in the inverter which operate with an AC power supply, such as fan and magnetic contactor. In this case, set the power changeover connector on the transformer auxiliary PCB according to the power voltage.
If this connector is not set correctly, the fan and magnetic contactor could burn.

380V	: JP-380	440V	: JP-440
400V	: JP-400	460V	: JP-460
415V	: JP-415	480V	: JP-480 (factory setting)
- (4) Make sure that the power supply is within the tolerable range.
- (5) Refer to section 2-3, and correctly connect the main circuit wiring.
- (6) Securely fix the motor with the specified method.
- (7) Make sure that none of the terminal section screws are loose.
- (8) Make sure that there is no short circuit state in the terminals caused by wire scraps, etc.
- (9) Always correctly install the front cover and outer cover before turning the power ON.
- (10) Assign an operator, and make sure that the operator operates the switches.



CAUTION

Make sure that there is no abnormal noise, smoke or odors at this time.
If any abnormality is found, turn the power OFF immediately.

3-3 Control modes

With the VT240S, four control modes and two overload modes can be selected. These are set with the parameter C30-0 (control mode selection). Refer to the Appendix Table 1 Table of control specifications for details.

* C30-0 is set with a 2-digit value ($\overline{f0}$, $\overline{f1}$). Refer to section 3-4 for the setting methods.

(1) Control modes

There are four VT240S motor control modes. Refer to the following table, and select the mode which suits the application.

Control mode	Explanation	C30-0 $\overline{f0}$
1) V/f control	The voltage - frequency ratio is controlled.	1
2) IM speed sensor-less vector control	The IM is vector-controlled without a speed sensor. The speed can be controlled.	2
3) IM vector control with speed sensor	The IM is vector-controlled with a speed sensor. This mode is used when a fast speed response or torque response is required. The speed detection option 1 is required. (Note 1)	3
4) PM motor control with sensor	The PM motor is vector-controlled. The motor can be operated at a higher efficiency than IM. A speed detection option which matches the sensor (encoder) being used is required. (Note 1)	4

(Note 1) : Refer to Table 7-1-a (Chapter 7) for details on the speed detection options.

(2) Device overload mode selection

The following two modes can be selected according to the load being used. If the load and device capacity do not differ, the device could be overloaded. Refer to the following table, and select the mode that matches the load being used.

Control mode	Explanation	C30-0 $\overline{f1}$
1) Normal-duty setting	Select this when the maximum load rate in respect to the rated load is low. The overload standard will be 120% of the device's rated current for one minute.	1
2) Heavy-duty setting	Select this when the maximum load rate in respect to the rated load is high. The overload standard will be 150% of the device's rated current for one minute.	2

3-4 Automatic tuning and test operation

Automatic tuning measures the constants of the connected motor, and automatically adjusts the parameters so that the system is used to the fullest.

The VT240S automatic tuning function performs differ measurements for each of the four control modes. Carry out automatic tuning each time the motor being used or the applicable control mode is changed. The automatic tuning mode is set with parameter B19-0 (automatic tuning selection).

Control mode	Automatic tuning mode
• V/f control	B19-0 = 1,2
• IM speed sensor-less vector control	B19-0 = 3, 4, 5
• IM vector control with speed sensor	B19-0 = 1, 3, 4, 5
• PM motor control with sensor	B19-0 = 6, 7

B19-0	Name
1	Simple adjustment mode
2	V/f control high-function adjustment mode
3	Vector control basic adjustment mode
4	Vector control expanded adjustment mode
5	No-load voltage operation mode
6	Encoder phase adjustment mode (Note 1)
7	Magnetic pole position estimation mode (Note 2)

Carry out parameter initialization and automatic tuning as shown in the following flow chart. Refer to Chapter 4 for details on changing the parameters and operating the operation panel.

An adjustment mode dedicated for elevators (with brakes) is provided for the PM motor vector control with speed sensor. Refer to section 3-4-4 when using this mode for elevator applications. The automatic tuning function is not available in this case, so the parameters must be adjusted with the given procedures.

Refer to section 3-4-3 when using for applications other than elevators.

(Note 1) B19-0=6 : The encoder phase adjustment mode automatically adjusts the parameters which set the phase angle between the encoder Z phase pulses and PM motor U-phase coil. The motor circuit constants are not adjusted automatically.

(Note 2) B19-0=7 : The magnetic pole position estimation mode is used to adjust the PM motor control magnetic pole position estimation function. This mode does not automatically adjust the parameters.

3. Test Operation and Adjustment

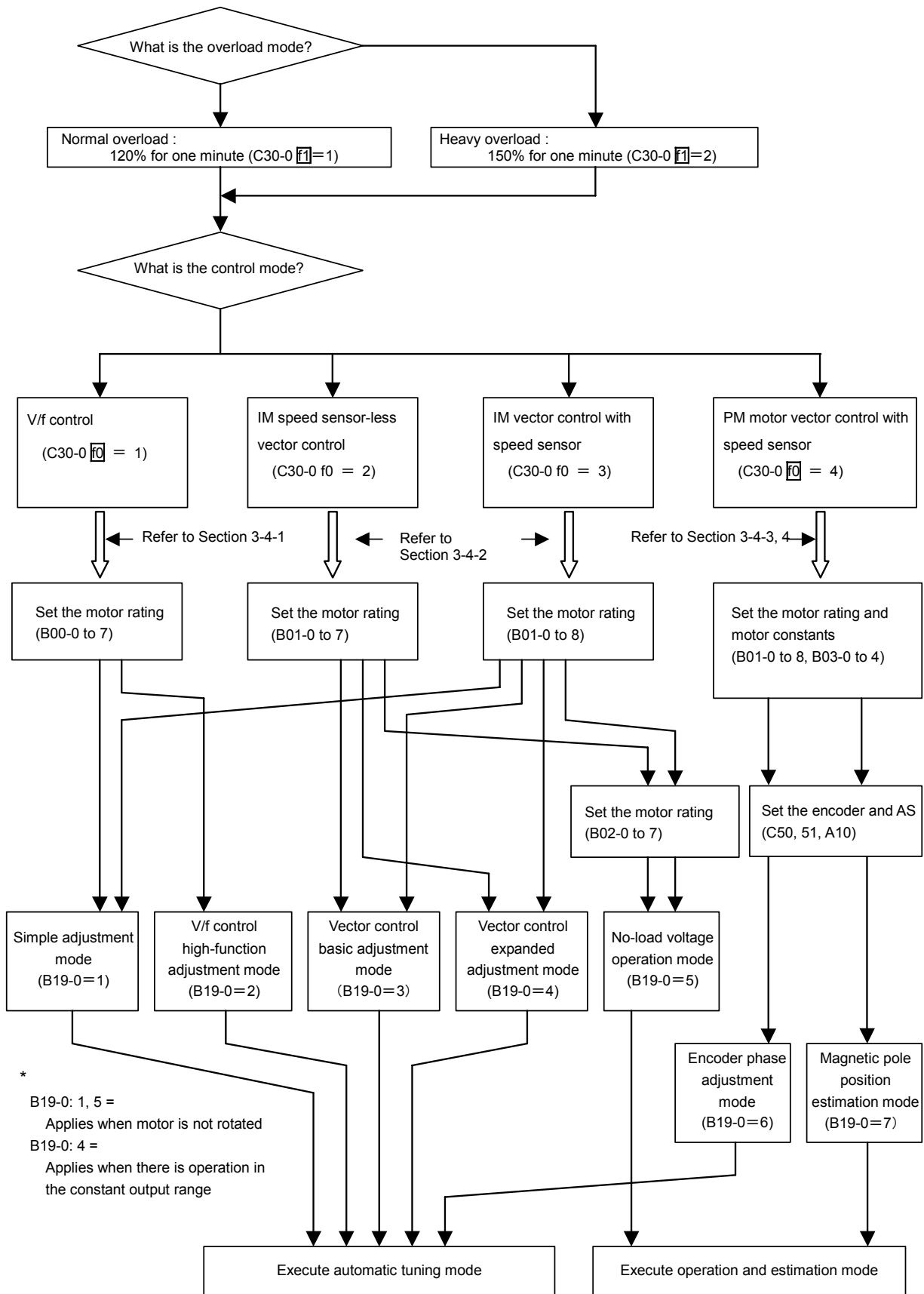

Fig. 3-4 Selection of automatic tuning mode

3-4-1 V/f control (C30-0 f_0 = 1) automatic tuning and test operation

(1) Automatic tuning (V/f control mode)

The following two modes can be selected for the V/f control automatic tuning.

Using B19-0 (automatic tuning selection), select the automatic tuning mode that matches the working conditions.

- 1) B19-0 = 1: Mode 1: simple adjustment mode (Execution time: approx. 10 seconds)

The basic parameters, such as boost voltage and brake voltage, are adjusted without rotating the motor.

The following parameters shown in Table 3-4-1-a are automatically adjusted by executing Mode 1.

Table 3-4-1-a

Applicable mode	Parameter No.	Name
C30-0 f_0 = 1 B19-0 = 1	A02-2	Manual torque boost setting
	A03-0	DC brake voltage
	B02-0, 1	R1: Primary resistance
	B02-4, 5	L σ : Leakage inductance

- 2) B19-0 = 2: Mode 2: V/f control high-function adjustment mode (Execution time: approx. 1 minute)

The parameters related to the slip compensation and max. torque boost are adjusted while rotating the motor.

The magnetic saturation characteristics are measured at the voltage boost, and are adjusted to match the max. torque boost.

The following parameters shown in Table 3-4-1-b are automatically adjusted by executing Mode 2.

Table 3-4-1-b

Applicable mode	Parameter No.	Name
C30-0 f_0 = 1 B19-0 = 2	A02-2	Manual torque boost setting
	A03-0	DC brake voltage
	B02-0, 1	R1: Primary resistance
	B02-4, 5	L σ : Leakage inductance
	A02-5	Slip compensation gain
	A02-6	Max. torque boost gain

(Note 1) When the V/f control mode (C30-0 f_0 = 1) is selected, modes other than B19-0=1, 2 cannot be used. If B19-0 is set incorrectly, set it again.

(Note 2) If the base frequency of the motor is applied on a motor exceeding 120Hz, select Mode 1 (B19-0 = 1). Adjust the slip compensation gain (A02-5) and max. torque boost gain (A02-6) manually.



CAUTION

Precautions for executing V/f control automatic tuning

- Even when Mode 1 is executed, the motor may rotate due to vibration, etc.
- If the vibration is large, turn the  key immediately to stop operation.
- With Mode 2, the motor will automatically start rotating.
- Always check the safety on the load side before executing automatic tuning, regardless of the Mode 1 or 2 setting.
- During automatic tuning, the motor may rotate, so always confirm safety before starting automatic tuning.
- If the automatic tuning function does not end correctly, always turn the inverter power OFF before investigating or confirming the operation.
- Automatic tuning can be started only in the local operation mode (when "LCL" LED on operation panel is ON). Confirm that the "LCL" LED is ON.
- If the motor has an unstable frequency band, automatic tuning may not end normally. In this case, the maximum torque boost function cannot be used.
- If the load is less than 30% and the fluctuation does not occur, automatic tuning can be carried out with the load and machine connected. However, the performance may not be complete.
- Always carry out automatic tuning before using the maximum torque boost function.
- The contact output FLT will function if the automatic tuning does not end correctly. In equipment that uses this contact, keep the operation of the related devices in mind.

3. Test Operation and Adjustment

(2) Automatic tuning operation procedures (V/f control mode)

Carry out V/f mode automatic tuning with the following procedures.
Refer to Chapter 4 for details on using the operation panel.

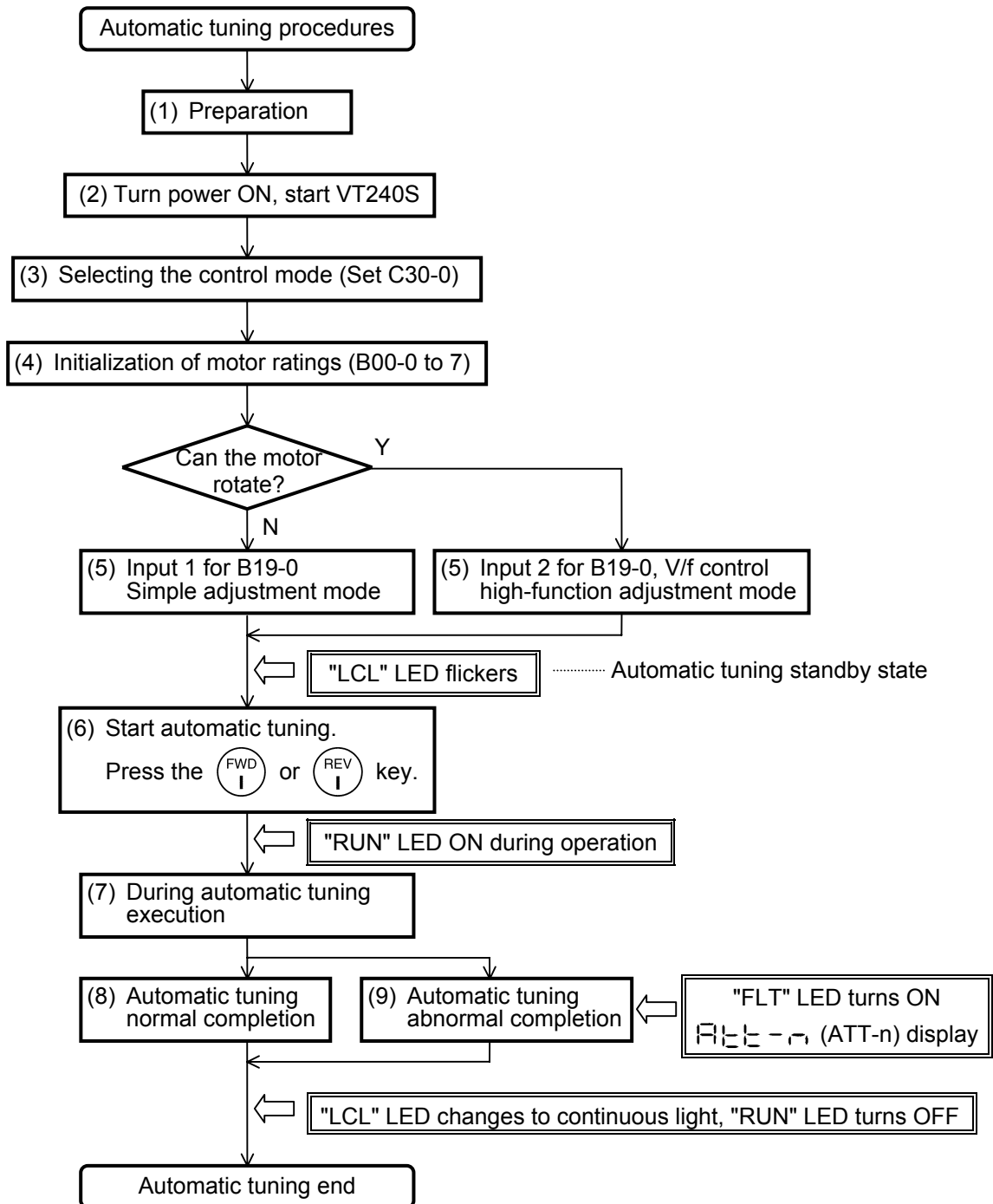

Fig. 3-4-1 V/f control automatic tuning procedures

3. Test Operation and Adjustment

1) Preparation

Separate the motor and load, machine, etc., and confirm the safety on the load side.

2) Turning the power ON and starting VT240S (In the case of V24-OP2)

Turn the power ON.

All LEDs on the numeric display will turn ON for a short time, and then "-----", "000-0" and "OFF" will appear. The "LCL" and "Hz" LEDs will also turn ON.



3) Selecting the control mode

- Set A05-2 to 1. (Set the hardware option function display ON.)

- Set the control mode selection: C30-0 $\boxed{f1} \boxed{f0}$.

This parameter must be set first. **(Note 1)**

V/f control mode is to be used, so set C30-0 $\boxed{f0}$ = 1.

Set c30-0 $\boxed{f1} \boxed{f0}$ as shown below according to the load.

Normal-duty setting: C30-0 $\boxed{f1} \boxed{f0}$ = 1 1

Heavy-duty setting: C30-0 $\boxed{f1} \boxed{f0}$ = 2 1

(Note 1) The default value is set to V/f control and Normal-duty setting (C30-0=11).

There are some parameters which will change automatically when C30-0 is changed, so also set this first.

4) Initialization of motor constants

Input the motor rating parameters. Set the parameters shown in Table 3-4-1-c. Automatic tuning will automatically change the parameters, so it is recommended to write down the values set in Table 3-4-1-a or Table 3-4-1-b.

Table 3-4-1-c

Applicable mode	Parameter No.	Name	
C30-0 $\boxed{f0}$ = 1 B19-0 = 1, 2	B00-0	Rated input voltage setting	[No.]
	B00-1	Max/base frequency simple setting	[Hz]
	B00-2	Motor rated output	[kW]
	B00-3	Rated output voltage	[V]
	B00-4	Max. frequency (Note 1)	[Hz]
	B00-5	Base frequency (Note 1)	[Hz]
	B00-6	Motor rated current	[A]
	B00-7	Carrier frequency	

(Note 1) The max. frequency cannot be set below the base frequency, and the base frequency cannot be set above the max. frequency.

5) Selecting and executing the automatic tuning mode

Select the automatic tuning mode and execute automatic tuning.

- The operation panel's operation mode must be set to "Local" to execute automatic tuning.

Make sure that the "LCL" LED is ON. If not, press the $\left(\frac{LCL}{SET}\right)$ + $\left(\frac{STOP}{O}\right)$ keys, and confirm that the "LCL" LED turns ON.

- Set A05-0 to 1. (Set the expanded setting display ON.)

- Using B19-0 (automatic tuning selection), select the automatic tuning mode according to the working conditions. Refer to section 3-4-1 (1) for details on the automatic tuning mode.



- The automatic tuning standby state will be entered when the $\left(\frac{LCL}{SET}\right)$ key is pressed.

- During the automatic tuning standby state and the automatic tuning execution state, the LCL LED will flicker.





- To exit the automatic tuning standby state, press the $\left(\frac{STOP}{O}\right)$ key.

3. Test Operation and Adjustment

6) Starting automatic tuning

Automatic tuning will start when the  key or  key is pressed according to the required rotation direction.

To stop, press the  key or input the emergency stop signal (EMS) from the terminal block.

* Once automatic tuning starts, all panel operations other than the ,  and   keys are disabled until the operation ends.

7) During automatic tuning execution

The progression state can be confirmed with D22-0.



Upper level: The steps required for tuning are indicated (lit).

Lower level: The finished steps are indicated (lit). The step currently being executed is indicated with a flicker.

8) Normal completion of automatic tuning

When the automatic tuning ends normally, the "LCL" LED will change from a flicker to a stable light. The "RUN" LED will change from a stable light to the OFF state. Refer to section 3-4-1 (1) for the adjustment items.

9) Abnormal completion of automatic tuning

If automatic tuning ends abnormally, the "FLT" LED will turn ON and a message will appear. Investigate and check according to the error codes. Refer to section 3-4-5 for details on the error codes.

(3) Test operation (V/f control mode)

When finished with automatic tuning, test run the isolated motor, and make sure that there are no errors.

Use the following procedures to test the operation with the operation panel.

Refer to Chapter 4 for details on using the operation panel.



CAUTION

To prevent incorrect operation during the test operation, make sure that signals are not input into the sequence input terminal.

1) To enable operation with the operation panel, confirm that the "LCL" LED is ON. If not, press the



keys, and confirm that the "LCL" LED turns ON.

2) Set speed setting input point selection: C02-0= 3 (panel fixed).







CAUTION

The motor will rotate with the next step.

Confirm the safety around the motor before starting the next step.

3. Test Operation and Adjustment

- 3) Press the  and display D000-0 on the monitor. Then press the  key. Operation will start.

The "FWD" lamp will turn ON, and the display will change from "  " to a value display. The value will gradually increase, and after several seconds, will change to "  ". This is because as the factory settings, the direct setting frequency (A00-0) is set to 10Hz and the acceleration ramp time 1 (A01-0) is set to 10sec.

CHECK

1. Did the motor run?
2. Is the run direction correct? Check the wiring and operation if abnormal.
3. Is the rotation smooth?

- 4) Press the  key and confirm that the motor runs in reverse.

(Note) Do not carry out this step if a load which cannot be run in reverse is connected.

- 5) Press the  key and stop the motor.



- 6) Press the  key. The motor will forward run at the output frequency 10Hz.



Change the frequency to 50Hz with the following operation.



- 7) Press the  key several times. The Display will alternate between "  " and "  ".

- 8) Press the  key once.

The display will stop at "  ", and the last digit will flicker.

This completes the preparation for changing the output frequency. The digit to change can be moved with the  key. The output frequency can be incremented/decremented with the   keys.



- 9) Move the digit with the  key, and using the  key, raise the frequency to 50.00Hz. Then, press the  key. The output frequency will rise to 50Hz.

(Note) The operation panel frequency change operation is set to be changed (C11-2=1) in real time at the factory shipment settings, and therefore the output frequency is changed in real time using the   keys, without having to press the  key.



When the  key is pressed, the current setting value will be saved.

CAUTION

A 10-second acceleration and 20-second deceleration ramp time are set as defaults. The motor will slowly increase its speed to the set value.

When making a setting (using the   keys), check that the motor operates correctly at each increment of approx. 10Hz.

3. Test Operation and Adjustment

10) Press the  key several times, and display D00-0. When the output frequency ("D00-0" display) reaches 50Hz, press the  key.

The display will decrease to "0.00" in several seconds. The "FWD" or "REV" LED will flicker for two seconds while the DC-brake is applied and the motor will stop.

11) Press the  key, and test the reverse run at 50Hz.

(Note) Do not carry out this step if a load which cannot be run in reverse is connected.

This completes the test operation with the operation panel.

After this, refer to Chapter 4 and carry out the settings and adjust the load operation to match the user's application.

3. Test Operation and Adjustment

3-4-2 IM speed sensor-less vector control (C30-0 f_0 = 2) and IM vector control with speed sensor (C30-0 f_0 = 3) automatic tuning test operation

(1) Before automatic tuning

When using IM vector control with speed sensor, the speed detection option is required in addition to the VT240S standard unit. Confirm that this option has been prepared.

(2) Automatic tuning (IM vector control mode)

The following four modes can be selected for the IM speed sensor-less vector control or IM vector control with speed sensor automatic tuning.

Using B19-0 (automatic tuning selection), select the automatic tuning mode according to the load conditions. **(Note 1)**

- 1) B19-0 = 1: Mode 1: simple adjustment mode (Execution time: approx. 10 seconds) **(Note 1)**
 The basic parameters for IM vector control with speed sensor are automatically adjusted without rotating the motor.
 The following parameters shown in Table 3-4-2-a are automatically adjusted by executing Mode 1.

Table 3-4-2-a

Applicable mode	Parameter No.	Name
C30-0 f_0 = 3 B19-0 = 1	B01-9	No-load output voltage
	B02-0, 1	R1 : Primary resistance
	B02-2, 3	R2' : Secondary resistance (Note 2)
	B02-4, 5	L_σ : Leakage inductance
	B02-6, 7	M' : Excitation inductance (Note 2)

- 2) B19-0 = 3: Mode 3: Vector control basic adjustment mode (Execution time: approx. 30 seconds)
 The motor is rotated and the basic parameters for vector control are automatically adjusted.
 The following parameters shown in Table 3-4-2-b are automatically adjusted by executing Mode 3.

Table 3-4-2-b

Applicable mode	Parameter No.	Name
C30-0 f_0 = 2, 3 B19-0 = 3	B01-9	No-load output voltage
	B02-0, 1	R1 : Primary resistance
	B02-2, 3	R2' : Secondary resistance
	B02-4, 5	L_σ : Leakage inductance
	B02-6, 7	M' : Excitation inductance

- 3) B19-0 = 4: Mode 4: Vector control extended adjustment mode (Execution time: approx. 1 minute)
 This mode is selected to carry out constant output range operation.
 The following parameters shown in Table 3-4-2-c are automatically adjusted by executing Mode 4.

Table 3-4-2-c

Applicable mode	Parameter No.	Name
C30-0 f_0 = 2, 3 B19-0 = 4	B01-9	No-load output voltage
	B02-0, 1	R1 : Primary resistance
	B02-2, 3	R2' : Secondary resistance
	B02-4, 5	L_σ : Leakage inductance
	B02-6, 7	M' : Excitation inductance
	B33-0 to 7	M variable reference speed table
	B34-0 to 7	M variable compensation table

* When carrying out constant output operation, the fluctuation compensation for the excitation inductance is adjusted in this mode, however, the motor will rotate to the maximum speed during automatic tuning, so special attention must be paid to safety.

3. Test Operation and Adjustment

- 4) B19-0=5: Mode 5: No-load voltage operation mode (Execution time; approx. 10 seconds) **(Note 3)**

When the motor cannot be rotated with IM speed sensor-less vector control, this mode can be used to operate the motor's no-load voltage and complete automatic adjustment. The parameters shown in Table 3-4-2-d are automatically adjusted.

Table 3-4-2-d

Applicable mode	Parameter No.	Name
C30-0 $f_0 = 2$ B19-0 = 5	B01-9	No-load output voltage

The motor circuit constants cannot be automatically adjusted in this mode. The motor circuit constant parameters shown in Table 3-4-2-e must be set before automatic tuning. Refer to the motor design documents and calculate and set these parameters.

Table 3-4-2-e

Parameter No.	Name
B02-0, 1	R1 : Primary resistance
B02-2, 3	R2' : Secondary resistance
B02-4, 5	$L\sigma$: Leakage inductance
B02-6, 7	M' : Excitation inductance
B02-8, 9	Rm: Iron loss resistance

(Note 1) In the IM vector control mode (C30-0 $f_0 = 2, 3$), modes other than B19-0=1, 3, 4 or 5 cannot be used. If B19-0 is set incorrectly, set it again. When using IM speed sensor-less vector control, the simple adjustment mode (mode 1) cannot be used.

(Note 2) In the simple adjustment mode (mode 1), the excitation inductance is estimated using the motor rated value, so there could be an error in the output voltage. The output torque error is large in this state, so after executing automatic tuning, always carry out rated speed operation with a load of 30% or less, and adjust B02-6, 7 (excitation inductance) so that B01-9 (no-load output voltage) and the output voltage (D03-1) match. In addition, rated speed operation must be carried out at a 100% load, and B02-2, 3 (secondary resistance) adjusted so that the rated voltage (B01-3) and output voltage (D03-1) match.

(Note 3) The mode 5 automatic tuning can be executed even in the IM vector control with speed sensor, but the parameters shown in Table 3-4-2-d can be measured even in mode 1. Use mode 1 when using IM vector control with speed sensor.



CAUTION

Precautions for executing IM speed sensor-less vector control or IM vector control with speed sensor automatic tuning

- Always check the safety around the motor before starting automatic tuning.
- The motor could vibrate or start running.
The motor will automatically start rotating during automatic tuning.
- If the vibration is large during automatic tuning, press the  key immediately and stop the operation.
- Separate the motor from the load and machine, etc., and carry out automatic tuning with the isolated motor.
Automatic tuning can be performed when a non-fluctuating load of 10% or less or a machine is connected, but the accuracy will be poor so sufficient performance may not be attained.
- The contact output FLT will function if the automatic tuning does not end correctly.
In equipment that uses this contact, keep the operation of the related devices in mind.
- Automatic tuning cannot be used if the load is 10% or more or if the load fluctuates.
Refer to the motor documents, and input the R1: primary resistance, R2': secondary resistance, $L\sigma$: leakage inductance and M': excitation inductance and then execute B19-0=5 automatic tuning. The no-load voltage (B01-9) will be set automatically and operation with vector control will be possible. (Refer to section 6-6 Function explanation [B02-0 to 9](#) Motor circuit constants for details on calculating R2', $L\sigma$ and M'.)
- If the automatic tuning function does not end correctly, always turn the inverter power OFF before investigating or confirming the operation.

(3) Automatic tuning operation procedures (IM vector control mode)

Carry out automatic tuning with the following procedures.
Refer to Chapter 4 for details on using the operation panel.

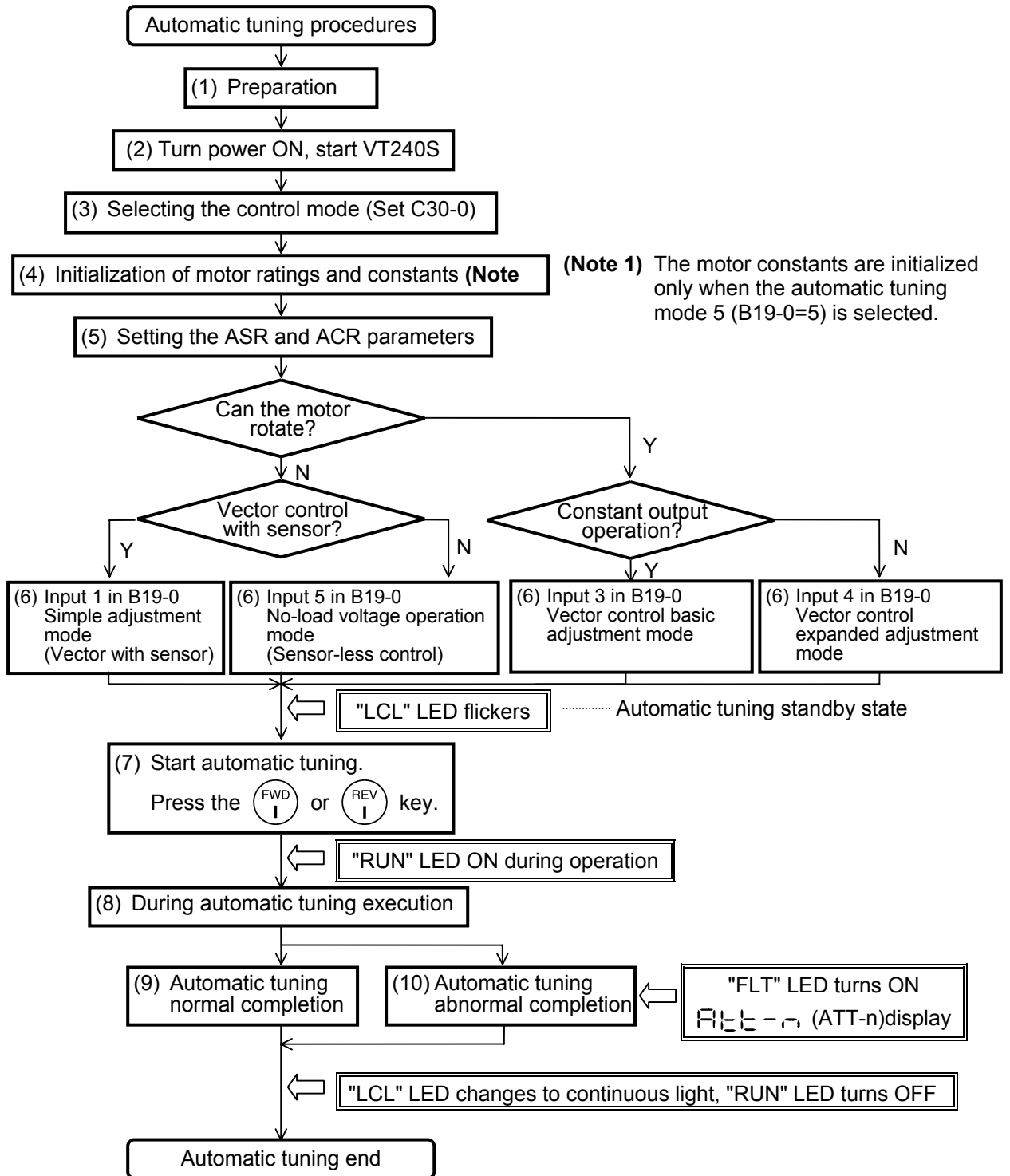

Fig. 3-4-2 IM speed sensor-less vector control and IM vector control with speed sensor automatic tuning procedures

3. Test Operation and Adjustment

1) Preparation

Separate the motor and load, machine, etc., and confirm the safety on the load side.
When using the IM vector control with speed sensor mode, make sure that the speed detection option PCB is correctly mounted on the control PCB, and that the encoder signal cable is correctly connected to the speed detection option.

2) Turning the power ON and starting VT240S (In the case of V24-OP2)

Turn the power ON.

All LEDs on the numeric display will turn ON for a short time, and then "-----", "000-0" and "off" will appear. The "LCL" and "Hz" LEDs will also turn ON.



(Note) When the power is turned ON next (after setting C30-0 f_0 = 2, 3), "000-2" will appear on the numeric display, and the "Hz" LED will not turn ON. This is because the mode is set to the IM vector control mode.

3) Selecting the control mode

- Set A05-2 to 1. (Set the hardware option function display ON.)
- Set the control mode selection: C30-0 f_1 f_0 .
This parameter must be set first. **(Note 1)**

	Normal-duty setting	Heavy-duty setting
IM speed sensor-less vector control	C30-0 = 1 2	C30-0 = 2 2
IM vector control with speed sensor	C30-0 = 1 3	C30-0 = 2 3

(Note 1) The default value is set to V/f control and Normal-duty setting (C30-0=11), so always change C30-0.
There are some parameters which will change automatically when C30-0 is changed, so also set this first.

4) Initialization of motor ratings and constants

Input the motor rating parameters. Set the parameters shown in Table 3-4-2-f. Automatic tuning automatically changes the parameters, so the setting value shown in Table 3-4-2-a to d should be written down according to the automatic tuning mode being used.

Table 3-4-2-f

Parameter No.	Name	
B01-0	Rated input voltage setting	[No.]
B01-1	Motor rated output	[kW]
B01-2	No. of motor poles	[Pole]
B01-3	Rated output voltage	[V]
B01-4	Max. speed	[min ⁻¹]
B01-5	Base speed	[min ⁻¹]
B01-6	Motor rated current	[A]
B01-7	Carrier frequency	
B01-8	No. of encoder pulses	[P/R] : (Note 1)

* The max. speed cannot be set below the base speed, and the base speed cannot be set above the max. speed.

(Note 1) Always input B01-8 when using the vector control mode with speed sensor.

3. Test Operation and Adjustment

Set the motor circuit constant parameters shown in Table 3-4-2-g only when using the automatic tuning mode 5. Refer to the motor design documents and calculate and set these parameters.

Table 3-4-2-g

Parameter No.	Name
B02-0, 1	R1 : Primary resistance
B02-2, 3	R2' : Secondary resistance
B02-4, 5	L σ : Leakage inductance
B02-6, 7	M' : Excitation inductance
B02-8, 9	Rm : Iron loss resistance

5) Setting the ASR and ACR parameters

When performing automatic tuning, do not change the ASR (speed control) and ACR (current control) parameters shown in Table 3-4-2-h from the default values. Note that A10-1 must be set to the value obtained with the following expression.

Table 3-4-2-h

Parameter No.	Name	Standard value
A10-0	ASR response	10.0 [rad/s]
A10-1	Machine time constant	1000 [s]
A10-2	Integral time constant compensation coefficient	100 [%]
A10-3	ASR drive torque limiter	100 [%]
A10-4	ASR regenerative torque limiter	100 [%]
A11-0	ACR response	1000 [rad/s]
A11-1	ACR time constant	20.0 [ms]

Use the following expression and set A10-1: machine time constant according to the inertia of the isolated PM motor being used. The machine time constant (Tm) refers to the time required to accelerate to the base rotation speed from the zero speed at the rated torque.

$$T_m [\text{ms}] = 10.97 \times J [\text{kg}\cdot\text{m}^2] \times (\text{Nbase} [\text{min}^{-1}])^2 / \text{Power}[\text{W}]$$

J : Total inertia [kg·m²] (= 1/4 × GD² [kg·m²])



Nbase : Base rotation speed [min⁻¹]



Power : Motor rated output [W]

6) Selecting and executing the automatic tuning mode



Select the automatic tuning mode and execute automatic tuning.

- The operation panel's operation mode must be set to "Local" to execute automatic tuning.





Make sure that the "LCL" LED is ON. If not, press the  +  keys, and confirm that the "LCL" LED turns ON.

- Set A05-0 to 1. (Set the expanded setting display ON.)
- Using B19-0 (automatic tuning selection), select the automatic tuning mode according to the working conditions. Refer to section 3-4-2 (2) for details on the automatic tuning mode.
- The automatic tuning standby state will be entered when the  key is pressed.
- During the automatic tuning standby state and the automatic tuning execution state, the "LCL" LED will flicker.
- To exit the automatic tuning standby state, press the  key.

7) Starting automatic tuning

Automatic tuning will start when the  key or  key is pressed according to the required rotation direction.

To stop, press the  key or input the emergency stop signal (EMS) from the terminal block.

* Once automatic tuning starts, all panel operations other than the ,  and   keys are disabled until the operation ends.

8) During automatic tuning execution

The progression state can be confirmed with D22-0.



Upper level: The steps required for tuning are indicated (lit).

Lower level: The finished steps are indicated (lit).
The step currently being executed is indicated with a flicker.

9) Normal completion of automatic tuning

When the automatic tuning ends normally, the "LCL" LED will change from a flicker to a stable light. The "RUN" LED will change from a flicker to the OFF state.
Refer to section 3-4-2 (2) for the automatically adjusted items.

10) Abnormal completion of automatic tuning

If automatic tuning ends abnormally, the "FLT" LED will turn ON and a message will appear.
Investigate and check according to the error codes.
Refer to section 3-4-5 for details on the error codes.

3. Test Operation and Adjustment

(4) Setting the encoder parameter (IM vector control with sensor mode)

Set the encoder only when using the IM vector control with speed sensor mode (C30-0 f0 =3). The parameters to be set are listed in Table 3-4-2-i. IM vector control with speed sensor mode

Table 3-4-2-i

Parameter No.	Name
C50-1	2-phase, 1-phase encoder selection
C50-2	Encoder AB phase advance direction

1) C50-1: 2-phase, 1-phase encoder selection

Set the number of signals (2-phase, 1-phase) of the encoder to be used.

C50-1=1: Select this for an encoder which outputs a 2-phase signal (A, B phase) which has a 90° phase difference.

The rotation direction can be judged, and stable speed control can be realized even at low speeds.

C50-1=2: Select this when using an encoder which outputs a 1-phase signal.

Connect the input signal to the A or B phase input, and leave the other phase unconnected. The 1-phase pulse signal validates functions which convert into 2-phase signals.

In the 1-phase signal mode, the rotation direction is recognized as the operation command direction. Forward run and reverse run cannot be determined.

In low-speed ranges, the speed detection error may occur because of chattering. When using low-speed operation or forward/reverse operation, use the 2-phase encoder.

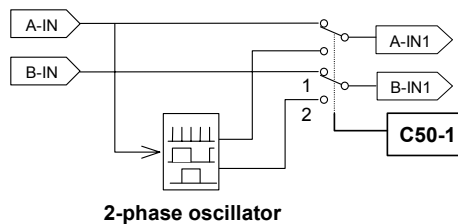

(Note 1) When 1-phase input is selected, the speed detection direction (sign) is determined by the operation direction.

(Note 2) When 1-phase input is selected and ACR control is being conducted with IM vector control with speed sensor, the direction is recognized with the rotation direction indicated in (Note 1). Pay attention to the acceleration direction.

2) C50-2: Encoder AB phase advance direction selection

The motor's rotation direction is judged by the encoder A, B phase pulse phase advance and delay. Refer to the following figure and set this parameter according to the relation of the encoder AB phase signal phase relation during forward run (CCW rotation).

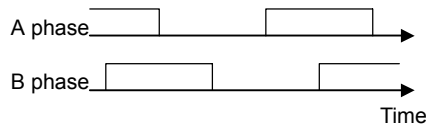

(a) When C50-2=1 (during CCW rotation)

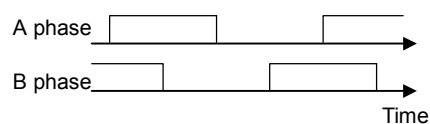

(b) When C50-2=2 (during CCW rotation)

3. Test Operation and Adjustment

(5) Test operation (IM vector control mode)

When finished with steps (1) to (4), test the isolated motor and check for abnormalities.

In the following cases, basic manual adjustment (refer to section (6) steps 1) and 2)) must be completed before starting the test.

- When automatic tuning is executed with the B19-0=1 mode (simple adjustment mode)
- When IM speed sensor-less vector control (C30-0 $\overline{f_0}$ = 2) mode is selected.

The procedures for test operation using the operation panel are explained below.

Refer to Chapter 4 for details on using the operation panel.



CAUTION

To prevent incorrect operation during the test operation, make sure that signals are not input into the sequence input terminal.

- 1) To enable operation with the operation panel, confirm that the "LCL" LED is ON. If not, press the





+ keys, and confirm that the "LCL" LED turns ON.

- 2) Set speed setting input point selection: C02-0= 3 (panel fixed).



CAUTION

- The motor will rotate with the next step.
Confirm the safety around the motor before starting the next step.
- The moment of inertia differs for isolated motor operation and load (machine) operation. Set the machine time constants (A10-1) according to the motor and load. The motor will vibrate if the settings are too high.

- 3) Press the  and display D00-2 on the monitor. Then press the  key.

The "FWD" lamp will turn ON, and the display will change from "OFF" to a value display. The value will gradually increase, and after several seconds, will change to "300.0". This is because as the factory settings, the direct setting frequency (A00-2) is set to 300min^{-1} and the acceleration ramp time -1 (A01-0) is set to 10sec.

CHECK

1. Did the motor run?
2. Is the run direction correct? Check the wiring and operation if abnormal.
3. Is the rotation smooth?

- 4) Press the  key and confirm that the motor runs in reverse.

(Note) Do not carry out this step if a load which cannot be run in reverse is connected.

- 5) Press the  key and stop the motor.

- 6) Press the  key. The motor will forward run at 300min^{-1} .



Change the frequency to 600min^{-1} with the following operation.



3. Test Operation and Adjustment

7) Press the  key several times. The Display will alternate between "800.2" and "300.0".



8) Press the  key once.

The display will stop at "300.0", and the last digit will flicker.

This completes preparation for changing the motor speed. The digit to be changed can be moved with the  key. The speed can be increased or lowered with the   keys.

9) Move the digit with the  key, and using the  key, raise the frequency to "600.0"min⁻¹.



Then, press the  key. The motor speed will gradually increase to 600min⁻¹.

(Note) The operation panel frequency change operation is set to be changed (C11-2=1) in real time at the factory shipment settings, and therefore the output frequency is changed in real time using the   keys, without having to press the  key.

When the  key is pressed, the current setting value will be saved.

CAUTION

A 10-second acceleration and 20-second deceleration ramp time are set as defaults. The motor will slowly increase its speed to the set value.

When making a setting (using the   keys), check that the motor operates correctly at each increment of approx. 10Hz.

10) When the motor speed (D00-2 display) increases to 600min⁻¹, press the  key.

The display will decrease to "0.0" in several seconds. The "FWD" or "REV" LED will flicker for two seconds while the DC-brake is applied and the motor will stop.

11) Press the  key, and test the reverse run at the maximum speed.

(Note) Do not carry out this step if a load which cannot be run in reverse is connected.

This completes the test operation with the operation panel.

(6) Basic manual adjustment (IM vector control mode)

1) Adjusting the exciting inductance when performing automatic tuning with B19-0=1 (Carried out with isolated IM)

- When there is no constant output range

In addition to automatic tuning in the simple adjustment mode (B19-0=1), the excitation inductance (B02-6, 7) must be adjusted. Run the motor at the base speed with no load, and adjust B02-6, 7 so that the no-load output voltage (B01-9) attained with automatic tuning and the output voltage (monitor D03-1 if measurement with rectified voltmeter is difficult) approximately match. In the same manner, the motor must be run at the base speed with 100% load, and the secondary resistance (B02-2, 3) adjusted so that the rated voltage (B01-3) and output voltage (monitor D03-1 if measurement with rectified voltmeter is difficult) approximately match. If the setting value of secondary resistance (B02-2,3) is made to increase during operation, output voltage will decrease. Moreover, if the setting value of secondary resistance (B02-2,3) is made to decrease during operation, output voltage will increase.

3. Test Operation and Adjustment

- When there is a constant output range
When running with a constant output range, the M fluctuation compensation must be adjusted. Set the speed table (B33-0 to 7) beforehand. The speed table should be set as shown below except in special cases.

Parameter No.	Recommended setting values
B33-0	$B33-1 \times (1/2)$
B33-1	Base speed : Same setting value as B01-5
B33-2	Set so that B33-1 to B33-7 are at an equal pitch
B33-3	
B33-4	
B33-5	
B33-6	
B33-7	Maximum speed : Same setting value as B01-4

Run the motor at the base speed with no load, and adjust B02-6, 7 so that the no-load output voltage (B01-9) attained with automatic tuning and the output voltage (monitor D03-1 if measurement with rectifying voltmeter is difficult) approximately match. The motor must be run at the base speed with 100% load, and the secondary resistance (B02-2, 3) adjusted so that the rated voltage (B01-3) and output voltage (monitor D03-1 if measurement with rectified voltmeter is difficult) approximately match. In the same manner, adjust the M fluctuation compensation coefficient (B34-2 to 7) so that the output voltage matches the no-load voltage (B01-9) at each speed in B33-2 to 7. B34-0, 1 is the M fluctuation compensation coefficient at the B33-0, 1 speed, and normally is approx. 100%. This does not need to be adjusted except in special cases.

* If manual adjustment is difficult after the simple adjustment mode, execute automatic tuning with the automatic tuning mode 3, 4 (B19-0=3, 4). Note that the motor will rotate in this mode.

- 2) Adjusting the IM speed sensor-less vector control (when C30-0 $\overline{f_0}$ = 2 mode is selected)
When using IM speed sensor-less vector control, the following items must be adjusted.

- Adjusting the ASR response

The ASR control response must be set to approx. 5rad/s for IM speed sensor-less vector control. Adjust ASR response (A10-0) to below the default value. Refer to section (3) for details on adjusting this item.

- Finely adjusting the primary resistance

Carry out test operation at the minimum speed to be used in the no-load (only inertial load) state, and finely adjust the primary resistance value. Adjust the primary resistance value (D02-0, 1) so that the speed amplifier output (D11-4) is approximately zero during forward run. Make sure that the output is not a negative value. In rare cases, if the output is a minus value, the operation may not stop because of the regenerative limiter (B31-3, 4, 5, 6).

(Note 1) The primary resistance value mantissa section (B02-0) can be changed during operation, but the B02-1 exponential section cannot be changed during operation.

- Finely adjusting the leakage inductance and exciting inductance

After automatic tuning, run the motor with a rated load at the motor's rated speed, and adjust the leakage inductance (B02-4, 5) and exciting inductance (B02-6, 7) so that the output voltage (D03-1) is approximately the same as the rated voltage. (If a rated load cannot be set, adjust so that the voltage matches the load.) If the output voltage drops during the load operation, increase the leakage inductance [mH] in increments of 10% (+ ΔL [mH]), and decrease the exciting inductance by - ΔL [mH]. If an overcurrent, etc., occurs in low-speed ranges after the above adjustment, decrease the above ΔL adjustment amount, or adjust the ACR response (A11-0, 1).

(Note 2) The B02-4 and B02-6 mantissa section can be changed during operation, but the B02-5, and B02-7 exponential section cannot be changed during operation.

- Adjusting the speed estimation

Confirm that the motor speed % display (D00-3) is stable ($\pm 1\%$ or less) during test operation. If not stable, adjust the speed estimation proportional gain (B31-1) and speed estimation integral gain (B31-2).

3. Test Operation and Adjustment

3) Adjusting ASR

Adjust the control parameters to match the user's system.

The main adjustment parameters are explained below.

- A10-0: ASR response : Set the speed control response with a [rad/s] unit.
If the speed tracking is slow, increase this value.
If this is set to high, the motor speed will hunt.
- A10-1: Machine time constant 1 : Set the time required to accelerate from zero to the base speed at the rated torque.

$$T_m [\text{ms}] = 10.97 \times J [\text{kg}\cdot\text{m}^2] \times (\text{Nbase}[\text{min}^{-1}])^2 / \text{Power} [\text{W}]$$

J : Total inertial [$\text{kg}\cdot\text{m}^2$] (= $1/4 \times \text{GD}^2 [\text{kg}\cdot\text{m}^2]$)

Nbase : Base speed [min^{-1}]

Power : Motor rated output [W]

- A10-2: Integral time constant compensation coefficient:
Increase the compensation coefficient if overshooting is large during speed control.
- A10-3: ASR drive torque limiter : Increase this value when drive torque is required.
- A10-4: ASR regenerative torque limiter:
Increase this value when regenerative torque is required.

Refer to Section 6-8 for details on adjusting these parameters.

(Note) When the test operation of the isolated motor is finished, the parameter A10-1: machine time constant setting is set to match the isolated motor's inertia. After connecting the motor to the load, always reset this parameter to match the inertia of the user's machine.

After this, refer to Chapter 4 and carry out the settings and adjust the load operation to match the user's application.

Refer to Section 6-8 for details on adjusting the vector control system parameters.

3-4-3 Automatic tuning and test operation for PM motor with sensor control (C30-0 f0=4)

CAUTION

Refer to Section 3-4-4 when driving a PM motor and the motor is locked with mechanical brakes when stopped together with the magnetic pole position estimation function.

(1) Before automatic tuning

When using the PM motor with sensor control, use with FWD, F.RUN as forward run and Rev, R.RUN as reverse run.

With the VT240S, the counterclockwise rotation (CCW) looking from the motor shaft is defined as forward run, and clockwise rotation (CW) is defined as reverse run.

Forward run (CW)

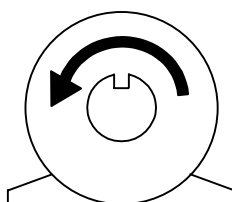

Reverse run (CW)

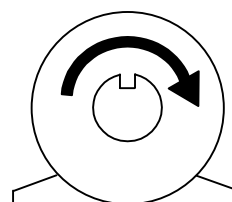

Definition of VT240S motor rotation direction

For PM motor with sensor control, the speed detection option is required in addition to the VT240S standard unit. Refer to Table 3-4-3-a, and confirm that the speed detection option compatible with the encoder in use has been prepared. Refer to Chapter 7 for details on the speed detection option.

Table 3-4-3-a

Encoder type	Speed detection option (Instruction Manual No.)
1) A, B, Z phase + U, V, W phase signals	V24-DN3 (ST-3482)
2) A, B, Z phase + serial absolute signals	V24-DN2 (ST-3481)
3) A, B, Z phase + U, V, W phase signals (reduced-wiring type)	V24-DN2 (ST-3481)
4) Sine wave signal	V24-DN4 (ST-3483)

- 1) A, B, Z phase + U, V, W phase signals
This incremental encoder outputs the A, B, Z phase and U, V, W phase pulse signals.
- 2) A, B, Z phase + serial absolute signals
This encoder outputs the A, B, Z phase pulse signals and serial absolute signal.
- 3) A, B, Z phase + U, V, W phase signals (reduced-wiring type)
With this encoder, the output signals are the same as the 1) type, but there are three output signal wires, and the A, B, Z phase and U, V, W phase output signals can be interchanged.
- 4) Sine wave signal
This encoder outputs a multi-cycle (i.e., 2048 cycle) 2-phase sine wave signals SIN, COS (equivalent to A, B phases) with one rotation, and outputs the Z-phase pulse and 1-cycle 2-phase sine wave signals SIN and COS with one rotation.

This automatic tuning must be carried out with the motor isolated from the load and machine. If mechanical brakes are applied on the motor, make sure that the brakes can be released during automatic tuning.

3. Test Operation and Adjustment

(2) Outline of automatic tuning in PM motor control mode

This automatic tuning is a function with automatically adjusts the phase angle (C51-4) of the encoder Z phase pulse and PM motor U phase coil. Automatic tuning in the PM motor control mode does not have the PM motor circuit constant measurement function. The number of encoder pulses and the encoder signal type selection must be set.

When C51-4 is automatically adjusted with this automatic tuning function, the phase does not need to be adjusted when installing this encoder onto the PM motor. Even if the adjustment has been completed, it should be readjusted to increase the adjustment accuracy.

B19-0=6: Mode 6: PM motor control encoder phase adjustment mode (Execution time: approx. 7 sec.)

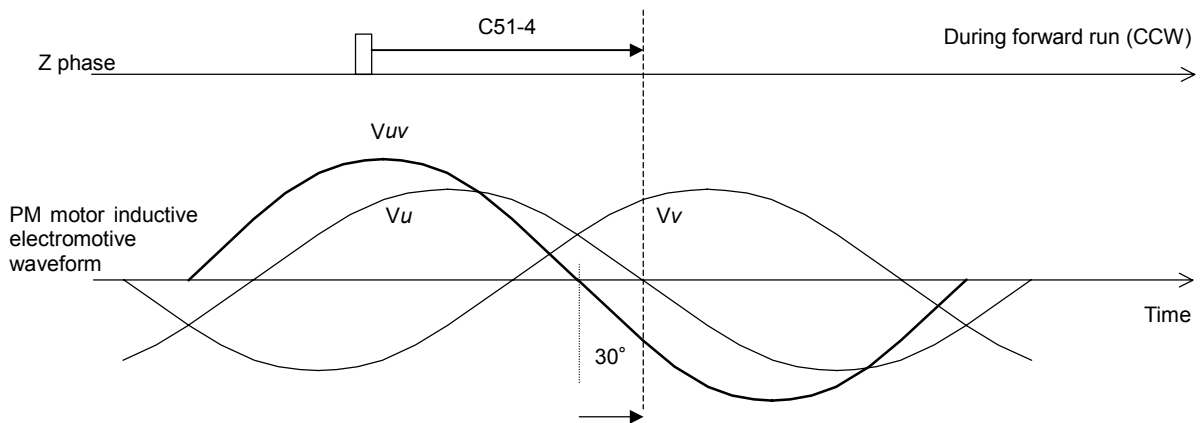

Relation of encoder Z phase pulse and PM motor inductive electromotive waveform phase

(Note) When using the PM motor with sensor control (C30-0 f_0 = 4), the automatic tuning function will not start even if B19-0 = 0 to 5 is selected.



CAUTION

Precautions for executing encoder phase adjustment mode (PM motor control)

- Do not carry out maintenance, such as wiring or mounting the option PCB while the PM motor is running. Even if the inverter power is not turned ON, the PM motor could rotate by the connected load or machine and cause a high voltage to be generated in the motor terminals. If the PM motor is connected to the inverter, the inverter could be powered when the PM motor rotates.
- Before mounting the PCB for the speed detection option onto the control PCB, always turn the inverter power OFF and wait at least 20 minutes. Confirm that all displays on the operation panel are OFF and that the "CHARGE" LED in the unit is OFF before starting the mounting work. Note that the main circuit terminals are charged to a high voltage.
- Always ground the motor and inverter.
- When executing automatic tuning, the motor must be isolated from the load and machine, etc. The motor will automatically rotate in the forward and reverse run directions during automatic tuning. Always check the safety around the motor before starting automatic tuning.
- If the load is less than 10% and the fluctuation does not occur, automatic tuning can be carried out with the load and machine connected. However, the performance may not be complete.
- Automatic tuning can be started only in the local operation mode. Confirm that the "LCL" LED is ON.
- The motor could vibrate and rotate during automatic tuning.
If the vibration is large, turn the  key immediately to stop operation.
- If the automatic tuning function does not end correctly, always turn the inverter power OFF before investigating or confirming the operation.
- The contact output FLT will function if the automatic tuning does not end correctly. In equipment that uses this contact, keep the operation of the related devices in mind.
- After setting the encoder parameters or after automatic tuning, do not move the position at which the encoder is fixed onto the motor, or interchange the motor's U, V, W phase wires.

3. Test Operation and Adjustment

(3) Automatic tuning operation procedures (PM motor control mode)

Adjust the magnetic pole position estimation function with the following procedure. Refer to Chapter 4 for details on using the operation panel.

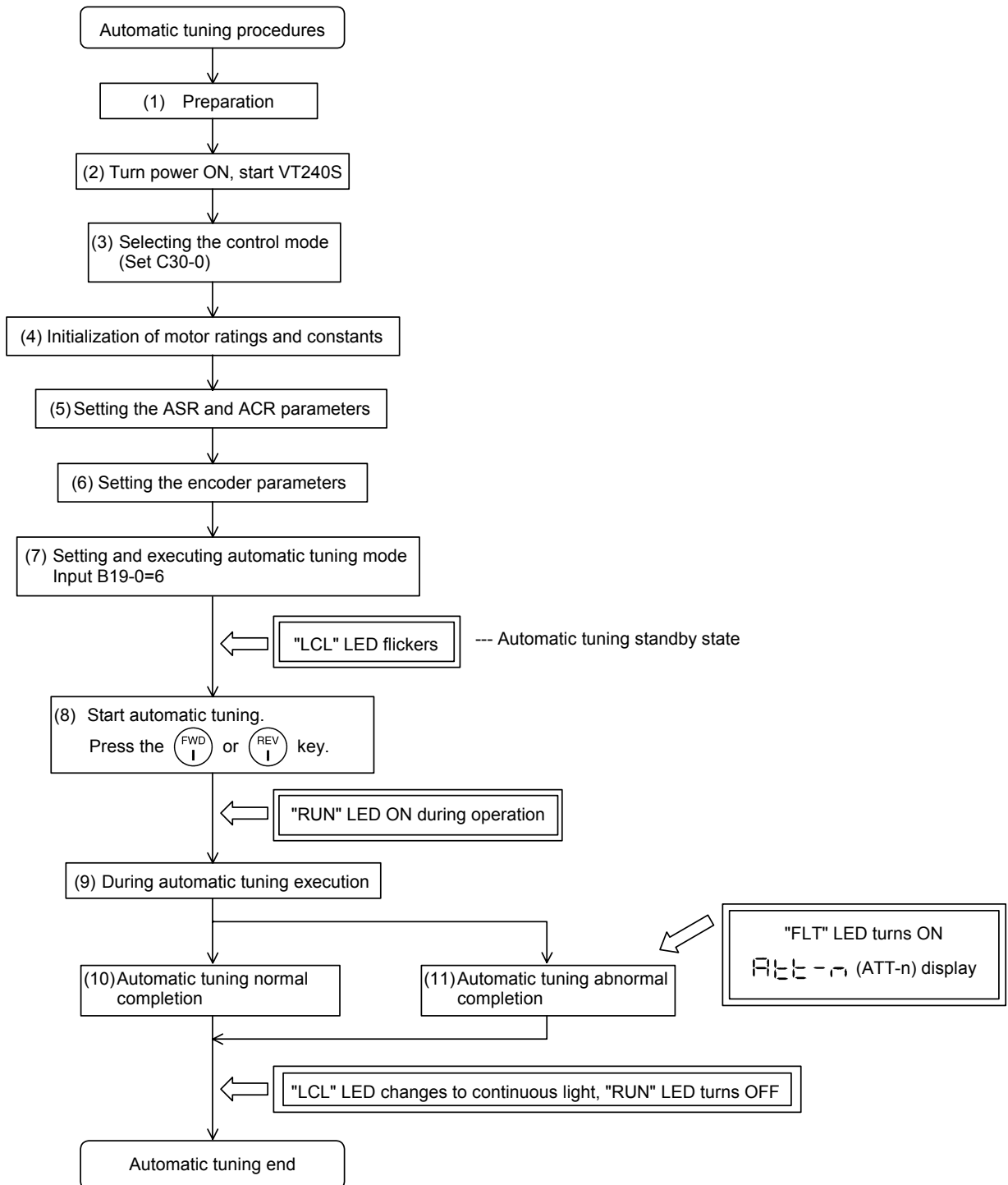

Fig. 3-4-3 Procedures for automatically tuning the encoder phase for PM motor control

3. Test Operation and Adjustment

1) Preparation (Before turning the power ON)

Confirm at the speed detection option PCB is correctly mounted on the control PCB, and that the encoder signal wire is correctly connected to the speed detection option. Refer to the instruction manual of the speed detection option being used for details on connecting the encoder signal wire.

Separate the motor and load, machine, etc., and confirm the safety on the load side.

2) Turning the power ON and starting VT240S (In the case of V24-OP2)

Turn the power ON.

All LEDs on the numeric display will turn ON

for a short time, and then "-----",

"800-0" and "OFF" will appear.

The "LCL" and "Hz" LEDs will also turn ON.



(Note) When the power is turned ON next (after setting C30-0 f0 =4), "800-2" will appear on the display, and the "Hz" LED will not light. This is because the mode is set to the PM motor vector control mode.

3) Selecting the control mode

- Set A05-2 to 1. (Set the hardware option function display ON.)

- Set the control mode selection: C30-0 f1 f0.

This parameter must be set first. **(Note 1)**

PM motor with sensor control mode is to be used, so set C30-0 f0 = 4.

Set c30-0 f1 f0 as shown below according to the load.

Normal overload setting : C30-0 f1 f0 = 1 4

Heavy overload setting : C30-0 f1 f0 = 2 4

(Note 1) The default value is set to V/f control and normal overload setting (C30-0=11), so always change C30-0.

There are some parameters which will change automatically when C30-0 is changed, so also set this first.

(Note 2) If the fault "SP-5" occurs when the C30-0 setting is changed, the following causes can be considered.

- The speed detection option is not mounted correctly.
- The encoder signal wire is not connected correctly, or is broken.

Turn the inverter power OFF and check the state.

4) Initialization of motor rating and motor constants

Input the parameters required for PM motor control. Set the parameters shown in Table 3-4-3-b.

Table 3-4-3-b

Parameter No.	Name	
B01-0	Rated input voltage setting	[No.]
B01-1	Motor rated output	[kW]
B01-2	No. of motor poles	[Pole]
B01-3	Rated output voltage	[V]
B01-4	Max. speed	[min ⁻¹]
B01-5	Base speed	[min ⁻¹]
B01-6	Motor rated current	[A]
B01-7	Carrier frequency	
B01-8	No. of encoder pulses	[P/R]
B03-0	R1: PM motor primary resistance (Mantissa section)	[mΩ]
B03-1	R1: PM motor primary resistance (Exponent section)	
B03-2	Ld: PM motor d axis inductance (Mantissa section)	[mH]
B03-3	Lq: PM motor q axis inductance (Mantissa section)	[mH]
B03-4	Ld, Lq: PM motor inductance (Exponent section)	

* The max. speed cannot be set below the base speed, and the base speed cannot be set above the max. speed.

3. Test Operation and Adjustment

5) Setting the ASR and ACR parameters

When performing automatic tuning, do not change the ASR (speed control) and ACR (current control) parameters shown in Table 3-4-3-c from the default values. Note that A10-1 must be set to the value obtained with the following expression.

Table 3-4-3-c

Parameter No.	Name	Standard value
A10-0	ASR response	10.0 [rad/s]
A10-1	Machine time constant	1000 [s]
A10-2	Integral time constant compensation coefficient	100 [%]
A10-3	ASR drive torque limiter	100 [%]
A10-4	ASR regenerative torque limiter	100 [%]
A20-0	ACR response	1500 [rad/s]
A20-1	ACR time constant	10.0 [ms]

Use the following expression and set A10-1: machine time constant according to the inertia of the isolated PM motor being used. The machine time constant (T_m) refers to the time required to accelerate to the base rotation speed from the zero speed at the rated torque.

$$T_m [\text{ms}] = 10.97 \times J [\text{kg}\cdot\text{m}^2] \times (\text{Nbase} [\text{min}^{-1}])^2 / \text{Power} [\text{W}]$$

J : Total inertia [$\text{kg}\cdot\text{m}^2$] (= $1/4 \times \text{GD}^2$ [$\text{kgf}\cdot\text{m}^2$])

Nbase : Base rotation speed [min^{-1}]

Power : Motor rated output [W]

The parameters shown in Table 3-4-3-d are used for automatic tuning. Set these parameters to the default values when executing automatic tuning.

Table 3-4-3-d

Parameter No.	Name	Standard value
A03-2	DC brake current	50 [%]

6) Setting the encoder parameters

Four types of encoders can be used with the VT240S PM motor with sensor control. The types and corresponding speed detection options are shown in Table 3-4-3-e.

Table 3-4-3-e

Encoder type	Speed detection option (Instruction Manual No.)
1) A, B, Z phase + U, V, W phase signals	V24-DN3
2) A, B, Z phase + serial absolute signals	V24-DN2
3) A, B, Z phase + U, V, W phase signals (reduced-wiring type)	V24-DN2
4) Sine wave signal	V24-DN4

The parameters must be set to match the encoder being used.

The parameters which must be set for each encoder are shown below.

3. Test Operation and Adjustment

1) A, B, Z phase + U, V, W phase signals

Parameter No.	Name
C50-2	Encoder AB advance direction selection
C50-3	Encoder ABZ pulse type selection
C51-0	Encoder selection
C51-1	AB phase-Z phase type selection
C51-2	Encoder Z signal reversal
C51-3	Encoder UVW advance direction selection
C51-4	Z-IN → U phase winding phase angle
C51-5	Z-IN → U phase angle
C51-6	Encoder UVW pulse type selection

2) A, B, Z phase + serial absolute signals

Parameter No.	Name
C50-2	Encoder AB advance direction selection
C50-3	Encoder ABZ pulse type selection
C51-0	Encoder selection
C51-1	AB phase-Z phase type selection
C51-2	Encoder Z signal reversal
C51-4	Z-IN → U phase winding phase angle
C51-5	Z-IN → U phase angle

3) A, B, Z phase + U, V, W phase signals (reduced-wiring type)

Parameter No.	Name
C50-2	Encoder AB advance direction selection
C50-3	Encoder ABZ pulse type selection
C51-0	Encoder selection
C51-1	AB phase-Z phase type selection
C51-2	Encoder Z signal reversal
C51-3	Encoder UVW advance direction selection
C51-4	Z-IN → U phase winding phase angle
C51-5	Z-IN → U phase angle
C51-6	Encoder UVW pulse type selection
C51-7	UVW measurement start wait time
C51-8	UVW measurement time
C51-9	ABZ measurement start wait time

4) Sine wave signal

Parameter No.	Name
C50-2	Encoder AB advance direction selection
C50-3	Encoder ABZ pulse type selection
C51-0	Encoder selection
C51-1	AB phase-Z phase type selection
C51-2	Encoder Z signal reversal
C51-4	Z-IN → U phase winding phase angle
C51-5	Z-IN → U phase angle

(Note) C51-4: Z-IN → U phase winding phase angle is automatically adjusted with automatic tuning. Refer to section 6-6 and set only when automatic tuning cannot be executed. The method for setting each parameter is shown below. Set these in order. When automatic tuning is executed, the parameters in Table 3-4-3-f are automatically changed, so the setting values should be noted down.

Table 3-4-3-f

Applicable mode	Parameter No.	Name
B19-0 = 6	C51-4	Z-IN → U phase winding phase angle

3. Test Operation and Adjustment

[1] C51-0: Encoder selection

Select the type of encoder signal to be used.

=1 : A, B, Z phase + U, V, W phase signals

=2 : A, B, Z phase + serial absolute signals

=3 : A, B, Z phase + U, V, W phase signals (reduced-wiring type)

=4 : Sine wave signal

[2] C50-2: Encoder AB advance direction selection

The motor's rotation direction is judged by the encoder A, B phase pulse phase advance and delay. Refer to the following figure and set this parameter according to the relation of the encoder AB phase signal phase relation during forward run (CCW rotation).

(Note) If C50-2 is set to 2, set C50-3 to 0.

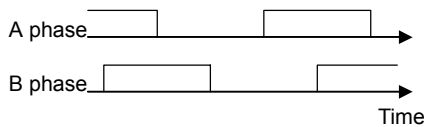

(a) When C50-2=1 (during CCW rotation)

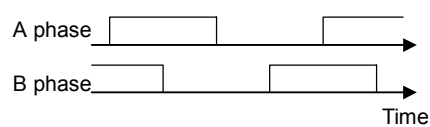

(b) When C50-2=2 (during CCW rotation)

[3] C51-1 : AB phase-Z phase type selection

[4] C51-2 : Encoder Z signal reversal

With the VT240S, the A, B, Z phase pulse encoder signals are defined as a waveform generated as shown below during forward run (CCW rotation).

C51-1 is set based on the phase relation of the A phase signal's rising edge and the Z phase signal. With this setting and at a time of reverse running, the A phase signal's down edge during the Z phase being high is the zero point.

To generate the A phase signal rising edge when the Z phase signal is High (Fig. (a)), set C51-1 to 0. In this case, the A phase signal rising edge will be the zero point (magnetic pole position). In all other cases, set C51-1 to 1. In this case, the Z phase signal's rising edge will be the zero point. (Fig. (b)). In this case, the Z phase rising edge is the zero point even at a time of the reverse running.

If the Z phase signal needs to be reversed to match the following signal definition, set C51-2 to 1.

(Note) If C51-2 is set to 1, set C50-3 to 0.

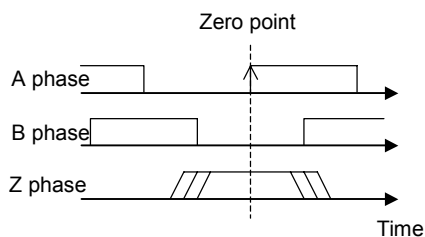

(a) When C51-1=0 (during CCW rotation)

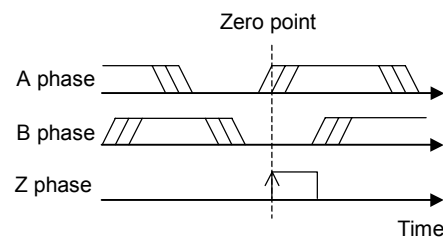

(b) When C51-1=1 (during CCW rotation)

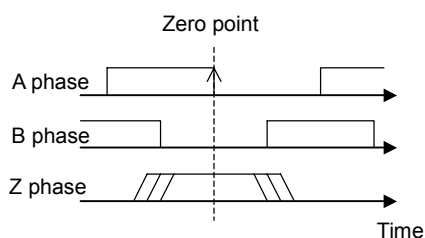

(c) When C51-1=0 (during CW rotation)

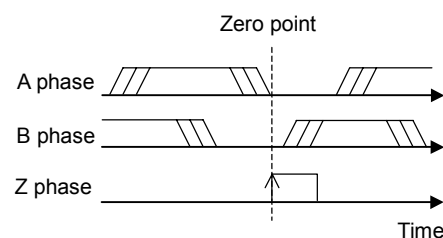

(d) When C51-1=1 (during CW rotation)

3. Test Operation and Adjustment

[5] C50-3 : Encoder ABZ pulse type selection

Only when using an encoder with signal specifications that cannot be handled with the C50-2 and C51-2 settings, set C50-3 to reverse or interchange the signals.

The signal conversion circuit will function with the combination shown in the table below according to the C50-3 setting value.

(Note) Set C50-3 to 0 (no signal reversal/interchange) when C50-2 and C51-2 have been set.

C50-3 setting value	A-IN forward/reverse run	B-IN forward/reverse run	Z-IN forward/reverse run	AB interchange
0	-	-	-	No interchange
1	Reverse	-	-	
2	-	Reverse	-	
3	Reverse	Reverse	-	
4	-	-	Reverse	
5	Reverse	-	Reverse	
6	-	Reverse	Reverse	
7	Reverse	Reverse	Reverse	
8	-	-	-	AB interchange
9	Reverse	-	-	
10	-	Reverse	-	
11	Reverse	Reverse	-	
12	-	-	Reverse	
13	Reverse	-	Reverse	
14	-	Reverse	Reverse	
15	Reverse	Reverse	Reverse	

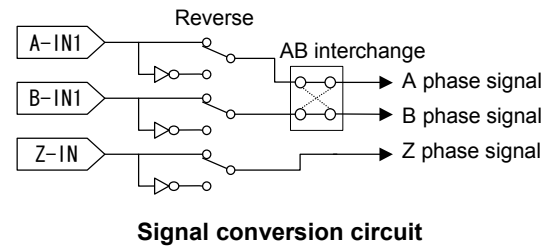

[6] C51-3 : Encoder UVW advance direction selection

[7] C51-6 : Encoder UVW pulse type selection

Set these parameters when using an A, B, Z phase + U, V, W phase signal or wire-reduced type A, B, Z phase + U, V, W phase signal encoder.

When using the wire-reduced type A, B, Z phase + U, V, W phase signal encoder, the VT240S defines the first signal input in the A, B, Z phase signal wire as the U, V, W phase signals respectively.

Refer to the following figure and set C51-3 according to the phase relation of the encoder's U, V, W phase signals during forward run (CCW rotation).

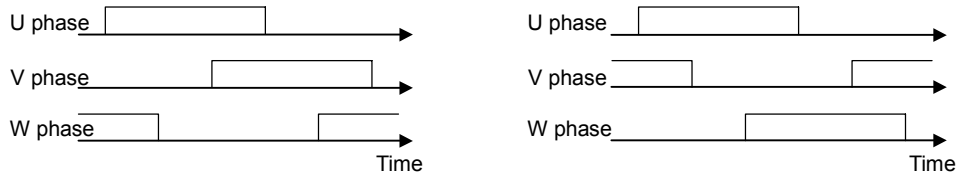

(a) When C51-3=1 (during CCW rotation)

(b) When C51-3=2 (during CCW rotation)

Only when using an encoder with signal specifications that cannot be handled with the C51-3 setting, refer to the following figure and table, and set C51-6 to reverse the signals.

Set C51-6 to 0 (no interchange) when C51-3 is set to 2.

3. Test Operation and Adjustment

C51-6 setting value	U-IN forward/reverse run	V-IN forward/reverse run	W-IN forward/reverse run
0	-	-	-
1	Reverse	-	-
2	-	Reverse	-
3	Reverse	Reverse	-
4	-	-	Reverse
5	Reverse	-	Reverse
6	-	Reverse	Reverse
7	Reverse	Reverse	Reverse

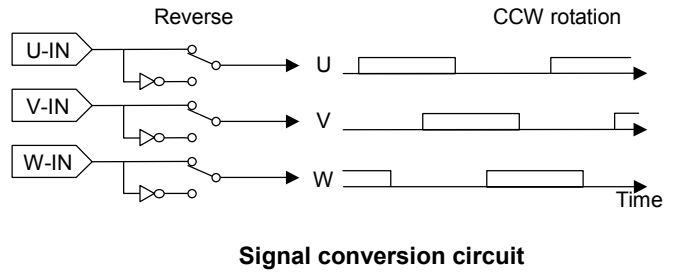

[8] C51-1 : Z-IN → U phase angle

- 1) For A, B, Z phase + U, V, W phase signal or wire-reduced type A, B, Z phase + U, V, W phase signal

If there is a phase difference between the Z phase pulse and U phase pulse of the encoder being used, set that phase difference in C51-5.

If there is no phase difference between the Z phase pulse and U phase pulse, set "0°".

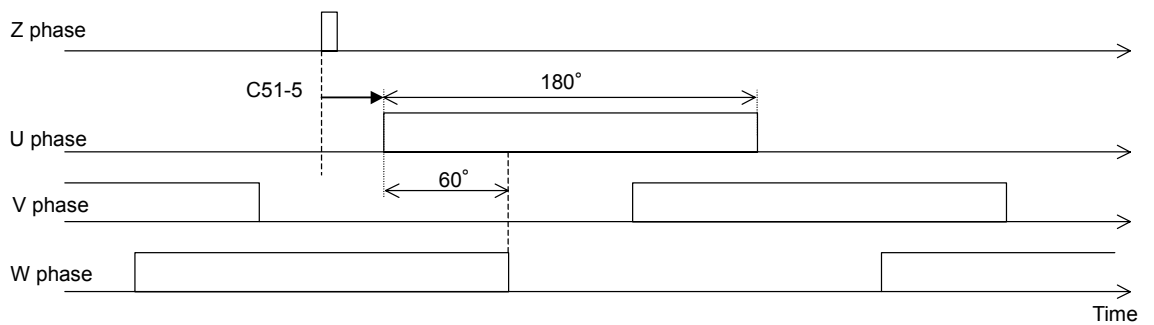

Encoder Z phase and U, V, W phase signals (during CCW rotation)

- 2) For A, B, Z phase + serial absolute

Only when there is a phase difference between the Z phase pulse and serial absolute signal zero point, set that phase difference with an angle unit.

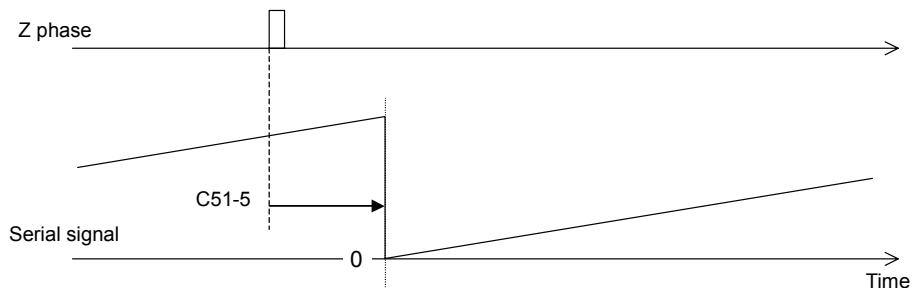

Encoder Z phase and serial absolute signal (during CCW rotation)

3. Test Operation and Adjustment

3) For sine wave signal

Set the phase of the sine wave signal generated by the Z phase pulse of the encoder in use in C51-5.

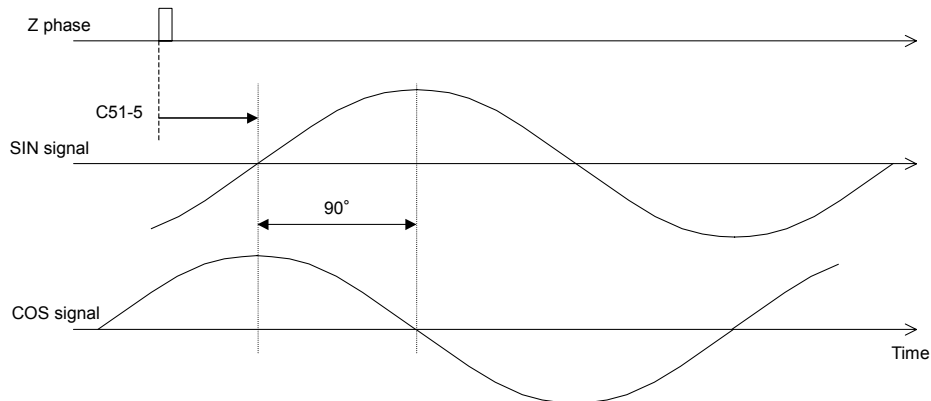

Encoder Z phase and sine wave signal (during CCW rotation)

- (9) Setting the parameters for the wire-reduced type A, B, Z phase + U, V, W phase signal encoder
 When using a wire-reduced type A, B, Z phase + U, V, W phase signal encoder, set the parameters shown below according to the specifications of the encoder in use.

Parameter No.	Name
C51-7	UVW measurement start wait time
C51-8	UVW measurement time
C51-9	ABZ measurement start wait time

The A, B, Z phase signal wires have a high impedance (hereafter, HI-Z) when the encoder power is turned ON. Set the UVW signal measurement start time in C51-7 based on the time that all three wires are released from the high impedance state.

Set the UVW signal measurement end time in C51-8 based on the UVW signal measurement start time (C51-7).

(If the UVW signal cannot be measured before this time elapses, the fault "SP-6" will be output.)

Set the time to wait before starting control with the ABZ signal in C51-9 based on the UVW signal measurement end time (C51-8).

(Note) The timer operates at a 2ms cycle, so set all of these times with an integer fold of 2.

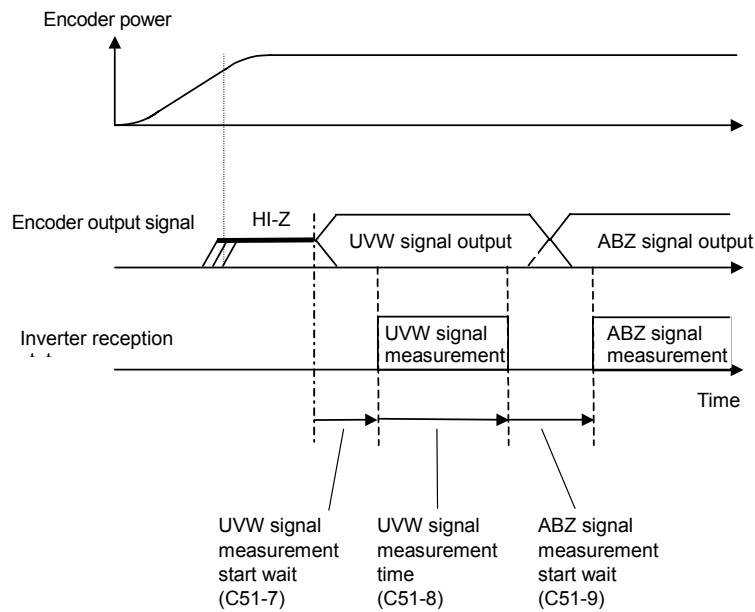

3. Test Operation and Adjustment





7) Selecting and executing the automatic tuning mode



Select the automatic tuning mode and execute automatic tuning.

- The operation panel's operation mode must be set to "Local" to execute automatic tuning.



Make sure that the "LCL" LED is ON. If not, press the  +  keys, and confirm that the "LCL" LED turns ON.

- Set A05-0 to 1. (Set the expanded setting display ON.)
- Set B19-0 (automatic tuning selection) to 6.
- The automatic tuning standby state will be entered when the  key is pressed.
- During the automatic tuning standby state and the automatic tuning execution state, the "LCL" LED will flicker.
- To exit the automatic tuning standby state, press the  key.

8) Starting automatic tuning

Automatic tuning will start when the  key or  key is pressed according to the required rotation direction.

To stop, press the  key or input the emergency stop signal (EMS) from the terminal block.

- * Once automatic tuning starts, all panel operations other than the ,  and  keys are disabled until the operation ends.

(Note) If mechanical brakes are applied on the motor, make sure that the brakes can be released during automatic tuning.

9) During automatic tuning execution

The progression state can be confirmed with D22-0.



Upper level: The steps required for tuning are indicated (lit).

Lower level: The finished steps are indicated (lit).
The step currently being executed is indicated with a flicker.

10) Normal completion of automatic tuning

When the automatic tuning ends normally, the "LCL" LED will change from a flicker to a stable light. The "RUN" LED will change from a flicker to a stable light.

11) Abnormal completion of automatic tuning

If automatic tuning ends abnormally, the "FLT" LED will turn ON and a message will appear. Investigate and check according to the error codes.

Refer to section 3-4-5 for details on the error codes.

(4) Test operation

Use the following procedures to test the operation with the operation panel.

Refer to Chapter 4 for details on using the operation panel.



CAUTION

To prevent incorrect operation during the test operation, make sure that signals are not input into the sequence input terminal.

- 1) To enable operation with the operation panel, confirm that the "LCL" LED is ON. If not, press the



+ keys, and confirm that the "LCL" LED turns ON.

- 2) Set speed setting input point selection: C02-0= 3 (panel fixed).



CAUTION

The motor will rotate with the next step.

Confirm the safety around the motor before starting the next step.

- 3) Press the  and display D00-2 on the monitor. Then press the  key. Operation will start.

The "FWD" lamp will turn ON, and the display will change from "OFF" to a value display. The value will gradually increase, and after several seconds, will change to "3000". This is because as the factory settings, the direct setting frequency (A00-2) is set to 300min⁻¹ and the acceleration ramp time 1 (A01-0) is set to 10sec.

3. Test Operation and Adjustment

CHECK

1. Did the motor run?
2. Is the run direction correct? Check the wiring and operation if abnormal.
3. Is the rotation smooth?

4) Press the  key and confirm that the motor runs in reverse.

(Note) Do not carry out this step if a load which cannot be run in reverse is connected.

5) Press the  key and stop the motor.



The operations for changing the speed during motor rotation are started next.



6) Press the  key. The motor will forward run at the output frequency 300min^{-1} .

7) Press the  key several times. The Display will alternate between "800.2" and "300.0".



8) Press the  key once.

The display will stop at "300.0", and the last digit will flicker.

This completes preparation for changing the motor speed. The digit to be changed can be moved with the  key. The speed can be increased or lowered with the   keys.

9) Move the digit with the  key, and using the  key, raise the frequency to " 600.0min^{-1} ".

Then, press the  key. The motor speed will increase to 600min^{-1} .



(Note) The operation panel motor speed change operation is set to be changed (C11-2=1) in real time at the factory shipment settings, and therefore the motor speed is changed in real time using the   keys, without having to press the  key.

When the  key is pressed, the current setting value will be saved.



CAUTION

A 10-second acceleration and 20-second deceleration ramp time are set as defaults. The motor will slowly increase its speed to the set value.

Carry out the setting operations (  key operation) at an approx. 100min^{-1} interval.

10) When the motor speed (D00-2 display) increases to 600min^{-1} , press the  key.

The D00-2 display will drop to "0.0" in several seconds. The "FWD" or "REV" LED will flicker for two seconds while the DC-brake is applied and the motor will stop.

This is because the default setting is A03-1=2.0 and A03-2=50 (DC brake setting).

3. Test Operation and Adjustment

11) Press the  key, and test the reverse run at the maximum speed.

(Note) Do not carry out this step if a load which cannot be run in reverse is connected.

This completes the test operation with the operation panel.

After this, refer to Chapter 4 and carry out the settings and adjust the load operation to match the user's application.

Refer to Section 6-9 for details on adjusting the PM motor vector control system parameters.

(Note) When the operation of the isolated motor ends, the parameter A10-1: machine time constant setting matches the motor unit's inertia. Refer to Section 6-8 and reset this parameter to match the inertia of the user's machine.

3-4-4 Magnetic pole position estimation function and test operation for PM motor with sensor control (C30-0 f0 = 4)

 **CAUTION**

This function can be used only with a system that drives a PM motor and which the motor is locked with mechanical brakes when stopped.
Refer to Section 3-4-3 for all other cases.

(1) Before adjusting magnetic pole position estimation function

When using the PM motor control mode, use with FWD, F.RUN as forward run and Rev, R.RUN as reverse run.

With the VT240S, the counterclockwise rotation (CCW) looking from the motor shaft is defined as forward run, and clockwise rotation (CW) is defined as reverse run.

Forward run (CW)

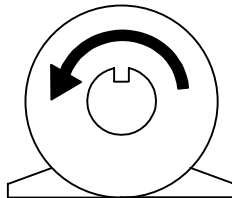

Reverse run (CW)

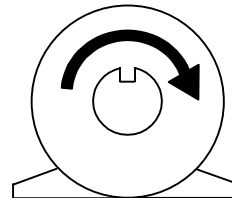

Definition of VT240S motor rotation direction

For PM motor with sensor control, the speed detection option is required in addition to the VT240S standard unit. Refer to Table 3-4-4-a, and confirm that the speed detection option compatible with the encoder in use has been prepared. Refer to Chapter 7 for details on the speed detection option.

Table 3-4-4-a



Encoder type	Speed detection option (Instruction Manual No.)
A, B, Z phase signals	V24-DN1 (ST-3480)
	V24-DN2 (ST-3481)
	V24-DN3 (ST-3482)
	V24-DN4 (ST-3483)

(2) Outline of magnetic pole position estimation function

The magnetic pole position estimation function is a special function for driving the PM motor with an incremental encoder has only the A, B, Z phase signals instead of the U, V, W signals or absolute value signals. This function estimates the motor's magnetic pole position in approx. two seconds when starting operation for the first item after turning the power ON. This uses the PM motor's magnetic saturation characteristics of inductance characteristics to search for the magnetic pole position when the motor stops.

After the motor starts running, the estimated magnetic pole position information is used for several rotations until the encoder's correct Z phase signal is detected. Once the Z phase signal is detected, the motor runs using that Z phase signal as a reference. If a fault occurs, the magnetic pole position is estimated again when operation starts again.

The magnetic saturation characteristics and inductance characteristics differ according to the PM motor being used, so the magnetic pole position estimation function must be adjusted to the motor being used. When B19-0 is set to 7, the magnetic pole position estimation adjustment mode which executes the magnetic pole position estimation operation only once is enabled. Adjust the magnetic pole position estimation with this mode before starting the motor operation.

(Note) The parameters are not automatically adjusted just by setting B19-0 to 7 and pressing the  and  keys. This mode executes magnetic pole position estimation operation just once for adjustment purposes.



CAUTION

Precautions for executing magnetic pole position estimation adjustment mode (PM motor control)

- Do not carry out maintenance, such as wiring or mounting the option PCB while the PM motor is running. Even if the inverter power is not turned ON, the PM motor could rotate by the connected load or machine and cause a high voltage to be generated in the motor terminals. If the PM motor is connected to the inverter, the inverter could be powered when the PM motor rotates. Confirm that the PM motor is fixed with brakes before starting wiring work, etc.
- Before mounting the PCB for the speed detection option onto the control PCB, always turn the inverter power OFF and wait at least 20 minutes. Confirm that all displays on the operation panel are OFF and that the "CHARGE" LED in the unit is OFF before starting the mounting work. Note that the main circuit terminals are charged to a high voltage.
- Always ground the motor and inverter.
- Always confirm the safety around the motor before starting the magnetic pole position estimation adjustment.
- The magnetic pole position estimation adjustment mode can be executed only in the local operation mode. Confirm that the "LCL" LED on the operation panel is ON.
- If magnetic pole position estimation operation does not end properly, always turn the inverter power OFF before investigating and confirming the state.
- The contact output FLT will activate if magnetic pole position estimation ends abnormally. In equipment that uses this contact, keep the operation of the related devices in mind.
- After setting the parameters or after adjusting the magnetic pole position estimation, do not move the position at which the encoder is fixed onto the motor, or interchange the motor's U, V, W phase wires.

(3) Adjusting magnetic pole position estimation function

Carry out automatic tuning with the following procedures.
Refer to Chapter 4 for details on using the operation panel.

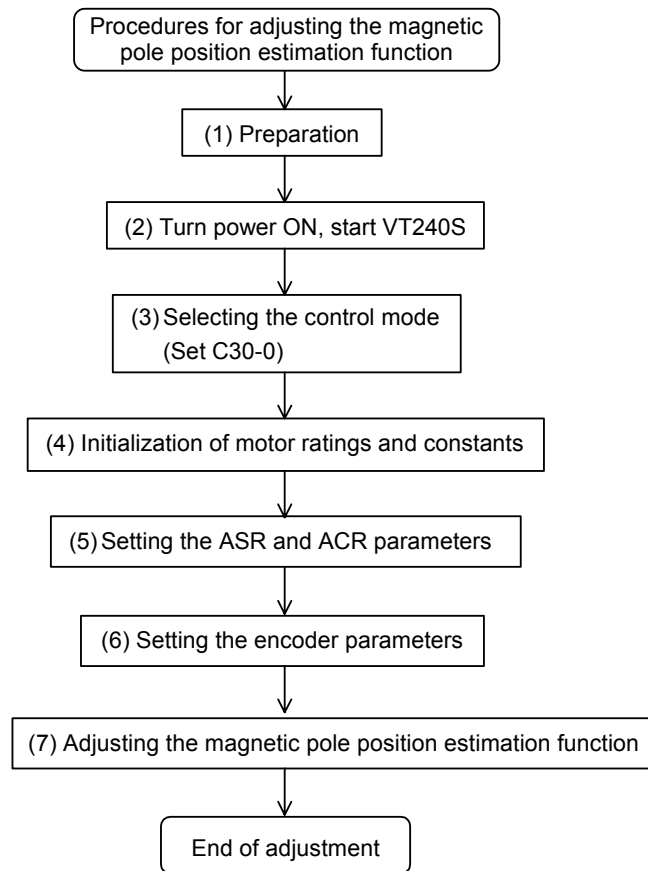

Fig. 3-4-4 Procedures for adjusting magnetic pole position estimation function for PM motor control

1) Preparation (Before turning the power ON)

Confirm at the speed detection option PCB is correctly mounted on the control PCB, and that the encoder signal wire is correctly connected to the speed detection option. Refer to the instruction manual of the speed detection option being used for details on connecting the encoder signal wire.

Confirm that the motor is locked with mechanical brakes.

2) Turning the power ON and starting VT240S (In the case of V24-OP2)

Turn the power ON.

All LEDs on the numeric display will turn ON for a short time, and then "-----",

"800-0" and "off" will appear.

The "LCL" and "Hz" LEDs will also turn ON.



(Note) When the power is turned ON next (after setting C30-0 $f_0 = 4$), "800-2" will appear on the display, and the "Hz" LED will not light. This is because the mode is set to the PM motor vector control mode.

3. Test Operation and Adjustment

3) Selecting the control mode

- Set A05-2 to 1. (Set the hardware option function display ON.)
- Set the control mode selection: C30-0 $\overline{f1}$ $\overline{f0}$.
This parameter must be set first.
PM motor with sensor control mode is to be used, so set C30-0 $\overline{f0}$ = 4.
Set c30-0 $\overline{f1}$ $\overline{f0}$ as shown below according to the load.

Normal overload setting : C30-0 $\overline{f1}$ $\overline{f0}$ = 1 4

Heavy overload setting : C30-0 $\overline{f1}$ $\overline{f0}$ = 2 4

(Note 1) The default value is set to V/f control and normal overload setting (C30-0=11), so always change C30-0.

(Note 2) If the fault "SP-5" occurs when the C30-0 setting is changed, the following causes can be considered.

- The speed detection option is not mounted correctly.
 - The encoder signal wire is not connected correctly, or is broken
- Turn the inverter power OFF and check the state.

4) Initialization of motor rating and motor constants

Input the parameters required for PM motor control. Set the parameters shown in Table 3-4-4-b.

Table 3-4-4-b

Parameter No.	Name	
B01-0	Rated input voltage setting	[No.]
B01-1	Motor rated output	[kW]
B01-2	No. of motor poles	[Pole]
B01-3	Rated output voltage	[V]
B01-4	Max. speed	[min ⁻¹]
B01-5	Base speed	[min ⁻¹]
B01-6	Motor rated current	[A]
B01-7	Carrier frequency	
B01-8	No. of encoder pulses	[P/R]
B03-0	R1: PM motor primary resistance (Mantissa section)	[mΩ]
B03-1	R1: PM motor primary resistance (Exponent section)	
B03-2	Ld: PM motor d axis inductance (Mantissa section)	[mH]
B03-3	Lq: PM motor q axis inductance (Mantissa section)	[mH]
B03-4	Ld, Lq: PM motor inductance (Exponent section)	

* The max. speed cannot be set below the base speed, and the base speed cannot be set above the max. speed.

5) Setting the ASR and ACR parameters

Do not change the ASR (speed control) and ACR (current control) parameters shown in Table 3-4-4-c from the default values before adjusting the magnetic pole position.

Note that A10-1 must be set to the value obtained with the following expression.

Table 3-4-4-c

Parameter No.	Name	Standard value
A10-0	ASR response	10.0 [rad/s]
A10-1	Machine time constant	1000 [s]
A10-2	Integral time constant compensation coefficient	100 [%]
A10-3	ASR drive torque limiter	100 [%]
A10-4	ASR regenerative torque limiter	100 [%]
A20-0	ACR response	1500 [rad/s]
A20-1	ACR time constant	10.0 [ms]

3. Test Operation and Adjustment

Refer to the following expression, and set the A10-1: machine time constant setting to match the inertia of the entire load connected with the PM motor. The machine time constant (T_m) refers to the time required to accelerate to the base rotation speed from the zero speed at the rated torque.

$$T_m [\text{ms}] = 10.97 \times J [\text{kg}\cdot\text{m}^2] \times (\text{Nbase} [\text{min}^{-1}])^2 / \text{Power} [\text{W}]$$

J : Total inertia [$\text{kg}\cdot\text{m}^2$] (= $1/4 \times \text{GD}^2 [\text{kgf}\cdot\text{m}^2]$)

Nbase : Base rotation speed [min^{-1}]

Power : Motor rated output [W]

6) Setting the encoder parameters

The encoder parameters shown in Table 3-4-4-d must be set.

Table 3-4-4-d

Parameter No.	Name
C50-2	Encoder AB advance direction selection
C50-3	Encoder ABZ pulse type selection
C51-0	Encoder selection
C51-1	AB phase-Z phase type selection
C51-2	Encoder Z signal reversal
C51-4	Z-IN → U phase winding phase angle

The method for setting each parameter is shown below. Set these in order.

[1] C51-0: Encoder selection

Use the default value when using the magnetic pole position estimation function.

[2] C50-2: Encoder AB advance direction selection

The motor's rotation direction is judged by the encoder A, B phase pulse phase advance and delay. Refer to the following figure and set this parameter according to the relation of the encoder AB phase signal phase relation during forward run (CCW rotation).

(Note) If C50-2 is set to 2, set C50-3 to 0.

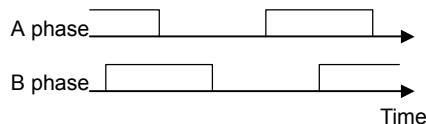

(a) When C50-2=1 (during CCW rotation)

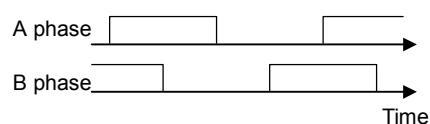

(b) When C50-2=2 (during CCW rotation)

[3] C51-1 : AB phase-Z phase type selection

[4] C51-2 : Encoder Z signal reversal

With the VT240S, the A, B, Z phase pulse encoder signals are defined as a waveform generated as shown below during forward run (CCW rotation).

C51-1 is set based on the phase relation of the A phase signal's rising edge and the Z phase signal. With this setting and at a time of reverse running, the A phase signal's down edge during the Z phase being high is the zero point.

To generate the A phase signal rising edge when the Z phase signal is High (Fig. (a)), set C51-1 to 0. In this case, the A phase signal rising edge will be the zero point (magnetic pole position). In all other cases, set C51-1 to 1. In this case, the Z phase signal's rising edge will be the zero point. (Fig. (b)). In this case, the Z phase rising edge is the zero point even at a time of the reverse running.

If the Z phase signal needs to be reversed to match the following signal definition, set C51-2 to 1.

(Note) If C51-2 is set to 1, set C50-3 to 0.

3. Test Operation and Adjustment

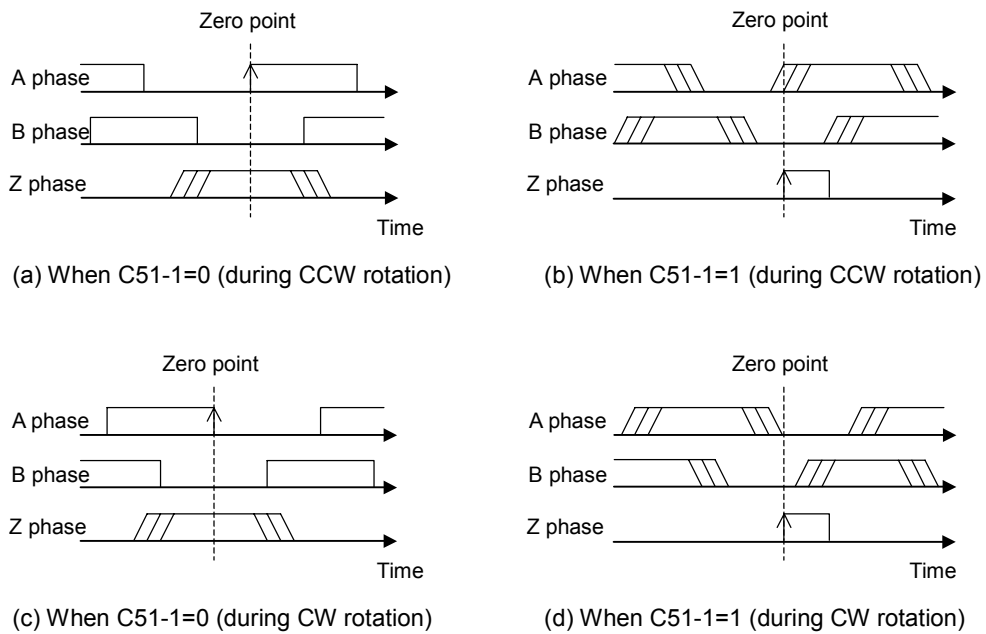

[5] C50-3 : Encoder ABZ pulse type selection

Only when using an encoder with signal specifications that cannot be handled with the C50-2 and C51-2 settings, set C50-3 to reverse or interchange the signals.

The signal conversion circuit will function with the combination shown in the table below according to the C50-3 setting value.

(Note) Set C50-3 to 0 (no signal reversal/interchange) when C5-2 and C51-2 have been set.

C50-3 setting value	A-IN forward/reverse run	B-IN forward/reverse run	Z-IN forward/reverse run	AB inter-change
0	-	-	-	No inter-change
1	Reverse	-	-	
2	-	Reverse	-	
3	Reverse	Reverse	-	
4	-	-	Reverse	
5	Reverse	-	Reverse	
6	-	Reverse	Reverse	
7	Reverse	Reverse	Reverse	
8	-	-	-	AB inter-change
9	Reverse	-	-	
10	-	Reverse	-	
11	Reverse	Reverse	-	
12	-	-	Reverse	
13	Reverse	-	Reverse	
14	-	Reverse	Reverse	
15	Reverse	Reverse	Reverse	

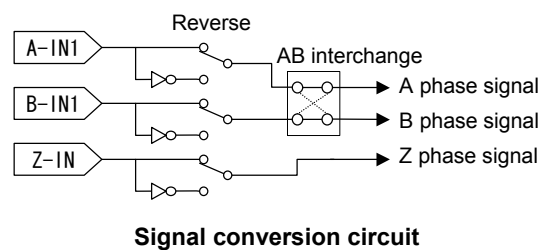

[6] C51-4: Z-IN → U phase winding phase angle

This can be automatically adjusted with automatic tuning when the motor can be run in an isolated state without a load connection. Release the external brakes, and refer to Section 3-5-3 and carry out step 7 and following of the Fig. 3-4-3 flow chart.

In other cases, this parameter is adjusted after the magnetic pole position estimation function has been adjusted. Proceed to adjustment of the magnetic pole position estimation.

3. Test Operation and Adjustment

7) Adjusting the magnetic pole position estimation function The magnetic pole position estimation function is adjusted.

- [1] Select the magnetic pole position estimation mode with the magnetic pole position estimation selection (B39-0 $\overline{f0}$).
- When the magnetic pole position estimation function is used, normally $\overline{f0} = 2$ should be selected. If the motor has a reverse inductance ($L_d < L_q$), select $\overline{f0} = 3$.
(Refer to Section 6-9 for an explanation on the PM motor circuit constant.)
Select $\overline{f0} = 3$, when not using a magnetic pole position estimation function, or when you stop use.
- [2] When B19-0 is set to 7 and the $\left(\frac{Lq}{SET}\right)$ key is pressed, the magnetic pole position estimation mode which executes the magnetic pole position estimation operation once will start. To carry out the same operation again, repeat the above step.
When the magnetic pole position estimation function starts normally, the operation will end in approx. two seconds.

(Note) The parameters are not automatically adjusted just by setting B19-0 to 7 and pressing the $\left(\frac{FWD}{I}\right)$ and $\left(\frac{REV}{I}\right)$ keys. This mode executes magnetic pole position estimation operation just once for adjustment purposes.

3. Test Operation and Adjustment

- [3] Adjust the magnetic pole position estimation function
 The parameters required for adjusting the magnetic pole position estimation function are shown in Table 3-4-4-e. The parameters which indicate the magnetic pole position estimation results are shown in Table 3-4-4-f.

Table 3-4-4-e

Parameter No.	Name
B39-1	Magnetic pole position estimation voltage
B39-2	Magnetic pole position estimation time
B39-3	Voltage error correction current
A20-0	ACR response (PM motor control)
A20-1	ACR time constant (PM motor control)

Table 3-4-4-f

Parameter No.	Name	Adjustment reference
D16-0	Characteristic amount during magnetic pole position estimation 1	Adjust to 120% or more.
D16-1	Characteristic amount during magnetic pole position estimation 2	Adjust to 120% or more.
D16-2	Magnetic pole position estimation current	Make sure the current does not exceed 120%. If too high, the inverter could stop with an overcurrent (OCT) fault.
D16-3	Magnetic pole position estimation error	Adjust to within 10°.

If B39-1, 2 (magnetic pole position estimation voltage) is increased, D16-0, 1 will increase. Adjust to match the adjustment reference conditions given in Table 3-4-4-f.

When D16-0, 1 is at the adjustment reference value, normally, the D16-3 value will be within the adjustment reference range.

If B39-1, 2 is too large, the noise during estimation will increase. If the generated noise is too large, decrease D39-1, 2 within the range that the adjustment reference given in Table 3-4-4-f is satisfied.

To decrease B39-1, 2, first decrease B39-1. If the noise is still large even after B39-1 is decreased by 20%, then decrease B39-2.

If D16-0 to 3 do not stabilize even after carrying out the magnetic pole position estimation operation repeatedly, it might stabilize by increasing B39-3 by approx. 20%. However, normally B39-3 can be set to the default value without problem.

If the magnetic pole position estimation function operation takes more than two seconds, ACR must be adjusted. Increase A20-0 (ACR response) or decrease A20-1 (ACR time constant) so that the magnetic pole position estimation operation ends in approx. two seconds.

If the magnetic pole position estimation results are not stable for any reason, the magnetic pole position estimation function cannot be used. Use an encoder with a magnetic pole position detection signal, such as a UVW signal or serial absolute signal. Refer to Section 3-5-3, set the encoder, and carry out test operation.

- [4] When finished adjusting the magnetic pole position estimation function, return the setting to B19-0=0.

(Note 1) When the magnetic pole position estimation adjustment mode is carried out with B19-0 set to 7, the SFP (magnetic pole position established) flag is set so the magnetic pole position will not be estimated the next item operation is set. B19-0 must be returned to 0.

(Note 2) After setting these parameters, do not move the encoder fixed onto the motor, or interchange the motor's U, V, W phase wires.

(4) Setting the parameters for the external brake function, etc.

1) Setting the external brake control function

The external brakes can be turned ON and OFF following the inverter's internal sequence. The external brake function has various wait time settings and interlock functions. This function is set. The parameters which need to be set are shown in Table 3-4-4-g.

Table 3-4-4-g

Parameter No.	Name
B46-0	External brake selection
B46-1	Brake open wait time (LB)
B46-2	Acceleration start wait time (BL)
B46-3	Brake close wait time (DB)
B46-4	RUN error judgment time at brake closed
B46-5	Brake answer error judgment time

- [1] B46-0: External brake selection
 Set B46-0 **f0** to 2 to use the external brake control function.
 When B46-0 **f1** is set to 2, the interlock function using IDET is enabled. If IDET does not turn ON when the brakes are released (immediately after LB), the motor will stop with a fault "IO-C".
 Set the control mode for the acceleration wait time (LB, BL) with B46-0 **f2**.
 When **f2** is set to 1, the normal operation mode is enabled.
 When **f2** is set to 2, the DC brake mode is enabled.

- [2] B46-1: Brake open wait time (LB)
 Set the time to wait (LB) from RUN to brake open.

- [3] B46-2: Acceleration start wait time (BL)
 Set the wait time (LB) from brake open to start of acceleration.
 If brake answer is enabled (B46-5≠0.0sec) set the time after brake answer. If brake answer is disabled (B46-5=0), set the time from the brake open command.
 When using normal operation mode setting, the program settings will not be changed during BL, and instead the settings prior to BL will be held.

- [4] B46-3: Brake close wait time (DB)
 Set the wait time (DB) from time from ZSP (zero speed) ON to brake close.

- [5] B46-4: RUN error judgment time at brake closed
 If RUN does not turn OFF at the time set in D46-4 after the brakes are closed, the host controller will judge that there is an error, and will stop the motor with the external brake RUN error (IO-D) fault. RUN error judgment can be turned OFF by setting 0.0sec.

- [6] B46-5: Brake answer error judgment time
 If brake command (MBRK) and brake answer (MBRK_ans) do not match for longer than the time set in B46-5, it will be judged as an external brake fault, and the motor will stop with the external brake answer error (IO-E) fault. Brake answer error judgment can be turned OFF by setting 0.0sec.

3. Test Operation and Adjustment

An example of the external brake sequence is shown below.

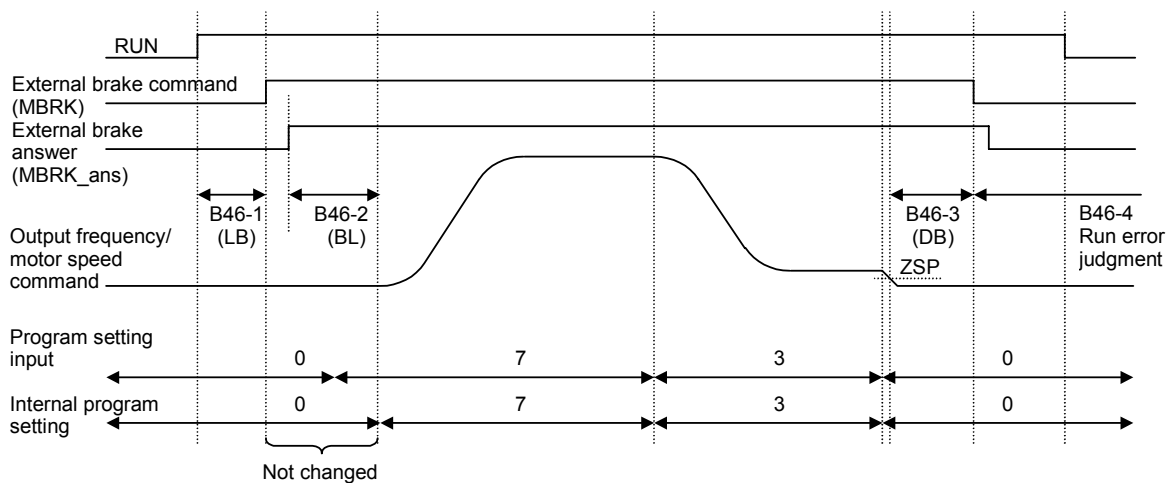

Example of external brake sequence when using program settings (B46-0 f2=1) and with brake answer (B46-5≠0.0)

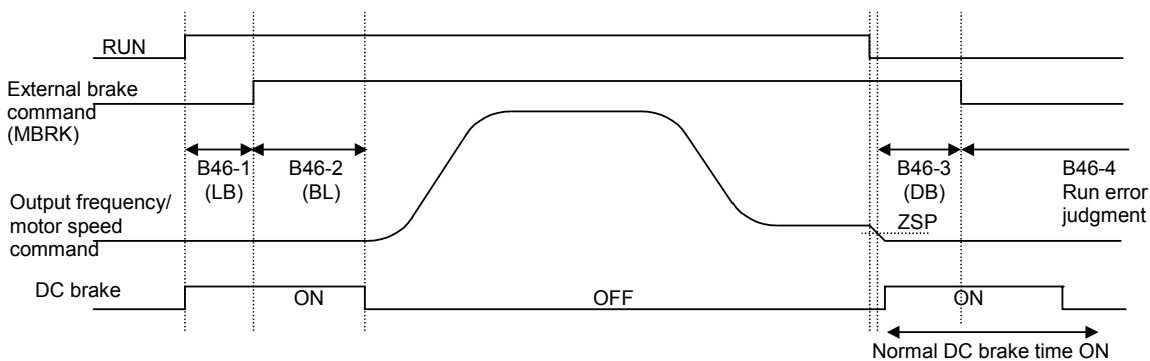

Example of external brake sequence when using DC brake (B46-0 f2=2) and no brake answer (B46-5=0.0.)

External brake control (B46) is sequenced with magnetic pole position estimation function. The external brake control starts after the magnetic pole position estimation is completed. Thus, the magnetic pole position estimation time does not need to be considered for the external brake function.

2) Setting the external brake control sequence

- [1] The J1 setting must be turned ON to use external brake control or the other sequence functions. Set C00-5 to 2.
- [2] Set the external brake signal (MBRK) sequence output function. Refer to the following table, and set "27" for the parameter corresponding to the output terminal being used. Set "-27" to reverse the signal.

Control PCB output terminal	Corresponding parameter
RC-RA	C13-2
PS01	C13-3
PS02	C13-4
PS03	C13-5
FA-FC	C13-6

3. Test Operation and Adjustment

- [3] Set the external rake answer signal (MBRK_ans) sequence input function. Refer to the following table and set the value corresponding to the input terminal (control PCB PSI1 to 11) in C04-E. Set a negative value to reverse the signal.

Control PCB input terminal	C04-E setting value (Note 2)
PSI1	1
PSI2	2
PSI3	3
PSI4	4
PSI5	5
PSI6	6
PSI7	7
PSI8 (Note 1)	8
PSI9 (Note 1)	9
PSI10 (Note 1)	10
PSI11 (Note 1)	11

(Note 1) PSI8 to 11 are the relay option PCB's sequence input terminals. Prepare the relay option to use these.

(Note 2) Do not set C04-E to "0" or "16". The MBRK_ans signal input will be fixed to OFF or fixed to ON.

3) Setting the ACR reverse run prevention function

If the motor must not rotate in the reverse direction of the run command, set the reverse run detection error level in C24-7. If the motor rotates in the reverse direction, it will stop with a fault. Set this parameter as a percentage of the error detection level speed using the base speed as 100%. This function is invalid when "0" is set.

(5) Setting the C51-4: Z-IN → U phase winding phase angle parameter

In the PM motor control mode, the C51-4: Encoder Z-IN → U phase winding phase angle parameter must be set. Set this parameter.

If the settings up to this point have not been completed, refer to the previous section and complete the settings.

(Note) This can be automatically adjusted with automatic tuning when the motor can be run in an isolated state. Release the external brakes, and refer to Section 3-4-3 and carry out step 7 and following of the Fig. 3-4-3 flow chart. This step can be skipped if the parameter is set with automatic tuning.

This parameter must be set only once at the very start of operation.

After setting this parameter, do not move the encoder fixed onto the motor, or interchange the motor's U, V, W phase wires.

- 1) The motor must be rotated to set this parameter.

First, set the speed and ramp time parameters required for rotating the motor. Refer to Table 3-4-4-h and set each parameter.

Table 3-4-4-h







Parameter No.	Name	Setting method
A00-2	Direct setting speed	Set the motor speed with a $[\text{min}^{-1}]$ unit.
A01-0	Acceleration ramp time	Set the acceleration time from stop to maximum speed, and the deceleration time from maximum speed to stop.
A01-1	Deceleration ramp time	

3. Test Operation and Adjustment



CAUTION

The motor will rotate with the next step.
Confirm the safety around the motor before starting the next step.



- 2) When issuing the run/stop commands from the operation panel (local operation mode), confirm that "LCL" is ON. When using sequence input (remote operation mode), confirm that "LCL" on the operation panel is OFF. Press the  +  keys to change the operation mode.
- 3) Set B39-0  to 2. With this setting, the encoder's Z phase is not used, and the motor is run with the estimated magnetic pole phase. Start and stop in this mode.
- 4) Set the speed with the operation panel.
Set the speed setting input point selection C02-0 to 3 (panel fixed).
Set the motor speed in A00-2.
- 5) Open the external brakes to rotate the motor.
- 6) Input the forward run command.
To issue the command from the operation panel, press the  key.
- 7) Input the stop command, and stop the motor.
To issue the command from the operation panel, press the  key.
- 8) After stopping, set the value displayed at D26-0 in C51-4.
- 9) Set B39-0  to 1. The mode will return to the normal operation mode.

(6) Test operation

When finished with automatic tuning, test run the isolated motor, and make sure that there are no errors.

Use the following procedures to test the operation with the operation panel.

Refer to Chapter 4 for details on using the operation panel.



When issuing the run/stop commands from the operation panel (local operation mode), confirm that "LCL" is ON. When using sequence input (remote operation mode), confirm that "LCL" on the operation panel is OFF. Press the  +  keys to change the operation mode.

- 1) Set the speed from the operation panel.
Set speed setting input point selection: C02-0= 3 (panel fixed).
Set the motor speed in A00-2.



CAUTION

The motor will run. Confirm the safety around the motor before starting the next step.

- 2) Open the external brakes to rotate the motor.
- 3) Press the  key to display the D00-2 on the monitor, and then input the forward run command
To issue the command from the operation panel, press the  key.
The "FWD" lamp will turn ON, and the display will start increasing from "  ".
Confirm the speed with D00-2, and make sure that it is equal to the A00-2 setting value.

3. Test Operation and Adjustment

CHECK

1. Did the motor run?
2. Is the run direction correct? Check the wiring and operation if abnormal.
3. Is the rotation smooth?

4) Input a reverse run command and confirm that the motor runs in reverse.

To issue the command from the operation panel, press the  key.

5) Input the stop command, and stop the motor.

To issue the command from the operation panel, press the  key.

The operations for changing the speed during motor rotation are started next.



6) Input the forward run command.

To issue the command from the operation panel, press the  key.



7) Press the  key several times. Set so that "A00-2" and the current speed setting value appear alternately on the display.

8) Press the  key once.

The display will stop at the current setting value, and the first decimal digit will flicker.

This completes preparation for changing the motor speed. The digit to be changed can be moved with the  key. The speed can be increased or lowered with the   keys.



9) Change the A00-2 setting value and press the  key. Display D00-2 and confirm that the motor speed has changed to the set value.

(Note) The operation panel frequency change operation is set to be changed (C11-2=1) in real time at the factory shipment settings, and therefore the output frequency is changed in real time using the   keys, without having to press the  key.

When the  key is pressed, the current setting value will be saved.

CAUTION

A 10-second acceleration and 20-second deceleration ramp time are set as defaults. The motor will slowly increase its speed to the set value. (When the set value is not changed)

Change the A00-2 setting value with an interval of 100min⁻¹ or less. (Use the   keys.)

10) Confirm that the motor speed (D00-2 display) is the same as the setting value, and then input the stop command. Press the  key when using the operation panel.

The display will decrease to "0.0" in several seconds. The "FWD" or "REV" LED will flicker for two seconds while the DC-brake is applied and the motor will stop.

This completes the test operation.

(Note) When the test operation ends, the parameter A10-1: machine time constant setting matches the motor unit's inertia. Refer to Section 6-8 and reset this parameter to match the inertia of the user's machine.

(7) Other functions of magnetic pole position estimation

1) Magnetic pole position estimation retry function

If the characteristics amount measured during magnetic pole position estimation do not reach the reference value, the magnetic pole position estimation will be retried. The retry conditions are shown in Table 3-4-4-i.

The estimation is retried up to three times. If the reference is not reached after three retries, the operation will stop with a fault (ATT-9).

If this fault occurs, adjust the magnetic pole position estimation function again.

Table 3-4-4-i

Parameter No.	Name	Adjustment reference
D16-0	Characteristic amount during magnetic pole position estimation 1	110% or less
D16-1	Characteristic amount during magnetic pole position estimation 2	110% or less
D16-3	Magnetic pole position estimation error	20° or more

2) Sequence output

The magnetic pole position setting flag can be sequence output. If C13-2 to 6 is set to 40 (FPOS), when the magnetic pole position is set the output will turn ON from the control PCB terminal corresponding to each parameter. If C13-2 to 6 is set to -40, a signal with the sequence logic reversed will be output.

The sequence output RUN signal is not output during the magnetic pole position estimation operation.

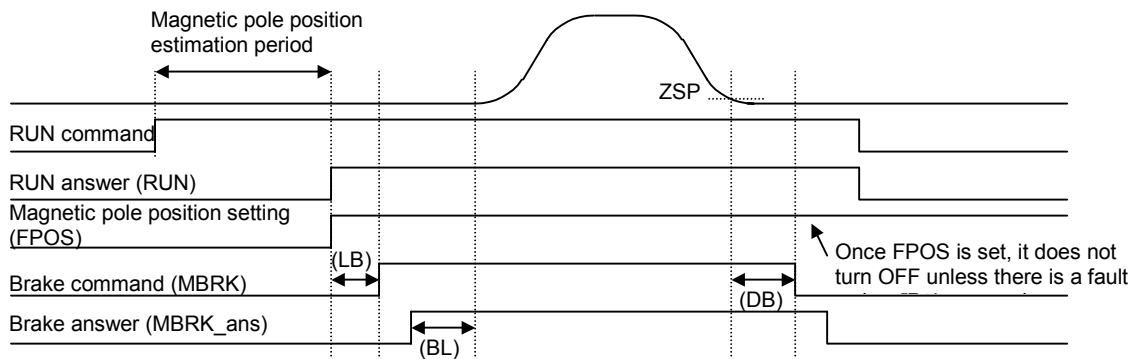

(8) Other settings and adjustments

This completes the adjustment of the magnetic pole position estimation function, setting of the external brake control function, and test operation.

Refer to Chapter 4 and set or adjust the sequence, etc., to match the user's application.

Refer to Section 6-9 for details on adjusting the PM motor vector control system parameters.

3-4-5 Automatic tuning error messages

If automatic tuning ends abnormally, the following message will appear. Investigate and confirm the state following the error code.

ALt-n
 ↑
 Automatic tuning step

No.	Cause and remedy
n=1	The motor may not be connected correctly. Check the connection. The B00 and B01 parameters may not be set correctly. Check the parameter setting. The motor with the special circuit constants may be applied. Change B19-1 and B19-2 parameters.
n=2	The B00 and B01 parameters may not be set correctly. Check the parameter setting.
n=3	The load and machine may not be separated. Separate the load and machine. Lengthen the acceleration time (A01-0). Lengthen the deceleration time (A01-1). If the motor vibrates, adjust the torque stabilizing gain (B18-2).
n=4	The load and machine may not be separated. Separate the load and machine. If the motor vibrates, increase the torque stabilizing gain (B18-2).
n=5	When the motor does not stop Increase the acceleration/deceleration time (A01-0, A01-1). When the motor does stop The B00 and B01 parameters may not be set correctly. Check the parameter setting.
n=6	The B00 and B01 parameters may not be set correctly. Check the parameter setting.
n=8	Indicates that the output voltage did not stabilize for 1 second or more during magnetic pole position estimation for the PM motor. Adjust the magnetic pole position estimation voltage (B39-1) and magnetic pole estimation time (B39-2).
n=9	Indicates that the PM motor magnetic pole estimation did not end normally even after retrying three times. Adjust the magnetic pole position estimation voltage (B39-1) and magnetic pole estimation time (B39-2).

Chapter 4 Operation Panel

4-1 Outline of operation panel types and functions

There are two types of operation panels which can be used with the VT240S, the LCD panel (V24-OP1) and LED panel (V24-OP2). The configuration of the operation panels are indicated below.

LCD panel (V24-OP1)

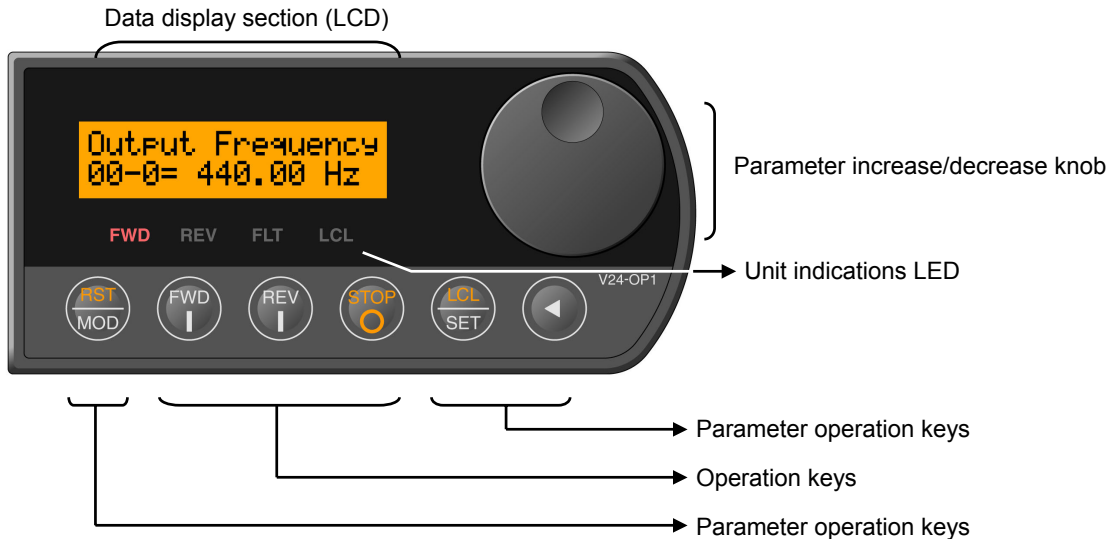

LED panel (V24-OP2)

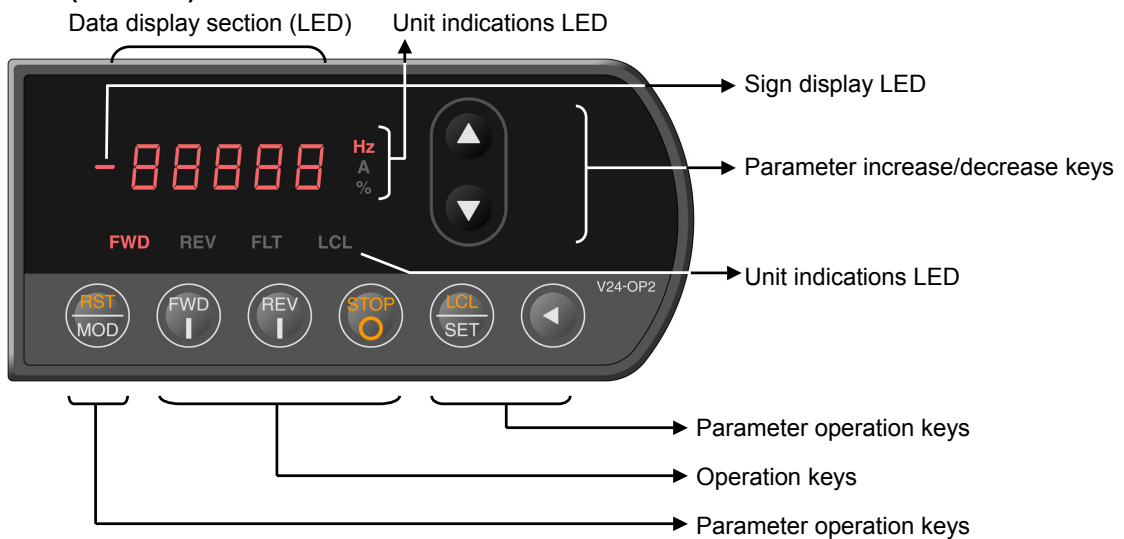















The functions of each section are shown in Table 4-1.

CAUTION

- A protective sheet is attached to the surface of the panel when shipped. Peel of this sheet before starting use.
- Do not drop the panel. The panel could break if strong impact is applied.
- If the display does not appear even when the inverter power is turned ON, the cable between the panel and inverter might not be connected properly. Check the connection.
- When using the operation panel away from the inverter by using an extension cable, do not place objects on the panel. The connector section could be damaged.

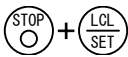
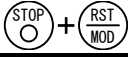



4. Operation Panel

Table 4-1 (1) Functions and operations of each operation panel section

Status indications LEDs		
FWD (Forward)	The drive is running in the forward direction.	When both LEDs flicker simultaneously, it indicates that DC Brake or pre-excitation is in action. If only the "FWD" or "REV" LED is flickering, this indicates that a command in the reverse direction has been received, and the drive is decelerating. Refer to section 4-1-3 for the relation with the operation keys.
REV (Reverse)	The drive is running in the reverse direction.	
FLT (Fault)	The drive has detected a fault and has stopped. Turns OFF when the  +  keys are pressed or the sequence input RESET signal is input.	
LCL (Local)	The drive is in the Local Mode and can be operated from the Operation Panel (FWD, REV and STOP only). When LED is off, the drive is in the Remote Mode and can be controlled from the terminal block (sequence input signals). To change Modes between Local and Remote, press  +  . Change this setting while operation is stopped.	
Unit indication LEDs (LED panel dedicated)		
	Indicates the unit of the parameter value shown on the display.	
Minus polarity indication LED (LED panel dedicated)		
	Lights when the number on the display is a minus number.	
Operation keys		
	Starts the drive in the forward direction. (in Local Mode only)	
	Starts the drive in the reverse direction. (in Local Mode only)	
	Stops the drive. The motor will either coast to a stop or ramp down to a stop as selected on C00-1.	
Held down for 2 sec. 	When this key is held down for two seconds or longer during operation, the motor will coast to stop. During LCL, the motor will first decelerate to a stop, and then coast to a full stop. During RMT, the motor will coast to a stop from the current output frequency/speed.	
	Changes control Modes from Local to Remote, or vice-versa. When the drive is in Local Mode, "LCL" LED is on. The drive is default set so that a Local/Remote selection is disabled while the drive is running. Even while the drive is at a stop, this selection cannot be made if operating commands such as RUN, JOG, etc., are being received at the terminal. This lock can be released with Parameter C09-2.	
	Resets a fault, putting out FLT LED.	
Parameter operation keys · Parameter operation knob		
	Changes the block No. mode displayed on the indicator in the following order each time the key is pressed: Monitor → Parameter A → Parameter B → Parameter C → Utility Mode U.	
	Fixes Parameter number or set its values.	
	Param. Select	When main & sub-No. selection method (C11-7=2) is selected for parameter setting method, moves from sub-No. selection to main No. selection.
	Valve change	Moves the digit to increment or decrement.

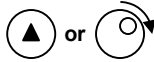
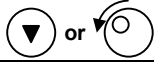
4. Operation Panel

Table 4-1 (2) Functions and operations of each operation panel section

Parameter increase/decrease key, parameter increase/decrease knob	
	Increases the parameter No. or parameter setting value.
	Decreases the parameter No. or parameter setting value.
	When the parameter is being set with the sub-No. selection method (C11-7=1), increases the parameter's main No.
	When the parameter is being set with the sub-No. selection method (C11-7=1), decreases the parameter's main No.
Operations dedicated for LED panel	
 Held down	Increases the parameter No. or setting value at a fast speed.
 Held down	Decreases the parameter No. or setting value at a fast speed.

4-1-1 Data display section on each panel

Each value display is explained in this section.

The LCD panel displays the characters, parameters and setting values with a 5*8 dot, 16-digit * 2-line LCD.

The LCD panel's LCD section is expressed with the following box in this manual.

<p style="margin: 0;">Output frequency</p> <p style="margin: 0;">D00-0: OFF. Hz</p>
--

The LED panel displays the parameters and setting values with a 7-segment 5-LED + sign display LED.

The LED panel's 7-segment section is expressed with the following display in this manual.

	<table border="1" style="border-collapse: collapse;"> <tr> <td style="padding: 2px 5px;">Hz</td> </tr> <tr> <td style="padding: 2px 5px;">A</td> </tr> <tr> <td style="padding: 2px 5px;">%</td> </tr> </table>	Hz	A	%
Hz				
A				
%				

4-1-2 Relation of RUN operation keys and status display LED

The status display LED turns ON, OFF or flickers according to the FWD and REV operation status.

Each operation is shown in the following figure.

Refer to the right drawing for the status of FWD and REV in the figure.

Status	Display
OFF	FWD REV
ON	FWD REV
Flicker	FWD REV

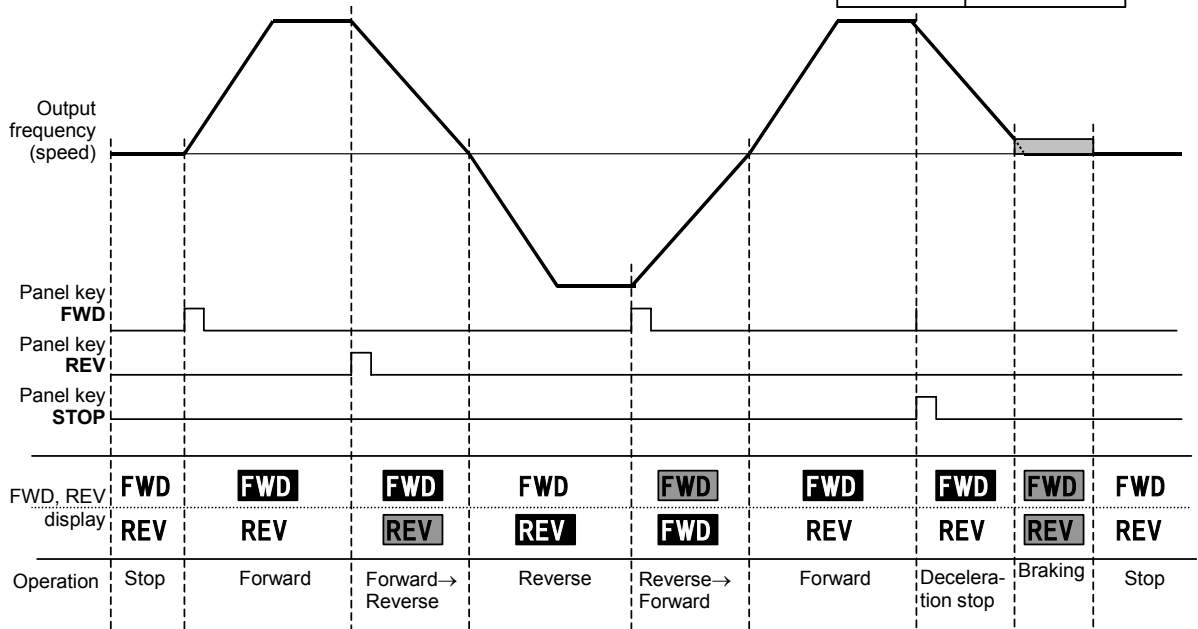

Fig 4-1-2 Relation of panel key, RUN operation and FWD, REV

4-1-3 Selecting the operation method

Two operation methods can be selected with the operation panel by setting the parameters. The parameters to be set and the operation methods are explained below.

C11-7: Operation panel operation method selection

=1: Sub-No. selection method

Increase or decrease the parameter's sub-No. with the ▲▼ keys or ⌚.

If the sub-No. exceeds the maximum value or minimum value, the main No. will increase or decrease by 1.

This method is easy to use when holding the panel in hand and operating.

* This method is the default method.

=2 Main & sub-no. selection method

The parameter is set by setting both the main No. and sub-No.

After entering the main No., press the ⌚ key to enter the sub-No. selection.

If the sub-No. exceeds the maximum value or minimum value, the number will loop within the sub-No.

This method is easy to use when the operation panel is mounted on the inverter, and the buttons and knobs are operated.

Set the operation method according to the working environment.

4-1-4 Panel display at power ON

The state when the power is turned ON with the panel connected to the inverter is explained in this section.

The LED panel is explained in 3-4-1. Automatic Tuning and Test Operation, so refer to that section.

The LCD panel startup screen is shown below.

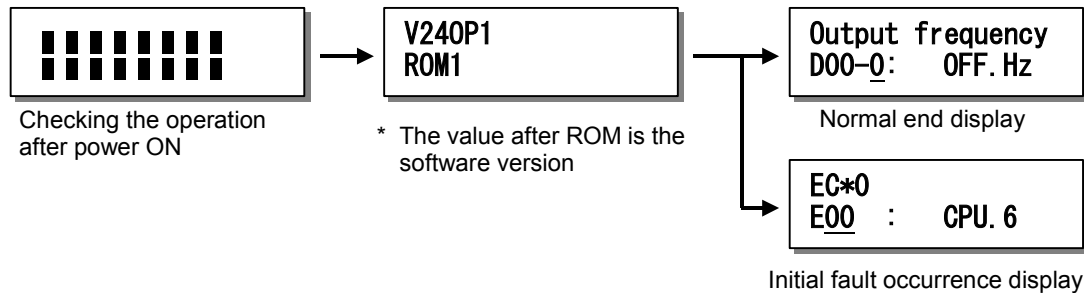

If there is a cause of a fault when the power is turned ON, the initial fault occurrence display will appear.

In this case, remove the cause of the fault, and then reset by pressing + .

The state will be checked again, and if the check ends normally the normal end display will appear.

CAUTION

- If the normal end or initial fault occurrence screen does not appear even after 10 seconds, check the following points.
 - 1) Are the panel and inverter connected correctly?
Remove the panel once, and securely connect it.
 - 2) Is the cable connecting the PCB in the inverter and the panel disconnected?
Check and securely insert the connector.
- If the problem cannot be resolved with method 1) or 2), there may be an error in the inverter's internal circuit. Turn the power OFF immediately.

4-2 Various operations and displays when LCD panel is connected

The various operation and displays when the LCD panel starts up correctly are explained in this section. First, the various operations and displays for the operation method C11-7=1 Sub-No. selection method are explained.

4-2-1 Details of data display section

The outline of the Main screen is shown below.

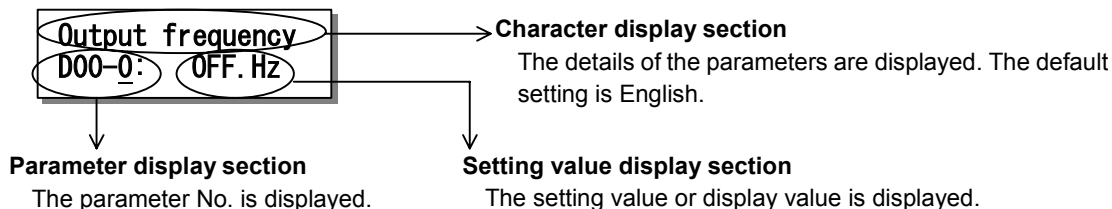

The parameter numbers are categorized in the following manner in this manual.

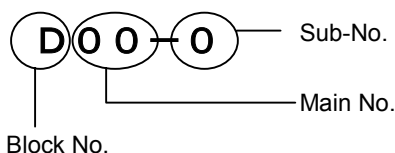

4-2-2 Operating and displaying the character display section

The character display section starts left scrolling after two seconds. When the last character is displayed, the display remains for two seconds, and then the first display appears.

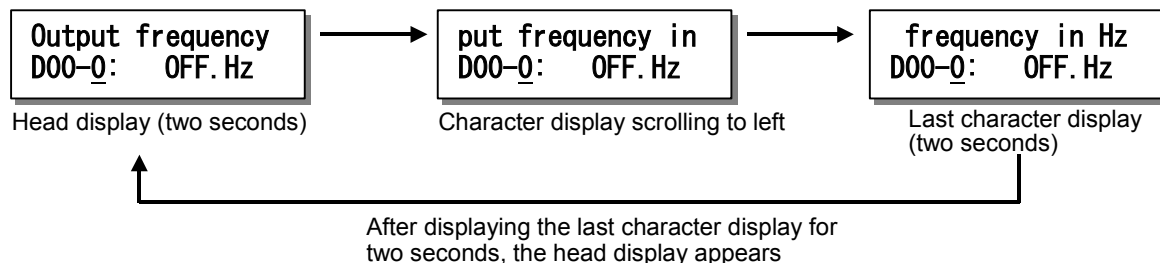

The character display can be selected from five languages, English, French, Italian, Spanish or German. Change the language with the parameter C11-4 setting value.

The default language is English.

Refer to section 4-2-5 Setting value operation and display for details on changing the setting value.

4-2-3 Operating and displaying parameter numbers

If the parameter increase/decrease knob at the right of the panel is turned when the underbar is flickering at the parameter No., the digit where the underbar is flickering will increase or decrease. When the parameter increase/decrease knob is turned right, the digit will increase by one with one count, and when turned left, will decrease by one with one count.

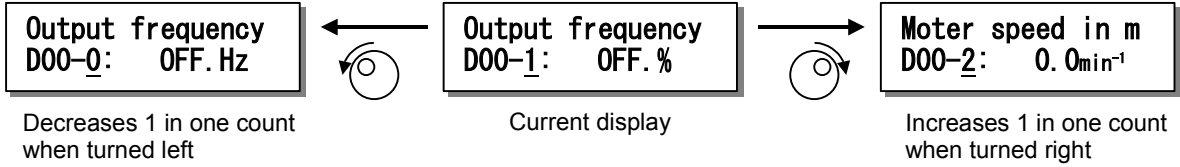

When changing the parameter No., first only the changed parameter No. is displayed. After one second, the character display and setting value will appear. When changing the D monitor parameters, the display value will appear.

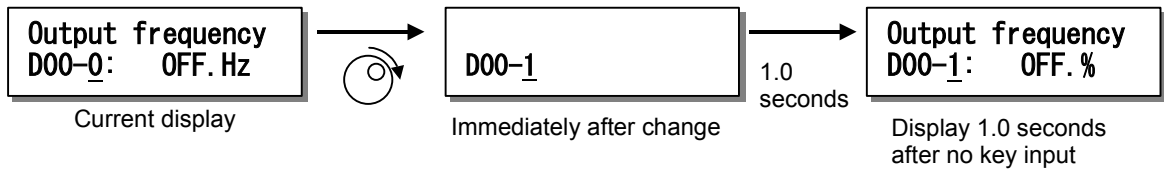

4-2-4 Changing the block No.

If the  key is pressed when the parameter No. is displayed or when setting the setting value, the block will change in the order of D → A → B → C → U → D.

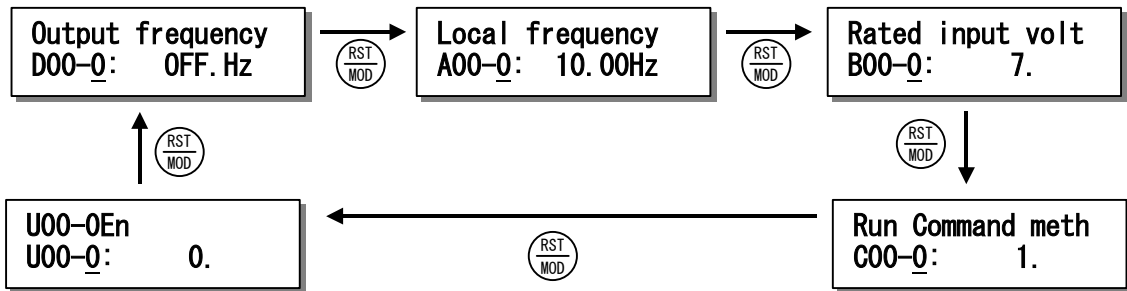

4-2-5 Operating and displaying setting values

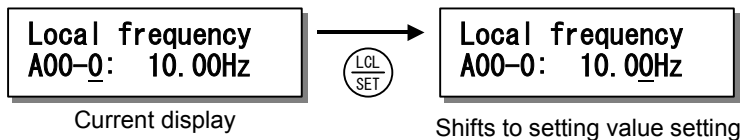

If the  key is pressed when the Block- A, B, C or U is displayed, the operation will shift to the setting value setting. The underbar moves to the last digit of the setting value.



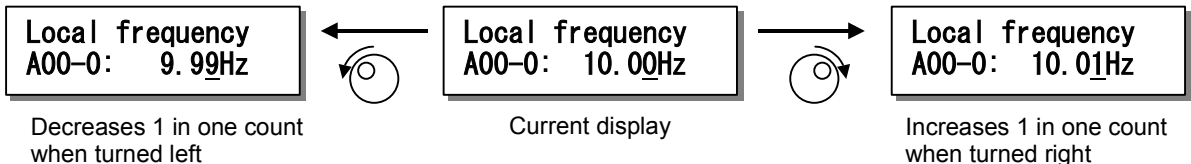

When setting the setting value, the value can be increased and decreased by turning the parameter increase/decrease knob.



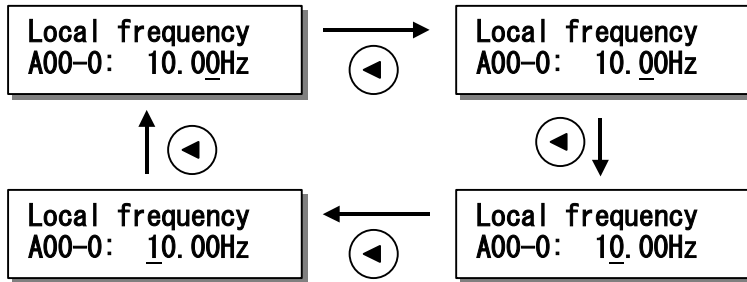

4. Operation Panel

When the  key is pressed, the flickering underbar can be moved one digit to the left.
 If the  key is pressed when the flickering underbar is at the top digit, it will move to the last digit.

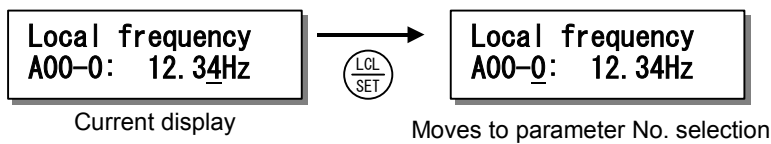

When the setting value has been decided, press the  key again to enter the setting value.
 The underbar will move to the parameter No.



To return to the parameter No. selection without changing the parameter with setting value setting, press the  key.

The display will change to the next block No. If the parameter for which the setting value was being changed is moved to, the setting value will return to the original value.

Note that the value will not return for A00-0: direct frequency setting and A00-2: direct speed setting.

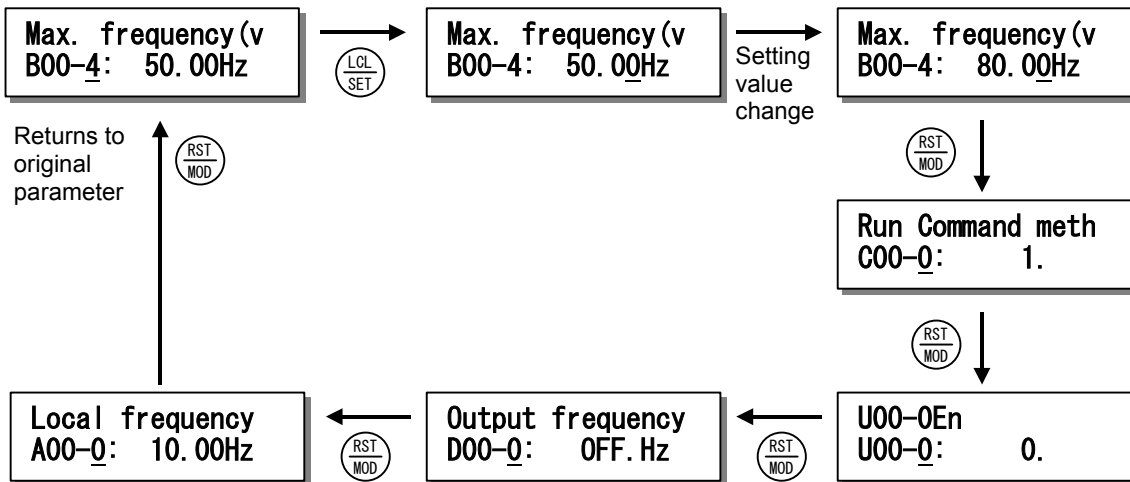

4-2-6 Operating and displaying parameter numbers with main and sub-No. selection method

An example of operations when C11-7=2: main & sub-No. selection method is explained in this section. When using the main & sub-No. selection method, the method for setting the underbar and parameter No. differs from the sub-No. selection method. A figure is shown below.

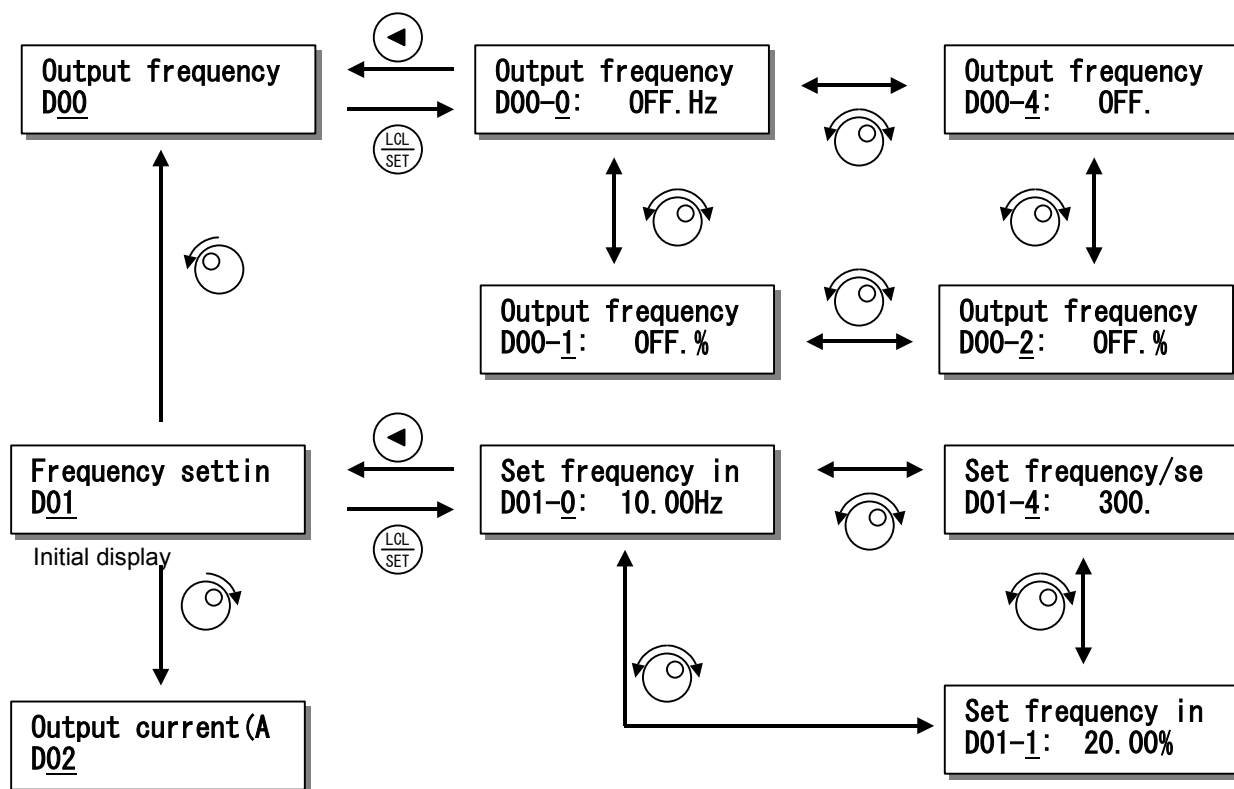

With this method, if the underbar is at the parameter number's sub-No. and the parameter increase/decrease knob is turned, the main No. will not change, and only the sub-No. will change.

To move from the sub-No. selection to the main No., press the ◀ key. The underbar will move to the main No.

If the parameter increase/decrease knob is turned when the underbar is at the main No., the main No. will be changed.

To move from the main No. selection to the sub-No. selection, press the LCL/SET key. The underbar will move to the sub-No.

If the LCL/SET key is pressed again when the sub-No. is selected, the display will change to the setting value setting.

Refer to section 4-2-5 operating and displaying the setting value, and set the setting value.

4-2-7 Displaying the sequence

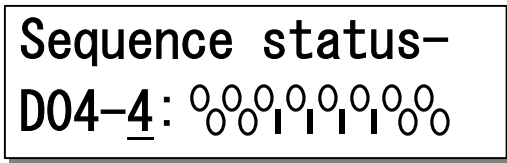

With the LCD panel, the D04-0 to 3: sequence input and D04-4 to 7: sequence output are displayed as shown below. The D04-4: Sequence output 1 is shown as a display example.

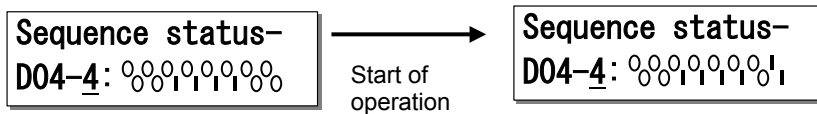

- and | indicate the status of the corresponding sequence.
 - : Sequence OFF
 - | : Sequence ON
 - and | are updated immediately when the sequence status changes.
- Example** : Start of operation (Sequence output: RUN, ATN ON)



4-2-8 Displaying the fault history

When the parameter is set to D20-0 and the  key is pressed, the fault history display will appear. To return to the parameter selection from the fault history display status, press the  key again, or press the  key.

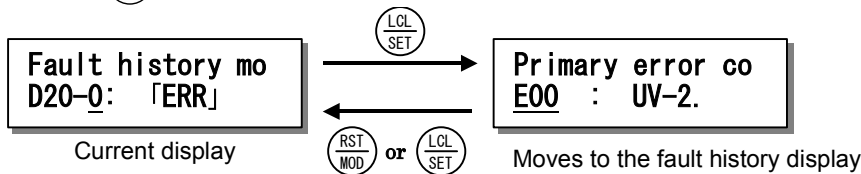

If the parameter increase/decrease knob is turned in the fault history display status, the numbers will loop between E00 and E37, and the fault corresponding to the number will display. Refer to section 4-3-7 Fault history display for details on E00 to E37.

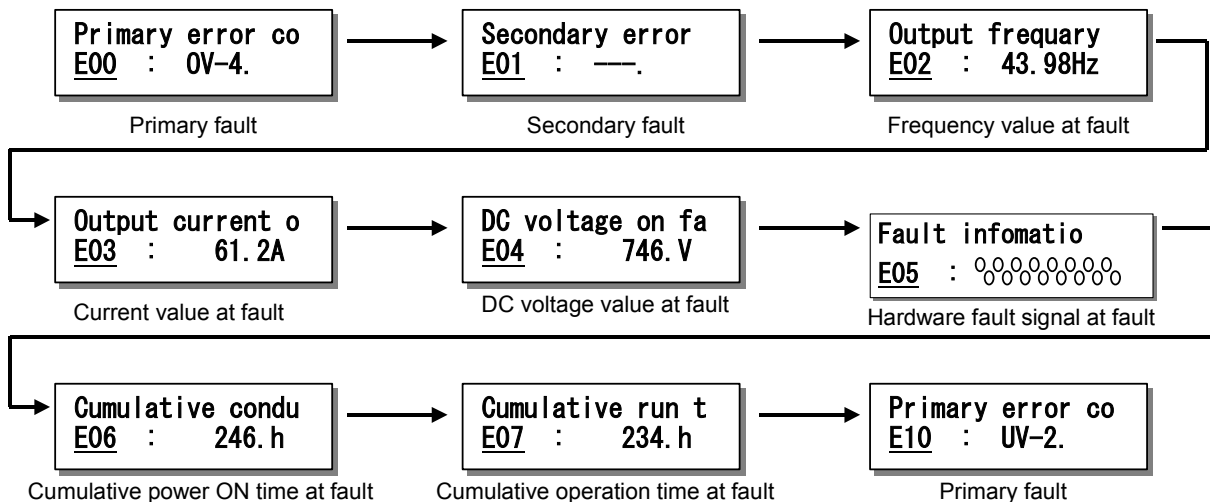

4-2-9 Operating and displaying during Block-A, B, C parameter change list selection

If the  key is pressed when the parameter is set to D20-2, the Block-A, B, C parameter change list will appear.

Press the  key to return to the parameter selection from the Block-A, B, C parameter change list display.

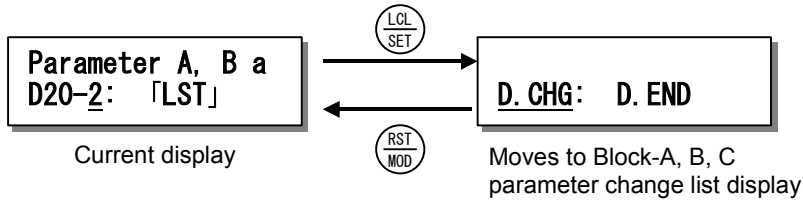

If the parameter increase/decrease knob is turned while the Block-A, B, C parameter change list is displayed, the parameters which were set or changed after power ON will appear in sequence.

If the  key is pressed in this state, the display will change to parameter setting value setting.

The setting value can be changed in this state.

If the  key is pressed again, the change list will reappear.

If the parameter increase/decrease knob is pressed to the last of the changed parameters, "D.CHG: D.END" will appear.

If the parameter increase/decrease knob is pressed further, the first parameter will appear.

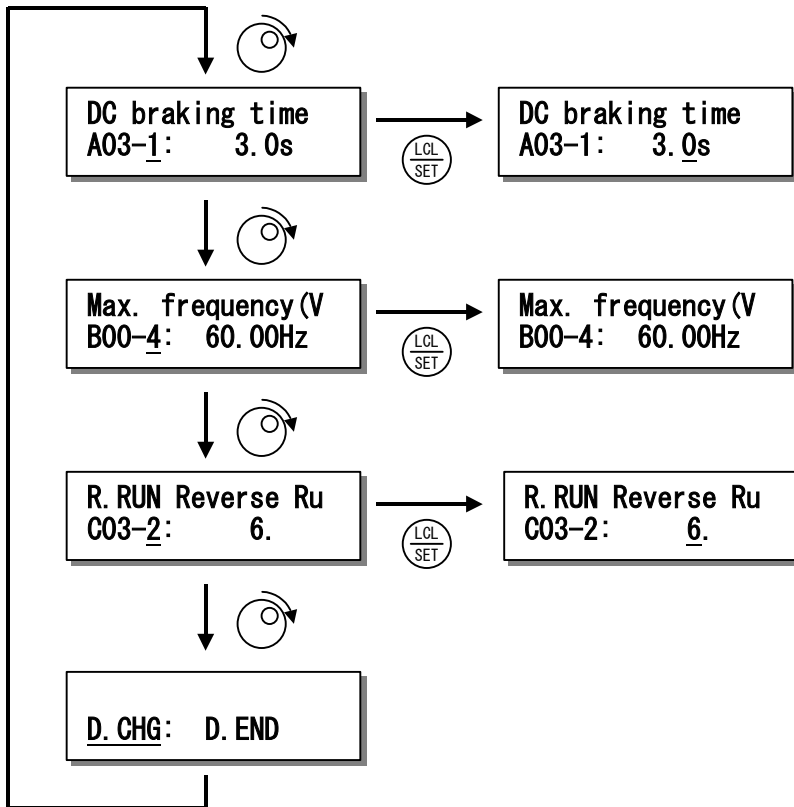



4-2-10 Displaying the LCD panel dedicated sequence characters

If the  key is pressed when the parameter is set to D20-3 or 4, the sequence input or output display will appear. The parameter No. and target are shown below.

- D20-3 : Sequence input
- D20-4 : Sequence output

The D20-4 sequence output is explained as an example in the following section. The operations are the same for D20-3 and 4.

To return to parameter selection, press the  key or  key.

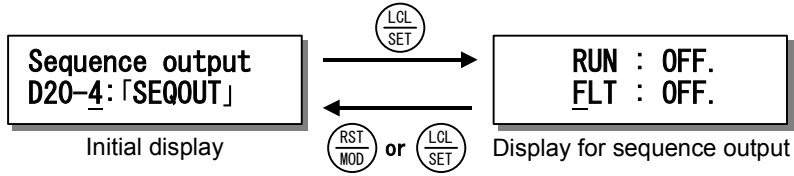

If the parameter increase/decrease knob is turned while the sequence details are displayed, the display will move up and down.

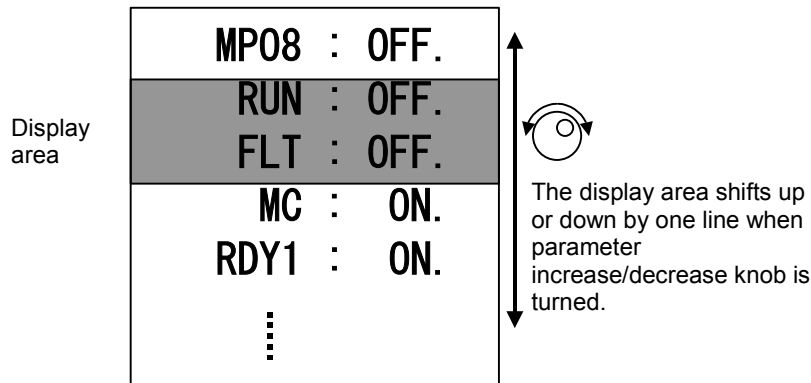

Refer to Chapter 6 List of Parameters for the names of the displayed sequences.

The ON and OFF status is updated immediately when the sequence status changes.

Example : Start of operation (Sequence output: RUN is ON)

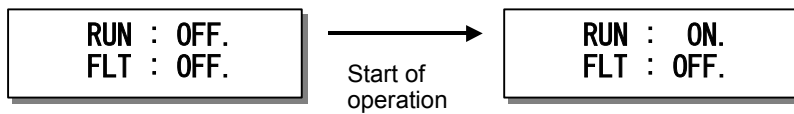

4-2-11 LCD panel display at fault occurrence, and resetting methods

When a fault occurs in the inverter, the following type of display will appear on the LCD panel.

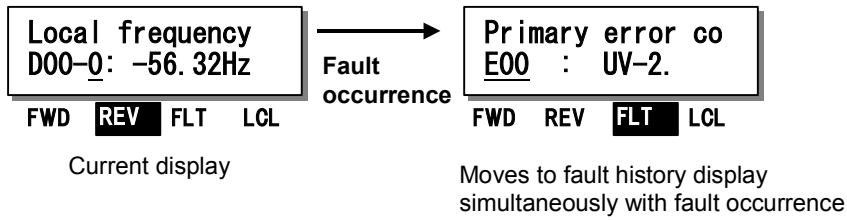



When a fault occurs, the inverter operation stops, and the "FLT" LED on status display LED turns On. At the same time, the head "E00" for the fault history and the fault code appear on the LCD panel. The cause of the fault is indicated at the fault code displayed at E00 to E07. Refer to Appendix Table 3 Fault codes for details on the fault codes. In the above figure, an undervoltage occurred during constant speed operation and a fault occurred. If the parameter increase/decrease knob is turned while the history is displayed, the fault details can be displayed in the range of E00 to E37.

To return to the normal parameter selection from the fault history display, press the  key.

Resetting a fault:

Refer to the details of E00 to E07 in the fault history display and the Appendix Table 3 Fault code table, and remove the cause of the fault.

The FLT LED will turn OFF when the  +  keys are pressed or the sequence input RESET is turned ON.

Refer to Chapter 5 section 5-3 Programmable sequence input function (PSI) for details on resetting the fault with the sequence input RESET.

The display in this case is shown below.

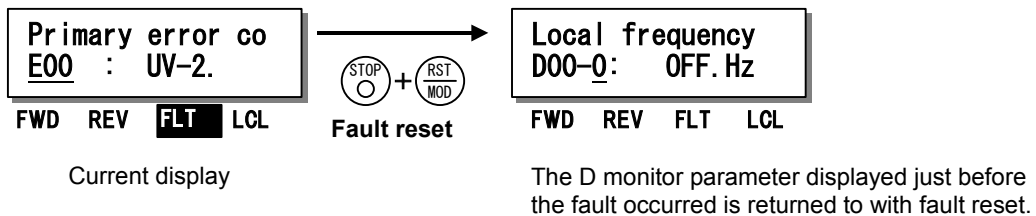

When the fault is reset, the LCD panel display will return to the D monitor parameter from the fault history state.

Confirm that the cause of the fault has been removed, and then resume operation.

 **CAUTION**

- Confirm that the sequence output RDY1 and RDY2 are ON before resuming operation.

4-3 Various operations and displays when LED panel is connected

The various operation and displays when the LED panel starts up correctly are explained in this section. Refer to Chapter 3 section 3-4-1. Automatic Tuning and Test Operation for V/f control for details on the display when the power is turned ON.

First, the various operations and displays for the operation method C11-7=1 Sub-No. selection method are explained.

4-3-1 Operating and displaying the parameter No.

The methods for operating the parameter No. are shown below. Refer to Table 4-1 for details on the key functions.















<Keys>	<Display, unit LED>	<Explanation>
After viewing the output current with a [%] unit, the parameter which displays the output frequency with a [Hz] unit is displayed.		
		D00-0 : Output frequency
◀ + ▲		The main No. increases.
◀ + ▲		The main No. increases.
▲		The sub-No. increases. D02-1 is displayed.
↓		After one second, the display will show the output current as a percentage.
◀ + ▼		The main No. decreases.
◀ + ▼		The main No. decreases.
↓		After one second, the display will show the output frequency as Hz.

When operating with the sub-No. selection method, the third decimal point dot turns ON while the ◀ key is pressed to indicate that the main No. is being changed.

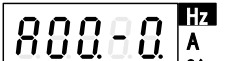
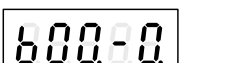
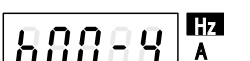
Press the key to check the parameter No. with the monitor display.

4-3-2 Operating and displaying the setting value

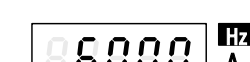
Refer to Sections 6-2 to 6-5, for the details of the Block-A, B and C parameters.

<Keys>	<Display, unit LED>	<Explanation>
Change the Parameter: B00-4 maximum output frequency (Fmax) from 50.0 to 60.0		
<p>(In Monitor Mode)</p> <p>Three times </p> <p>Three times </p> <p>Three times </p> <p>Three times </p> <p>Three times </p> <p>Three times </p> <p>Three times </p>	<p></p> <p></p> <p></p> <p></p> <p>↓ ↑</p> <p></p> <p></p> <p></p> <p></p> <p></p> <p>↓ ↑</p> <p></p>	<p>(In Monitor Mode)</p> <p>Changes to the Block-A Parameter setting Mode.</p> <p>Changes to the Block-B Parameter setting Mode.</p> <p>Increase the parameter No. from parameter B00-0 to B00-4.</p> <p>The display will alternate between Parameter Number B00-4 and the present setting value 50.00.</p> <p>Enable the value to be changed. The preset setting value will display.</p> <p>Press  three times to move the flicker to the digit that is to be changed. (Note: Parameter B00-4 cannot be changed while the inverter is running.)</p> <p>Change the flicker digit from 5 to 6.</p> <p>Fix the data. Changing of Parameter B00-4 to 60.0 will be completed.</p> <p>The display will alternate between parameter No.: B00-4 and current setting value: 60.00.</p>

4. Operation Panel

<Keys>	<Display, unit LED>	<Explanation>
Change the parameter A03-1 (DC Breaking Time) from 2.0 (default value) to 3.5.		
		(In B00-4 Parameter Setting Mode)
RST MOD		Changes to the Block-C Parameter Setting Mode.
RST MOD		Changes to the Utility Mode. (For future use)
RST MOD		Changes to the Monitor Mode.
RST MOD		Changes to the Block-A Parameter Setting Mode.
◀ + ▲		
◀ + ▲		Increase the Parameter Block Number from A00-0 to A03-1.
◀ + ▲		Increase the Parameter Number.
▲		
	↓ ↑	The display will alternate between Parameter Number A03-1 and the present value 2.0.
		Enable the value to be changed. The preset setting value will display.
▲		Change the flicker digit from 0 to 5.
Five times		Move the flickering digit to the digit to be changed
		Change the flicker digit from 2 to 3.
		Fix the data. Changing of parameter A03-1 to 3.5 will be completed.
	↓ ↑	
		The display will alternate between the Parameter Number A03-1 and the present value. (Parameter Number Changing Mode.)

(Note) If the **RUN** (RUN) display appears when changing from the parameter No. to the setting No. change state, the parameter is one that can be changed only while the inverter is stopped.

4-3-3 Operating the monitor parameters with the main & sub-No. selection method

- (1) The method for operating the parameters with the C11-7=2 : main & sub-No selection method is shown below.



















<Keys>	<Display, unit LED>	<Explanation>
After viewing the output current with a [%] unit, the parameter which displays the output frequency with a [Hz] unit is displayed.		
		D00-0 : Output frequency
		Changes to the main No. selection.
		The main No. increases.
		The main No. increases.
		Changes to the sub-No. selection.
		The sub-No. increases. D02-1 is displayed.
	↓	
		After one second, the display will show the output current as a percentage.
		The main No. decreases.
		The main No. decreases.
	↓	
		After one second, the display will show the output frequency as Hz.

When operating the parameters with the main & sub-No. selection method, the third decimal dot turns ON while the parameter is selected to differentiate between the sub-No. selection method.

Press the  key to check the parameter No. during the monitor display.

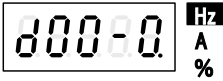
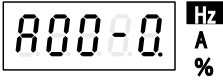
4-3-4 Changing the Block-A, B, C parameters with main & sub-No. selection method

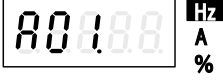
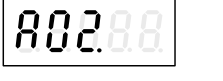
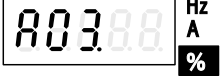
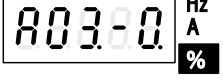
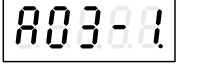
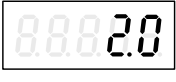
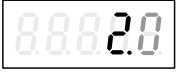
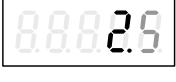
(1) Refer to Sections 6-2 to 6-5, for the details of the Block-A, B and C parameters.

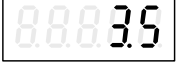
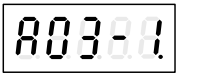
<Keys>	<Display, unit LED>	<Explanation>
Change the parameter A03-1 (DC Breaking Time) from 2.0 (default value) to 3.5.		
         Five times     	        ↓ ↑       ↓ ↑ 	<p>(In D00-0 Parameter Setting Mode)</p> <p>Changes to the Block-A Parameter Setting Mode.</p> <p>Changes to the main No. selection.</p> <p>The main No. increases.</p> <p>The main No. increases.</p> <p>The main No. increases.</p> <p>Changes to the sub-No. selection.</p> <p>The sub-No. increases.</p> <p>The display will alternate between Parameter Number A03-1 and the present value 2.0.</p> <p>Enable the value to be changed. The preset setting value will display.</p> <p>Change the flicker digit from 0 to 5.</p> <p>Move the flickering digit to the digit to be changed</p> <p>Change the flicker digit from 2 to 3.</p> <p>Fix the data. Changing of parameter A03-1 to 3.5 will be completed.</p> <p>The display will alternate between the Parameter Number A03-1 and the present value. (Parameter Number Changing Mode.)</p>

4. Operation Panel

(Note) If the **RUN** (RUN) display appears when changing from the parameter No. to the setting No. change state, the parameter is one that can be changed only while the inverter is stopped. With the main & sub-No. selection method, if the sub-No. increases from the maximum state or decreases from the minimum state, it will loop within the same main No. The operation is summarized in the following figure. (D10: Simple PLC monitor is shown as an example.)

Press the  key to return to the main No. selection.

Press the  key to move to the setting value setting.

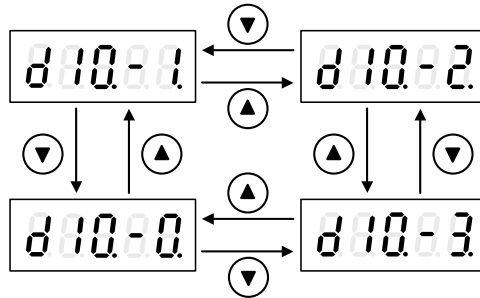

4-3-5 Changing the block No.

The operation panel block No. will change between five modes each time the  key is pressed. The monitor mode D20-0, 1, 2 is the entry to the extended monitor mode.

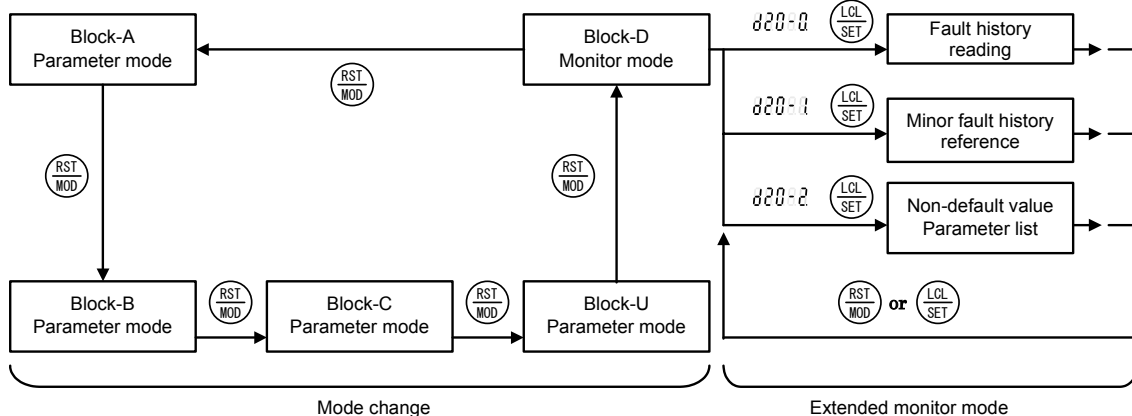

4-3-6 Displaying the sequence

With the LED panel, the D04-0 to 3: sequence input and D04-4 to 7: sequence output are displayed as shown below. The D04-4: Sequence output 1 is shown as a display example.

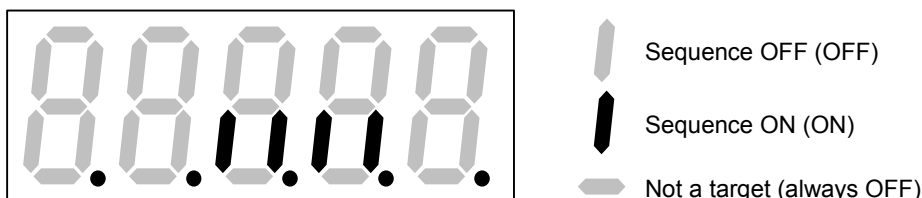









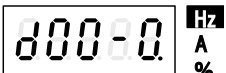
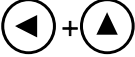

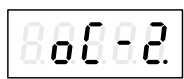

When the corresponding sequence turns ON, the LED on the LED panel turns ON. The decimal point LED flickers at a one-second cycle.

Each LED display is updated as soon as the sequence changes in the same manner as the LCD panel.

4-3-7 Fault History Display

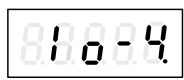
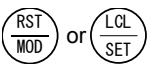
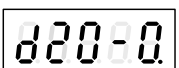
Refer to Appendix Table 3 Fault Code Table for the fault codes and details.

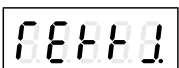
<Keys>	<Display, unit LED>	<Explanation>
		<p>(d00-0 will display in the Monitor Mode.)</p>
		<p>Select Monitor Parameter d20-0.</p>
	<p style="text-align: center;">↓</p>	
		<p>The [ERR] symbol will display after one second.</p>
		<p>Enter the Faulty History Reference Mode by pressing the  key.</p>
	<p style="text-align: center;">↓ ↑</p>	
		<p>The fault history number (E00 to E37) and the fault code will display alternately.</p>
		<p>Refer to the contents of the fault buffer by pressing the   keys.</p>
	<p style="text-align: center;">↓ ↑</p>	
		
		<p>End the Fault history Mode and return to the Monitor Mode by pressing the  key or  key.</p>
	<p style="text-align: center;">↓</p>	
		<p>The [ERR] symbol will display after one second.</p>

4. Operation Panel

The fault history display has the following type of configuration.
The faults up to the previous faults are listed as display examples.













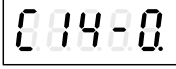
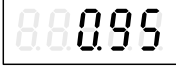

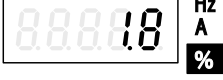
Fault sequence	Fault history No.	Display	Explanation
Fault 1 (The latest)	E00	00-2	Primary cause fault (overcurrent)
	E01	10-4	Secondary cause fault (retry over)
	E02	52.24	Output frequency at fault
	E03	1049	Output current at fault
	E04	404	DC voltage at fault
	E05	ASIC fault at fault
	E06	13582	Cumulative power ON time at fault
	E07	9284	Cumulative run time at fault
Fault 2	E10	00-2	Primary cause fault (undervoltage)
	E11	----	Secondary cause fault (none)
	E12	6000	Output frequency at fault
	E13	870	Output current at fault
	E14	210	DC voltage at fault
	E15	ASIC fault at fault (no display)
	E16	8632	Cumulative power ON time at fault
	E17	3657	Cumulative run time at fault
Fault 3	E20	----	"----" indicates that a fault is not recorded. The frequency value, voltage value, current value, cumulative power ON time and cumulative run time values are all 0 when no fault is recorded. * E00 to E37 are all ---- or 0 in the default state.
	E21	----	
	E22	000	
	E23	00	
	E24	0	
	E25	
	E26	0	
	E27	0	
Fault 4	E30	----	
	E31	----	
	E32	000	
	E33	00	
	E34	0	
	E35	
	E36	0	
	E37	0	

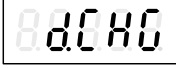
4-3-8 Operations and display when Block-A, B, C parameter change list is selected

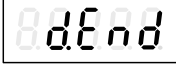
Monitor parameter D20-2 is an entry into the Block-A, B, C parameter change list mode. In this change list mode, only the Block-A, B, C parameters which differ from the default values can be referred to and changed.

<Keys>	<Display, unit LED>	<Explanation>
An example of referring to the change list and changing C14-0 (FM output gain) is shown below.		
		(Monitor mode initial display)
		The block No. and parameter No. increases from parameter D00-0 to D20-2. Refer to sections 4-3-3 or 4-3-5 for these operations.
		One second after D20-2 is selected, "LST" will appear.
		The change list mode is entered when the key is pressed.
		The number of the parameter (A03-1) which has been changed from the first setting value and the current setting value will alternately display.
		Next, the changed parameter will appear.
		The parameters which differ from the setting values can be displayed in order by pressing the key.
		The parameters which differ from the setting values can be displayed in order by pressing the key.
		Display parameter: C14-0 (A01 output gain).
		Select parameter C14-0. The setting value change status will be entered.
		Set the data. Change parameter C14-0 to 0.95.

4. Operation Panel

<Keys>	<Display, unit LED>	<Explanation>
  	 ↓ ↑    ↓ ↑        ↓ 	<p>The parameter No. and current setting value will alternately display.</p> <p>The parameters which differ from the setting values can be displayed in order by pressing the  key.</p> <p>d.CHG and d.END will alternately display to indicate the end of the change list.</p> <p>When the  key is pressed, the change list will display from the start.</p> <p>If the  key is pressed in the parameter change state, the change list display mode will end. The monitor parameter selection status will be entered. ("LST" will appear after one second.)</p>

4-3-9 LED panel display at fault occurrence, and resetting methods

When a fault occurs in the inverter, the following type of display will appear on the LED panel.

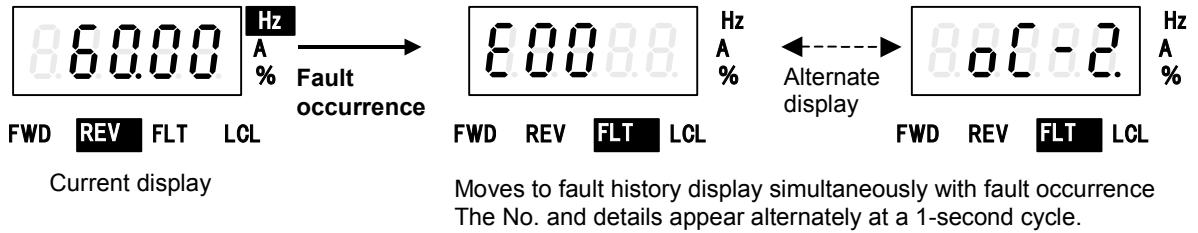

When a fault occurs, the inverter stops operation, and the "FLT" status display LED on the panel will turn ON.

At the same time, the head "E00" for the fault history and the fault code appear on the LED panel.

The cause of the fault is indicated at the fault code displayed at E00 to E07.

Refer to Appendix Table 3 Fault codes for details on the fault codes.

In the above figure, an overvoltage occurred during constant speed operation and a fault occurred.

If the \uparrow \downarrow keys are pressed while the history is displayed, the fault details can be displayed in the range of E00 to E37.

To return to the normal parameter selection from the fault history display, press the $\text{\textcircled{RST MOD}}$ key.

Resetting a fault:

Refer to the details of E00 to E07 in the fault history display and the Appendix Table 3 Fault code table, and remove the cause of the fault.

The FLT LED will turn OFF when the $\text{\textcircled{STOP}}$ + $\text{\textcircled{RST MOD}}$ keys are pressed or the sequence input RESET is turned ON.

Refer to Chapter 5 section 5-3 Programmable sequence input function (PSI) for details on resetting the fault with the sequence input RESET.

The display in this case is shown below.

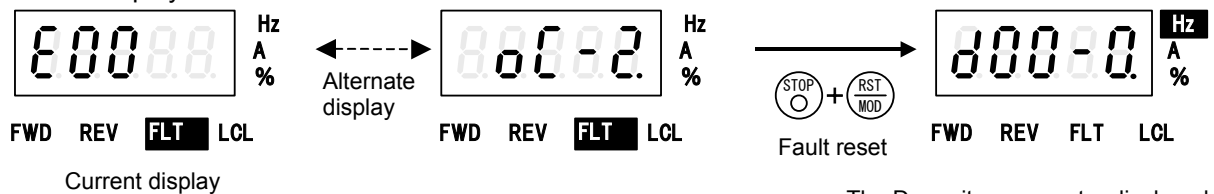

When the fault is reset, the LED panel display will return to the D monitor parameter from the fault history state.

Confirm that the cause of the fault has been removed, and then resume operation.

CAUTION

- Confirm that the sequence output RDY1 and RDY2 are ON before resuming operation.

4-4 Customizing block-B, C parameter

Block-B, C parameters can be assigned to any Block-A Parameter in the range of A04-0 to A04-7, and can be read and changed in the Block-A Parameter Setting Mode.

To use this function, set parameter No. to be displayed in A04-0 to 7 in parameter C10-0 to 7.

The case for the V/f control (C30-0=1) of control selection (C30-0:f0) is shown below.

The operation example applies when the LED panel is connected.

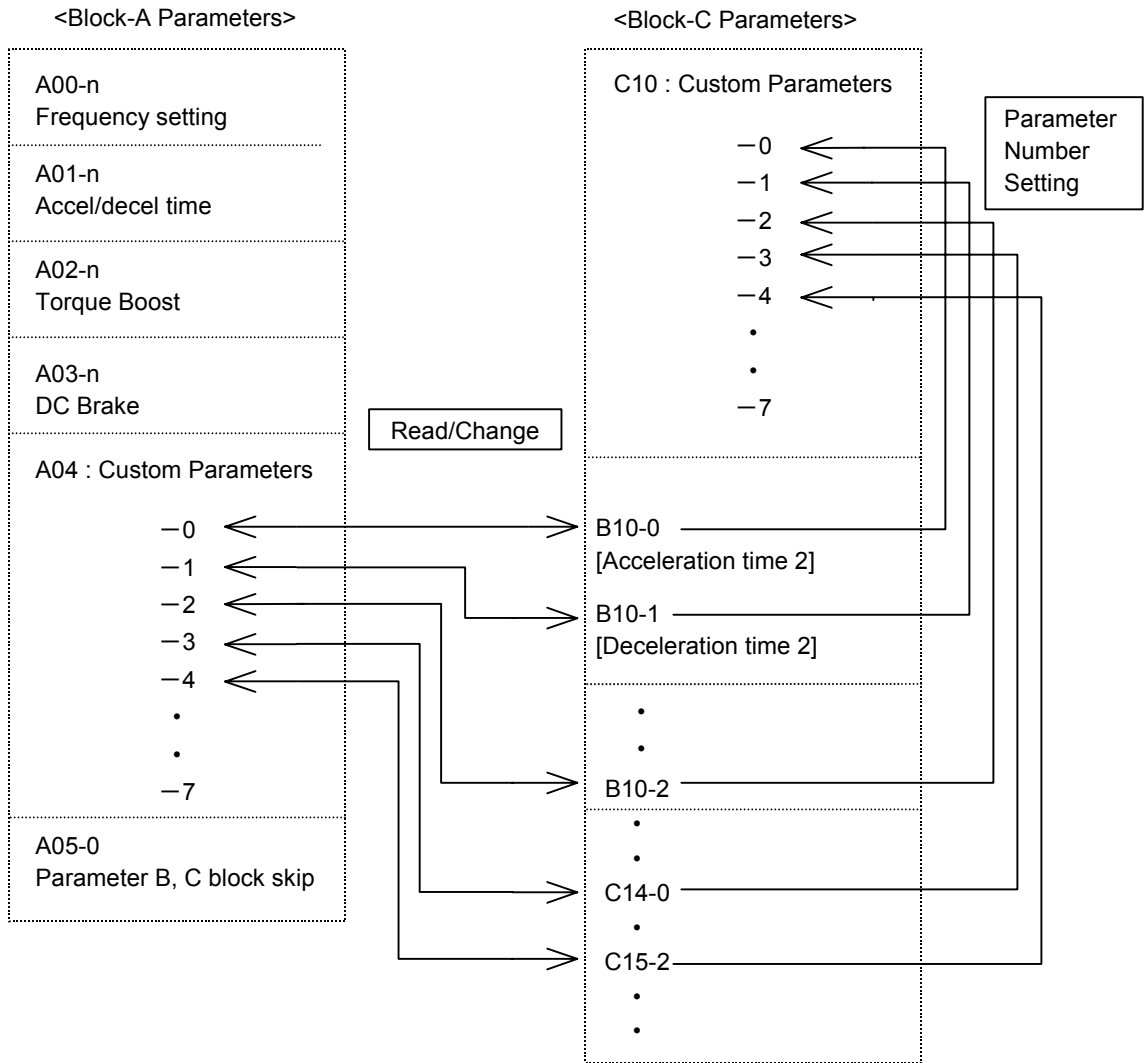

An example of selecting the custom parameter and changing the selected custom parameter setting value is given on the following page.

4. Operation Panel

<Keys>	<Display, unit LED>	<Explanation>
Register parameter B10-0 on Parameter C10-0 (Custom Setting).		
<div style="display: flex; flex-direction: column; align-items: center; gap: 10px;"> <div style="display: flex; gap: 10px;"> <div style="border: 1px solid black; padding: 2px;">010-0</div> <div style="text-align: center;">↓ ↑</div> <div style="border: 1px solid black; padding: 2px;">819F.F</div> </div> <div style="display: flex; flex-direction: column; align-items: center; gap: 10px;"> <div style="border: 1px solid black; padding: 2px;">819F.F</div> <div style="border: 1px solid black; padding: 2px;">8198.0</div> <div style="border: 1px solid black; padding: 2px;">8170.0</div> <div style="border: 1px solid black; padding: 2px;">8110.0</div> <div style="text-align: center;">↓ ↑</div> <div style="border: 1px solid black; padding: 2px;">010-0</div> </div> </div>	<p>(Mode and Parameter Number Change to C10-0)</p> <p>The display shows Parameter C10-0. (Setting value 1.9F.F is the initial setting, and indicates that nothing has been selected.)</p> <p>The C10-0 setting value setting is started by pressing the key.</p> <p>Set the parameter B10-0 sub-No. to "0".</p> <p>The flickering digit will move when the key is pressed.</p> <p>Set so that the high-order digit is block No. 10. When the key is pressed, the data will be set, and the parameter selection screen will appear.</p> <p>(Note) For parameter C, set as 2.xx.x.</p>	
Change parameter B10-0 that has been assigned to A04-0.		
<div style="display: flex; flex-direction: column; align-items: center; gap: 10px;"> <div style="display: flex; gap: 10px;"> <div style="border: 1px solid black; padding: 2px;">A00-0</div> <div style="text-align: center;">↓ ↑</div> <div style="border: 1px solid black; padding: 2px;">A04-0</div> </div> <div style="display: flex; flex-direction: column; align-items: center; gap: 10px;"> <div style="border: 1px solid black; padding: 2px;">8810.0</div> <div style="border: 1px solid black; padding: 2px;">8810.5</div> <div style="border: 1px solid black; padding: 2px;">8810.5</div> <div style="text-align: center;">↓ ↑</div> <div style="border: 1px solid black; padding: 2px;">A04-0</div> </div> </div>	<p>Enter the Block-A Parameter Setting Mode.</p> <p>The Custom Parameter Number A04-0 will display.</p> <p>The display will alternate between Parameter Number A04-0 and the value of Parameter Number B10-0 (Acceleration cushion time 2). Parameter Number A04-0 is the same value as that of Parameter Number B10-0.</p> <p>When the key is pressed, the B10-0 setting value setting state will be entered.</p> <p>Change the value.</p> <p>When the key is pressed, the data will be set, and the parameter selection screen will appear.</p>	

Note) If an undefined parameter No. such as the default 1.9F.F is set for C10-n, it will be interpreted that a custom setting has not been made, and the A04-n display will be automatically set.

4-5 Changing modes

The parameters used differ according to the control mode (C30-0:f0).

The parameters include the V/f control, the IM vector control (sensor-less, with sensor) and the PM motor control with sensor.

These parameters are divided into the block No. (mode), main No. and sub-No. for each function.

4-5-1 V/f control (C30-0 f0 = 1) mode

The configuration of the parameters is shown in Fig. 4-5-1.

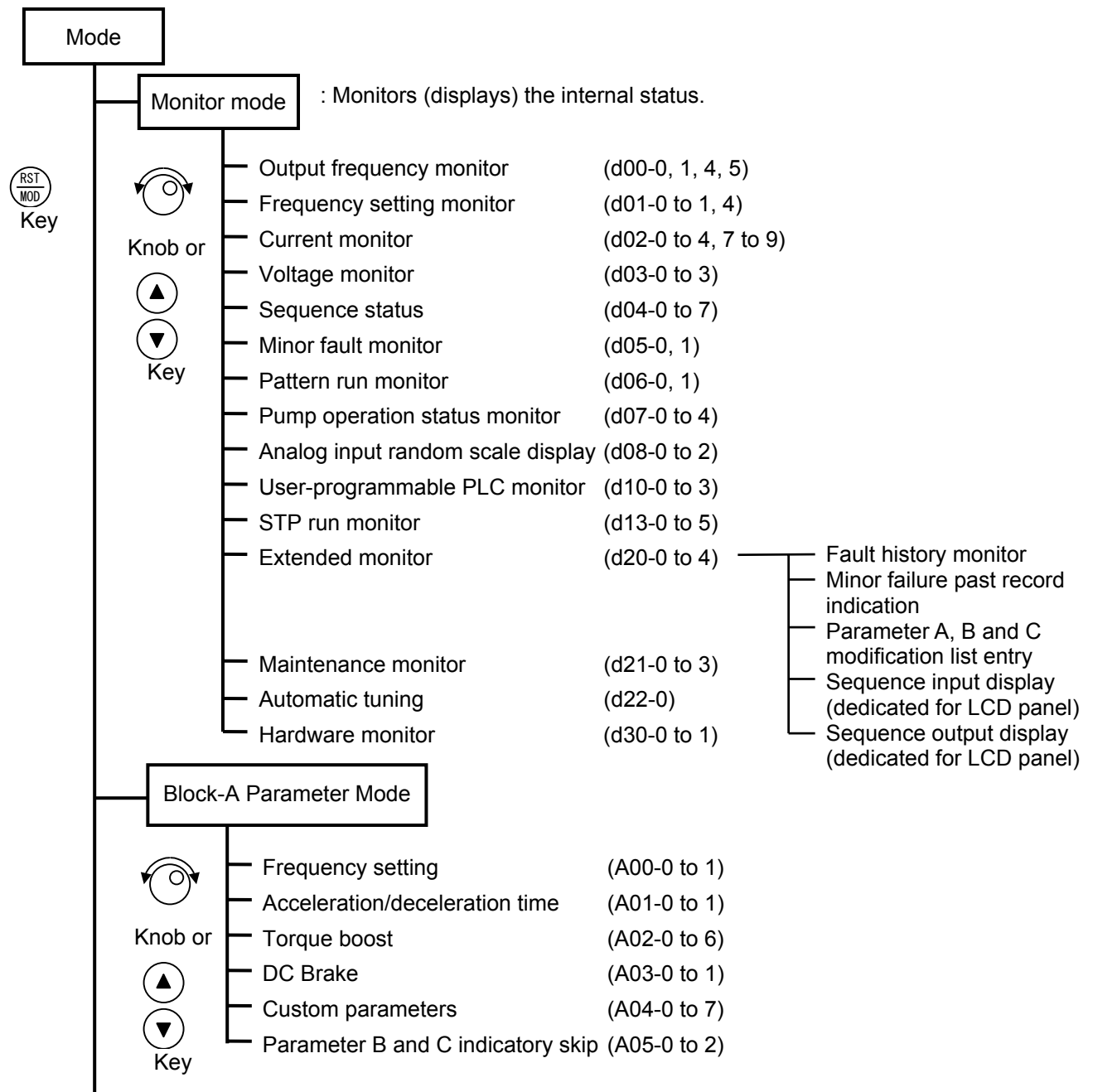

(Continued on next page)

Fig. 4-5-1 (1) Parameter configuration

4. Operation Panel

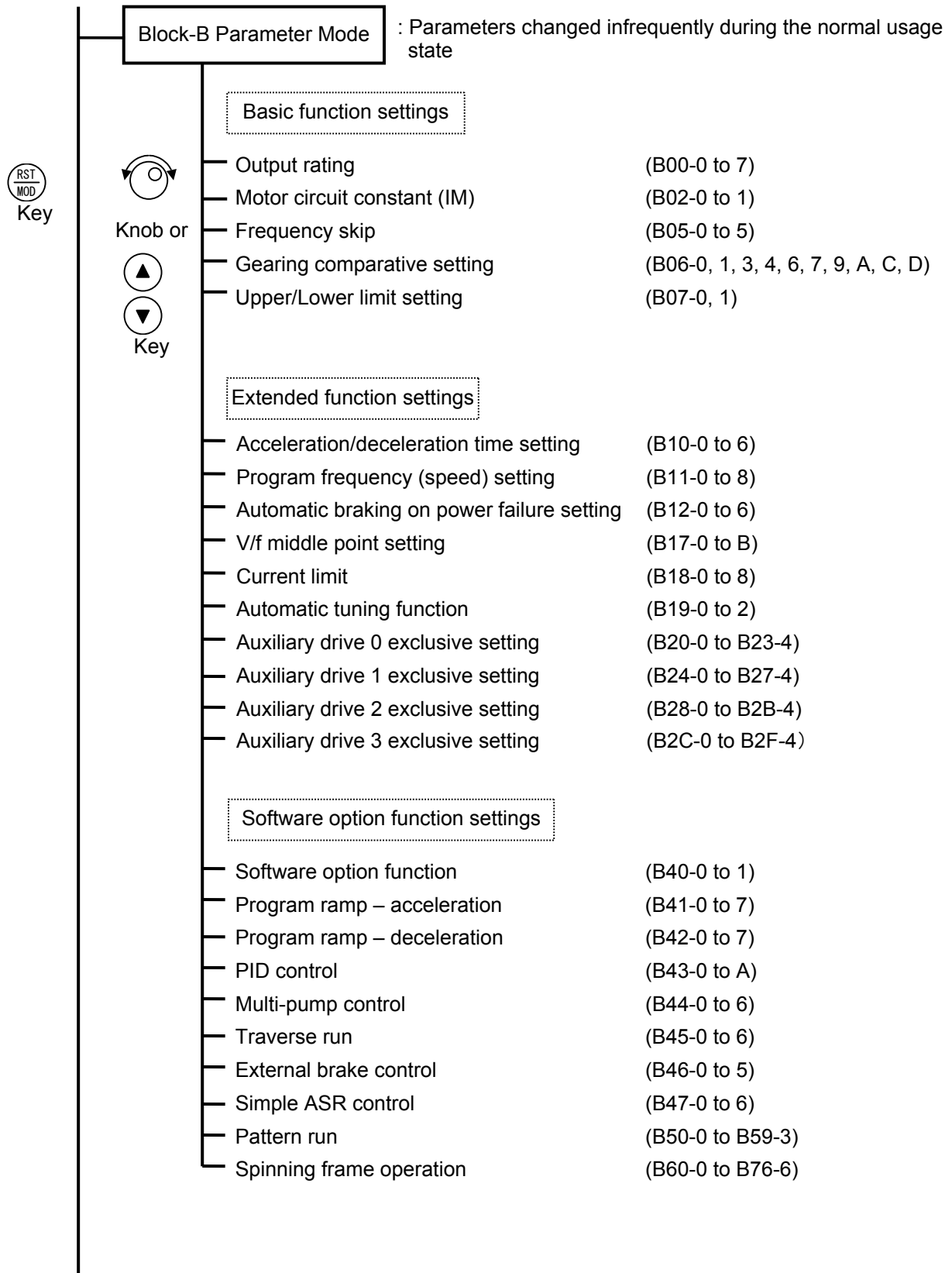

(Continued on next page)

Fig. 4-5-1 (2) Parameter configuration

4. Operation Panel

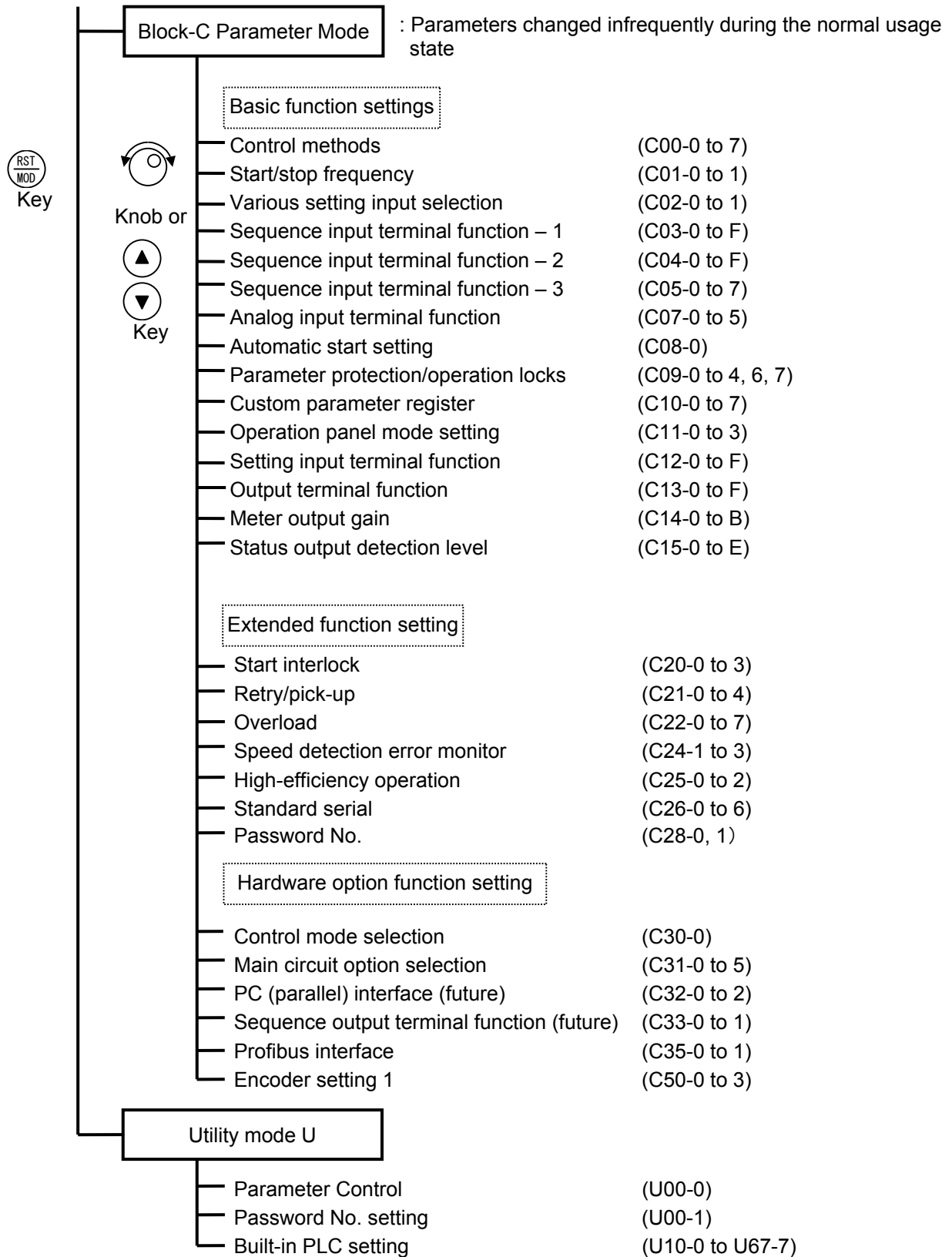

(Note) At the default setting, only the basic functions are displayed. The extended function, software option function, hardware option function parameters are skipped. Thus, to change these parameters, change parameter A05-0 to 2 (parameter B, C block skip setting), so that the target parameters are displayed.

Fig. 4-5-1 (3) Parameter configuration

**4-5-2 IM speed sensor-less vector control (C30-0 f0 = 2),
IM vector control with speed sensor (C30-0 f0 = 3)**

The configuration of the parameters is shown in Fig. 4-5-2.

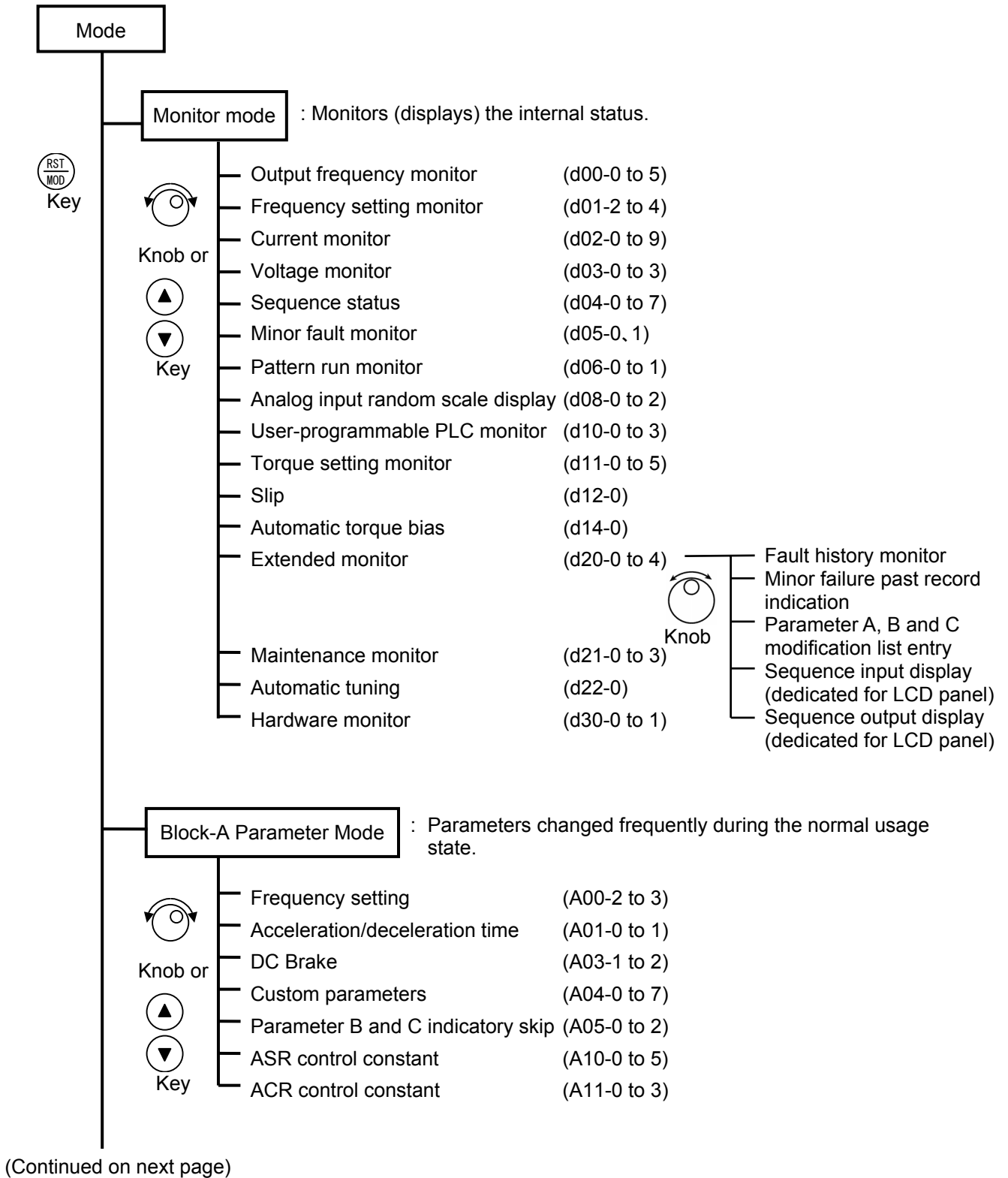

Fig. 4-5-2 (1) Parameter configuration

4. Operation Panel

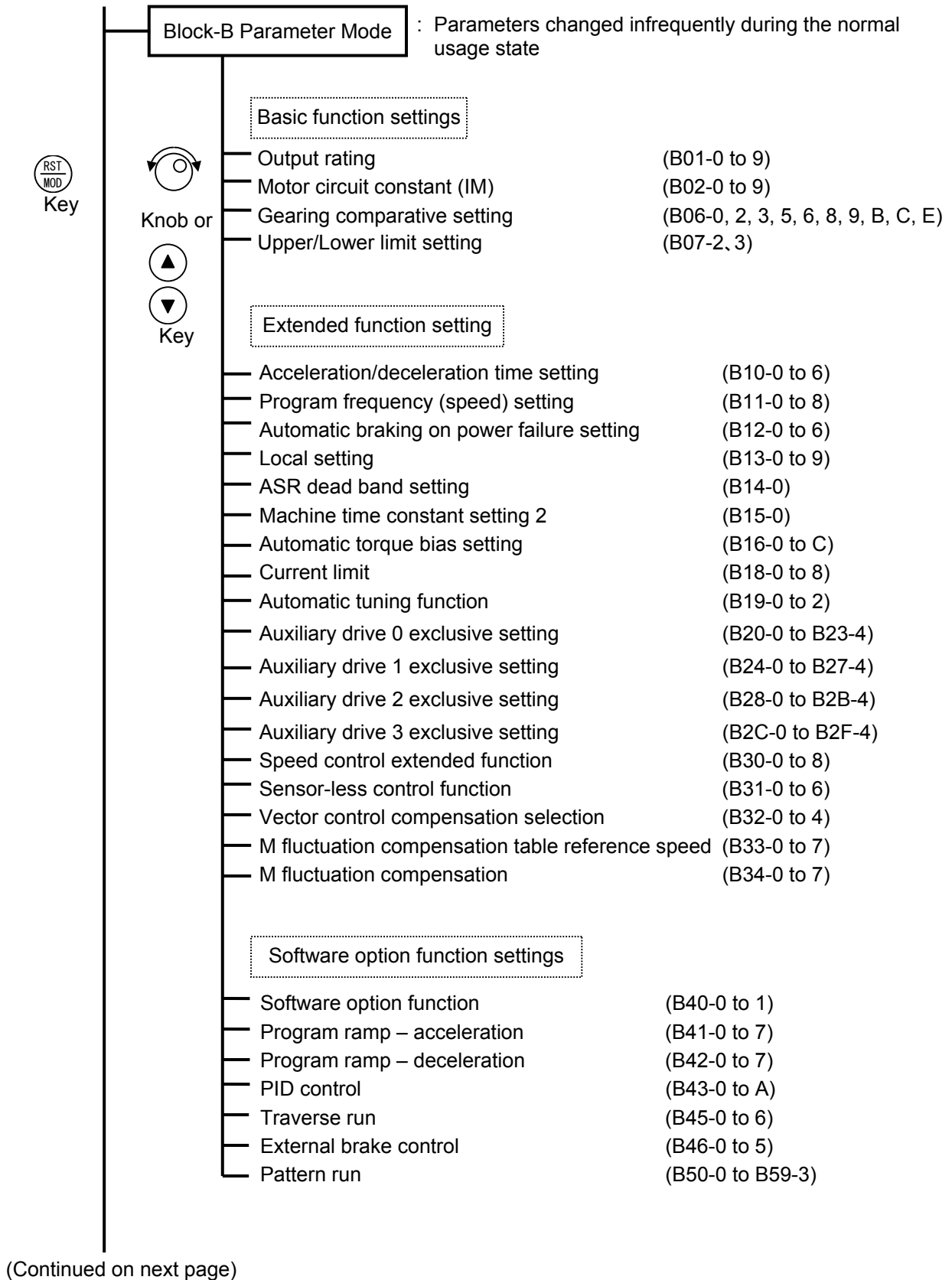
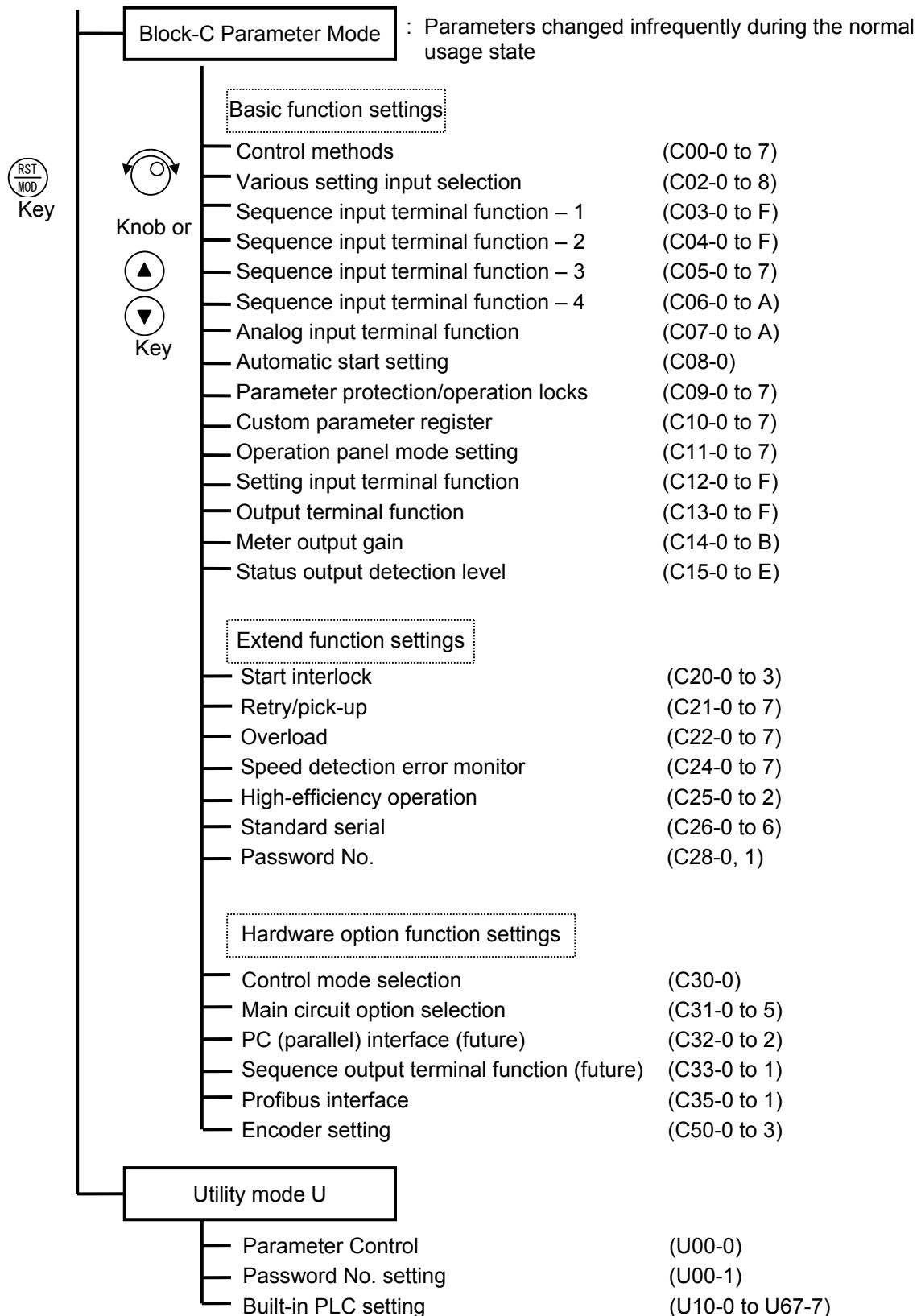

Fig. 4-5-2 (2) Parameter configuration

4. Operation Panel



(Note) At the default setting, only the basic functions are displayed. The extended function, software option function, hardware option function parameters are skipped. Thus, to change these parameters, change parameter A05-0 to 2 (parameter B, C block skip setting), so that the target parameters are displayed.

Fig. 4-5-2 (3) Parameter configuration

4-5-3 PM motor control mode with sensor (C30-0 f0 = 4)

The configuration of the parameters is shown in Fig. 4-5-3.

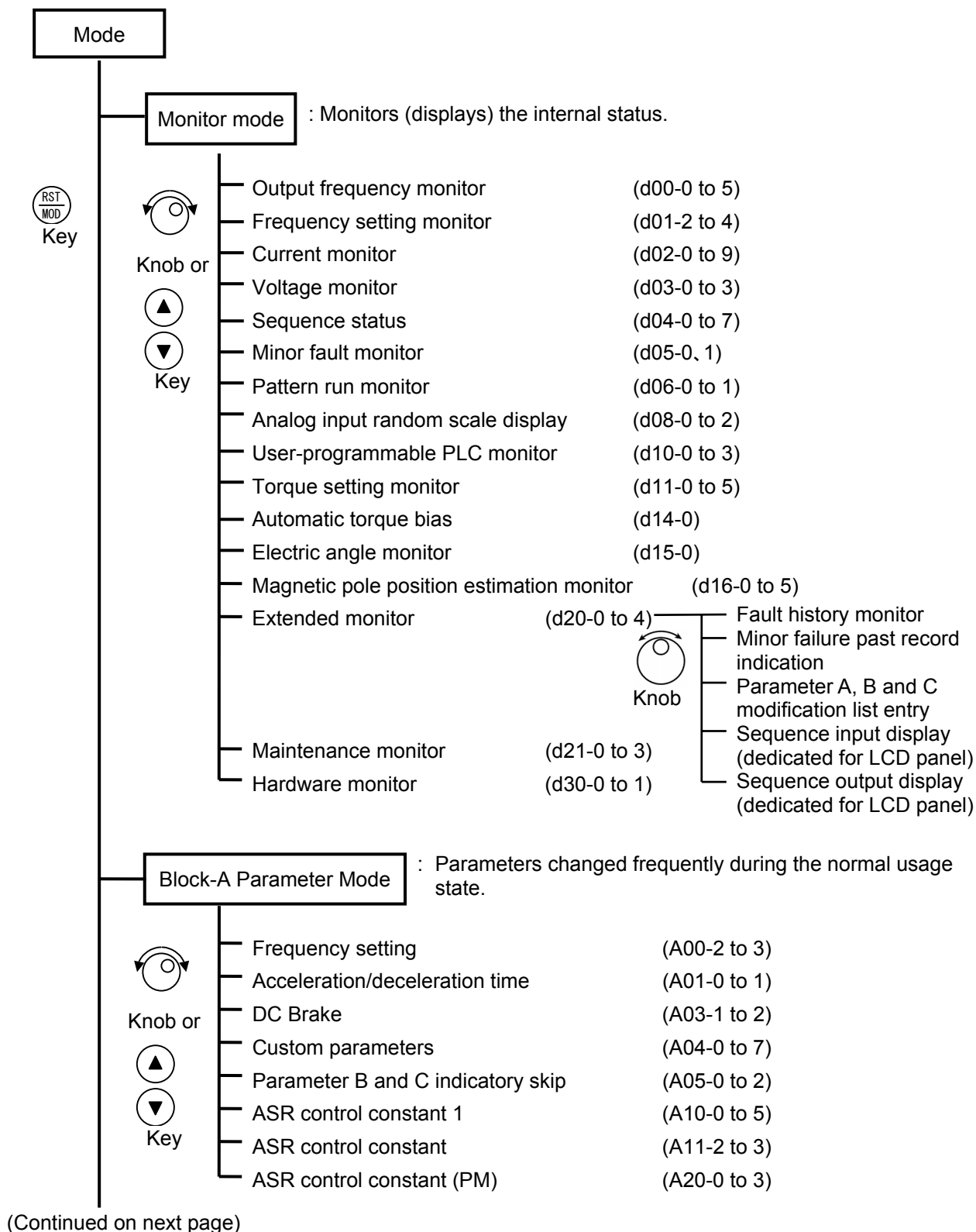

(Continued on next page)

Fig. 4-5-3 (1) Parameter configuration

4. Operation Panel

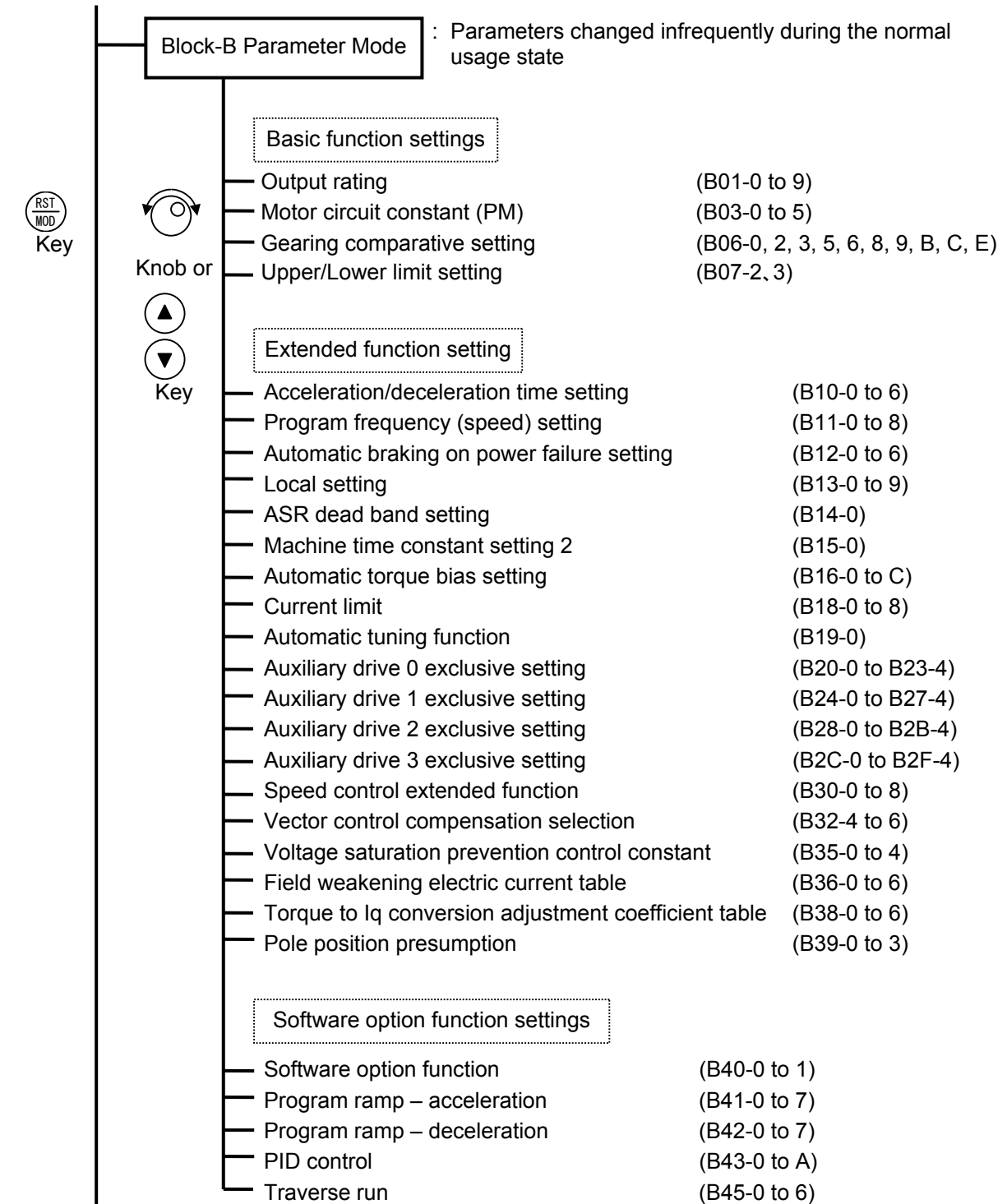

(Continued on next page)

Fig. 4-5-3 (2) Parameter configuration

4. Operation Panel

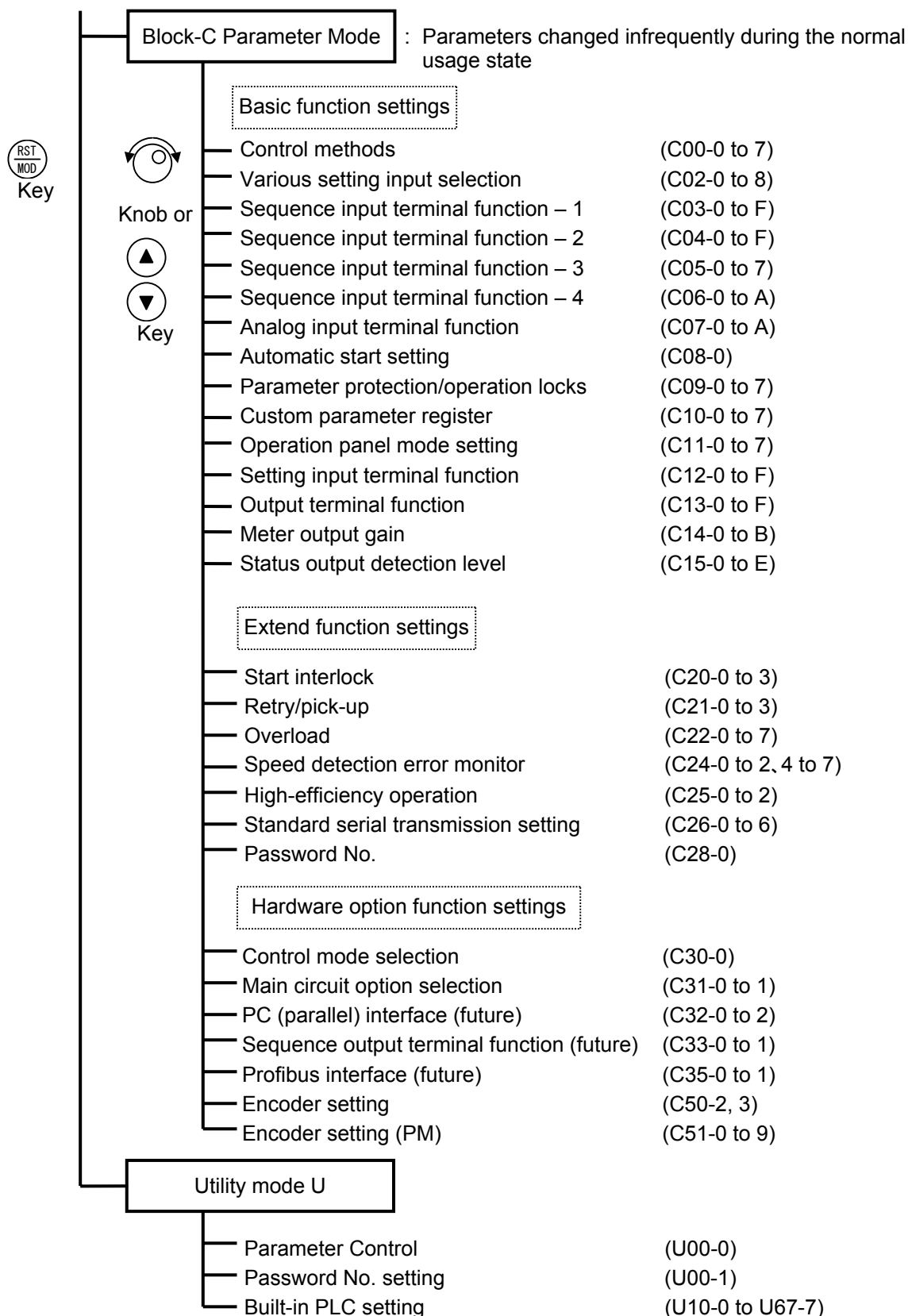

(Note) At the default setting, only the basic functions are displayed. The extended function, software option function, hardware option function parameters are skipped. Thus, to change these parameters, change parameter A05-0 to 2 (parameter B, C block skip setting), so that the target parameters are displayed.

Fig. 4-5-3 (3) Parameter configuration

Chapter 5 Control Input/Output

5-1 Input/output terminal function

The terminal block and input/output functions related to control are as shown in Tables 5-1.

Table 5-1 Terminal block functions (TB1, TB2)

	Symbol	Name	Features
Sequence input	PSI1 to PSI7	Programmable input	These commands can be arbitrarily led to the input signal circuit in the control PCB through sequence input selective setting (C03 to C06). The pulse train input uses input terminal PSI7.
	RY0, RY24	Sequence input common	These are common terminals for sequence input signals. There are two kinds for the change of the sink / source logic. RY24 and RY0 must not be shorted.
Analog input	AI1, 2	Programmable input	These are the analog input terminal in which the voltage input of the range of 0 to 10V and the current input of the range of 0 to 20mA are possible. These signals can be arbitrarily led to the input signal circuit in the control PCB through analog input selective setting (C07). AI1: Set C12-0 to 1 and DIP SW (DS1-2) to OFF for Voltage input. Set C12-0 to 2 and DIP SW (DS1-2) to ON for Current input. AI2 :Set C12-4 to 1 and DIP SW (DS1-3) to OFF for Voltage input. Set C12-4 to 2 and DIP SW (DS1-3) to ON for Current input.
	AI3		This is the analog input terminal in which the voltage input of the range of -10 to 10V is possible. This signal can be arbitrarily led to the input signal circuit in the control PCB through analog input selective setting (C07).
	COM	Analog input common	This is the common terminal for AI1, AI2 and AI3 signals.
Analog output	A01, A02	Programmable output	These are the analog output terminals for meter, and are switched to a voltage output and a current output. Arbitrary internal signals can be outputted by setup of an output terminal function (C13-0,C13-1). AO1: Set W3 to 1 and set C14-7 to 1 or 2 for Voltage output. Set W3 to 2 and set C14-7 to 3 for Current output. AO2: Set W4 to 1 and set C14-8 to 1 or 2 for Voltage output. Set W4 to 2 and set C14-8 to 3 for Current output.
	COM	Analog output common	This is the common terminal for the AO1 and AO2 signals.
	P10	AI1 or AI2 source	This is a terminal for supplying a power supply to an analog input VR. This terminal is connected to 15V power supply through 750-ohm resistance.
Sequence output	RA, RC	Programmable output (1a contact)	This is a relay contact output. Internal signals can be output with the C13-2 setting.
	FA, FB, FC	Programmable output (1c contact)	This is a relay contact output. Internal signals can be output with the C13-6 setting.
	PSO1 to PSO3	Programmable output (Open collector)	This is the open collector output. Internal signals can be output with the C13-3,4,5 setting.
	PSOE	Open collector output common	These are the common terminals for the PSO1, 2 and 3 signals.

5-2 Control input/output circuit

Examples of the control input/output circuit wiring are shown in table 5-2. The precautions must be observed during wiring.

Table 5-2 Control input/output circuit

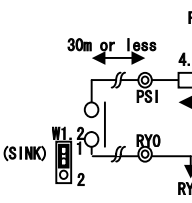
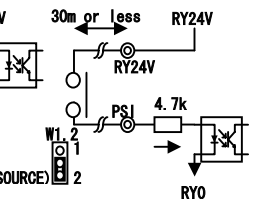
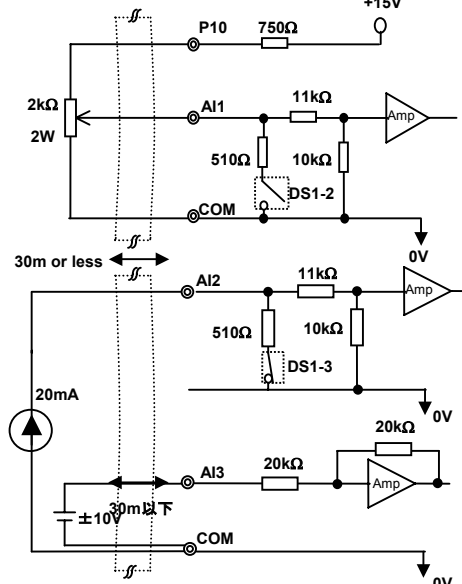
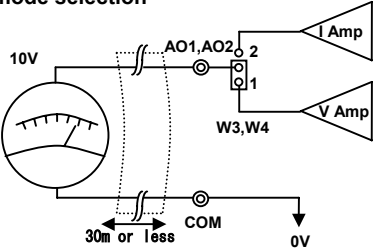
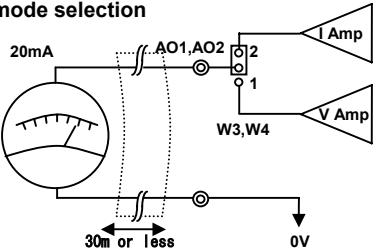
Function	Example of wirings	Precautions
Sequence input	<p>(a) Sink logic</p>  <p>(b) Source logic</p>  <p>(W1 is for PSI1 to PSI6, W2 is dedicated for PSI7.)</p>	<ol style="list-style-type: none"> 1. Wiring must not be longer than 30m. 2. The allowable leakage current is 0.5mA. 3. Use a minute current contact. 4. Do not connect to the analog input/output. 5. The sink/source logic can be changed with W1 and W2. (1: Sink 2: Source)
Analog input and P10 output		<ol style="list-style-type: none"> 1. Use 2kΩ/2W rating setter for the external variable resistor. (Only when using AI1 or AI2) 2. The AI1 and AI2 input mode is changed with the DIP switch (DS1) and parameter. Check the DIP switch setting before turning the power ON. The default setting is OFF (voltage mode). 3. The maximum input rating for AI1 and AI2 (voltage mode) is 0 to 10.5V. 4. The maximum input rating for AI1 and AI2 (current mode) is 0 to 20.5mA. 5. Use a shielded wire shorter than 30m for the wiring. 6. For shield connections, open the mate side, and connect VT240S side to COM. 7. Do not connect to the relay input.
Analog output	<p>Voltage mode selection</p>  <p>Current mode selection</p>  <p>(W3: for A01, W4: for A02)</p>	<ol style="list-style-type: none"> 1. Use a 10V full scale (impedance 10kΩ or more) meter (voltage mode selection). Note) The maximum output current is 1mA. 2. Use a 20mA full scale (impedance 500Ω or less) meter (current mode selection). 3. The mode is changed with the L bit (W3, W4) and parameter. (1: Voltage output, 2: Current output) 4. Use a shielded wire shorter than 30m for the wiring. 5. For shield connections, open the mate side, and connect VT240S side to COM.

5. Control Input/Output

Table 5-2 Control input/output circuit (continued)

Function	Example of wirings	Precautions																			
Sequence output (Relay output)		<p>1. Use within the rated range shown below. To comply with UL/CE, use at 30VAC/DC or less.</p> <table border="1" style="margin-left: auto; margin-right: auto;"> <thead> <tr> <th></th> <th style="text-align: center;">RUN</th> <th style="text-align: center;">FLT</th> </tr> </thead> <tbody> <tr> <td rowspan="3">Rated capacity (resistance load)</td> <td style="text-align: center;">250VAC 1A</td> <td style="text-align: center;">125VAC 0.4A</td> </tr> <tr> <td style="text-align: center;">30VDC 1A</td> <td style="text-align: center;">30VDC 1A</td> </tr> <tr> <td style="text-align: center;">1A</td> <td style="text-align: center;">1A</td> </tr> <tr> <td>Max. voltage</td> <td style="text-align: center;">250VAC</td> <td style="text-align: center;">250VAC 220VDC</td> </tr> <tr> <td>Max. current</td> <td style="text-align: center;">1A</td> <td style="text-align: center;">1A</td> </tr> <tr> <td rowspan="2">Switching capacity</td> <td style="text-align: center;">100VA 100W</td> <td style="text-align: center;">50VA 60W</td> </tr> </tbody> </table> <p>2. The wire must be shorter than 30m.</p>		RUN	FLT	Rated capacity (resistance load)	250VAC 1A	125VAC 0.4A	30VDC 1A	30VDC 1A	1A	1A	Max. voltage	250VAC	250VAC 220VDC	Max. current	1A	1A	Switching capacity	100VA 100W	50VA 60W
	RUN	FLT																			
Rated capacity (resistance load)	250VAC 1A	125VAC 0.4A																			
	30VDC 1A	30VDC 1A																			
	1A	1A																			
Max. voltage	250VAC	250VAC 220VDC																			
Max. current	1A	1A																			
Switching capacity	100VA 100W	50VA 60W																			
	Sequence output (Open collector output)		<p>1. To drive an L load, such as a coil, insert the fly wheel diode shown in the drawing.</p> <p>2. Keep the wiring length to 30m or less.</p> <p>3. Use within the following rating range. 30VDC, 50mA</p>																		

5-3 Programmable sequence input function (PSI)

The sequence signal input contacts include the three types of data sent from the basic PCB terminal block, the operation panel and the serial communication. The reset signals (RESET) are all input at logical OR from the input point, and the emergency stop signal (EMS) is input at the logical OR of the terminal block and serial transmission data.

For the other sequence signals, the input point can be determined with the input point changeover command (COP) or system parameter settings (J1, J2) from the operation panel.

The sequence input from the basic PCB terminal block is a 7-point programmable sequence input. For the programmable input, the function can be selected from Table 5-3 and randomly assigned. By connecting the relay interface option (V24-RY0), extension up to eleven channels is possible. The programmable input terminals are PSI1 to PSI7. When extended, the terminals are PSI1 to PSI11. The default settings are as shown below.

Default settings

Symbol	Setting
PSI1	Forward run
PSI2	Reset signal
PSI3	Emergency stop
PSI4	Reverse run
PSI5	Forward jogging
PSI6	Reverse jogging
PSI7	None

The programmable input signal functions are given in Table 5-3.

The general control block diagram of the IM speed sensor-less vector control and the IM vector control with speed sensor is shown in Fig.5-3.

5. Control Input/Output

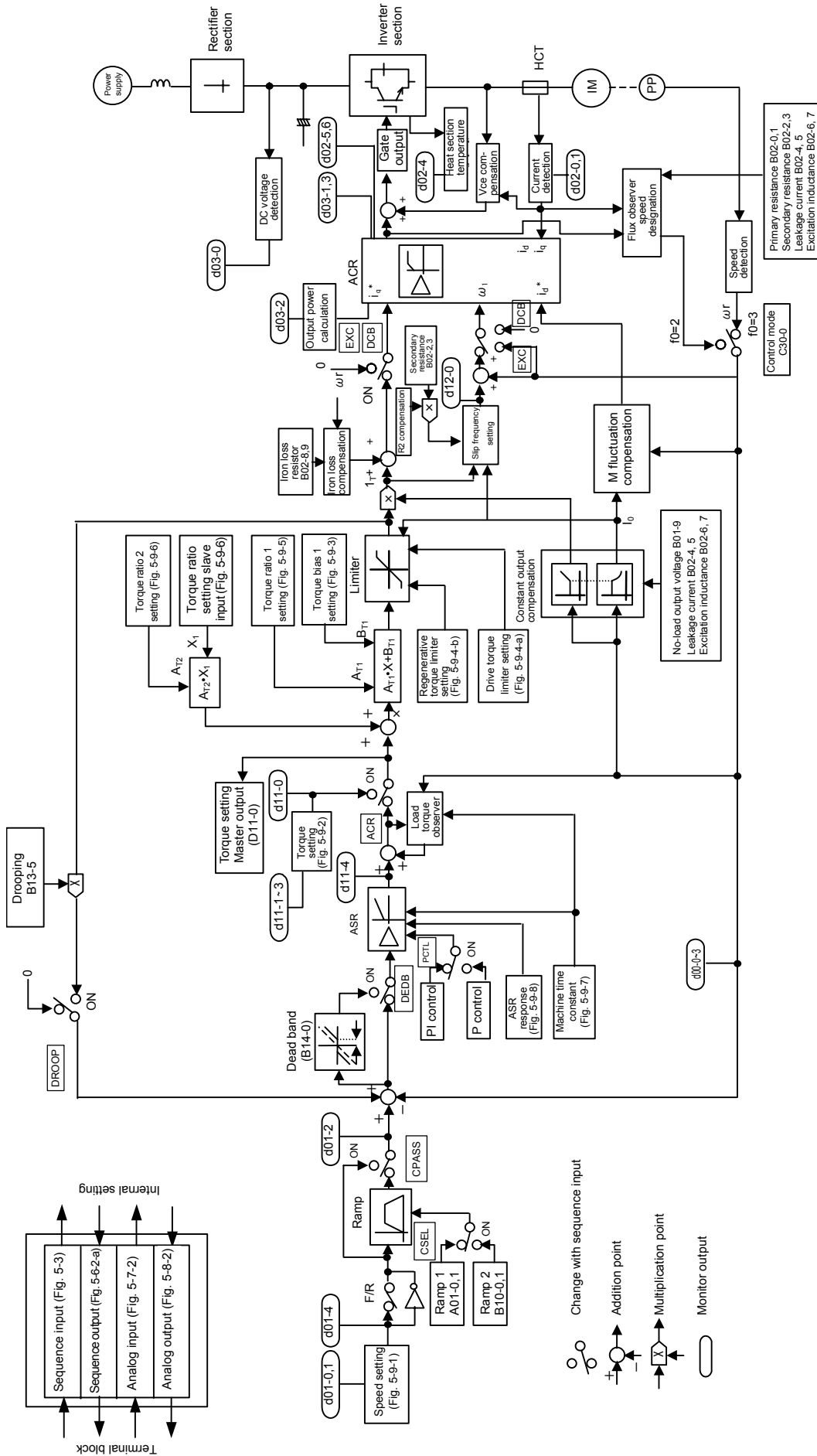

Fig. 5-3 Block diagram for IM vector control

5. Control Input/Output

Table 5-3 Programmable sequence input functions (1)

Connection of PSI1 to PSI11 is possible. Note that PSI8 to PSI11 are options.
The connection is done with data Nos.: C03 to C06

Symbol	Name	Function								
F RUN	Forward run	This is the forward run command for the remote operation mode (when LCL LED is not ON). The operation command or self-hold mode can also be selected. (C00-0)								
EMS	Reverse run	This stops all run commands when stopped. If turn ON during operation, the operation stops. The operation can be stopped with ramp deceleration stop or coast to stop. This signal can also be output as a fault (FLT). (C00-4)								
R RUN	Reverse run	This is a command for reverse run. A command of reverse run mode (C00-0=2) is available in the run/reverse mode.								
F JOG	Forward jogging	These are jogging commands. If this signal is ON while RUN is OFF, operation then conforms to the setting of jogging (A00-1 or 3) made within the control circuit. For stoppage, either ramp down stop or coast-stop is available. (C00-2)								
R JOG	Reverse jogging									
HOLD	Hold	This is a stop signal generated when the setting is to be the self-hold mode (C00-0=3) during the operating mode. The VT230SE stops with this signal turned off. Input of F RUN or R RUN can be held with this signal turned on.								
BRAKE	DC brake	DC brake can be operated with this signal. In the case of PM motor control, DC excitation takes place. Shaft torsion will occur according to the load torque.								
RESET	Fault reset	This resets the fault state. The fault output (FLT LED ON, FAULT relay) can be turned OFF and operation resumed with this signal.								
COP	Serial transmission selection	<p>The sequence commands from serial transmission are validated. By selecting the control changeover method (C00-6), the input point of the auxiliary operation sequence during COP ON can be selected.</p> <table border="1" style="margin-left: auto; margin-right: auto;"> <thead> <tr> <th>COP</th> <th>C00-6</th> <th>Input point</th> </tr> </thead> <tbody> <tr> <td rowspan="2">ON</td> <td>1</td> <td>Terminal block input</td> </tr> <tr> <td>2</td> <td>Serial transmission input</td> </tr> </tbody> </table> <p>For resetting and emergency stop, the terminal block and serial transmission are both valid regardless of the C00-6 setting.</p>	COP	C00-6	Input point	ON	1	Terminal block input	2	Serial transmission input
COP	C00-6	Input point								
ON	1	Terminal block input								
	2	Serial transmission input								
CSEL	Ramp selection	Accel./decel. ramp performance is switched over. Accel./decel. time 2 (B10-0, 1) is available with ON, and accel./decel. time 1 (A01-0, 1 Note that B21-2,3 is used when the auxiliary drive is selected) is available with OFF.								
I PASS	Ratio interlock bypass	Ratio interlock operation is bypassed.								
CPASS	Ramp bypass	The ramp function is bypassed.								
PIDEN	PID control selection	The PID control is validated.								

5. Control Input/Output

Table 5-3 Programmable sequence input functions (2)

Symbol	Name	Function															
AFS1	Speed setting 1 selection	The frequency (speed) setting is carried out with the input selected with C07-0.															
AFS2	Speed setting 2 selection	The frequency (speed) setting is carried out with the input selected with C07-1.															
AFS3	Speed setting 3 selection	The frequency (speed) setting is carried out with the input selected with C07-2.															
PROG	Program function enable	Used for multiple setting. Selection of 8 steps (PROG0~PROG7) is made with S0~S3, SE.															
CFS	Serial communication setting select	Selects settings from the serial or parallel transmission option.															
S0 to S3 SE	Program setting selection	When PROG is ON, the program frequency (speed) 0~7 are selected (B11-0~7). The BCD/Direct input mode can be selected with B11-8.															
FUP	Frequency (speed) increase	The currently selected direct frequency (speed) setting (A00-0) or program frequency (speed) setting 0 to 7 (B11-0~7) is increased or decreased.															
FDW	Frequency (speed) decrease	When the ON state continues, the frequency is incremented/decremented with the currently valid ramp rate.															
BUP	Ratio interlock bias increase	When IVLM is ON and the BUP, BDW ON state continues, the sequential ratio bias will increase/decrease at the currently valid ramp rate.															
BDW	Ratio interlock bias decrease																
IVLM	Ratio interlock bias increase/decrease selection	When IVLM turns OFF, the bias increase/decrease value will be cleared to zero. The BUP, BDW operation will be invalidated.															
AUXDV	Auxiliary drive selection	The auxiliary drive setting is validated with this signal. This operation is valid during the inverter stopping.															
PICK	Pick-up	While this signal is ON, pick-up operation is effected as soon as F RUN or R RUN is ON.															
MBRK_ans	External brake answer	Inputs an answer in response to the external brake command.															
PRST	STP reset	Inputs the pattern operation reset signal when performing spinning frame operation.															
S5 to S7	Digital torque bias 0 to 4	Selects a digital torque bias value (B16-0~5) by inputting.															
AUXSW0	Auxiliary drive No. selection L	<table border="1" style="width: 100%; border-collapse: collapse;"> <thead> <tr> <th style="text-align: center;">Auxiliary drive No.</th> <th style="text-align: center;">AUXSW1</th> <th style="text-align: center;">AUXSW0</th> </tr> </thead> <tbody> <tr> <td style="text-align: center;">Auxiliary drive 0</td> <td style="text-align: center;">0</td> <td style="text-align: center;">0</td> </tr> <tr> <td style="text-align: center;">Auxiliary drive 1</td> <td style="text-align: center;">0</td> <td style="text-align: center;">1</td> </tr> <tr> <td style="text-align: center;">Auxiliary drive 2</td> <td style="text-align: center;">1</td> <td style="text-align: center;">0</td> </tr> <tr> <td style="text-align: center;">Auxiliary drive 3</td> <td style="text-align: center;">1</td> <td style="text-align: center;">1</td> </tr> </tbody> </table>	Auxiliary drive No.	AUXSW1	AUXSW0	Auxiliary drive 0	0	0	Auxiliary drive 1	0	1	Auxiliary drive 2	1	0	Auxiliary drive 3	1	1
Auxiliary drive No.	AUXSW1		AUXSW0														
Auxiliary drive 0	0		0														
Auxiliary drive 1	0		1														
Auxiliary drive 2	1	0															
Auxiliary drive 3	1	1															
AUXSW1	Auxiliary drive No. selection H																
PLS_IN	Pulse train input selection	This validates the pulse train input.															
OCLLV1	OCL level setting 1	The overcurrent limit level 2 (B18-7) is validated during main drive operation.															
OCLLV2	OCL level setting 2	The overcurrent limit level 3 (B18-8) is validated during main drive operation.															

5. Control Input/Output

Table 5-3 Programmable sequence input functions (3)

Symbol	Name	Function
EXC	Pre-excitation	Pre-excitation operation takes place. Pre-excitation operation refers to establishing only the flux in the motor without generating torque. If torque is required immediately from the start of operation, use pre-excitation operation beforehand to establish the flux in the motor.
ACR	ACR	ACR operation is selected.
PCTL	P Control	ASR control is changed from the PI control to the P control.
LIM1	Drive torque limiter changeover	The drive torque limiter reduction setting by the analog input or serial transmission is validated.
LIM2	Regenerative torque limiter changeover	The regenerative torque limiter reduction setting by the analog input or serial transmission is validated.
MCH	Machine time constant changeover	During ASR operation, ASR gain is changed over. Machine time constant 2 (B15-0) is available with ON, and machine time constant 1 (A10-1) is available with OFF.
RF0	0 setting	The speed setting is changed to 0min^{-1} .
DROOP	Drooping changeover	Drooping function is validated. (B13-5)
DEDB	Dead band setting	The dead band setting of ASR is validated. (B14-0)
TRQB1	Torque bias setting 1	The torque bias input 1 is valid.
TRQB2	Torque bias setting 2	The torque bias input 2 is valid.

5. Control Input/Output

5-4 Programmable sequence output function (PSO)

As a standard, the sequence outputs include five channels (1c contact output: one channel, 1a contact output: one channel, open collector output: three channels). The signals shown in Table 5-4 can be randomly output from the five channels. By connecting the relay or PC interface option (V24-RY0, V24-PI0), extension up to seven channels is possible. The programmable output terminals are FA-FB-FC, RA-RC, PSO1, PSO2 and PSO3 as standard. When extended, the terminals are FA-FB-FC, RA-RC and PSO1~PSO7. The default values are as shown on the right.

The functions of the programmable output signals are given in Table 5-4.

Default values

Terminal symbol	Setting
FA-FB-FC	Fault
RA-RC	Run
PSO1-PSOE	Ready (1)
PSO2-PSOE	Current detection
PSO3-PSOE	Frequency (speed) attainment

Table 5-4 Programmable sequence output functions

Symbol	Name	Function
RUN	Run	This turns ON during running, jogging or DC braking. Turning ON or OFF during pre-excitation can be selected. At C00-7=1, run output is ON during pre-excitation . At C00-7=2, run output is OFF during pre-excitation .
FLT	Fault	This turns ON during a fault.
MC	Charge completed	This turns ON when the DC main circuit voltage reaches a voltage higher than the MC ON level.
RDY1	Ready (1)	This turns ON when there is no fault, EMS is not activated, pre-charging is complete and the encoder signal is detected (only in PM motor control with sensor mode).
RDY2	Ready (2)	This turns ON when there is no fault, pre-charging is complete and the encoder signal is detected (only in PM motor control with sensor mode).
LCL	Local	This turns ON when the operation mode is local (operation from the operation panel).
REV	Reverse run	V/f: This turns ON while the output frequency is reverse running. VEC, PM: This turns ON while the motor is reverse running.
IDET	Current detection	This turns ON when the output current reaches the detection level (C15-1) or higher.
ATN	Frequency (speed) attainment	This turns ON when the output frequency (speed) reaches the set frequency (speed). The detection reach width is set with C15-0.
SPD1	Frequency(speed) detection (1)	This turns ON when the output frequency (speed) absolute value reaches a frequency(speed) higher than the speed set with the detection level (C15-2).
SPD2	Frequency(speed) detection (2)	This turns ON when the output frequency (speed) absolute value reaches a frequency(speed) higher than the speed set with the detection level (C15-3).
COP	Transmission selection	This turns ON when serial transmission operation is selected.
EC0~EC3	Specific fault output	This turns ON when the fault set up by C15-6,7,8,9 occurs.
ACC	Acceleration	This turns ON during acceleration.
DCC	Deceleration	This turns ON during deceleration.
AUXDV	Auxiliary drive selection	This turns ON when the auxiliary drive parameter setting is validated by the sequence input AUXDV.
ALM	Minor fault	This turns ON during a minor fault.
FAN	Fan control	This turns ON during running, jogging, pre-excitation and DC braking. A three minute off delay is provided, so even if the above operations turn OFF, this control will not turn OFF for three minutes. This is used for external fan control.
ASW	Automatic start wait	When C08-0 is selected and the automatic start function is used, this will turn ON while waiting for automatic start.
ZSP	Zero speed	This turns ON when the output frequency (speed) absolute value is below the level set with zero speed (C15-4).
LL MT	PID lower limit output	This turns ON when the feedback value exceeds the lower limit value (<B43-4) during PID control.
ULMT	PID upper limit output	This turns ON when the feedback exceeds the upper limit value (>B43-3) during PID control.
Doff-End	Doff-End alarm output	This turns ON only at the point going back the set time (B60-5) from the moment auto stoppage is engaged after completing the final step when performing spinning frame operation.
MBRK	External brake output	Outputs an external brake command.
DVER	Speed deviation error	This turns ON during a speed deviation error.
BPF	Stoppage deceleration output	This turns ON when the DC voltage is the set value (B12-1) or under during automatic braking on power failure function.
RDELAY	Run delay answer	This signal delays(C15-5) the turning OFF of the sequence output RUN.
MPO1~8	Multi-pump output	Output signal for multi-pump control
PLC1~8	Built-in PLC output	Sequence output signal of Built-in PLC

(Note) "ON" indicates that the contact is closed when + is set, and the contact is open when - is set.

5-5 Sequence input logic

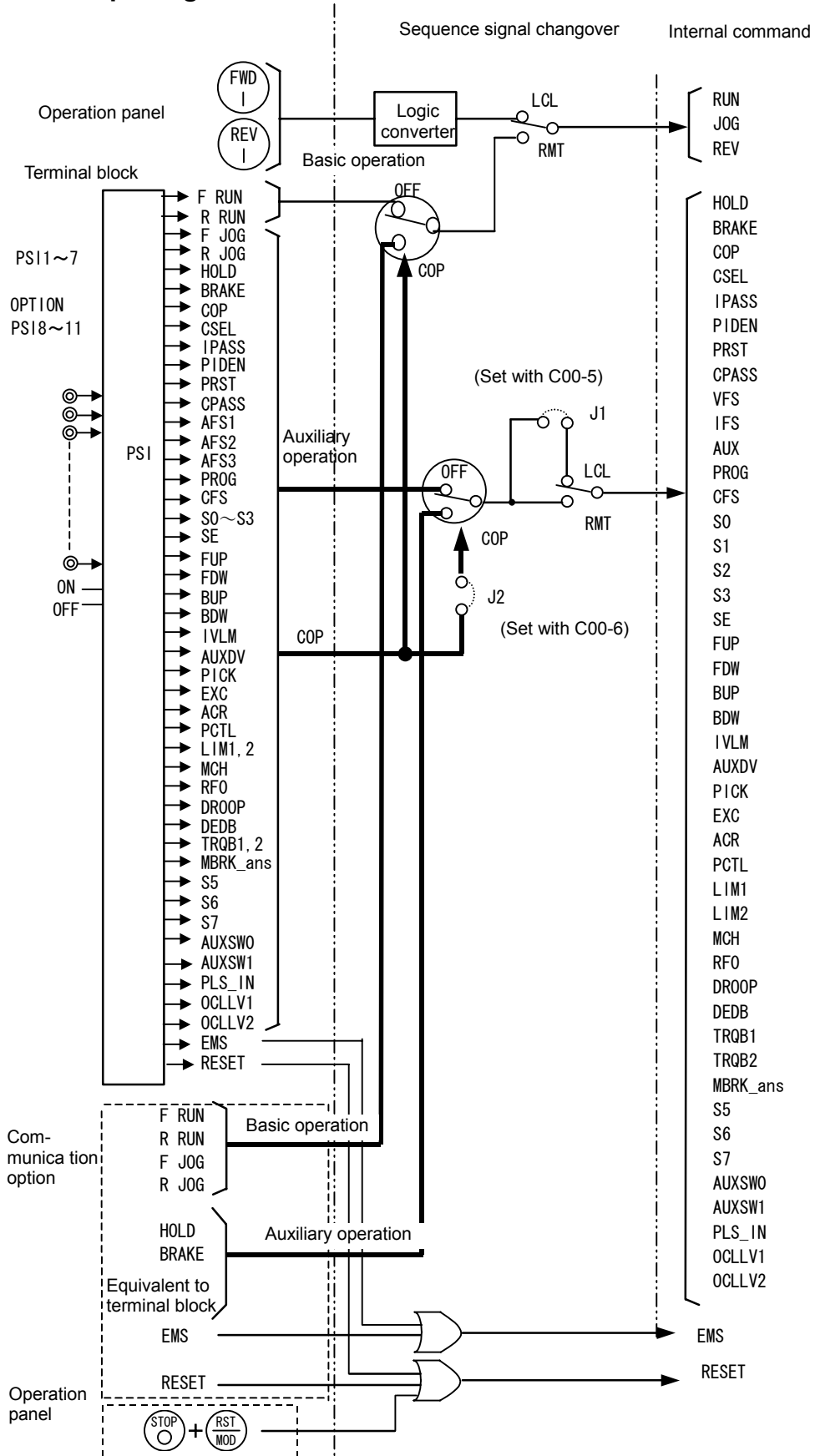

Fig. 5-5 Sequence input logic

5-6 Changing of terminal functions

The programmable input terminals (PSI1 to PSI11) can be connected to arbitrarily internal commands. The internal state can be connected to the programmable output terminal (FA-FB-FC, RA-RC and PSO1 to PSO5) to lead in the ON/OFF signals.

5-6-1 Sequence input terminal assignment and monitoring

The parameters can be assigned to the terminal block as shown in Fig. 5-6-1-a according to the parameter Nos. C03 to C06. Each internal signal can be fixed to ON (set value to 16) or OFF (set value to 0). Fig. 5-6-1-b shows the case when the ON state of each internal signal is shown on the D04 monitor. This monitoring is performed with D04-0 to 3. F RUN, R RUN, F JOG and R JOG are displayed with a combination of RUN, REV and JOG converted into an internal command.

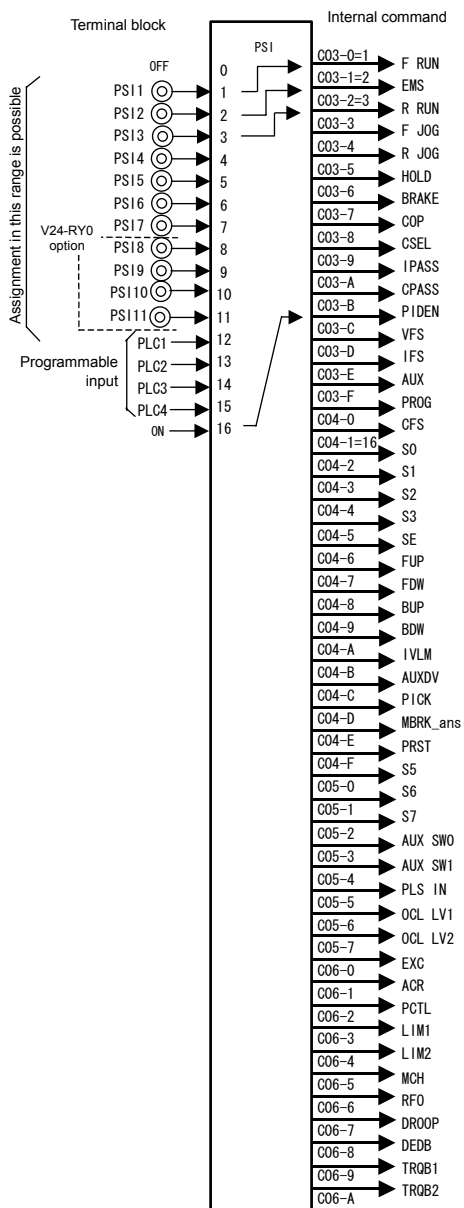

Fig. 5-6-1-a Assignment of sequence input

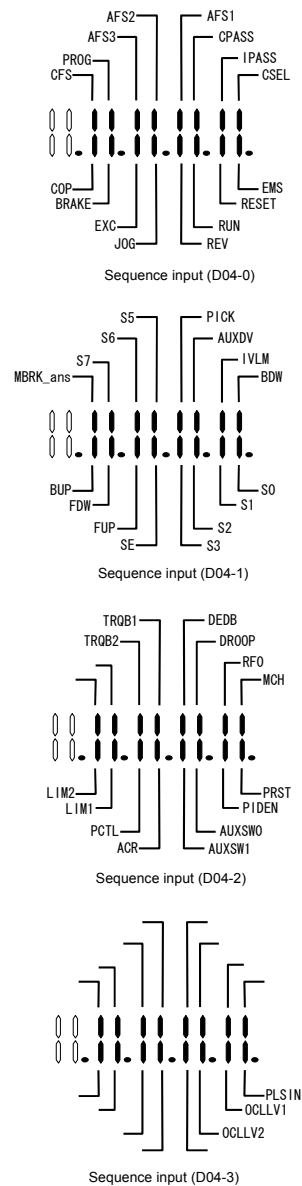

Fig. 5-6-1-b Sequence input monitor

5-6-2 Sequence output terminal assignment and monitoring

The ON/OFF of the internal signals can be output to the FA-FB-FC, RA-RC and PSO1 to 7 terminals as shown in Fig. 5-6-2-a with the parameter Nos. C13-2 to 6 and C33-0 to 3. The ON/OFF of each signal can be monitored as shown in Fig. 5-6-2-b. This monitoring is executed with D04-4, 5, 6, 7.

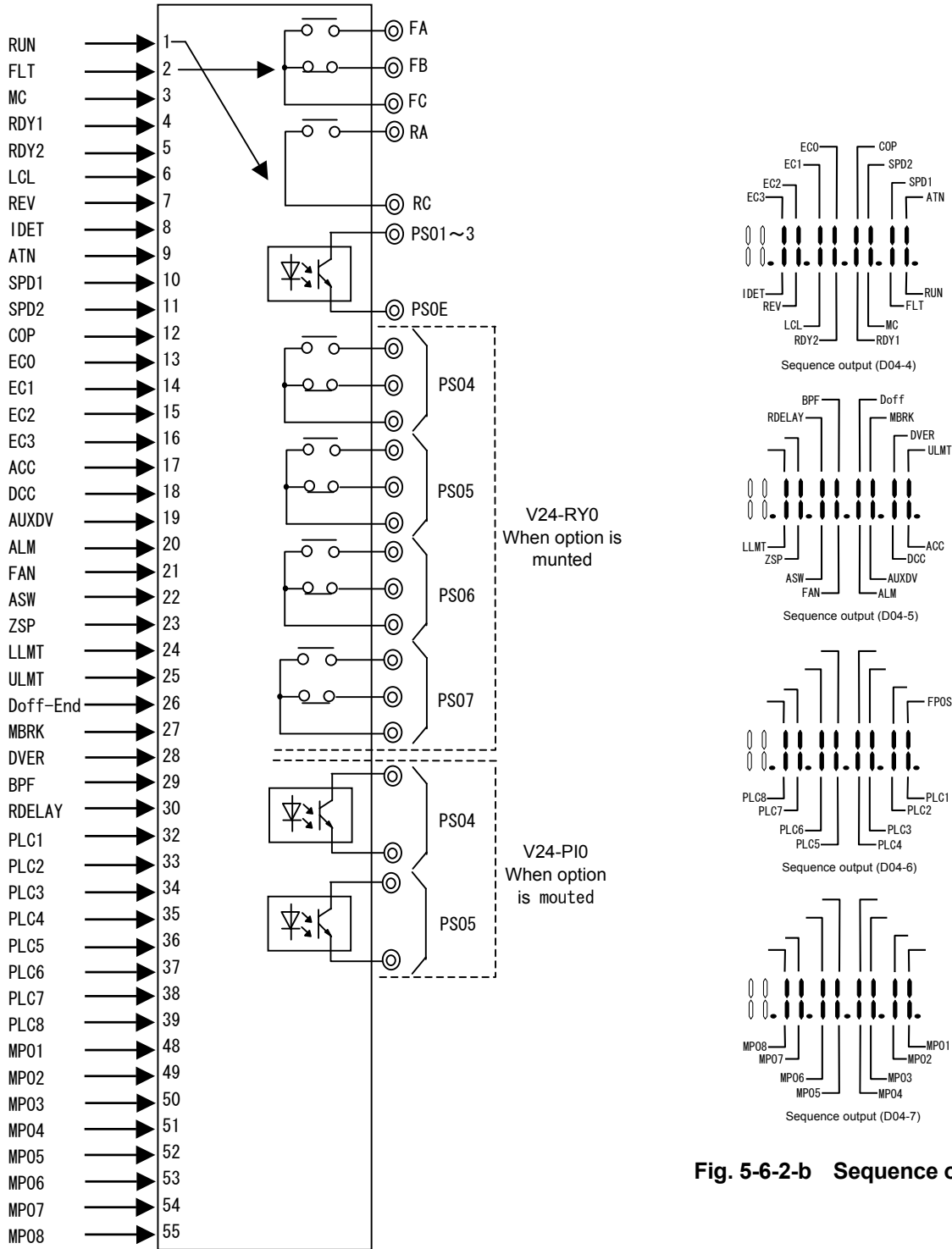

Fig. 5-6-2-b Sequence output

Fig. 5-6-2-a Assignment of sequence output

Note) When positive setting data is selected, RA is closed at ON and RA is opened at OFF. When negative setting data is selected, the logic is reversed.

5-7 Programmable input function (PI)

5-7-1 Types of analog inputs

As a standard, there are three channels for the analog input. Each analog input can be connected to the internal setting signals shown in Table 5-7-1 by using the programmable input function.

Table 5-7-1 Types of internal setting signals assigned to analog input

Signal name	Setting range (Note1)(Note3)		Function	
	AI1, 2			AI3
	Voltage mode	Current mode		
	0~10V 0~5V 1~5V	4~20mA 0~20mA	-10~10V -5~5V 1~5V	
Speed setting 1 Speed setting 2 Speed setting 3	0~100%	-100~100%	This is the speed setting. The + polarity is the forward run setting, and the - polarity is the reverse run setting. If the analog input is selected with the speed setting, the speed setting can be changed between 1, 2 and 3 with the sequence input (AFS1,AFS2,AFS3).	
		0~100%		
Ratio interlock bias setting	0~100%	-100~100%	This is the bias setting for the sequential ratio operation.	
		0~100%		
Traverse center frequency setting	0~100%	(0~10V) 0~5V	This is the center frequency setting for traverse operation.	
		0~100% (Note 2) 0~100%		
PID feedback	0~100%	(0~10V) 0~5V	This can be used as the feedback input to configure a feedback loop. Do not use the programmable analog output (AO1,AO2) as the PID feedback signal.	
		0~100% (Note 2) 0~100%		
Torque setting	0~300%	-300~300%	This is the torque setting for ACR operation. The + polarity is the forward run direction torque, and the - polarity is the reverse run direction torque. The torque setting can be limited by using the torque limiter (A11-2, 3).	
		0~300%		
Drive torque limiter reduction setting	0~100%	(0~10V) 0~5V	The drive torque limit (A10-3 or A11-2) is multiplied using 0V to +10V as 0 to 100%, and the limit value is reduced. This function is valid when the drive limiter changeover (LIM1) is turned ON with the sequence input.	
		0~100% (Note 2) 0~100%		
Regenerative torque limiter reduction setting	0~100%	(0~10V) 0~5V	The regenerative torque limit (A10-4 or A11-3) is multiplied using 0V to +10V as 0 to 100%, and the limit value is reduced. This function is valid when the regenerative limiter changeover (LIM2) is turned ON with the sequence input.	
		0~100% (Note 2) 0~100%		
Torque bias 1 setting	0~300%	-300~300% 0~300%	This is added to ASR output during ASR operation, or to the torque setting during ACR operation. This function is valid when the torque bias 1 (TRQB1) is turned ON with the sequence function.	
		0~300%		
Analog torque bias setting	0~100%	-100~100%	This is the torque bias setting when the auto torque bias selection (B16-0) is analog.	
		0~100%		

5. Control Input/Output

(Note 1) Select each analog input mode with C12-0 to A.

(Note 2) AI3 : The setting is limited to 0% during the -10 to 0V and -5 to 0V input.

(Note 3) Setting range/Resolution: AI1, 2 (Voltage mode): 0 to 10V/12 bit,
 AI1, 2 (Current mode): 0 to 20mA/12 bit,
 AI3 : -10V to 10V/12 bit

The resolution is reduced according to setting range.

Example) AI1 (Current mode) : 0 to 5V/11 bit

Example 5-1) Set as shown below for voltage input mode 0 to 10V.

AI1 : C12-0=1 (voltage input mode selection) C12-1=1 (0 to 10V selection) DIP switch DS1-2 OFF

AI2 : C12-4=1 (voltage input mode selection) C12-1=1 (0 to 10V selection) DIP switch DS1-3 OFF

Example 5-2) Set as shown below for current input mode 4 to 20mA

AI1: C12-0=2 (Current input mode selection), C12-2=1 (4 to 20mA selection), DIP switch DS1-2 ON

AI2: C12-4=2 (Current input mode selection), C12-2=1 (4 to 20mA selection), DIP switch DS1-3 ON

5-7-2 Setting the analog input

The analog input can be assigned to the random internal setting signals given in Table 5-7-1 by setting parameter C07-0 to A as shown in Fig. 5-7-2.

The setting is completed by setting the data corresponding to the analog input (AI1, AI2, AI3) in C07-0 to A. Set "0" for the internal setting signals that are not to be used.

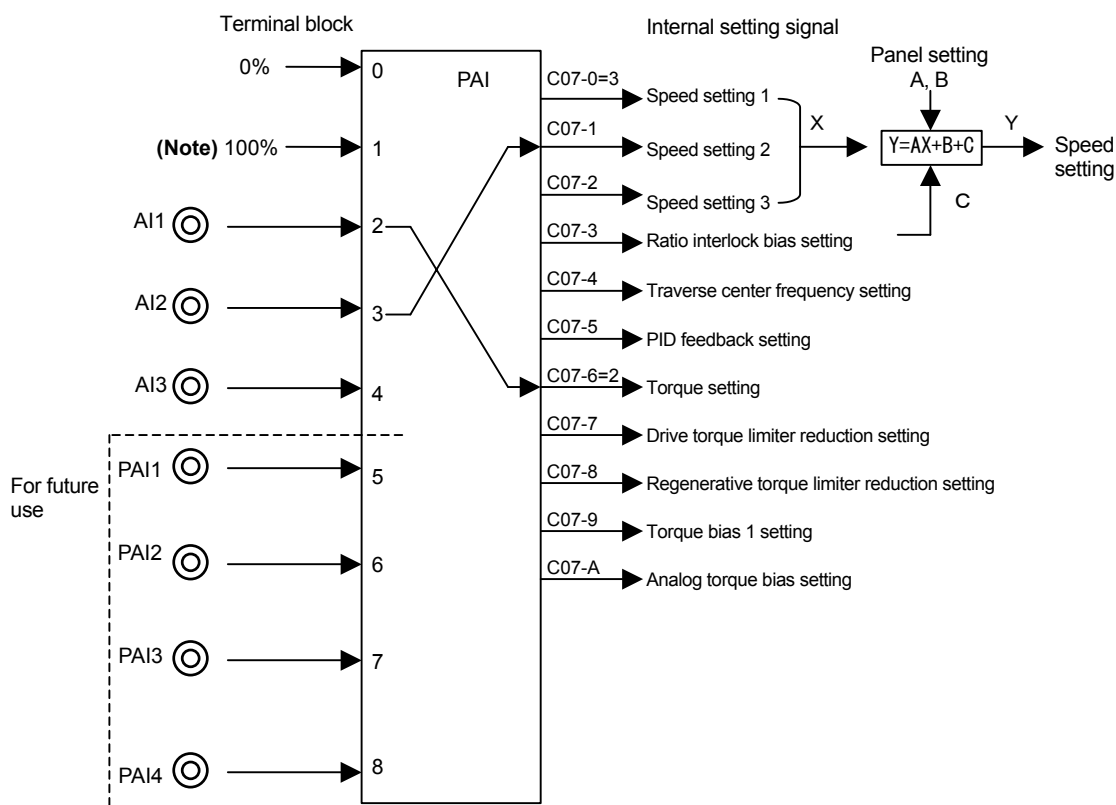

(Note) The torque setting is 300% when C07-6 is 1.

Fig. 5-7-2 Analog input assignment

The sequential ratio operation can be carried out in respect to speed settings 1 to 3. (Refer to 6-6, B06.)

5-7-3 Pulse train input

The pulse train input is one channel and uses input terminal PSI7. When using the pulse train input function, PSI7 cannot be used as the sequence input.

Set the control PCB as shown below for using the pulse train input function.
 Set the L bit W2 to source logic (2 side) before turning ON the power.
 Connect the pulse train signal to PSI7 and the common to RY0.

Start the pulse train input signal before turning the inverter power ON. Keep the input signal voltage to 24V amplitude ($\pm 10\%$) and the Vol to 5V or less. Keep the pulse frequency to 10kHz or less.

The pulse train input can be connected to the internally set signals shown in Table 5-7-3 using the programmable input function.

Table 5-7-3 Types of internally set signals for assigning pulse train input

Signal name	Setting method	Setting range	Function
		F ₁ Hz to F ₂ Hz	
Speed setting	C02-0 = 5	0 to 100%	This is the speed setting.
Traverse center frequency setting	C02-1 = 5	0 to 100%	This is the center frequency setting for traverse operation.
Torque setting	C02-2 = 5	0 to 300%	This is the torque setting for ACR operation. The torque setting can also be limited with the torque limiter (A11-2, 3).

(Note 1) These signals cannot be used at the same time. Set only one of C-2-0 to 2 to "5" when using the pulse train input function.

Refer to Fig.5-7-3-a and set the setting range (F₁Hz to F₂Hz) with parameters C12-C and C12-D.

(Note 2) When assigning to the torque setting, the maximum setting input value is 300%.

(Note 3) If a frequency less than F₁Hz or more than F₂Hz is input, the speed setting and traverse center frequency will be limited to 0 to 100%, and the torque setting will be limited to 0 to 300%.

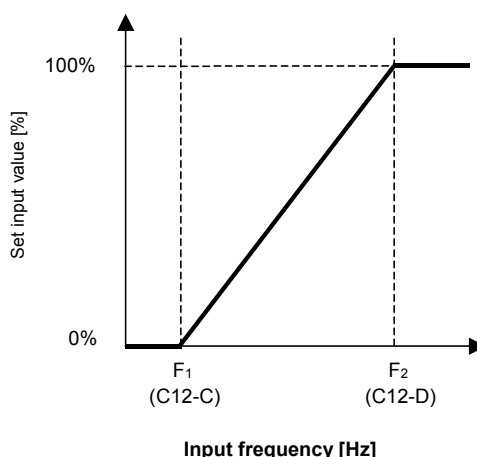

Fig. 5-7-3-a

The pulse train input circuit diagram is shown in Fig. 5-7-3-b.

5. Control Input/Output

After the pulse train signal frequency is detected with the frequency detector, LPF is inserted in that frequency value.

Set this LPF time constant with C12-E. When C12-E is set to "0", that LFP is passed.

If the input signal edge is not detected by the internal counter within the C12-F setting time, it will be judged that the input signal has turned OFF, and the set input value will be handled as 0. Set the C12-F setting time larger than $(1/F1)[s]$.

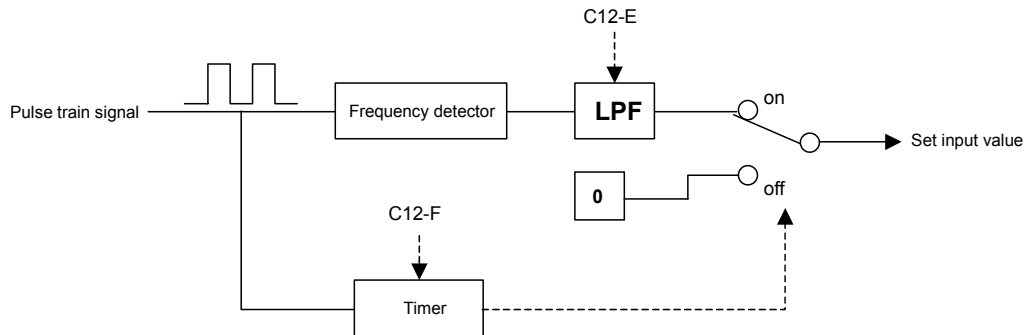

Fig. 5-7-3-b Pulse train input circuit diagram

5-8 Programmable output function (P0)

5-8-1 Types of analog outputs

As a standard, there are 2 channels for the analog output (10-bit). As shown in Fig. 5-8-2, internal data can be assigned to the A01 and A02 terminals.

The voltage output and current output can be selected for A01 and A02 by setting parameter C14-7, 8 and L bit W3, W4.

The default setting is shown below.

Default settings

Terminal symbol	Setting	
A01	Output frequency	0 to 10V voltage output mode
A02	Output current (Motor)	0 to 10V voltage output mode

Example 5-3) Set as shown below for voltage output mode 0 to 10V.

A01: C14-7=1 (0 to 10V voltage output mode selection), Set W3 to 1 (voltage mode)

A02: C14-8=1 (0 to 10V voltage output mode selection), Set W4 to 1 (voltage mode)

Example 5-4) Set as shown below for current output mode 4 to 20mA

A01: C14-7=3 (4 to 20mA output mode selection), Set W3 to 2 (current mode)

A02: C14-8=3 (4 to 20mA output mode selection), Set W4 to 2 (current mode)

5-8-2 Setting the analog output

A following internal data can be output to A01, A02 terminals with parameters C13-0 and 1 as shown in Fig. 5-8-2. The setting is completed by setting the output data number in C13-0 and 1. If the gain needs to be adjusted, use C14-0, 1. Signed data can be output by setting the offset voltage with C14-3, 4 and setting the offset current with C14-5, 6.

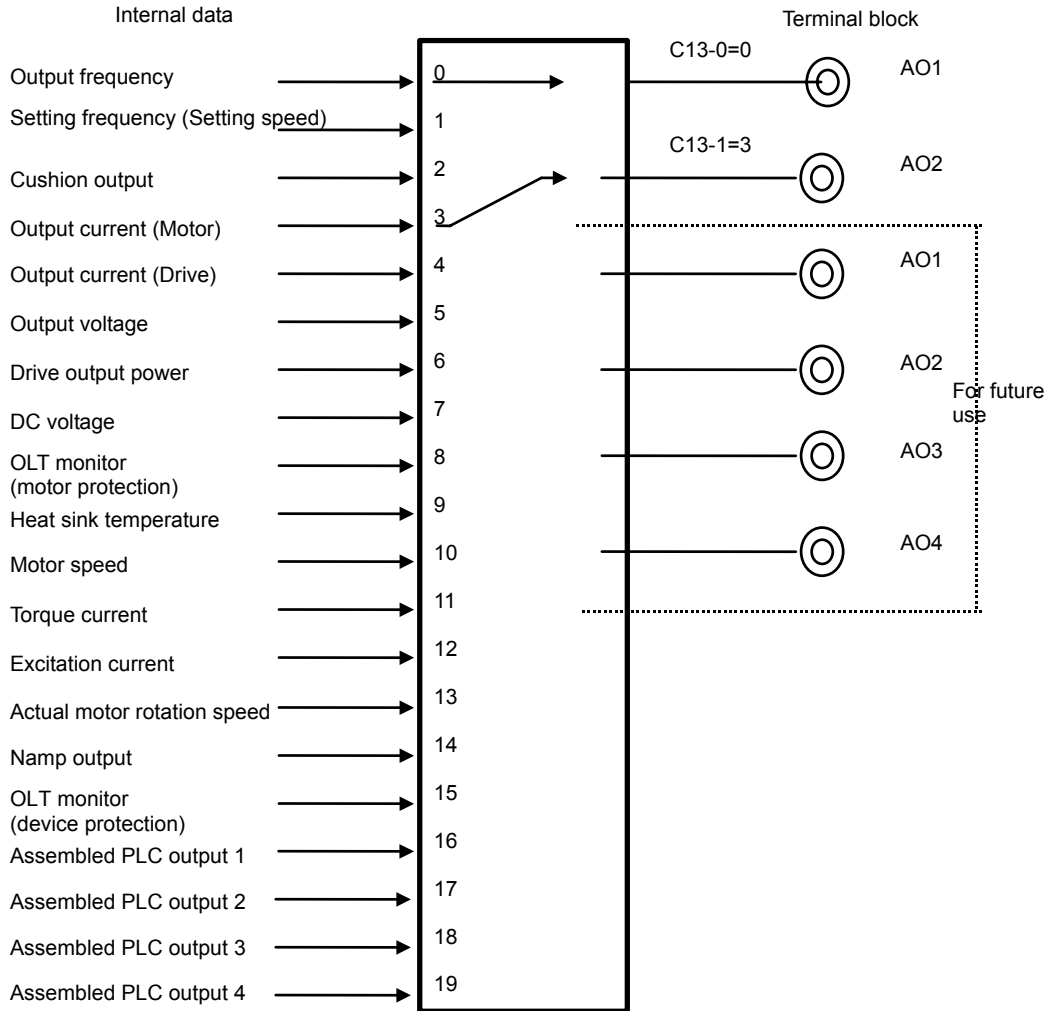

Fig. 5-8-2 Analog output assignment

5-8-3 Pulse train output

The pulse train output is one channel, and can be output from PS03 on the terminal block output. Internal data can be assigned and output as a pulse train. If PS03 is assigned to the pulse train output function, it cannot be used as a sequence output. Note that when this function is used, the speed detection option I pulse division function (C50-0) cannot be used.

(Note) The maximum output frequency is 6kHz (25°C). Use the falling edge.

Set the control PCB as shown below for using the pulse train output function.

- Turn the DIP switch (DS1-4) ON.
- Set PS03 output setting (C13-5) to OFF fixed (=0).

(Note) An incorrect DS1 setting can result in faults.

Similarly, incorrect parameter settings could result in faults.

Observe the precautions for the sequence output (open collector output) and connect the device to PS03.

The settings for using the pulse train output function are shown below.

- 1) Set C13-B to 2 to use the pulse train output function.

Parameter No.	Name	Function
C13-B	Pulse train output function	=1 : Pulse train output function OFF
		=2 : Pulse train output function ON

- 2) Set the internal data to be output as a pulse train with C13-E as shown in Fig. 5-8-3-a.

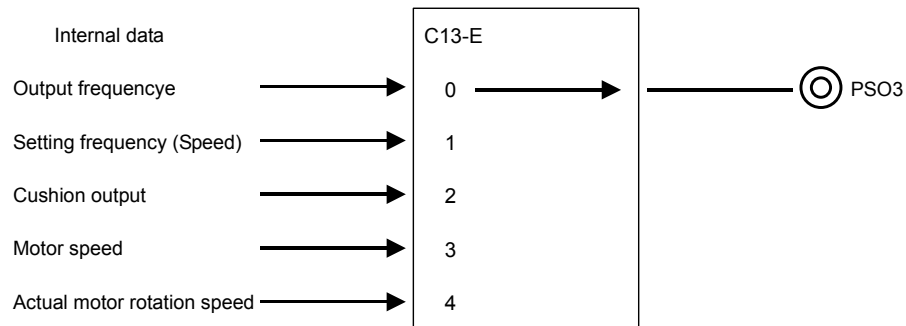

Fig. 5-8-3-a Pulse train output assignments

5. Control Input/Output

- 3) Refer to Fig. 5-8-3-b, and set the frequency of the pulses output with C13-C, D.
To output the absolute value of the internal data, set C13-F to 2.

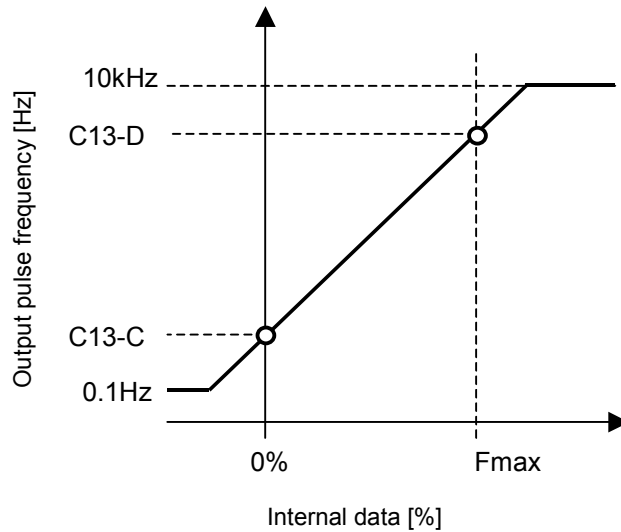

Fig. 5-8-3-b

- (Note)** The output pulse frequency range is 0.1 to 10kHz.
A pulse less than 0.1Hz cannot be output even during reverse run.
When outputting from the sequence output PS03, only a pulse frequency of 6kHz or less (25°C, maximum current = 50mA) can be output. Set C13-C, D to 6000Hz or less.

Parameter No.	Name	Function
C13-F	Output parameter absolute value operation selection	=1 : Internal data absolute value operation function ON =2 : Internal data absolute value operation function OFF

5-9 Selecting the setting data

5-9-1 Speed setting

(1) Speed setting selection

The ten types of speed setting inputs shown below can be used.

One of the ten types of inputs can be selected by setting a parameter or with the sequence input.

Setting input point	Setting data	Explanation
Analog	Analog speed setting 1 Analog speed setting 2 Analog speed setting 3	This is a setting value issued with an analog input.
Serial	Serial speed setting	This is a setting value issued from the host computer with serial transmission. Setting is possible with the following serial transmission. • Communication interface option (Type: V24-SL0/1/2/3/4) • Standard serial transmission •Modbus communication
Parallel	Parallel speed setting	This is a setting value issued from the host sequencer with parallel transmission. A PC interface option (type: V24-PI0) is required.
Sequence	Pulse train speed setting	This is the setting value issued from the pulse train input.
Panel	Panel speed setting	This is the setting value issued from the parameter (A00-0, 2).
	Panel jogging setting	This is a setting value issued from the parameter (A00-1, 3).
	Traverse pattern operation	This is the traverse pattern operation setting value with parameter (B45-0 to 6).
	Pattern operation	This is the pattern operation setting value with parameter (B50-0 to B59-3).

(2) Speed setting selection sequence

The relation of the speed setting and changeover sequence is as shown below.

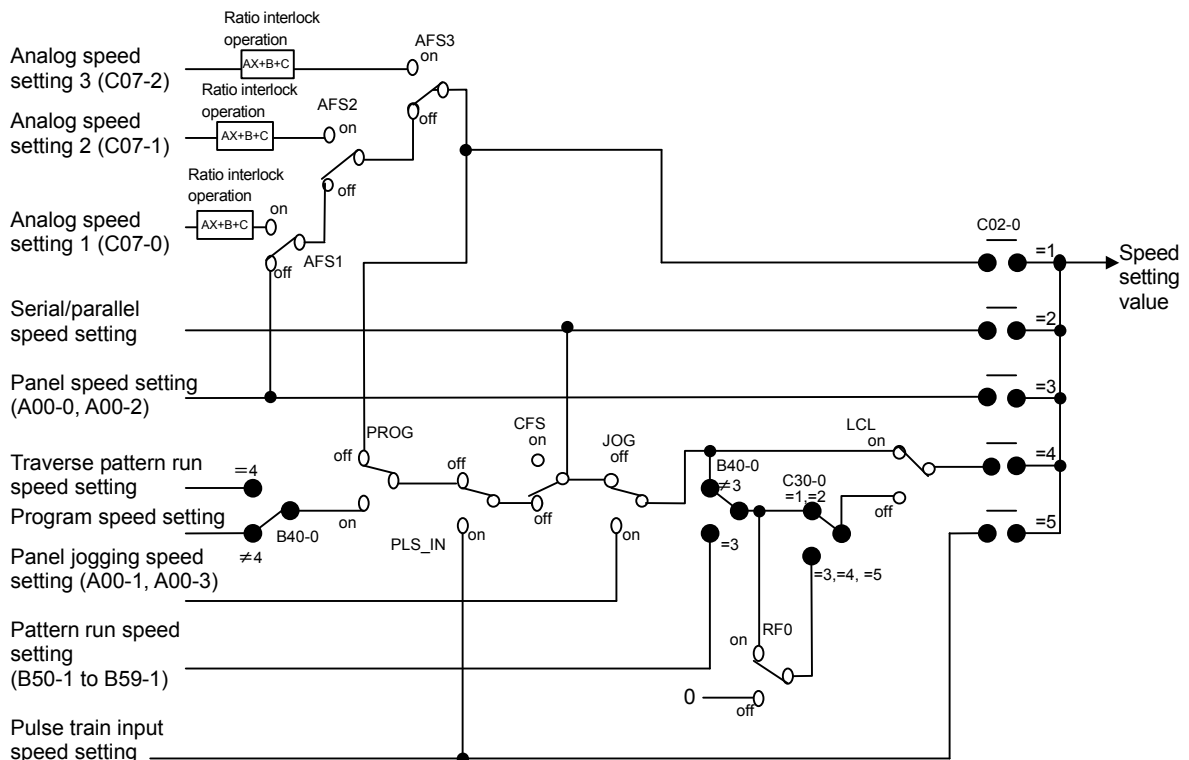

Fig. 5-9-1 Speed setting selection

5-9-2 Torque setting

(1) Torque setting selection

The following four types of torque setting inputs can be used.

One of the four types of inputs can be selected by setting a parameter or with the sequence input.

Setting input point	Setting data	Explanation
Analog	Analog torque setting	This is a setting value issued from the analog input.
Serial	Serial torque setting	This is a setting value issued from the host computer with serial transmission. Setting is possible with the following serial transmission. <ul style="list-style-type: none"> • Communication interface option (Type: V24-SL0/1/2/3/4) • Standard serial transmission • Modbus communication
Sequence	Pulse train speed setting	This is the setting value issued from the pulse train input.
Panel	Panel torque setting	This is a setting value issued from the parameter (B13-0).

(2) Torque setting selection sequence

The relation of the torque setting and changeover sequence is as shown below.

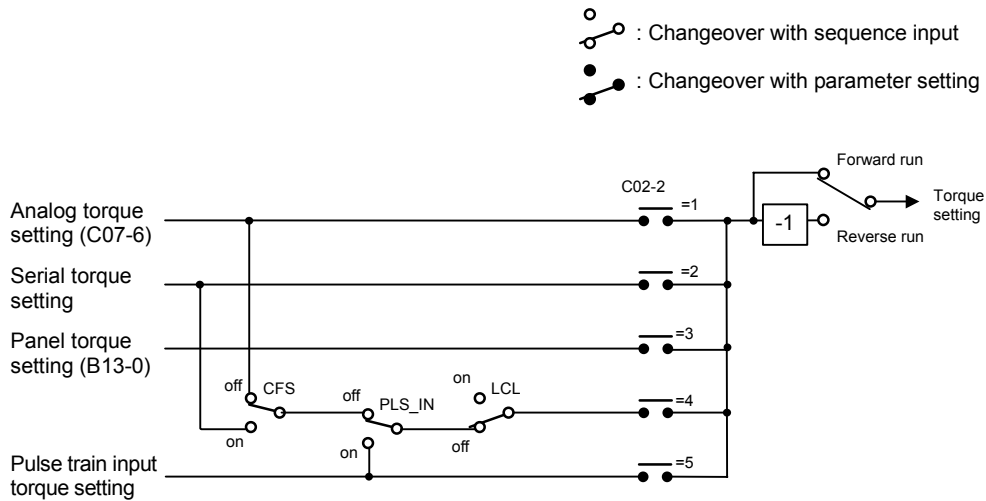

Fig. 5-9-2 Torque setting selection

5-9-3 Torque bias 1 setting

(1) Torque bias 1 setting selection

The following three types of torque bias 1 setting inputs can be used.
One of the three types of inputs can be selected by setting a parameter or with the sequence input.

Setting input point	Setting data	Explanation
Analog	Analog torque bias 1 setting	This is a setting value issued from the analog input.
Serial	Serial torque bias 1 setting	This is a setting value issued from the host computer with serial transmission. Setting is possible with the following serial transmission. • Communication interface option (Type: V24-SL0/1/2/3/4) • Standard serial transmission •Modbus communication
Panel	Panel torque bias 1 setting	This is a setting value issued from the parameter (B13-2).

(2) Torque bias 1 setting selection sequence

The relation of the torque bias 1 setting and changeover sequence is as shown below.

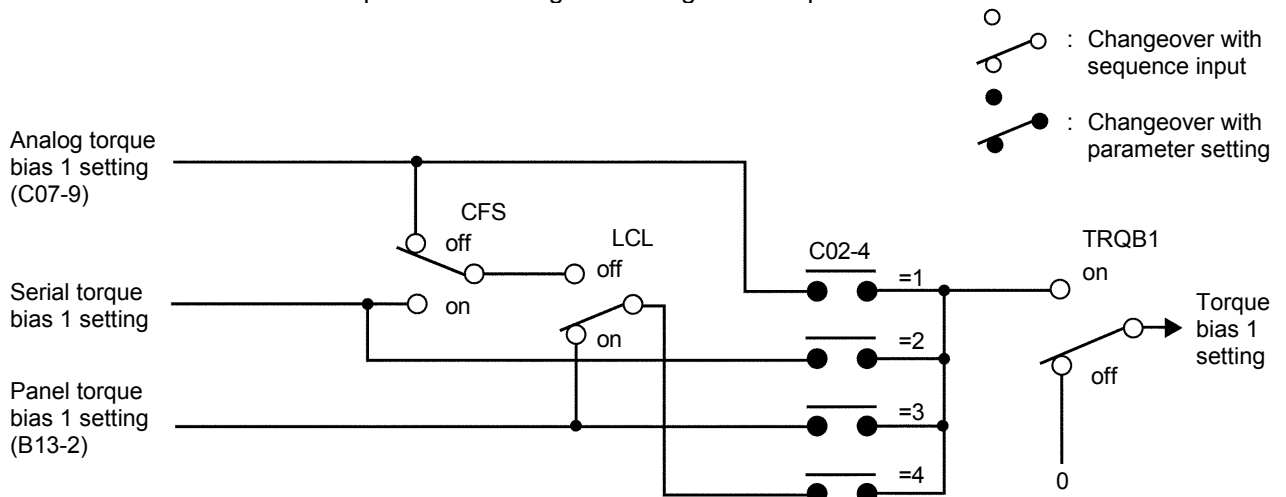

Fig. 5-9-3 Torque bias 1 setting selection

5-9-4 Torque limiter setting

(1) Torque limiter reduction setting selection

The torque limiter can be set independently for the drive side and regeneration side in the ASR mode and ACR mode. The setting parameters are as shown below. If the emergency stop sequence is valid, the regeneration side limiter value will become the emergency stop limiter value.

- A10-3 : ASR drive torque limiter setting
- A10-4 : ASR regenerative torque limiter setting
- A10-5 : Emergency stop regenerative torque limiter setting
- A11-2 : ACR drive torque limiter setting
- A11-3 : ACR regenerative torque limiter setting

For each limiter input, the limiter value can be reduced by external or internal settings. The final limiter value is the results of multiplying the above panel setting values with the reduction ratio.

5. Control Input/Output

(1-1) External reduction setting

The limiter reduction setting input from an external source includes the following two types independently for the drive and regeneration.

One of the two types of inputs can be selected by setting a parameter or with the sequence input.

Setting input point	Setting data	Explanation
Analog	Analog drive torque limiter reduction setting	This is a setting value issued with an analog input. The drive torque limit (A10-3 or A11-2) is multiplied using 0V to +10V as 0 to 100%, and the limit value is reduced. This function is valid when the drive limiter changeover (LIM1) is turned ON with the sequence input.
	Analog regenerative torque limiter reduction setting	This is a setting value issued with an analog input. The regenerative torque limit (A10-4, A10-5 or A11-3) is multiplied using 0V to +10V as 0 to 100%, and the limit value is reduced. This function is valid when the regenerative limiter changeover (LIM2) is turned ON with the sequence input.
Serial	Serial driver torque limiter reduction setting	This is a setting value issued from the host computer with serial transmission. Setting is possible with the following serial transmission. <ul style="list-style-type: none"> • Communication interface option (Type: V24-SL0/1/2/3/4) • Standard serial transmission • Modbus communication The data is set in the range of 0 to 100%, is multiplied with the drive torque limiter value (A10-3, A11-2), and the limiter value is reduced. This function is valid when the drive limiter changeover (LIM1) is turned ON with the sequence input.
	Serial regenerative torque limiter reduction setting	This is a setting value issued from the host computer with serial transmission. Setting is possible with the following serial transmission. <ul style="list-style-type: none"> • Communication interface option (Type: V24-SL0/1/2/3/4) • Standard serial transmission • Modbus communication The data is set in the range of 0 to 100%, is multiplied with the regenerative torque limiter value (A10-4, A10-5, A11-3), and the limiter value is reduced. This function is valid when the regenerative limiter changeover (LIM2) is turned ON with the sequence input.

(1-2) Internal reduction setting

When the double rating speed ratio setting (B13-4) is changed, the torque limiter reduction pattern will be generated as shown below, and will be multiplied with the drive torque limiter value (A10-3 or A11-2) and regenerative torque limiter value (A10-4, A10-5, A11-3).

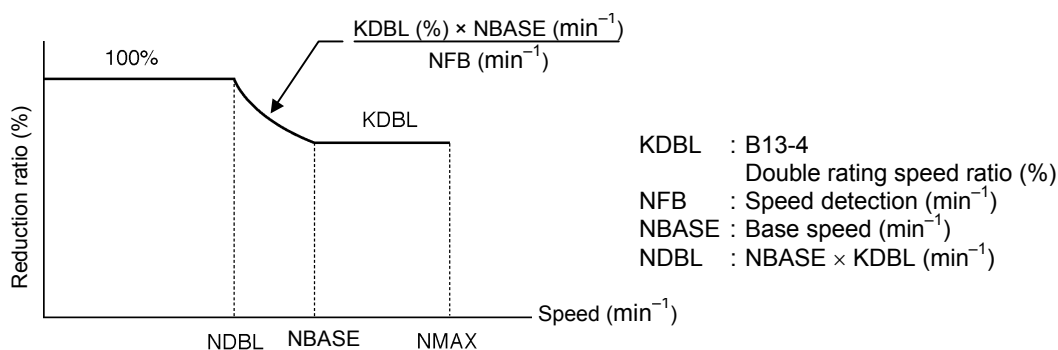

5. Control Input/Output

(2) Torque limiter setting selection sequence

The relation of the torque limiter setting and changeover sequence is as shown below.

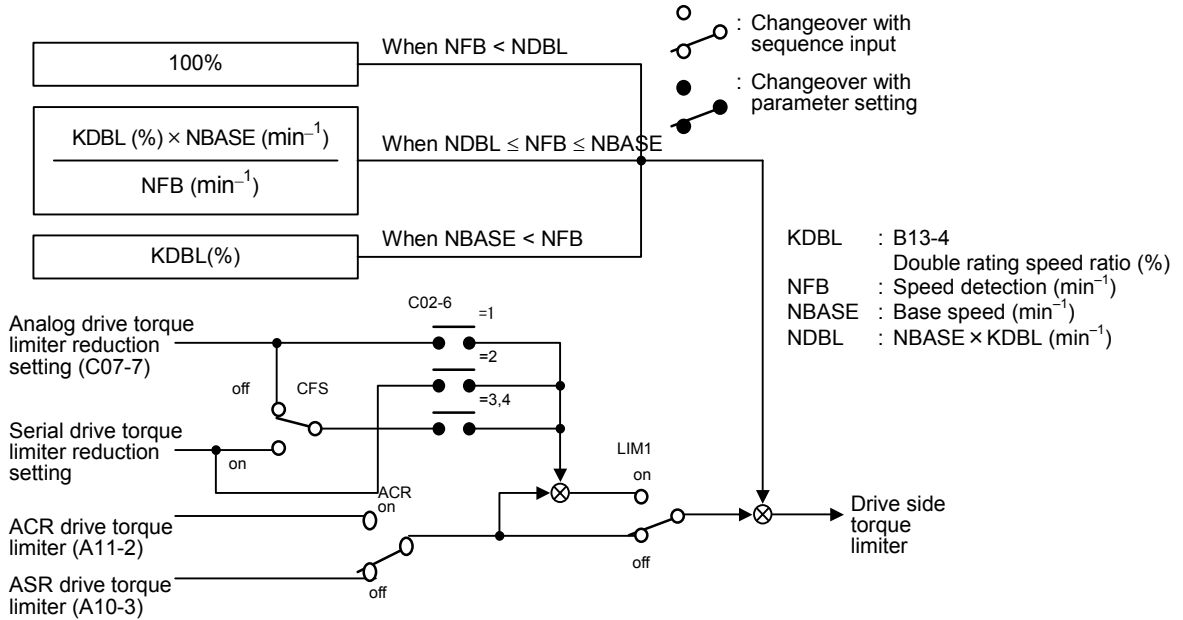

Fig. 5-9-4-a Drive torque limiter setting selection

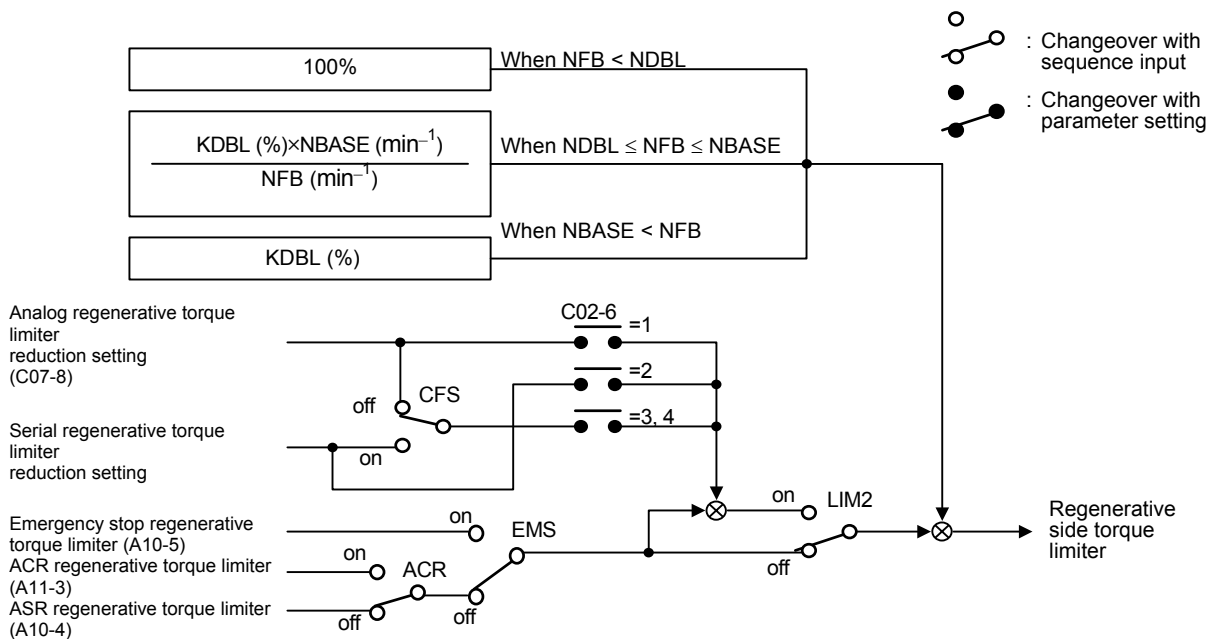

Fig. 5-9-4-b Regenerative torque limiter setting selection

5-9-5 Torque ratio 1 setting

(1) Torque ratio 1 setting selection

The following two types of torque ratio 1 setting inputs can be used.

One of the two types of inputs can be selected by setting a parameter or with the sequence input.

Setting input point	Setting data	Explanation
Serial	Torque ratio 1 setting	This is a setting value issued from the host computer with serial transmission. Setting is possible with the Communication interface option (Type: V24-SL0/1/2/3/4).
Panel	Panel torque ratio 1 setting	This is a setting value issued from the parameter (B13-1).

(2) Torque ratio 1 setting selection sequence

The relation of the torque ratio 1 setting and changeover sequence is as shown below.

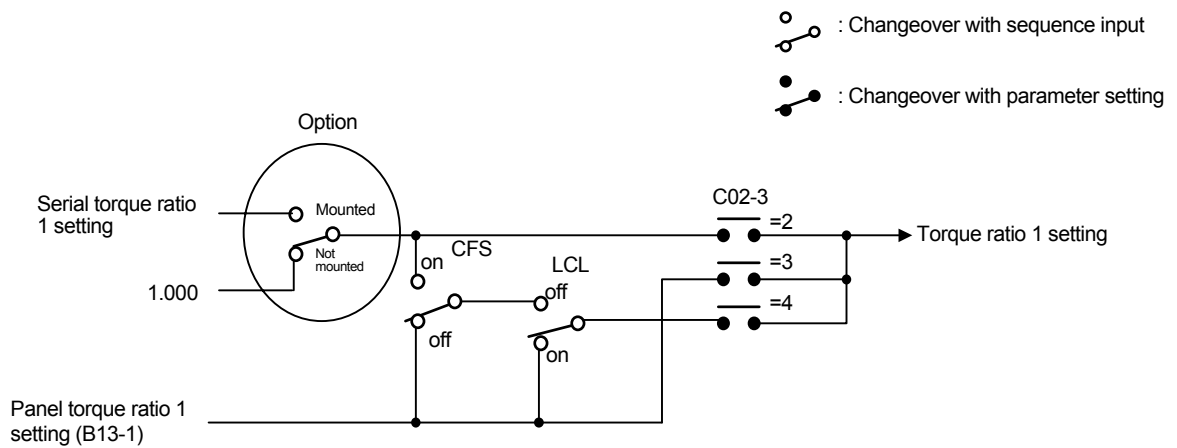

Fig. 5-9-5 Torque ratio 1 setting selection

5-9-6 Torque ratio 2, torque bias 2 setting

(1) Torque ratio 2 setting selection

The following two types of torque ratio 2 setting inputs can be used.

One of the two types of inputs can be selected by setting a parameter or with the sequence input.

Setting input point	Setting data	Explanation
Serial	Torque ratio 2 setting	This is a setting value issued from the host computer with serial transmission. Setting is possible with the Communication interface option (Type: V24-SL0/1/2/3/4).
Panel	Panel torque ratio 2 setting	This is a setting value issued from the parameter (B13-3).

(2) Torque ratio 2 setting selection sequence

The relation of the torque ratio 2 setting and changeover sequence is as shown below.

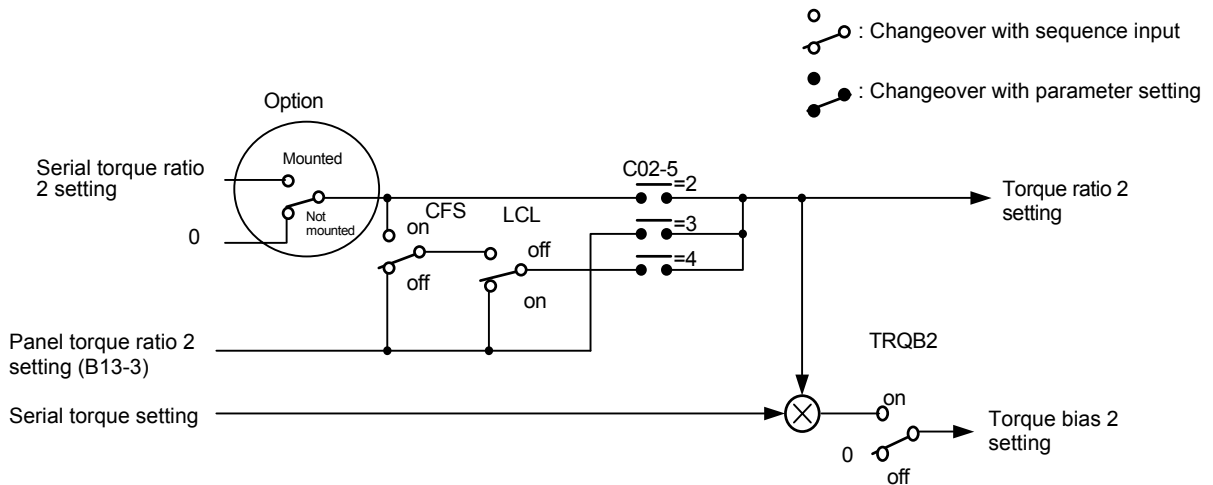

Fig. 5-9-6 Torque ratio 2 setting selection

5-9-7 Machine time constant setting

(1) Machine time constant setting

The following three types of machine time constant setting inputs can be used.
One of the three types of inputs can be selected by setting a parameter or with the sequence input.

Setting input point	Setting data	Explanation
Serial	Machine time constant	This is a setting value issued from the host computer with serial transmission. Setting is possible with the Communication interface option (Type: V24-SL0/1/2/3/4).
Panel	Panel machine time constant -1	This is a setting value issued from the parameter (A10-1).
	Panel machine time constant -2	This is a setting value issued from the parameter (B15-0).

(2) Machine time constant setting and changeover sequence

The relation of the machine time constant setting and changeover sequence is as shown below.

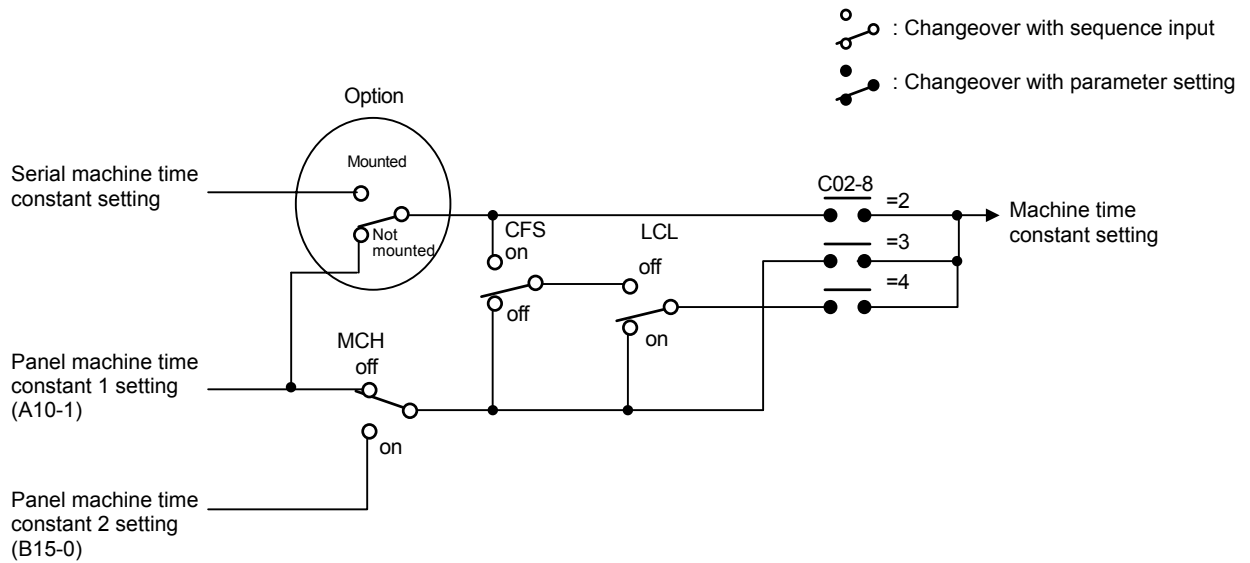

Fig. 5-9-7 Machine time constant setting selection

5-9-8 ASR response setting

(1) ASR response setting selection

The following two types of ASR response setting inputs can be used.
 One of the two types of inputs can be selected by setting a parameter or with the sequence input.

Setting input point	Setting data	Explanation
Serial	ASR response setting	This is a setting value issued from the host computer with serial transmission. Setting is possible with the Communication interface option (Type: V24-SL0/1/2/3/4).
Panel	Panel ASR response setting	This is a setting value issued from the parameter (A10-0).

(2) ASR response setting and changeover sequence

The relation of the ASR response setting and changeover sequence is as shown below.

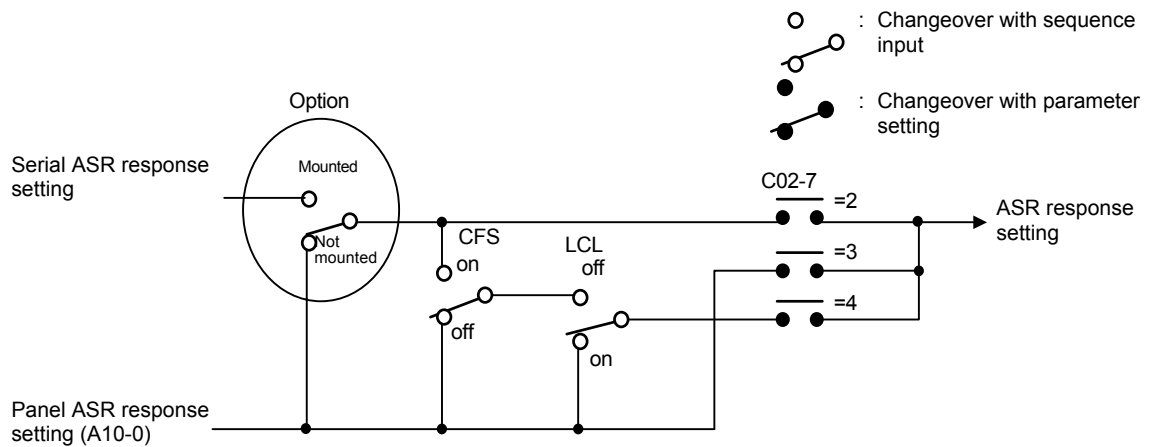

Fig. 5-9-8 ASR response setting selection

Chapter 6 Control Functions and Parameter Settings

6-1 Monitor parameters

The monitor mode sequentially displays the frequency, power supply, etc., parameters recognized by the VT240S.

The symbols shown at the right of the list show the application of each parameter as shown below.

V/f : Indicates parameters that apply for V/f control (constant torque, variable torque) (C30-0: f0 = 1).

VEC : Indicates parameters that apply for IM speed sensor-less vector control and IM speed vector control with sensor (C30-0: f0 = 2, 3).

PM : Indicates parameters that apply for control mode with PM motor sensor (C30-0: f0 = 4).

Monitor parameters list

No.	Parameter	Unit	Remarks	Application		
				V/f	VEC	PM
D00 – Output frequency monitor						
0	Output frequency in Hz	Hz	ⓂⓂⓂ will display when the gate is closed.	○	○	○
1	Output frequency in %	%	ⓂⓂ displays while the DC brake is in action. ⓂⓂ is displayed during pick up.	○	○	○
2	Motor speed in min ⁻¹	min ⁻¹	The forward run direction is displayed with the + polarity, and the reverse run direction with the – polarity. (This is displayed even when stopped.)		○	○
3	Motor speed in %	%				
4	Output frequency/motor speed random scale display		When V/f control operation (C30-0: f0 = 1) or auxiliary drive operation is selected, a value obtained by multiplying D00-0: output frequency with the random scale display coefficient: C14-2 will be displayed. When IM vector control or PM motor control (C30-0: f0 = 2 to 4) is selected, a value obtained by multiplying D00-2: motor speed with the random scale display coefficient, C14-2 will be displayed. If the value exceeds the range of -99999 to 99999, ⓂⓂⓂⓂ will be displayed.	○	○	○
5	Motor rotation speed	%	This displays the detected rotation speed for V/f or sensorless vector control in the case where the unit is equipped with a speed detection option.	○	○	○
D01 – Frequency setting monitor						
0	Set frequency in Hz	Hz	The currently selected frequency setting value is displayed.	○		
1	Set frequency in %	%	The max. frequency is displayed as 100%.	○		
2	Ramp function output speed	min ⁻¹	The set speed at ASR input point is displayed. The forward run direction is displayed with the + polarity, and the reverse run direction with the – polarity.		○	○
3	Ramp function input speed	min ⁻¹	The set speed at the ramp function's input point is displayed. The forward run direction is displayed with the + polarity, and the reverse run direction with the – polarity.		○	○
4	Set frequency/input speed /ramp function input Random scale display		When V/f control operation (C30-0: f0 = 1) or auxiliary drive operation is selected, a value obtained by multiplying D01-0: setting frequency with the random scale display coefficient: C14-2 will be displayed. When IM vector control or PM motor control (C30-0: f0 = 2 to 4) is selected, a value obtained by multiplying D01-3: input speed with the random scale display coefficient, C14-2 will be displayed. If the value exceeds the range of -99999 to 99999, ⓂⓂⓂⓂ will be displayed.	○	○	○
D02 – Current monitor						
0	Output current (Amps)	A	ⓂⓂⓂ will display when the gate is closed.	○	○	○
1	Output current (%)	%	The motor rated current is displayed as 100%.	○	○	○
2	Overload (OLT-1) monitor	%	OL-1 functions when this value reaches 100%.	○	○	○
3	Motor overload (OL-3) monitor	%	The OL-3 operates when at 100%.	○	○	○
4	Heatsink temperature	°C	Depending on the capacity, OHT.1 functions at 95°C or 120°C or more.	○	○	○
5	Torque current detection	%	The torque current detection value is displayed using the motor rated current as 100%. The forward run direction torque is displayed with the + polarity, and the reverse run direction torque with the – polarity.		○	○

6. Control Functions and Parameter Settings

Monitor parameters list

No.	Parameter	Unit	Remarks	Application		
				V/f	VEC	PM
D02 – Current monitor						
6	Excitation current detection	%	The excitation current's detection value is displayed using the motor rated current as 100%. With the PM motor control, the demagnetizing current is indicated with – polarity.		○	○
7	U phase output current amps	A	⓪FF will display when the gate is closed. The correct value is not displayed during pick-up or during automatic tuning.	○	○	○
8	V phase output current amps	A	⓪FF will display when the gate is closed. The correct value is not displayed during pick-up or during automatic tuning.	○	○	○
9	W phase output current amps	A	⓪FF will display when the gate is closed. The correct value is not displayed during pick-up or during automatic tuning.	○	○	○
D03 – Voltage monitor						
0	DC voltage	V	Displays the voltage of the DC link circuit in the main circuit.	○	○	○
1	Output voltage (command)	V	Displays output voltage command. The display may differ from the actual output voltage. It depends on the power supply voltage. ⓪FF will display when the gate is closed.	○	○	○
2	Output power	kW	Displays the inverter's output power. ⓪FF will display when the gate is closed.	○	○	○
3	Carrier frequency	kHz	The current carrier frequency is displayed.	○	○	○
D04 – Sequence status						
0-3	Sequence status-Input 1 to 4		The ON/OFF state of the internal sequence data will display. The correspondence of each LED segment and signal is shown in the next page.	○	○	○
4-7	Sequence status-Output 1 to 4			○	○	○
D05 – Minor fault monitor						
0	Minor fault failure monitor		The internal minor fault status will display. The correspondence of each LED segment and signal is shown in the next page.	○	○	○
1	ASIC breakdown monitor		The internal ASIC fault status is displayed.	○	○	○
D06 – Pattern run monitor						
0	Step No. monitor		The current step No. will display.	○	○	○
1	Remaining time monitor	s	The remaining time of current step will display	○	○	○
D07 – Pump operation status monitor						
0	Pump operation status monitor		This indicates the ON/OFF status of the pump. The correspondence of the LED segments and signals is shown below.	○		
1	Current inverter drive pump No. monitor		This displays the number of the pump currently driven by the inverter.	○		
2	Next ON pump No. monitor		0 is displayed when all pumps are ON.	○		
3	Next OFF pump No. monitor		0 is displayed when all pumps are OFF.	○		
4	Elapsed time		The main pump's operation time is displayed.	○		
D08 – Analog input random scale display						
0	A11 input scale display (max. frequency/speed reference)		Value to which coefficient set at C14-9 displays for A11 input. [OVER] displays if the coefficient exceeds the –99999. to 99999. range.	○	○	○
1	A12 input scale display (max. frequency/speed reference)		Value to which coefficient set at C14-A displays for A12 input. [OVER] displays if the coefficient exceeds the –99999. to 99999. range.	○	○	○
2	A13 input scale display (max. frequency/speed reference)		Value to which coefficient set at C14-B displays for A13 input. [OVER] displays if the coefficient exceeds the –99999. to 99999. range.	○	○	○

6. Control Functions and Parameter Settings

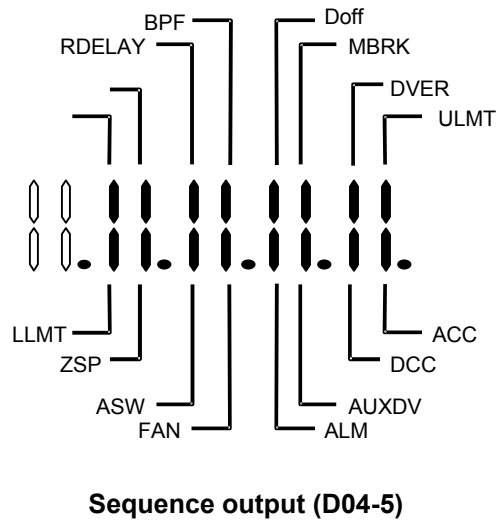
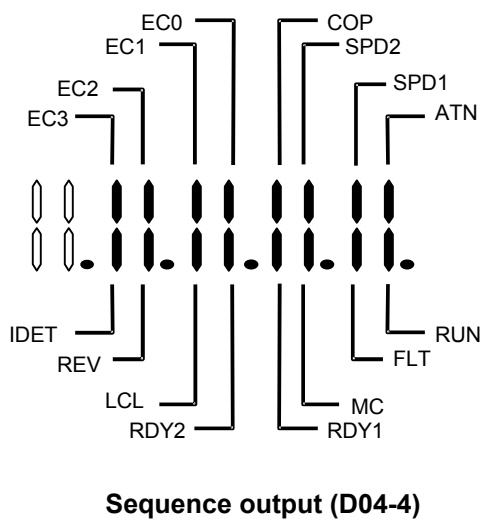
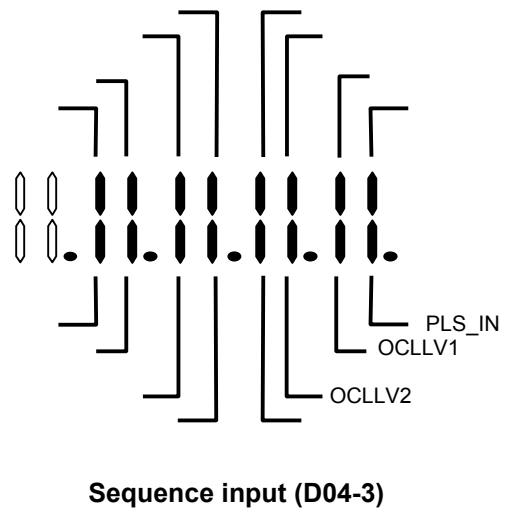
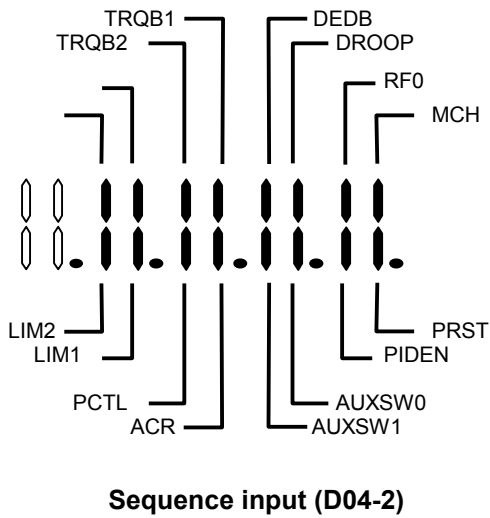
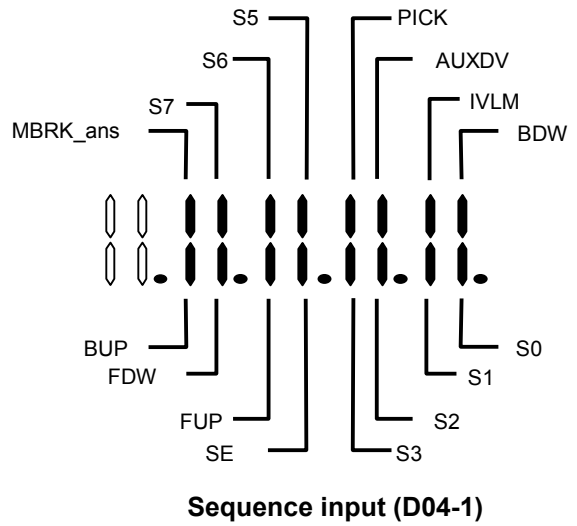
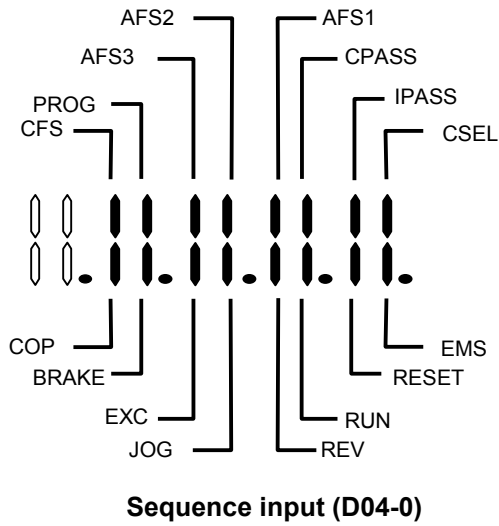

6. Control Functions and Parameter Settings

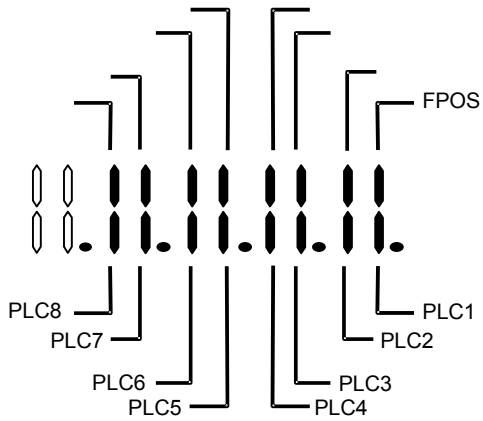

Sequence output (D04-6)

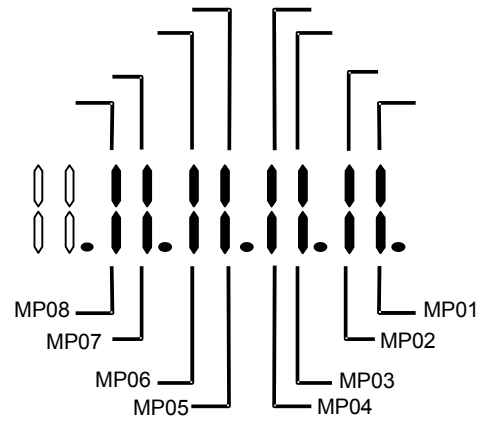

Sequence output (D04-7)

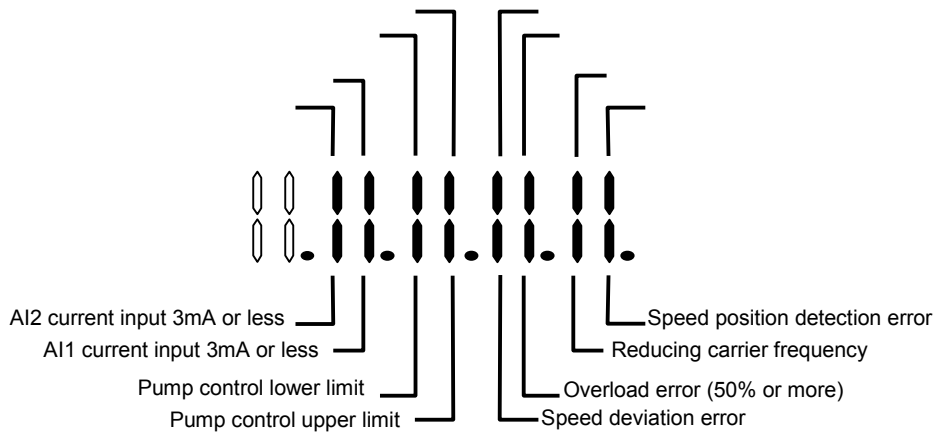

Monitor fault (D05-0)

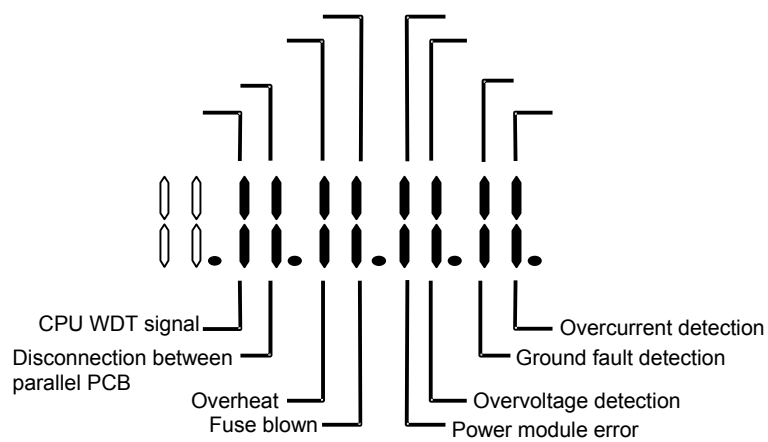

ASIC error displays (D05-1)

6. Control Functions and Parameter Settings

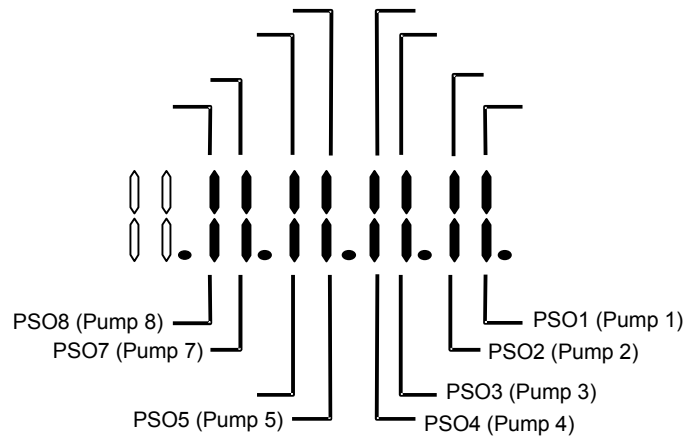

Pump operation status monitor (D07-0)

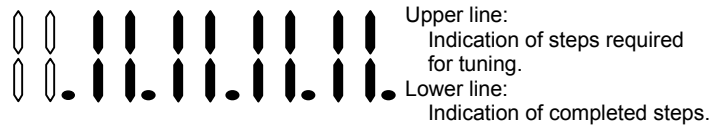

Automatic tuning progress state (D22-0)

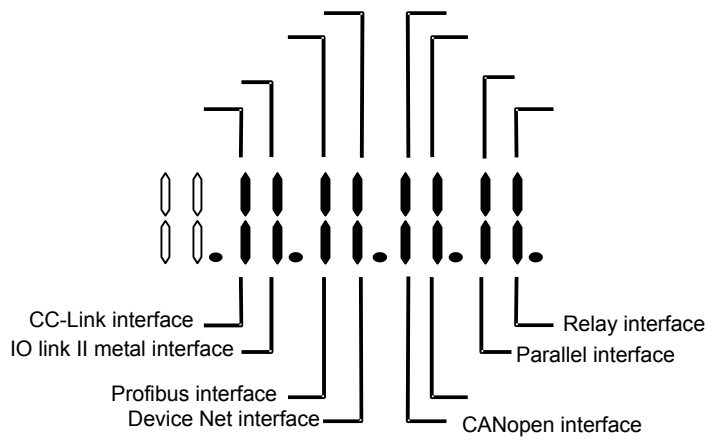

Option P.C.B. monitor (D30-1)

6. Control Functions and Parameter Settings

Monitor parameters list

No.	Parameter	Unit	Remarks	Application		
				V/f	VEC	PM
D10– Built-in PLC monitor						
0	Built-in PLC display 1		The contents of address 36 for the built-in PLC memory are displayed.	○	○	○
1	Built-in PLC display 2		The contents of address 37 for the built-in PLC memory are displayed.	○	○	○
2	Built-in PLC display 3		The contents of address 38 for the built-in PLC memory are displayed.	○	○	○
3	Built-in PLC display 4		The contents of address 39 for the built-in PLC memory are displayed.	○	○	○
D11 – Torque setting monitor						
0	Torque setting input monitor	%	The currently selected torque setting of the current control input points is selected.		○	○
1	Analog torque setting monitor	%	The setting value input from the analog torque setting is displayed.		○	○
2	Serial communication torque setting monitor	%	The setting value input from the serial communication torque setting is displayed.		○	○
3	Operation panel torque setting monitor	%	The torque set with the operation panel (B13-0) is displayed.		○	○
4	ASR output monitor	%	The ASR output is displayed.		○	○
5	Torque setting monitor (after torque limiter)	%	The forward run direction torque is displayed with the + polarity, and the reverse run direction torque with the – polarity.		○	○
D12 – Slip						
0	Slip monitor	%	The slip is displayed as a percentage in respect to the base speed.		○	
D13 – STP run monitor						
0	STP step No. monitor		FF displays during stoppage.	○		
1	STP remaining pattern time monitor	min	Displays the time remaining until the end of the current pattern.	○		
2	STP No. monitor		Displays the currently selected STP.	○		
3	STP average spindle frequency monitor	Hz	Displays the average frequency for each spindle.	○		
4	STP hank count monitor		Displays the current Hank count. The display is limited at a maximum of 6553.5. This is cleared to zero when the power is turned OFF.	○		
5	STP total patter operating time monitor	min	Displays the operation time until now. The display is limited at a maximum of 65535. This is cleared to zero when the power is turned OFF.	○		
D14 – Automatic torque bias						
0	Automatic torque bias setting	%	Displays the currently set torque bias value at the analog/digital auto torque bias setting.		○	○
D15 – Electric angle monitor						
0	Z-phase electric angle	°	The Z-phase electric angle is displayed. Use this to adjust the Z-phase when using magnetic pole position estimation.			○
D16 – Magnetic pole position estimation monitor						
0	Characteristics amount for magnetic pole position estimation 1	%	The characteristics amount in the estimation results is displayed.			○
1	Characteristics amount for magnetic pole position estimation 2	%	The characteristics amount in the estimation results is displayed.			○
2	Magnetic pole position estimation current	%	The current measured for the N pole phase in the estimation results is displayed.			○
3	Magnetic pole position estimation error	°	The error of the phase angles in the magnetic pole position estimate is displayed.			○

6. Control Functions and Parameter Settings

Monitor parameters list

No.	Parameter	Unit	Remarks	Application		
				V/f	VEC	PM
D20 – Extended monitor						
0	Fault history monitor		The fault history reference mode will display when [SET] is pressed.	○	○	○
1	Minor failure past record indication		The minor fault history reference mode will display when [SET] is pressed.	○	○	○
2	Parameter A, B and C modification list entry		The mode for referring to and changing parameters that differ from the default value will display [SET] is pressed.	○	○	○
3	Sequence input display (dedicated for LCD panel)		The sequence input reference mode will display when [SET] is pressed. This parameter does not appear when the LED panel is connected.	○	○	○
4	Sequence output display (dedicated for LCD panel)		The sequence output reference mode will display when [SET] is pressed. This parameter does not appear when the LED panel is connected.	○	○	○
D21 – Maintenance monitor						
0	Cumulative conductivity time	h.	The cumulative power ON time after product shipment will be counted and displayed.	○	○	○
1	Cumulative run time	h.	The cumulative run time after product shipment will be counted and displayed.	○	○	○
2	CPU version		Display for maker control.	○	○	○
3	ROM version		Display for maker control.	○	○	○
D22 – Automatic tuning						
0	Automatic tuning progression display		The progression state of automatic tuning is displayed. The correspondence of the LED's segments and signals is shown in the previous section.	○	○	
D30 – Hardware monitor						
0	Inverter type		This indicates the inverter type.	○	○	○
1	Option PCB		Displays the mounted option PCB. The correspondence of the LED segments and signals is shown in the previous page.	○	○	○

6. Control Functions and Parameter Settings

6-2 Block-A parameters

The parameters used most frequently have been grouped in Block-A.

V/f : Indicates parameters that apply for V/f control (constant torque, variable torque) (C30-0: f0 = 1).

VEC : Indicates parameters that apply for IM speed sensor-less vector control and IM speed vector control with sensor (C30-0: f0 = 2, 3).

PM : Indicates parameters that apply for control mode with PM motor sensor (C30-0: f0 = 4).

RWE : Displays the parameters that can be changed during operation.

Reference page: The number of the page providing detailed explanations is indicated.

Block-A parameters list

No.	Parameter	Min.	Max.	Default (Unit)	Function	Application				Ref. page
						V/f	VEC	PM	RWE	
A00 – Frequency setting										
0	Local frequency setting	0.10	Max. frequency	10.00 (Hz)	This is the frequency set from the operation panel.	○			○	6-86
1	Jogging frequency	0.10		5.00 (Hz)	This is the frequency setting for jogging.	○			○	6-86
2	Local speed setting	-Max. speed	Max. speed	300. (min ⁻¹)	This is the speed set from the operation panel.		○	○	○	6-86
3	Jogging speed			100. (min ⁻¹)	This is the speed setting for jogging		○	○	○	6-86
A01 – Acceleration/deceleration time										
0	Acceleration time – 1	0.1	6000.0	10.0 (s)	The value can be displayed in units of 0.1 or 10 times as set on B10-5.	○	○	○	○	6-86
1	Deceleration time – 1	0.1	6000.0	20.0 (s)	The time to reach the max. frequency or max. speed from 0 is set.	○	○	○	○	6-86
A02 – Torque boost										
0	Manual torque boost selection	1.	2.	2.	1: Disable = 2: Enable	○				6-87
1	Automatic torque boost selection	1.	2.	1.	1: Disable = 2: Enable	○				6-87
2	Manual torque boost setting	0.00	20.00	Inverter rating (%)	Set the boost voltage at 0Hz. This is automatically adjusted by the automatic tuning.	○			○	6-89
3	Square reduction torque setting	0.00	25.00	0.00 (%)	Set the reduced voltage at Base frequency/2.	○			○	6-89
4	R1 drop compensation gain	0.0	100.0	100.0 (%)	Set how much to compensate the voltage drop caused by R1 measured with automatic tuning.	○			○	6-89
5	Slip compensation gain	0.00	20.00	0.00 (%)	Set the motor's rated slip. This is automatically adjusted by the automatic tuning.	○			○	6-90
6	Maximum torque boost gain	0.00	50.00	0.00 (%)	This is automatically adjusted by the automatic tuning. The optimum boost amount for outputting the maximum torque is set.	○				6-90
A03 – DC Brake										
0	DC braking voltage	0.01	20.00	Inverter rating (%)	This is automatically adjusted by the automatic tuning. When setting manually, monitor the output voltage and change the setting in increments of 1% or less.	○			○	6-86
1	DC braking time	0.0	20.0	2.0 (s)	Set the time to apply the DC brakes.	○	○	○	○	6-86
2	DC braking current	0.	150.	50. (%)	This is used instead of the DC brake voltage in the vector mode and PM mode. This is not adjusted with automatic tuning.		○	○	○	6-86

6. Control Functions and Parameter Settings

Block-A parameters list

No.	Parameter	Min.	Max.	Default (Unit)	Function	Application				Ref. page
						Vf	VEC	PM	RWE	
A04 – Custom parameters										
0	Custom parameters – 0				Set the parameter Nos. to be displayed in this block in C10-0~7. This block displays when the above settings are not made.	<input type="checkbox"/>	<input type="checkbox"/>	<input type="checkbox"/>	<input type="checkbox"/>	6-90
1	Custom parameters – 1					<input type="checkbox"/>	<input type="checkbox"/>	<input type="checkbox"/>	<input type="checkbox"/>	6-90
2	Custom parameters – 2					<input type="checkbox"/>	<input type="checkbox"/>	<input type="checkbox"/>	<input type="checkbox"/>	6-90
3	Custom parameters – 3					<input type="checkbox"/>	<input type="checkbox"/>	<input type="checkbox"/>	<input type="checkbox"/>	6-90
4	Custom parameters – 4					<input type="checkbox"/>	<input type="checkbox"/>	<input type="checkbox"/>	<input type="checkbox"/>	6-90
5	Custom parameters – 5					<input type="checkbox"/>	<input type="checkbox"/>	<input type="checkbox"/>	<input type="checkbox"/>	6-90
6	Custom parameters – 6					<input type="checkbox"/>	<input type="checkbox"/>	<input type="checkbox"/>	<input type="checkbox"/>	6-90
7	Custom parameters – 7					<input type="checkbox"/>	<input type="checkbox"/>	<input type="checkbox"/>	<input type="checkbox"/>	6-90
A05 – Parameter B and C indicatory skip										
0	Parameter B and C extended setting	1.	2.	2.	= 1: Display, = 2: Skip	<input type="checkbox"/>	<input type="checkbox"/>	<input type="checkbox"/>	<input type="checkbox"/>	6-90
1	Parameter B and C software option function	1.	2.	2.	= 1: Display, = 2: Skip	<input type="checkbox"/>	<input type="checkbox"/>	<input type="checkbox"/>	<input type="checkbox"/>	6-90
2	Parameter B and C hardware option function	1.	2.	2.	= 1: Display, = 2: Skip	<input type="checkbox"/>	<input type="checkbox"/>	<input type="checkbox"/>	<input type="checkbox"/>	6-90
A10 – ASR control constant 1										
0	ASR response	1.0	300.0	10.0 (rad/s)	The required ASR response radian frequency is set.	<input type="checkbox"/>	<input type="checkbox"/>	<input type="checkbox"/>	<input type="checkbox"/>	6-90
1	ASR machine time constant – 1	10.	20000.	1000 (ms)	The time to accelerate the motor and load's torque inertia to the base speed at the rated torque is set.	<input type="checkbox"/>	<input type="checkbox"/>	<input type="checkbox"/>	<input type="checkbox"/>	6-91
2	ASR integral time constant compensation coefficient	20.	500.	100. (%)	The compensation coefficient applied on the integral time constant of the speed regulator (ASR) is set.	<input type="checkbox"/>	<input type="checkbox"/>	<input type="checkbox"/>	<input type="checkbox"/>	6-91
3	ASR drive torque limiter	0.1	300.0	100.0 (%)	The limit values for the ASR drive side and regenerative side are set.	<input type="checkbox"/>	<input type="checkbox"/>	<input type="checkbox"/>	<input type="checkbox"/>	6-91
4	ASR regenerative torque limiter	0.1	300.0	100.0 (%)		<input type="checkbox"/>	<input type="checkbox"/>	<input type="checkbox"/>	<input type="checkbox"/>	6-91
5	ASR emergency stop regenerative torque limiter	0.1	300.0	100.0 (%)	The ASR regenerative side limit value applied during the emergency stop mode is set.	<input type="checkbox"/>	<input type="checkbox"/>	<input type="checkbox"/>	<input type="checkbox"/>	6-91
A11 – ACR control constant										
0	ACR response	100.	6000.	1000. (rad/s)	The ACR gain and time constant are set. This will affect the current response. If the gain is too low or too high, the current will become unstable, and the over current protection will function. Normally adjust the response between 500 and 1000, and the time constant between 5 and 20ms.	<input type="checkbox"/>	<input type="checkbox"/>	<input type="checkbox"/>	<input type="checkbox"/>	6-91
1	ACR time constant	0.1	300.0	20.0 (ms)		<input type="checkbox"/>	<input type="checkbox"/>	<input type="checkbox"/>	<input type="checkbox"/>	6-91
2	ACR drive torque limiter	0.1	300.0	100.0 (%)	The ACR drive side and regenerative side limit values are set.	<input type="checkbox"/>	<input type="checkbox"/>	<input type="checkbox"/>	<input type="checkbox"/>	6-91
3	ACR regenerative torque limiter	0.1	300.0	100.0 (%)		<input type="checkbox"/>	<input type="checkbox"/>	<input type="checkbox"/>	<input type="checkbox"/>	6-91
A20 – ACR control constant (PM)										
0	ACR response (PM)	100.	6000.	1500. (rad/s)	The ACR gain and time constant are set. This will affect the current response. If the gain is too low or too high, the current will become unstable, and the over current protection will function. Normally adjust the response between 500 and 2000, and the time constant between 5 and 20ms.	<input type="checkbox"/>	<input type="checkbox"/>	<input type="checkbox"/>	<input type="checkbox"/>	6-91
1	ACR time constant (PM)	0.1	300.0	10.0 (ms)		<input type="checkbox"/>	<input type="checkbox"/>	<input type="checkbox"/>	<input type="checkbox"/>	6-91
2	d axis current command cushion time (PM)	0.1	100.0	2.0 (ms/l1)	This is the cushion setting to prevent instability caused by overshooting, etc., when the current command changes suddenly.	<input type="checkbox"/>	<input type="checkbox"/>	<input type="checkbox"/>	<input type="checkbox"/>	6-91
3	q axis current command cushion time (PM)	0.1	100.0	2.0 (ms/l1)	Set at how many ms to change the current command value equivalent to the motor rated current. Normally, a value 5ms or more is set.	<input type="checkbox"/>	<input type="checkbox"/>	<input type="checkbox"/>	<input type="checkbox"/>	6-91

6. Control Functions and Parameter Settings

6-3 Block-B parameters

The Block-B parameters are divided into the basic functions, extended functions and software option functions.

V/f : Indicates parameters that apply for V/f control (constant torque, variable torque) (C30-0: f0 = 1).

VEC : Indicates parameters that apply for IM speed sensor-less vector control and IM speed vector control with sensor (C30-0: f0 = 2, 3).

PM : Indicates parameters that apply for control mode with PM motor sensor (C30-0: f0 = 4).

RWE : Displays the parameters that can be changed during operation.

Reference page: The number of the page providing detailed explanations is indicated.

Block-B parameters list

No.	Parameter	Min.	Max.	Default (Unit)	Function	Application				Ref. page																																															
						V/f	VEC	PM	RWE																																																
B00 – Output rating (V/f control)																																																									
0	Rated input voltage setting (V/f control)	1.	7.	7.	Select the rated input voltage from the following table.	<input type="radio"/>				6-92																																															
					<div style="display: flex; justify-content: space-around;"> <div style="text-align: center;"> Small size (Note 1) <table border="1" style="margin: auto;"> <thead> <tr> <th>Value</th> <th>200V system</th> <th>400V system</th> </tr> </thead> <tbody> <tr><td>1</td><td>200V</td><td>380V</td></tr> <tr><td>2</td><td>200V</td><td>400V</td></tr> <tr><td>3</td><td>220V</td><td>415V</td></tr> <tr><td>4</td><td>220V</td><td>440V</td></tr> <tr><td>5</td><td>230V</td><td>460V</td></tr> <tr><td>6</td><td>240V</td><td>480V</td></tr> <tr><td>7</td><td>230V</td><td>400V</td></tr> </tbody> </table> </div> <div style="text-align: center;"> Large size (Note 2) <table border="1" style="margin: auto;"> <thead> <tr> <th>Value</th> <th>200V system</th> <th>400V system</th> </tr> </thead> <tbody> <tr><td>1</td><td>200V</td><td>380V</td></tr> <tr><td>2</td><td>200V</td><td>400V</td></tr> <tr><td>3</td><td>220V</td><td>415V</td></tr> <tr><td>4</td><td>220V</td><td>440V</td></tr> <tr><td>5</td><td>230V</td><td>460V</td></tr> <tr><td>6</td><td>240V</td><td>480V</td></tr> <tr><td>7</td><td>230V</td><td>400V</td></tr> </tbody> </table> </div> </div>	Value	200V system	400V system	1	200V	380V	2	200V	400V	3	220V	415V	4	220V	440V	5	230V	460V	6	240V	480V	7	230V	400V	Value	200V system	400V system	1	200V	380V	2	200V	400V	3	220V	415V	4	220V	440V	5	230V	460V	6	240V	480V	7	230V	400V				
Value	200V system	400V system																																																							
1	200V	380V																																																							
2	200V	400V																																																							
3	220V	415V																																																							
4	220V	440V																																																							
5	230V	460V																																																							
6	240V	480V																																																							
7	230V	400V																																																							
Value	200V system	400V system																																																							
1	200V	380V																																																							
2	200V	400V																																																							
3	220V	415V																																																							
4	220V	440V																																																							
5	230V	460V																																																							
6	240V	480V																																																							
7	230V	400V																																																							
1	Max./base frequency simple setting (V/f control)	0.	9.	1.	Select the output frequency rating from the combination below.	<input type="radio"/>				6-92																																															
					<table border="1" style="margin: auto;"> <thead> <tr> <th>Value</th> <th>Ftrq [Hz]</th> <th>Fmax [Hz]</th> <th>Value</th> <th>Ftrq [Hz]</th> <th>Fmax [Hz]</th> </tr> </thead> <tbody> <tr> <td>0</td> <td colspan="2">Free setting on B00-4 and B00-5</td> <td>5</td> <td>50</td> <td>100</td> </tr> <tr> <td>1</td> <td>50</td> <td>50</td> <td>6</td> <td>60</td> <td>70</td> </tr> <tr> <td>2</td> <td>60</td> <td>60</td> <td>7</td> <td>60</td> <td>80</td> </tr> <tr> <td>3</td> <td>50</td> <td>60</td> <td>8</td> <td>60</td> <td>90</td> </tr> <tr> <td>4</td> <td>50</td> <td>75</td> <td>9</td> <td>60</td> <td>120</td> </tr> </tbody> </table>	Value	Ftrq [Hz]	Fmax [Hz]	Value	Ftrq [Hz]	Fmax [Hz]	0	Free setting on B00-4 and B00-5		5	50	100	1	50	50	6	60	70	2	60	60	7	60	80	3	50	60	8	60	90	4	50	75	9	60	120																
Value	Ftrq [Hz]	Fmax [Hz]	Value	Ftrq [Hz]	Fmax [Hz]																																																				
0	Free setting on B00-4 and B00-5		5	50	100																																																				
1	50	50	6	60	70																																																				
2	60	60	7	60	80																																																				
3	50	60	8	60	90																																																				
4	50	75	9	60	120																																																				
2	Motor rated output (V/f control)	0.10	750.00	Inverter rating (kW)	The motor rated output at the base frequency is set.	<input type="radio"/>				6-92																																															
3	Motor rated voltage (V/f control)	39.	480.	230. or 400. (V)	DC-AVR does not operate when set to 39. The input voltage equals the output voltage at the base frequency. DC-AVR operates so that the set voltage is attained at the base frequency when not set to 39. When the rated input voltage setting (B00-0) is changed, this data is also changed to the rated input voltage value. This cannot be set above the rated input voltage.	<input type="radio"/>				6-93																																															
4	Max. frequency (Fmax) (V/f control)	Fbase or 3.00	Fbase *7 or 440.00	50.00 (Hz)	When "B00-1" is a value other than 0, this will be rewritten with the data set in the simple setting.	<input type="radio"/>				6-93																																															
5	Base frequency (Fbase) (V/f control)	Fmax/7 or 1.00	Fmax or 440.00	50.00 (Hz)		<input type="radio"/>				6-93																																															
6	Motor rated current (V/f control)	Inverter rating × 0.3	Inverter rating	Inverter rating (A)	This is the reference value for the overcurrent limit, OLT, current % display, analog input and output.	<input type="radio"/>				6-93																																															

Note 1) Small size: 0P7L to 045L, 0P7H to 055H

Note 2) Large size: 055L to 090L, 075H to 475H

6. Control Functions and Parameter Settings

Block-B parameters list

No.	Parameter	Min.	Max.	Default (Unit)	Function	Application				Ref. page
						V/f	VEC	PM	RWE	
B00 – Output rating (V/f control)										
7	Carrier frequency (Small size) (V/f control)	1.0	21.0	17.0	The noise can be lowered by changing the PWM carrier frequency and control method, and changing the sound of the magnetic noise generated from the motor. This can be changed while running. 1.0 to 15.0: Monotone sound method (Carrier frequency: 1.0 to 15.0kHz) 15.1 to 18.0: Soft sound method 1 (Basic carrier frequency: 2.1 to 5.0kHz) 18.1 to 21.0: Soft sound method 2 (Basic carrier frequency: 2.1 to 5.0kHz)	○			○	6-94
7	Carrier frequency (Large size) (V/f control)	1.0	14.0	10.0	1.0 to 8.0: Monotone sound method (Carrier frequency: 1.0 to 8.0kHz) 8.1 to 11.0: Soft sound method 1 (Basic carrier frequency: 2.1 to 5.0kHz) 11.1 to 14.0: Soft sound method 2 (Basic carrier frequency: 2.1 to 5.0kHz)	○			○	6-94
B01 – Output rating (Vector control)										
0	Rated input voltage setting (Vector control)	1.	7.	7.	Select the rated input voltage from the following table.	○	○			6-92
		When this data is changed, the output voltage data will be changed to the same value.			Small size (Note 1)		Large size (Note 2)			
					Value	200V system	400V system	Value	200V system	400V system
					1	200V	380V	1	200V	380V
					2	200V	400V	2	200V	400V
					3	220V	415V	3	220V	415V
					4	220V	440V	4	220V	440V
					5	230V	460V	5	230V	460V
					6	240V	480V	6	240V	480V
					7	230V	400V	7	230V	400V
1	Motor rated output (Vector control)	0.10	750.00	Inverter rating (KW)	The motor's rated output at the base speed is set.	○	○			6-92
2	No. of motor poles (Vector control)	2.	32.	4.	Set the number of poles indicated on the motor nameplate.	○	○			6-92
3	Motor rated voltage (Vector control)	40.	480.	230. or 400. (V)	DC-AVR functions to attain the set voltage at the base frequency. If the rated input voltage setting (B01-0) is changed, this value is also changed to the rated input voltage value. This cannot be set higher than the rated input voltage.	○	○			6-93
4	Max. speed (Nmax) (Vector control)	150.	9999.	1800. (min ⁻¹)	The max. motor speed is set. Set a value that is 4-times or less of the base speed. In the case of PM motor control, set a value 1.5 times or less of the base speed. The maximum value is determined by the number of motor poles. The speed is limited where the synchronous frequency is 180Hz (210Hz at PM motor control).	○	○			6-93
5	Base speed (Nbase) (Vector control)	150.	Max. speed	1800. (min ⁻¹)	The motor base speed is set. When higher than this speed, the flux control during vector control will be weakened.	○	○			6-93
6	Motor rated current (Vector control)	Inverter rating × 0.3	Inverter rating	Inverter rating (A)	The motor current during full load at the base speed is set.	○	○			6-93

Note 1) Small size: 0P7L to 045L, 0P7H to 055H

Note 2) Large size: 055L to 090L, 075H to 475H

6. Control Functions and Parameter Settings

Block-B parameters list

No.	Parameter	Min.	Max.	Default (Unit)	Function	Application				Ref. page
						V/f	VEC	PM	RWE	
B01 – Output rating (Vector control)										
7	Carrier frequency (Small size) (Vector control)	1.0	21.0	17.0	The noise can be lowered by changing the PWM carrier frequency and control method, and changing the tone of the magnetic noise generated from the motor. This can be changed while running. 1.0 to 15.0: Monotone sound method (Carrier frequency: 1.0 to 15.0kHz) 15.1 to 18.0: Soft sound method 1 (Basic carrier frequency: 2.1 to 5.0kHz) 18.1 to 21.0: Soft sound method 2 (Basic carrier frequency: 2.1 to 5.0kHz)		<input type="radio"/>	<input type="radio"/>	<input type="radio"/>	6-94
7	Carrier frequency (Large size) (Vector control)	1.0	14.0	10.0	1.0 to 8.0: Monotone sound method (Carrier frequency: 1.0 to 8.0kHz) 8.1 to 11.0: Soft sound method 1 (Basic carrier frequency: 2.1 to 5.0kHz) 11.1 to 14.0: Soft sound method 2 (Basic carrier frequency: 2.1 to 5.0kHz)		<input type="radio"/>	<input type="radio"/>	<input type="radio"/>	6-94
8	No. of encoder pulses (Vector control)	30.	10000.	1000. (P/R)	The number of pulses per rotation of the encoder in use is set.		<input type="radio"/>	<input type="radio"/>		
9	No-load output voltage (Vector control)	20.	500.	160. (V)	The motor terminal voltage during no-load at the base speed is set.		<input type="radio"/>	<input type="radio"/>		
B02 – Motor circuit constant										
0	R1: Primary resistance (IM: Mantissa section)	0.010	90999	Inverter rating (mΩ)	The motor circuit constant is set. This combination means below $R2' = 1.000 \times 10^0$ [mΩ]	<input type="radio"/>	<input type="radio"/>		<input type="radio"/>	6-95
1	R1: Primary resistance (IM: Exponent section)	-3	4	Inverter rating		<input type="radio"/>	<input type="radio"/>			6-95
2	R2': Secondary resistance (IM : Mantissa section)	0.010	90999	1.000 (mΩ)		<input type="radio"/>		<input type="radio"/>		6-95
3	R2': Secondary resistance (IM: Exponent section)	-3	4	0.		<input type="radio"/>				6-95
4	Lσ: Leakage inductance (IM: Mantissa section)	0.100	9.999	1.000 (mH)		<input type="radio"/>		<input type="radio"/>		6-95
5	Lσ: Leakage inductance (IM: Exponent section)	-3	4	0.		<input type="radio"/>				6-95
6	M': Excitation inductance (IM: Mantissa section)	0.100	90999	1.000 (mH)		<input type="radio"/>		<input type="radio"/>		6-95
7	M': Excitation inductance (IM: Exponent section)	-3	4	0.		<input type="radio"/>				6-95
8	Rm: Iron loss resistance (IM: Mantissa section)	0.100	90999	1.000 (mΩ)		<input type="radio"/>		<input type="radio"/>		6-95
9	Rm: Iron loss resistance (IM: Exponent section)	-3	5	0.	<input type="radio"/>				6-95	

6. Control Functions and Parameter Settings

Block-B parameters list

No.	Parameter	Min.	Max.	Default (Unit)	Function	Application				Ref. page
						V/f	VEC	PM	RWE	
B03 – Motor circuit constant (PM)										
0	R1: PM motor primary resistance (Mantissa section)	0.001	9.999	1.000 (mΩ)	This combination means below $R1 = 1.000 \times 10^0$ [mΩ]			<input type="radio"/>	<input type="radio"/>	6-95
1	R1: PM motor secondary resistance (Exponent section)	-1.	4.	0.				<input type="radio"/>	<input type="radio"/>	6-95
2	Ld: PM motor d axis inductance (Mantissa section)	0.001	9.999	1.000 (mH)	This combination means below $Ld = 1.000 \times 10^0$ [mH]			<input type="radio"/>	<input type="radio"/>	6-95
3	Lq: PM motor q axis inductance (Mantissa section)	0.001	9.999	1.000 (mH)				<input type="radio"/>	<input type="radio"/>	6-95
4	Ld, Lq: PM motor inductance (Exponent section)	-1.	4.	0.				<input type="radio"/>	<input type="radio"/>	6-95
5	Rated torque electric current (PM)	20.0	200.0	100.0 (%/11M)	The torque current (q axis current) element required to generate the rated torque at the base speed is set as a ratio in respect to the rated current.			<input type="radio"/>		6-95
B05 – Frequency skip										
0	Skip frequency - 1	0.10	440.00	0.10 (Hz)	The set frequency avoids the jump width, during the jump frequency as a center point.	<input type="radio"/>			<input type="radio"/>	6-96
1	Skip band - 1	0.00	10.00	0.00 (Hz)		<input type="radio"/>			<input type="radio"/>	6-96
2	Skip frequency - 2	0.10	440.00	0.10 (Hz)		<input type="radio"/>			<input type="radio"/>	6-96
3	Skip band - 2	0.00	10.00	0.00 (Hz)		<input type="radio"/>			<input type="radio"/>	6-96
4	Skip frequency - 3	0.10	440.00	0.10 (Hz)		<input type="radio"/>			<input type="radio"/>	6-96
5	Skip band - 3	0.00	10.00	0.00 (Hz)		<input type="radio"/>			<input type="radio"/>	6-96

6. Control Functions and Parameter Settings

Block-B parameters list

No.	Parameter	Min.	Max.	Default (Unit)	Function	Application				Ref. page
						V/f	VEC	PM	RWE	
B06 – Gearing comparative setting										
0	Analog speed setting-1: Coefficient	-10.000	10.000	1.000	The coefficient and panel bias value for sequential ratio operation is set with the analog speed setting selected with C07-0: Speed setting 1.	<input type="radio"/>	<input type="radio"/>	<input type="radio"/>	<input type="radio"/>	6-97
1	Analog speed setting-1: Bias (V/f)	-fmax*5 or -440.00	fmax*5 or 440.00	0.00 (Hz)		<input type="radio"/>			<input type="radio"/>	6-97
2	Analog speed setting-1: Bias (Vector & PM)	-Nmax* 5 or -9999.	Nmax*5 or 9999.	0. (min ⁻¹)			<input type="radio"/>	<input type="radio"/>	<input type="radio"/>	6-97
3	Analog speed setting-2: Coefficient	-10.000	10.000	1.000	The coefficient and panel bias value for sequential ratio operation is set with the analog speed setting selected with C07-1: Speed setting 2.	<input type="radio"/>	<input type="radio"/>	<input type="radio"/>	<input type="radio"/>	6-97
4	Analog speed setting-2: Bias (V/f)	-fmax*5 or -440.00	fmax*5 or 440.00	0.00 (Hz)		<input type="radio"/>			<input type="radio"/>	6-97
5	Analog speed setting-2: Bias (Vector & PM)	-Nmax* 5 or -9999.	Nmax*5 or 9999.	0. (min ⁻¹)			<input type="radio"/>	<input type="radio"/>	<input type="radio"/>	6-97
6	Analog speed setting-3: Coefficient	-10.000	10.000	1.000	The coefficient and panel bias value for sequential ratio operation is set with the analog speed setting selected with C07-2: Speed setting 3.	<input type="radio"/>	<input type="radio"/>	<input type="radio"/>	<input type="radio"/>	6-97
7	Analog speed setting-3: Bias (V/f)	-fmax*5 or -440.00	fmax*5 or 440.00	0.00 (Hz)		<input type="radio"/>			<input type="radio"/>	6-97
8	Analog speed setting-3: Bias (Vector & PM)	-Nmax* 5 or -9999.	Nmax*5 or 9999.	0. (min ⁻¹)			<input type="radio"/>	<input type="radio"/>	<input type="radio"/>	6-97
9	Serial speed setting: Coefficient	-10.000	10.000	1.000	The coefficient and panel bias value for sequential ratio operation are set for when serial speed setting is valid.	<input type="radio"/>	<input type="radio"/>	<input type="radio"/>	<input type="radio"/>	6-97
A	Serial speed setting: Bias (V/f)	-fmax*5 or -440.00	fmax*5 or 440.00	0.00 (Hz)		<input type="radio"/>			<input type="radio"/>	6-97
B	Serial speed setting: Bias (Vector & PM)	-Nmax* 5 or -9999.	Nmax*5 or 9999.	0. (min ⁻¹)			<input type="radio"/>	<input type="radio"/>	<input type="radio"/>	6-97
C	Pulse train input speed setting: Coefficient	-10.000	10.000	1.000	The coefficient and panel bias value for sequential ratio operation are set for when pulse train input speed setting is valid.	<input type="radio"/>	<input type="radio"/>	<input type="radio"/>	<input type="radio"/>	6-97
D	Pulse train input speed setting: Bias (V/f)	-fmax*5 or -440.00	fmax*5 or 440.00	0.00 (Hz)		<input type="radio"/>			<input type="radio"/>	6-97
E	Pulse train input speed setting: Bias (Vector & PM)	-Nmax* 5 or -9999.	Nmax*5 or 9999.	0. (min ⁻¹)			<input type="radio"/>	<input type="radio"/>	<input type="radio"/>	6-97
B07 – Upper/Lower limit setting										
0	Upper limit (V/f, main)	-440.00	440.00	440.00 (Hz)	The upper limit is larger than the lower limit.	<input type="radio"/>			<input type="radio"/>	6-98
1	Lower limit (V/f, main)	-440.00	440.00	0.10 (Hz)		<input type="radio"/>			<input type="radio"/>	6-98
2	Upper limit (Vector&PM)	-9999.	9999.	7200. (min ⁻¹)	The upper limit is larger than the lower limit.		<input type="radio"/>	<input type="radio"/>	<input type="radio"/>	6-98
3	Lower limit (Vector&PM)	-9999.	9999.	-7200. (min ⁻¹)			<input type="radio"/>	<input type="radio"/>	<input type="radio"/>	6-98
B10 – Acceleration/deceleration time setting										
0	Acceleration time - 2 setting	0.1	6000.0	10.0 (s)	The acceleration/deceleration ramp time valid when the sequence input ramp 2 selection is ON (CSEL=ON) is set. Set a time between 0 and the max. frequency or max. speed.	<input type="radio"/>	<input type="radio"/>	<input type="radio"/>	<input type="radio"/>	6-98
1	Deceleration time - 2 setting	0.1	6000.0	20.0 (s)		The unit can be changed to ×0.1s, ×10s with the time unit setting (B10-5).	<input type="radio"/>	<input type="radio"/>	<input type="radio"/>	<input type="radio"/>
2	Acceleration time for jogging setting	0.1	6000.0	5.0 (s)	The acceleration/deceleration time value when the JOG sequence (F JOG, R JOG) is valid is set. Set a time between 0 and the max. frequency or max. speed.	<input type="radio"/>	<input type="radio"/>	<input type="radio"/>	<input type="radio"/>	6-98
3	Deceleration time for jogging setting	0.1	6000.0	5.0 (s)		The unit can be changed to ×0.1s, ×10s with the time unit setting (B10-5).	<input type="radio"/>	<input type="radio"/>	<input type="radio"/>	<input type="radio"/>

6. Control Functions and Parameter Settings

Block-B parameters list

No.	Parameter	Min.	Max.	Default (Unit)	Function	Application				Ref. page																																																																																																																																		
						V/f	VEC	PM	RWE																																																																																																																																			
B10 – Acceleration/deceleration time setting																																																																																																																																												
4	S-shape characteristics (Ts) acceleration and deceleration time setting	0.0	5.0	0.0 (s)	Set to 1/2 or less of the ramp time. S-shape pattern is possible by setting this parameter.	<input type="radio"/>	<input type="radio"/>	<input type="radio"/>	<input type="radio"/>	6-99																																																																																																																																		
5	Acceleration and deceleration cushion time unit setting	1.	3.	1.	=1:(Standard) =2: ×0.1 =3: ×10 The acceleration/deceleration ramp time setting unit can be changed by setting an acceleration/deceleration ramp time with a wider range. This parameter will affect all acceleration/ deceleration ramp time parameters.	<input type="radio"/>	<input type="radio"/>	<input type="radio"/>		6-99																																																																																																																																		
6	S-shape ramp pass function setting	1.	3.	1.	=1: OFF =2: For program 0 =3: For RUN-OFF	<input type="radio"/>	<input type="radio"/>	<input type="radio"/>		6-99																																																																																																																																		
B11 – Program frequency (speed) setting																																																																																																																																												
0	Program frequency (speed) - 0 setting	0.00	100.00	10.00 (%)	Select as follows with S0, S1, S2, S3 and SE.	<input type="radio"/>	<input type="radio"/>	<input type="radio"/>	<input type="radio"/>	6-100																																																																																																																																		
1	Program frequency (speed) - 1 setting	0.00	100.00	10.00 (%)	<p>(1) For binary mode (B11-8=1)</p> <table border="1" style="margin-left: 20px;"> <thead> <tr> <th colspan="5">Sequence command</th> <th rowspan="2">Selected frequency</th> </tr> <tr> <th>SE</th> <th>S3</th> <th>S2</th> <th>S1</th> <th>S0</th> </tr> </thead> <tbody> <tr> <td></td> <td></td> <td>OFF</td> <td>OFF</td> <td>OFF</td> <td>B11-0</td> </tr> <tr> <td></td> <td></td> <td>OFF</td> <td>OFF</td> <td>ON</td> <td>B11-1</td> </tr> <tr> <td></td> <td></td> <td>OFF</td> <td>ON</td> <td>OFF</td> <td>B11-2</td> </tr> <tr> <td></td> <td></td> <td>OFF</td> <td>ON</td> <td>ON</td> <td>B11-3</td> </tr> <tr> <td></td> <td></td> <td>ON</td> <td>OFF</td> <td>OFF</td> <td>B11-4</td> </tr> <tr> <td></td> <td></td> <td>ON</td> <td>OFF</td> <td>ON</td> <td>B11-5</td> </tr> <tr> <td></td> <td></td> <td>ON</td> <td>ON</td> <td>OFF</td> <td>B11-6</td> </tr> <tr> <td></td> <td></td> <td>ON</td> <td>ON</td> <td>ON</td> <td>B11-7</td> </tr> </tbody> </table> <p>* : SE and S3 are not used.</p> <p>(2) For direct select mode (B11-8=2)</p> <table border="1" style="margin-left: 20px;"> <thead> <tr> <th colspan="5">Sequence command</th> <th rowspan="2">Selected frequency</th> </tr> <tr> <th>SE</th> <th>S3</th> <th>S2</th> <th>S1</th> <th>S0</th> </tr> </thead> <tbody> <tr> <td>OFF</td> <td>OFF</td> <td>OFF</td> <td>OFF</td> <td>OFF</td> <td>Previous values</td> </tr> <tr> <td>OFF</td> <td>OFF</td> <td>OFF</td> <td>OFF</td> <td>ON</td> <td>B11-0</td> </tr> <tr> <td>OFF</td> <td>OFF</td> <td>OFF</td> <td>ON</td> <td>OFF</td> <td>B11-1</td> </tr> <tr> <td>OFF</td> <td>OFF</td> <td>ON</td> <td>OFF</td> <td>OFF</td> <td>B11-2</td> </tr> <tr> <td>OFF</td> <td>ON</td> <td>OFF</td> <td>OFF</td> <td>OFF</td> <td>B11-3</td> </tr> <tr> <td>ON</td> <td>OFF</td> <td>OFF</td> <td>OFF</td> <td>OFF</td> <td>Previous values</td> </tr> <tr> <td>ON</td> <td>OFF</td> <td>OFF</td> <td>OFF</td> <td>ON</td> <td>B11-4</td> </tr> <tr> <td>ON</td> <td>OFF</td> <td>OFF</td> <td>ON</td> <td>OFF</td> <td>B11-5</td> </tr> <tr> <td>ON</td> <td>OFF</td> <td>ON</td> <td>OFF</td> <td>OFF</td> <td>B11-6</td> </tr> <tr> <td>ON</td> <td>ON</td> <td>OFF</td> <td>OFF</td> <td>OFF</td> <td>B11-7</td> </tr> </tbody> </table> <p>When S0 to S3 are all OFF, or when two or more are set between S0 and S3, the previous values will be held. If there are no previous values because the power has been turned ON, etc., "0" will be set.</p>	Sequence command					Selected frequency	SE	S3	S2	S1	S0			OFF	OFF	OFF	B11-0			OFF	OFF	ON	B11-1			OFF	ON	OFF	B11-2			OFF	ON	ON	B11-3			ON	OFF	OFF	B11-4			ON	OFF	ON	B11-5			ON	ON	OFF	B11-6			ON	ON	ON	B11-7	Sequence command					Selected frequency	SE	S3	S2	S1	S0	OFF	OFF	OFF	OFF	OFF	Previous values	OFF	OFF	OFF	OFF	ON	B11-0	OFF	OFF	OFF	ON	OFF	B11-1	OFF	OFF	ON	OFF	OFF	B11-2	OFF	ON	OFF	OFF	OFF	B11-3	ON	OFF	OFF	OFF	OFF	Previous values	ON	OFF	OFF	OFF	ON	B11-4	ON	OFF	OFF	ON	OFF	B11-5	ON	OFF	ON	OFF	OFF	B11-6	ON	ON	OFF	OFF	OFF	B11-7	<input type="radio"/>	<input type="radio"/>	<input type="radio"/>	<input type="radio"/>	6-100
Sequence command						Selected frequency																																																																																																																																						
SE	S3	S2	S1	S0																																																																																																																																								
		OFF	OFF	OFF		B11-0																																																																																																																																						
		OFF	OFF	ON		B11-1																																																																																																																																						
		OFF	ON	OFF		B11-2																																																																																																																																						
		OFF	ON	ON		B11-3																																																																																																																																						
		ON	OFF	OFF	B11-4																																																																																																																																							
		ON	OFF	ON	B11-5																																																																																																																																							
		ON	ON	OFF	B11-6																																																																																																																																							
		ON	ON	ON	B11-7																																																																																																																																							
Sequence command					Selected frequency																																																																																																																																							
SE	S3	S2	S1	S0																																																																																																																																								
OFF	OFF	OFF	OFF	OFF	Previous values																																																																																																																																							
OFF	OFF	OFF	OFF	ON	B11-0																																																																																																																																							
OFF	OFF	OFF	ON	OFF	B11-1																																																																																																																																							
OFF	OFF	ON	OFF	OFF	B11-2																																																																																																																																							
OFF	ON	OFF	OFF	OFF	B11-3																																																																																																																																							
ON	OFF	OFF	OFF	OFF	Previous values																																																																																																																																							
ON	OFF	OFF	OFF	ON	B11-4																																																																																																																																							
ON	OFF	OFF	ON	OFF	B11-5																																																																																																																																							
ON	OFF	ON	OFF	OFF	B11-6																																																																																																																																							
ON	ON	OFF	OFF	OFF	B11-7																																																																																																																																							
2	Program frequency (speed) - 2 setting	0.00	100.00	10.00 (%)		<input type="radio"/>	<input type="radio"/>	<input type="radio"/>	<input type="radio"/>	6-100																																																																																																																																		
3	Program frequency (speed) - 3 setting	0.00	100.00	10.00 (%)		<input type="radio"/>	<input type="radio"/>	<input type="radio"/>	<input type="radio"/>	6-100																																																																																																																																		
4	Program frequency (speed) - 4 setting	0.00	100.00	10.00 (%)		<input type="radio"/>	<input type="radio"/>	<input type="radio"/>	<input type="radio"/>	6-100																																																																																																																																		
5	Program frequency (speed) - 5 setting	0.00	100.00	10.00 (%)		<input type="radio"/>	<input type="radio"/>	<input type="radio"/>	<input type="radio"/>	6-100																																																																																																																																		
6	Program frequency (speed) - 6 setting	0.00	100.00	10.00 (%)		<input type="radio"/>	<input type="radio"/>	<input type="radio"/>	<input type="radio"/>	6-100																																																																																																																																		
7	Program frequency (speed) - 7 setting	0.00	100.00	10.00 (%)		<input type="radio"/>	<input type="radio"/>	<input type="radio"/>	<input type="radio"/>	6-100																																																																																																																																		
8	Selection mode setting	1.	2.	1.	Select the program frequency setting (B11-0 to 7) and program ramp (B41, B42) selection mode. = 1: Binary mode = 2: Direct select mode	<input type="radio"/>	<input type="radio"/>	<input type="radio"/>		6-100																																																																																																																																		

6. Control Functions and Parameter Settings

Block-B parameters list

No.	Parameter	Min.	Max.	Default (Unit)	Function	Application				Ref. page
						V/F	VEC	PM	RWE	
B12 – Automatic braking on power failure setting (Main)										
0	Braking on power failure enable setting (Main)	1.	2.	1.	=1: C00-0, 1 compliant, =2: Decelerate stop at power failure	<input type="radio"/>	<input type="radio"/>	<input type="radio"/>	<input type="radio"/>	6-101
1	Power failure determination level setting (Main)	65.	90.	80. (%)	Sequence output: BPF turns ON when the DC voltage value is less than this level.	<input type="radio"/>	<input type="radio"/>	<input type="radio"/>	<input type="radio"/>	6-101
2	Deceleration ramp time-1 setting (Main)	0.1	6000.0	10.0 (s)	Motor decelerates from max. frequency value to 0Hz at the time set here.	<input type="radio"/>	<input type="radio"/>	<input type="radio"/>	<input type="radio"/>	6-101
3	Deceleration ramp time-2 setting (Main)	0.0	6000.0	10.0 (s)	Motor decelerates from max. frequency value to 0Hz at the time set here. When 0.0 is set, the motor decelerates at the deceleration ramp time -1.	<input type="radio"/>	<input type="radio"/>	<input type="radio"/>	<input type="radio"/>	6-101
4	Subtraction frequency setting (Main)	0.00	20.00	0.00 (Hz)	Subtraction is not executed when 0.00Hz is set. If the results of output frequency - subtraction frequency are 0 or less, the frequency is 0Hz and the brakes are applied.	<input type="radio"/>	<input type="radio"/>	<input type="radio"/>	<input type="radio"/>	6-101
5	Subtraction start frequency setting (Main)	0.00	Max frequency or 999.99	0.00 (Hz)	If the output frequency increases above this value, the motor decelerates from the results of output frequency - subtraction frequency. Subtraction is always executed when 999.99 is set.	<input type="radio"/>	<input type="radio"/>	<input type="radio"/>	<input type="radio"/>	6-101
6	Switching frequency setting (Main)	0.00	Max frequency	0.00 (Hz)	Changeover is not executed between 0.00 and the stopping frequency or less.	<input type="radio"/>	<input type="radio"/>	<input type="radio"/>	<input type="radio"/>	6-101
B13 – Local setting										
0	Torque setting	-300.0	300.0	0.0 (%)	This is the torque setting from the operation panel. Set C02-2 to 3 when using this setting.	<input type="radio"/>	<input type="radio"/>	<input type="radio"/>	<input type="radio"/>	6-102
1	Torque ratio 1 setting	0.001	5.000	1.000	This is the torque setting from the operation panel. Set C02-3 to 3 when using this setting.	<input type="radio"/>	<input type="radio"/>	<input type="radio"/>	<input type="radio"/>	6-102
2	Torque bias 1 setting	-300.0	300.0	0.0 (%)	This is the torque setting from the operation panel. Set C02-4 to 3 when using this setting.	<input type="radio"/>	<input type="radio"/>	<input type="radio"/>	<input type="radio"/>	6-102
3	Torque ratio 2 setting	-5.000	5.000	1.000	This is the torque setting from the operation panel. Set C02-5 to 3 when using this setting.	<input type="radio"/>	<input type="radio"/>	<input type="radio"/>	<input type="radio"/>	6-102
4	Double rating speed ratio setting	0.1	100.0	100.0 (%)	This sets the torque limiter reduction pattern changeover point. Set as a percentage in respect to the base speed.	<input type="radio"/>	<input type="radio"/>	<input type="radio"/>	<input type="radio"/>	6-102
5	Drooping setting	0.00	20.00	0.00 (%)	By adjusting this parameter, the torque-motor speed drooping characteristics can be achieved.	<input type="radio"/>	<input type="radio"/>	<input type="radio"/>	<input type="radio"/>	6-102
6	ASR gain compensation in constant power range	0.0	150.0	100.0 (%)	This sets the ASR gain compensation value at the max. speed. By adjusting this parameter, the ASR gain can be compensated in the constant power range. If ASR hunting occurs in the sensor-less vector control's constant output range, set a smaller value.	<input type="radio"/>	<input type="radio"/>	<input type="radio"/>	<input type="radio"/>	6-103
7	ACR gain compensation in constant power range	0.0	150.0	100.0 (%)	This sets the ACR gain compensation value at the max. speed. By adjusting this parameter, the ACR gain can be compensated in the constant power range.	<input type="radio"/>	<input type="radio"/>	<input type="radio"/>	<input type="radio"/>	6-103
8	Linear torque limit 1 (at 100% torque)	0.	450.	400. (%)	The linear torque limiter for operation of the PM motor in the weak magnetic field range is set.	<input type="radio"/>	<input type="radio"/>	<input type="radio"/>	<input type="radio"/>	6-103
9	Linear torque limit 2 (at 100% torque)	0.	450.	450. (%)	Refer to section 6-9-5 for details.	<input type="radio"/>	<input type="radio"/>	<input type="radio"/>	<input type="radio"/>	6-103

6. Control Functions and Parameter Settings

Block-B parameters list

No.	Parameter	Min.	Max.	Default (Unit)	Function	Application				Ref. page																							
						V/f	VEC	PM	RWE																								
B14 – ASR dead band setting																																	
0	ASR dead band setting	0.0	100.0	0.0 (%)	The non-sensitive range of the ASR input is set.		<input type="radio"/>	<input type="radio"/>	<input type="radio"/>	6-103																							
B15 – Machine time constant setting																																	
0	Machine time constant setting 2	10.	20000.	1000. (ms)	The time to accelerate the motor and load's torque inertia to the base speed at the rated torque is set. This is valid when the sequence command machine time constant changeover is ON (MCH = ON).		<input type="radio"/>	<input type="radio"/>	<input type="radio"/>	6-103																							
B16 – Automatic torque bias setting																																	
0	Automatic torque bias selection	0.	2.	0.	=0: Not used =1: Digital =2: Analog		<input type="radio"/>	<input type="radio"/>		6-104																							
1	Digital bias setting 0	-150.0	150.0	-100.0 (%)	These settings are selected according to the state of sequence input: S5, S6 and S7 (C05-0, 1, 2). <table border="1" style="margin: 10px auto; border-collapse: collapse;"> <thead> <tr> <th>S7</th> <th>S6</th> <th>S5</th> <th></th> </tr> </thead> <tbody> <tr> <td>0</td> <td>0</td> <td>0</td> <td>setting0</td> </tr> <tr> <td>0</td> <td>0</td> <td>1</td> <td>Setting1</td> </tr> <tr> <td>0</td> <td>1</td> <td>0</td> <td>Setting2</td> </tr> <tr> <td>0</td> <td>1</td> <td>1</td> <td>Setting3</td> </tr> <tr> <td>1</td> <td>x</td> <td>x</td> <td>Setting4</td> </tr> </tbody> </table>	S7	S6	S5		0	0	0	setting0	0	0	1	Setting1	0	1	0	Setting2	0	1	1	Setting3	1	x	x	Setting4		<input type="radio"/>	<input type="radio"/>	6-104
S7	S6	S5																															
0	0	0	setting0																														
0	0	1	Setting1																														
0	1	0	Setting2																														
0	1	1	Setting3																														
1	x	x	Setting4																														
2	Digital bias setting 1	-150.0	150.0	-50.0 (%)			<input type="radio"/>	<input type="radio"/>	6-104																								
3	Digital bias setting 2	-150.0	150.0	0.0 (%)			<input type="radio"/>	<input type="radio"/>	6-104																								
4	Digital bias setting 3	-150.0	150.0	50.0 (%)			<input type="radio"/>	<input type="radio"/>	6-104																								
5	Digital bias setting 4	-150.0	150.0	100.0 (%)			<input type="radio"/>	<input type="radio"/>	6-104																								
6	Bias direction selection	1.	2.	1.	Set the bias direction. =1: Clockwise drive direction =2: Counterclockwise drive direction		<input type="radio"/>	<input type="radio"/>		6-104																							
7	Torque bias start-up time	0.00	10.00	0.00 (sec)			<input type="radio"/>	<input type="radio"/>		6-104																							
8	Analog bias voltage 0	-100.0	100.0	0.0 (%)	Set the input voltage lower limit value.		<input type="radio"/>	<input type="radio"/>		6-104																							
9	Analog bias voltage 1	-100.0	100.0	50.0 (%)	Set the input voltage at the balance point.		<input type="radio"/>	<input type="radio"/>		6-104																							
A	Analog bias voltage 2	-100.0	100.0	100.0 (%)	Set the input voltage upper limit value.		<input type="radio"/>	<input type="radio"/>		6-104																							
B	Output bias torque 0	-150.0	150.0	-100.0 (%)	Set the bias torque at the input voltage lower limit value.		<input type="radio"/>	<input type="radio"/>		6-104																							
B17 – V/f middle point setting																																	
0	V/f middle point setting-Frequency 1	0.00	Max. frequency	0.00 (Hz)	The following rule applies to each frequency. $F_{max} \geq \text{frequency-5} \geq \text{frequency-4} \geq \text{frequency-3} \geq \text{frequency-2} \geq \text{frequency-1} \geq 0$ If the setting exceeds this rule, the excessive frequency will be set to the same value as the changed setting value. Set the frequency value to 0.00 when using 4 points or less. Note that there is no need to set 0.00 from frequency -1. If all frequency settings are set to 0.00, the voltage at the base frequency will be 100%, and the B17-A setting value V/f characteristics will be applied at the max. frequency value.		<input type="radio"/>			6-105																							
1	V/f middle point setting-Voltage 1	0.0	200.0	0.0 (%)				<input type="radio"/>			6-105																						
2	V/f middle point setting-Frequency 2	0.00	Max. frequency	0.00 (Hz)				<input type="radio"/>			6-105																						
3	V/f middle point setting-Voltage 2	0.0	200.0	0.0 (%)				<input type="radio"/>			6-105																						
4	V/f middle point setting-Frequency 3	0.00	Max. frequency	0.00 (Hz)				<input type="radio"/>			6-105																						
5	V/f middle point setting-Voltage 3	0.0	200.0	0.0 (%)				<input type="radio"/>			6-105																						
6	V/f middle point setting-Frequency 4	0.00	Max. frequency	0.00 (Hz)				<input type="radio"/>			6-105																						
7	V/f middle point setting-Voltage 4	0.0	200.0	0.0 (%)				<input type="radio"/>			6-105																						
8	V/f middle point setting-Frequency 5	0.00	Max. frequency	0.00 (Hz)				<input type="radio"/>			6-105																						
9	V/f middle point setting-Voltage 5	0.0	200.0	0.0 (%)				<input type="radio"/>			6-105																						
A	V/f middle point setting-Voltage Fmax	0.0	200.0	0.0 (%)				<input type="radio"/>			6-105																						
B	V/f middle point use selection	1.	2.	1.		=1: Function invalid =2: Function valid		<input type="radio"/>			6-105																						

6. Control Functions and Parameter Settings

Block-B parameters list

No.	Parameter	Min.	Max.	Default (Unit)	Function	Application				Ref. page
						V/f	VEC	PM	RWE	
B18 – Current limit										
0	Drive current limit	50.	300.	125. (%)	The default value is 155. when heavy-duty is set.	<input type="radio"/>	<input type="radio"/>	<input type="radio"/>	<input type="radio"/>	6-107
1	Regenerative current limit	5.	300.	10. (%)	Set to 10% when not using the DBR option.	<input type="radio"/>	<input type="radio"/>	<input type="radio"/>	<input type="radio"/>	6-108
2	Torque stabilization gain	0.00	4.00	1.00	The disturbance symptoms which occur if the current abnormally vibrates after motor operation is suppressed. Increase or decrease by 0.05 units if the motor vibrates.	<input type="radio"/>	<input type="radio"/>	<input type="radio"/>	<input type="radio"/>	6-108
3	Current limit function gain	0.00	2.00	0.25	Decrease if current hunting occurs.	<input type="radio"/>	<input type="radio"/>	<input type="radio"/>	<input type="radio"/>	6-107
4	Current stabilization gain	0.00	2.00	0.25		<input type="radio"/>	<input type="radio"/>	<input type="radio"/>	<input type="radio"/>	6-107
5	Current stall prevention gain	0.00	2.50	1.00	Decrease if current hunting occurs.	<input type="radio"/>	<input type="radio"/>	<input type="radio"/>	<input type="radio"/>	6-107
6	Stall prevention time constant	10.	1001.	100.	Increase if current hunting occurs. P control will be applied if 1001 is set.	<input type="radio"/>	<input type="radio"/>	<input type="radio"/>	<input type="radio"/>	6-107
7	Drive current limit level 2	50.	300.	200.0 (%)	When sequence input: OCLLV1 is ON, this parameter value is selected for the overcurrent limit. This function is not applied on the auxiliary drive.	<input type="radio"/>	<input type="radio"/>	<input type="radio"/>	<input type="radio"/>	6-107
8	Drive current limit level 3	50.	300.	250.0 (%)	When sequence input: OCLLV2 is ON, this parameter value is selected for the overcurrent limit. This function is not applied on the auxiliary drive.	<input type="radio"/>	<input type="radio"/>	<input type="radio"/>	<input type="radio"/>	6-107
B19 – Automatic tuning function										
0	Automatic tuning selection	0.	7.	0.	=1: Basic adjustment for V/f Control =2: Extended adjustment for V/f Control =3: Basic adjustment for Vector Control =4: Extended adjustment for Vector Control =5: Calculation of no load voltage for Vector Control =6: Encoder phase adjustment (PM) =7: Flux position estimation	<input type="radio"/>	<input type="radio"/>	<input type="radio"/>	<input type="radio"/>	6-108
1	Initial proportion compensation gain (Automatic tuning function)	0.	500.	100. (%)	When the motor with special circuit parameters is applied, the initial condition of automatic tuning is set. Change these value if auto tuning is completed incorrectly and try to auto tuning again. Set these values to increase or decrease with 50% step.	<input type="radio"/>	<input type="radio"/>	<input type="radio"/>	<input type="radio"/>	
2	Initial time constant compensation gain (Automatic tuning function)	0.	500.	100. (%)		<input type="radio"/>	<input type="radio"/>	<input type="radio"/>	<input type="radio"/>	

6. Control Functions and Parameter Settings

Block-B parameters list

No.	Parameter	Min.	Max.	Default (Unit)	Function	Application				Ref. page																																			
						V/f	VEC	PM	RWE																																				
B20 – Output rating (Auxiliary drive 0)																																													
0	Max./base frequency simple setting (Auxiliary drive 0)	0.	9.	1.	Select the output frequency rating from the combination below.	<input type="radio"/>	<input type="radio"/>	<input type="radio"/>	<input type="radio"/>	6-108																																			
					<table border="1" style="width: 100%; border-collapse: collapse;"> <thead> <tr> <th>Value</th> <th>Ftrq [Hz]</th> <th>Fmax [Hz]</th> </tr> </thead> <tbody> <tr> <td>0</td> <td>Free setting on B20-4, 5</td> <td></td> </tr> <tr> <td>1</td> <td>50</td> <td>50</td> </tr> <tr> <td>2</td> <td>60</td> <td>60</td> </tr> <tr> <td>3</td> <td>50</td> <td>60</td> </tr> <tr> <td>4</td> <td>50</td> <td>75</td> </tr> </tbody> </table> <table border="1" style="width: 100%; border-collapse: collapse;"> <thead> <tr> <th>Value</th> <th>Ftrq [Hz]</th> <th>Fmax [Hz]</th> </tr> </thead> <tbody> <tr> <td>5</td> <td>50</td> <td>100</td> </tr> <tr> <td>6</td> <td>60</td> <td>70</td> </tr> <tr> <td>7</td> <td>60</td> <td>80</td> </tr> <tr> <td>8</td> <td>60</td> <td>90</td> </tr> <tr> <td>9</td> <td>60</td> <td>120</td> </tr> </tbody> </table>	Value	Ftrq [Hz]	Fmax [Hz]	0	Free setting on B20-4, 5		1	50	50	2	60	60	3	50	60	4	50	75	Value	Ftrq [Hz]	Fmax [Hz]	5	50	100	6	60	70	7	60	80	8	60	90	9	60	120				
Value	Ftrq [Hz]	Fmax [Hz]																																											
0	Free setting on B20-4, 5																																												
1	50	50																																											
2	60	60																																											
3	50	60																																											
4	50	75																																											
Value	Ftrq [Hz]	Fmax [Hz]																																											
5	50	100																																											
6	60	70																																											
7	60	80																																											
8	60	90																																											
9	60	120																																											
1	Rated output voltage (Auxiliary drive 0)	39.	480.	230. or 400. (V)	DC-AVR will not function when 39 is set. The input voltage is the same as the output voltage at the base frequency. When a value other than 39 is set, the DC-AVR will function so that the set voltage is attained at the base frequency. When the rated input voltage setting (B00-0) is changed, this data is also changed to the rated input voltage value. This cannot be set above the rated input voltage.	<input type="radio"/>	<input type="radio"/>	<input type="radio"/>	<input type="radio"/>	6-108																																			
2	Max. frequency (Fmax_AU0) (Auxiliary drive 0)	Fbase_AU0 or 3.00	FBASE_AU0*7 or 440.00	50.00 (Hz)	When "B20-0" is a value other than 0, this will be rewritten with the data set in the simple setting.	<input type="radio"/>	<input type="radio"/>	<input type="radio"/>	<input type="radio"/>	6-108																																			
3	Base frequency (Fbase_AU0) (Auxiliary drive 0)	Fmax_AU0/7 or 1.00	Fmax_AU0 or 440.00	50.00 (Hz)		<input type="radio"/>	<input type="radio"/>	<input type="radio"/>	<input type="radio"/>	6-108																																			
4	Motor rated current (Auxiliary drive 0)	Inverter rating × 0.3	Inverter rating	Inverter rating (A)	This is the reference value for the overcurrent limit, OLT, current % display, analog input and output.	<input type="radio"/>	<input type="radio"/>	<input type="radio"/>	<input type="radio"/>	6-108																																			
5	Carrier frequency (Small size) (Auxiliary drive 0)	1.0	21.0	17.0	Refer to B00-7 for details on the settings.	<input type="radio"/>	<input type="radio"/>	<input type="radio"/>	<input type="radio"/>	6-108																																			
5	Carrier frequency (Large size) (Auxiliary drive 0)	1.0	14.0	10.0		<input type="radio"/>	<input type="radio"/>	<input type="radio"/>	<input type="radio"/>	6-108																																			
6	Start frequency (Auxiliary drive 0)	0.10	60.00	1.00 (Hz)	Operation starts from this frequency value when the motor starts.	<input type="radio"/>	<input type="radio"/>	<input type="radio"/>	<input type="radio"/>	6-108																																			
7	Stop frequency (Auxiliary drive 0)	0.10	60.00	1.00 (Hz)	The DC brakes are applied when the frequency value is less than this frequency value.	<input type="radio"/>	<input type="radio"/>	<input type="radio"/>	<input type="radio"/>	6-108																																			
8	Upper limit (Auxiliary drive 0)	-440.00	440.00	440.00 (Hz)	Make sure that the upper limit is greater than the lower limit.	<input type="radio"/>	<input type="radio"/>	<input type="radio"/>	<input type="radio"/>	6-108																																			
9	Lower limit (Auxiliary drive 0)	-440.00	440.00	0.10 (Hz)		<input type="radio"/>	<input type="radio"/>	<input type="radio"/>	<input type="radio"/>	6-108																																			
B21 – Frequency setting (Auxiliary drive 0)																																													
0	Local frequency setting (Auxiliary drive 0)	0.10	Fmax_AU0	10.00 (Hz)	This is the frequency set from the operation panel.	<input type="radio"/>	<input type="radio"/>	<input type="radio"/>	<input type="radio"/>	6-108																																			
1	Frequency setting for jogging (Auxiliary drive 0)	0.10	Fmax_AU0	5.00 (Hz)	This is the frequency setting for jogging.	<input type="radio"/>	<input type="radio"/>	<input type="radio"/>	<input type="radio"/>	6-108																																			
2	Acceleration time - 1 (Auxiliary drive 0)	0.1	6000.0	10.0 (s)	The unit can be changed to ×0.1s, ×10s with the time unit setting (B10-5).	<input type="radio"/>	<input type="radio"/>	<input type="radio"/>	<input type="radio"/>	6-108																																			
3	Deceleration time - 1 (Auxiliary drive 0)	0.1	6000.0	20.0 (s)	The time to reach the max. frequency or max. speed from 0 is set.	<input type="radio"/>	<input type="radio"/>	<input type="radio"/>	<input type="radio"/>	6-108																																			

6. Control Functions and Parameter Settings

Block-B parameters list

No.	Parameter	Min.	Max.	Default (Unit)	Function	Application				Ref. page
						V/f	VEC	PM	RWE	
B21 – Frequency setting (Auxiliary drive 0)										
4	Acceleration time - 2 (Auxiliary drive 0)	0.1	6000.0	10.0 (s)	This is the acceleration/deceleration ramp time setting made valid when the sequence command ramp 2 switch is ON (CSEL=ON). Set a time between 0 and the max. frequency or max. speed. The unit can be changed to ×0.1s, ×10s with the time unit setting (B10-5). The acceleration/deceleration ramp time value when the JOG sequence (F JOG, R JOG) is valid is set. Set a time between 0 and the max. frequency. The unit can be changed to ×0.1s, ×10s with the time unit setting (B10-5).	<input type="checkbox"/>	<input type="checkbox"/>	<input type="checkbox"/>	<input type="checkbox"/>	6-108
5	Deceleration time - 2 (Auxiliary drive 0)	0.1	6000.0	20.0 (s)		<input type="checkbox"/>	<input type="checkbox"/>	<input type="checkbox"/>	<input type="checkbox"/>	6-108
6	Acceleration time for jogging (Auxiliary drive 0)	0.1	6000.0	5.0 (s)		<input type="checkbox"/>	<input type="checkbox"/>	<input type="checkbox"/>	<input type="checkbox"/>	6-108
7	Deceleration time for jogging (Auxiliary drive 0)	0.1	6000.0	2.0 (s)		<input type="checkbox"/>	<input type="checkbox"/>	<input type="checkbox"/>	<input type="checkbox"/>	6-108
B22 – Torque boost, DC Brake, DC Brake setting, Overcurrent setting, Overload setting (Auxiliary drive 0)										
0	Manual torque boost setting (Auxiliary drive 0)	0.00	20.00	Inverter rating (%)	Set the boost voltage at 0Hz.	<input type="checkbox"/>	<input type="checkbox"/>	<input type="checkbox"/>	<input type="checkbox"/>	6-108
1	Square reduction torque setting (Auxiliary drive 0)	0.00	25.00	0.0 (%)	Set the reduced voltage at Base frequency/2.	<input type="checkbox"/>	<input type="checkbox"/>	<input type="checkbox"/>	<input type="checkbox"/>	6-108
2	DC braking voltage (Auxiliary drive 0)	0.01	20.00	Inverter rating (%)	When setting manually, monitor the output voltage and change the setting in increments of 1% or less.	<input type="checkbox"/>	<input type="checkbox"/>	<input type="checkbox"/>	<input type="checkbox"/>	6-108
3	DC braking time (Auxiliary drive 0)	0.0	20.0	2.0 (s)	Set the time to apply the DC brakes.	<input type="checkbox"/>	<input type="checkbox"/>	<input type="checkbox"/>	<input type="checkbox"/>	6-108
4	Over current limit (Auxiliary drive 0)	50.	300.	125. (%)	The default value is 155. when heavy-duty is set.	<input type="checkbox"/>	<input type="checkbox"/>	<input type="checkbox"/>	<input type="checkbox"/>	6-108
5	Regenerative current limit (Auxiliary drive 0)	5.	300.	10. (%)	Set to 10% when not using the DBR option.	<input type="checkbox"/>	<input type="checkbox"/>	<input type="checkbox"/>	<input type="checkbox"/>	6-108
6	Torque stabilization gain (Auxiliary drive 0)	0.00	4.00	1.00	Increase or decrease by 0.05 units if the motor vibrates.	<input type="checkbox"/>	<input type="checkbox"/>	<input type="checkbox"/>	<input type="checkbox"/>	6-108
7	Motor overload reference (Auxiliary drive 0)	50.0	105.0	100.0 (%)	When this data is changed, the B22-8, 9 data is limited to this value. Take care when decreasing and then increasing this value.	<input type="checkbox"/>	<input type="checkbox"/>	<input type="checkbox"/>	<input type="checkbox"/>	6-108
8	0Hz overload (Auxiliary drive 0)	20.0	105.0	100.0 (%)	The max. value is the B22-9 value.	<input type="checkbox"/>	<input type="checkbox"/>	<input type="checkbox"/>	<input type="checkbox"/>	6-108
9	0.7Base freq. overload (Auxiliary drive 0)	50.0	105.0	100.0 (%)	The min. value is the B22-8 value.	<input type="checkbox"/>	<input type="checkbox"/>	<input type="checkbox"/>	<input type="checkbox"/>	6-108
B23 – Braking on power failure setting (Auxiliary drive 0)										
0	Braking on power deceleration ramp time-1 (Auxiliary drive 0)	0.1	6000.0	10.0 (s)	Set the deceleration time from the maximum frequency value to 0Hz.	<input type="checkbox"/>	<input type="checkbox"/>	<input type="checkbox"/>	<input type="checkbox"/>	6-108
1	Braking on power deceleration ramp time-2 (Auxiliary drive 0)	0.0	6000.0	10.0 (s)	Set the deceleration time from the maximum frequency value to 0Hz. Deceleration is performed at deceleration ramp time-1 when 0.0.	<input type="checkbox"/>	<input type="checkbox"/>	<input type="checkbox"/>	<input type="checkbox"/>	6-108
2	Braking on power subtraction frequency (Auxiliary drive 0)	0.00	20.00	0.00 (Hz)	No subtraction made when 0.00Hz. 0Hz and brake engaged when the result of output frequency – subtraction frequency is 0 or less.	<input type="checkbox"/>	<input type="checkbox"/>	<input type="checkbox"/>	<input type="checkbox"/>	6-108
3	Braking on power subtraction start frequency (Auxiliary drive 0)	0.00	Fmax_AU0 or 999.99	0.00 (Hz)	If the output frequency is higher than this value, deceleration is performed from the result of output frequency – subtraction frequency. Subtraction is always performed when 999.9.	<input type="checkbox"/>	<input type="checkbox"/>	<input type="checkbox"/>	<input type="checkbox"/>	6-108
4	Braking on power switching frequency (Auxiliary drive 0)	0.00	Fmax_AU0	0.00 (Hz)	Switching is not performed when 0.00 to stoppage frequency or less.	<input type="checkbox"/>	<input type="checkbox"/>	<input type="checkbox"/>	<input type="checkbox"/>	6-108

6. Control Functions and Parameter Settings

Block-B parameters list

No.	Parameter	Min.	Max.	Default (Unit)	Function	Application				Ref. page
						Vf	VEC	PM	RWE	
B25 – Frequency setting (Auxiliary drive 1)										
4	Acceleration time - 2 (Auxiliary drive 1)	0.1	6000.0	10.0 (s)	This is the acceleration/deceleration ramp time setting made valid when the sequence command ramp 2 switch is ON (CSEL=ON). Set a time between 0 and the max. frequency or max. speed. The unit can be changed to ×0.1s, ×10s with the time unit setting (B10-5). The acceleration/deceleration ramp time value when the JOG sequence (F JOG, R JOG) is valid is set. Set a time between 0 and the max. frequency. The unit can be changed to ×0.1s, ×10s with the time unit setting (B10-5).	<input type="checkbox"/>	<input type="checkbox"/>	<input type="checkbox"/>	<input type="checkbox"/>	6-108
5	Deceleration time - 2 (Auxiliary drive 1)	0.1	6000.0	20.0 (s)		<input type="checkbox"/>	<input type="checkbox"/>	<input type="checkbox"/>	<input type="checkbox"/>	6-108
6	Acceleration time for jogging (Auxiliary drive 1)	0.1	6000.0	5.0 (s)		<input type="checkbox"/>	<input type="checkbox"/>	<input type="checkbox"/>	<input type="checkbox"/>	6-108
7	Deceleration time for jogging (Auxiliary drive 1)	0.1	6000.0	2.0 (s)		<input type="checkbox"/>	<input type="checkbox"/>	<input type="checkbox"/>	<input type="checkbox"/>	6-108
B26 – Torque boost, DC Brake, DC Brake setting, Overcurrent setting, Overload setting (Auxiliary drive 1)										
0	Manual torque boost setting (Auxiliary drive 1)	0.00	20.00	Inverter rating (%)	Set the boost voltage at 0Hz.	<input type="checkbox"/>	<input type="checkbox"/>	<input type="checkbox"/>	<input type="checkbox"/>	6-108
1	Square reduction torque setting (Auxiliary drive 1)	0.00	25.00	0.0 (%)	Set the reduced voltage at Base frequency/2.	<input type="checkbox"/>	<input type="checkbox"/>	<input type="checkbox"/>	<input type="checkbox"/>	6-108
2	DC braking voltage (Auxiliary drive 1)	0.01	20.00	Inverter rating (%)	When setting manually, monitor the output voltage and change the setting in increments of 1% or less.	<input type="checkbox"/>	<input type="checkbox"/>	<input type="checkbox"/>	<input type="checkbox"/>	6-108
3	DC braking time (Auxiliary drive 1)	0.0	20.0	2.0 (sec)	Set the time to apply the DC brakes.	<input type="checkbox"/>	<input type="checkbox"/>	<input type="checkbox"/>	<input type="checkbox"/>	6-108
4	Over current limit (Auxiliary drive 1)	50.	300.	125. (%)	The default value is 155. when heavy-duty is set.	<input type="checkbox"/>	<input type="checkbox"/>	<input type="checkbox"/>	<input type="checkbox"/>	6-108
5	Regenerative current limit (Auxiliary drive 1)	5.	300.	10. (%)	Set to 10% when not using the DBR option.	<input type="checkbox"/>	<input type="checkbox"/>	<input type="checkbox"/>	<input type="checkbox"/>	6-108
6	Torque stabilization gain (Auxiliary drive 1)	0.00	4.00	1.00	Increase or decrease by 0.05 units if the motor vibrates.	<input type="checkbox"/>	<input type="checkbox"/>	<input type="checkbox"/>	<input type="checkbox"/>	6-108
7	Motor overload reference (Auxiliary drive 1)	50.0	105.0	100.0 (%)	When this data is changed, the B26-8, 9 data is limited to this value. Take care when decreasing and then increasing this value.	<input type="checkbox"/>	<input type="checkbox"/>	<input type="checkbox"/>		6-108
8	0Hz overload (Auxiliary drive 1)	20.0	105.0	100.0 (%)	The max. value is the B26-9 value.	<input type="checkbox"/>	<input type="checkbox"/>	<input type="checkbox"/>		6-108
9	0.7Base freq. overload (Auxiliary drive 1)	50.0	105.0	100.0 (%)	The min. value is the B26-8 value.	<input type="checkbox"/>	<input type="checkbox"/>	<input type="checkbox"/>		6-108
B27 – Braking on power failure setting (Auxiliary drive 1)										
0	Braking on power deceleration ramp time-1 (Auxiliary drive 1)	0.1	6000.0	10.0 (s)	Set the deceleration time from the maximum frequency value to 0Hz.	<input type="checkbox"/>	<input type="checkbox"/>	<input type="checkbox"/>	<input type="checkbox"/>	6-108
1	Braking on power deceleration ramp time-2 (Auxiliary drive 1)	0.0	6000.0	10.0 (s)	Set the deceleration time from the maximum frequency value to 0Hz. Deceleration is performed at deceleration ramp time-1 when 0.0.	<input type="checkbox"/>	<input type="checkbox"/>	<input type="checkbox"/>	<input type="checkbox"/>	6-108
2	Braking on power subtraction frequency (Auxiliary drive 1)	0.00	20.00	0.00 (Hz)	No subtraction made when 0.00Hz. 0Hz and brake engaged when the result of output frequency – subtraction frequency is 0 or less.	<input type="checkbox"/>	<input type="checkbox"/>	<input type="checkbox"/>	<input type="checkbox"/>	6-108
3	Braking on power subtraction start frequency (Auxiliary drive 1)	0.00	Fmax_AU1 or 999.99	0.00 (Hz)	If the output frequency is higher than this value, deceleration is performed from the result of output frequency – subtraction frequency. Subtraction is always performed when 999.9.	<input type="checkbox"/>	<input type="checkbox"/>	<input type="checkbox"/>	<input type="checkbox"/>	6-108
4	Braking on power switching frequency (Auxiliary drive 1)	0.00	Fmax_AU1	0.00 (Hz)	Switching is not performed when 0.00 to stoppage frequency or less.	<input type="checkbox"/>	<input type="checkbox"/>	<input type="checkbox"/>	<input type="checkbox"/>	6-108

6. Control Functions and Parameter Settings

Block-B parameters list

No.	Parameter	Min.	Max.	Default (Unit)	Function	Application				Ref. page																																			
						Vf	VEC	PM	RWE																																				
B28 – Output rating (Auxiliary drive 2)																																													
0	Max./base frequency simple setting (Auxiliary drive 2)	0.	9.	1.	Select the output frequency rating from the combination below.	<input type="radio"/>	<input type="radio"/>	<input type="radio"/>	<input type="radio"/>	6-108																																			
					<table border="1" style="width: 100%; border-collapse: collapse;"> <thead> <tr> <th>Value</th> <th>Ftrq [Hz]</th> <th>Fmax [Hz]</th> </tr> </thead> <tbody> <tr> <td>0</td> <td colspan="2">Free setting on B28-4, 5</td> </tr> <tr> <td>1</td> <td>50</td> <td>50</td> </tr> <tr> <td>2</td> <td>60</td> <td>60</td> </tr> <tr> <td>3</td> <td>50</td> <td>60</td> </tr> <tr> <td>4</td> <td>50</td> <td>75</td> </tr> </tbody> </table> <table border="1" style="width: 100%; border-collapse: collapse;"> <thead> <tr> <th>Value</th> <th>Ftrq [Hz]</th> <th>Fmax [Hz]</th> </tr> </thead> <tbody> <tr> <td>5</td> <td>50</td> <td>100</td> </tr> <tr> <td>6</td> <td>60</td> <td>70</td> </tr> <tr> <td>7</td> <td>60</td> <td>80</td> </tr> <tr> <td>8</td> <td>60</td> <td>90</td> </tr> <tr> <td>9</td> <td>60</td> <td>120</td> </tr> </tbody> </table>	Value	Ftrq [Hz]	Fmax [Hz]	0	Free setting on B28-4, 5		1	50	50	2	60	60	3	50	60	4	50	75	Value	Ftrq [Hz]	Fmax [Hz]	5	50	100	6	60	70	7	60	80	8	60	90	9	60	120				
Value	Ftrq [Hz]	Fmax [Hz]																																											
0	Free setting on B28-4, 5																																												
1	50	50																																											
2	60	60																																											
3	50	60																																											
4	50	75																																											
Value	Ftrq [Hz]	Fmax [Hz]																																											
5	50	100																																											
6	60	70																																											
7	60	80																																											
8	60	90																																											
9	60	120																																											
1	Rated output voltage (Auxiliary drive 2)	39.	480.	230. or 400. (V)	DC-AVR will not function when 39 is set. The input voltage is the same as the output voltage at the base frequency. When a value other than 39 is set, the DC-AVR will function so that the set voltage is attained at the base frequency. When the rated input voltage setting (B00-0) is changed, this data is also changed to the rated input voltage value. This cannot be set above the rated input voltage.	<input type="radio"/>	<input type="radio"/>	<input type="radio"/>	<input type="radio"/>	6-108																																			
2	Max. frequency (Fmax_AU2) (Auxiliary drive 2)	Fbase_AU2 or 3.00	FBASE_AU2*7 or 440.00	50.00 (Hz)	When "B28-0" is a value other than 0, this will be rewritten with the data set in the simple setting.	<input type="radio"/>	<input type="radio"/>	<input type="radio"/>	<input type="radio"/>	6-108																																			
3	Base frequency (Fbase_AU2) (Auxiliary drive 2)	Fmax_AU2/7 or 1.00	Fmax_AU2 or 440.00	50.00 (Hz)		<input type="radio"/>	<input type="radio"/>	<input type="radio"/>	<input type="radio"/>	6-108																																			
4	Motor rated current (Auxiliary drive 2)	Inverter rating × 0.3	Inverter rating	Inverter rating (A)	This is the reference value for the overcurrent limit, OLT, current % display, analog input and output.	<input type="radio"/>	<input type="radio"/>	<input type="radio"/>	<input type="radio"/>	6-108																																			
5	Carrier frequency (Small size) (Auxiliary drive 2)	1.0	21.0	17.0	Refer to B00-7 for details on the settings.	<input type="radio"/>	<input type="radio"/>	<input type="radio"/>	<input type="radio"/>	6-108																																			
5	Carrier frequency (Large size) (Auxiliary drive 2)	1.0	14.0	10.0		<input type="radio"/>	<input type="radio"/>	<input type="radio"/>	<input type="radio"/>	6-108																																			
6	Start frequency (Auxiliary drive 2)	0.10	60.00	1.00 (Hz)	Operation starts from this frequency value when the motor starts.	<input type="radio"/>	<input type="radio"/>	<input type="radio"/>	<input type="radio"/>	6-108																																			
7	Stop frequency (Auxiliary drive 2)	0.10	60.00	1.00 (Hz)	The DC brakes are applied when the frequency value is less than this frequency value.	<input type="radio"/>	<input type="radio"/>	<input type="radio"/>	<input type="radio"/>	6-108																																			
8	Upper limit (Auxiliary drive 2)	-440.00	440.00	440.00 (Hz)	Make sure that the upper limit is greater than the lower limit	<input type="radio"/>	<input type="radio"/>	<input type="radio"/>	<input type="radio"/>	6-108																																			
9	Lower limit (Auxiliary drive 2)	-440.00	440.00	0.10 (Hz)		<input type="radio"/>	<input type="radio"/>	<input type="radio"/>	<input type="radio"/>	6-108																																			
B29 – Frequency setting (Auxiliary drive 2)																																													
0	Local frequency setting (Auxiliary drive 2)	0.10	Fmax_AU2	10.00 (Hz)	This is the frequency set from the operation panel.	<input type="radio"/>	<input type="radio"/>	<input type="radio"/>	<input type="radio"/>	6-108																																			
1	Frequency setting for jogging (Auxiliary drive 2)	0.10	Fmax_AU2	5.00 (Hz)	This is the frequency setting for jogging.	<input type="radio"/>	<input type="radio"/>	<input type="radio"/>	<input type="radio"/>	6-108																																			
2	Acceleration time - 1 (Auxiliary drive 2)	0.1	6000.0	10.0 (s)	The unit can be changed to ×0.1s, ×10s with the time unit setting (B10-5).	<input type="radio"/>	<input type="radio"/>	<input type="radio"/>	<input type="radio"/>	6-108																																			
3	Deceleration time - 1 (Auxiliary drive 2)	0.1	6000.0	20.0 (s)	The time to reach the max. frequency from 0 is set.	<input type="radio"/>	<input type="radio"/>	<input type="radio"/>	<input type="radio"/>	6-108																																			

6. Control Functions and Parameter Settings

Block-B parameters list

No.	Parameter	Min.	Max.	Default (Unit)	Function	Application				Ref. page
						Vf	VEC	PM	RWE	
B29 – Frequency setting (Auxiliary drive 2)										
4	Acceleration time - 2 (Auxiliary drive 2)	0.1	6000.0	10.0 (s)	This is the acceleration/deceleration ramp time setting made valid when the sequence command ramp 2 switch is ON (CSEL=ON). Set a time between 0 and the max. frequency or max. speed. The unit can be changed to ×0.1s, ×10s with the time unit setting (B10-5).	<input type="checkbox"/>	<input type="checkbox"/>	<input type="checkbox"/>	<input type="checkbox"/>	6-108
5	Deceleration time - 2 (Auxiliary drive 2)	0.1	6000.0	20.0 (s)		<input type="checkbox"/>	<input type="checkbox"/>	<input type="checkbox"/>	<input type="checkbox"/>	6-108
6	Acceleration time for jogging (Auxiliary drive 2)	0.1	6000.0	5.0 (s)	The acceleration/deceleration ramp time value when the JOG sequence (F JOG, R JOG) is valid is set. Set a time between 0 and the max. frequency. The unit can be changed to ×0.1s, ×10s with the time unit setting (B10-5).	<input type="checkbox"/>	<input type="checkbox"/>	<input type="checkbox"/>	<input type="checkbox"/>	6-108
7	Deceleration time for jogging (Auxiliary drive 2)	0.1	6000.0	2.0 (s)		<input type="checkbox"/>	<input type="checkbox"/>	<input type="checkbox"/>	<input type="checkbox"/>	6-108
B2A – Torque boost, DC Brake, Dc Brake setting, Overcurrent setting, Overload setting (Auxiliary drive 2)										
0	Manual torque boost setting (Auxiliary drive 2)	0.00	20.00	Inverter rating (%)	Set the boost voltage at 0Hz.	<input type="checkbox"/>	<input type="checkbox"/>	<input type="checkbox"/>	<input type="checkbox"/>	6-108
1	Square reduction torque setting (Auxiliary drive 2)	0.00	25.00	0.0 (%)	Set the reduced voltage at Base frequency/2.	<input type="checkbox"/>	<input type="checkbox"/>	<input type="checkbox"/>	<input type="checkbox"/>	6-108
2	DC braking voltage (Auxiliary drive 2)	0.01	20.00	Inverter rating (%)	When setting manually, monitor the output voltage and change the setting in increments of 1% or less.	<input type="checkbox"/>	<input type="checkbox"/>	<input type="checkbox"/>	<input type="checkbox"/>	6-108
3	DC braking time (Auxiliary drive 2)	0.0	20.0	2.0 (sec)	Set the time to apply the DC brakes.	<input type="checkbox"/>	<input type="checkbox"/>	<input type="checkbox"/>	<input type="checkbox"/>	6-108
4	Over current limit (Auxiliary drive 2)	50.	300.	125. (%)	The default value is 155. when heavy-duty is set.	<input type="checkbox"/>	<input type="checkbox"/>	<input type="checkbox"/>	<input type="checkbox"/>	6-108
5	Regenerative current limit (Auxiliary drive 2)	5.	300.	10. (%)	Set to 10% when not using the DBR option.	<input type="checkbox"/>	<input type="checkbox"/>	<input type="checkbox"/>	<input type="checkbox"/>	6-108
6	Torque stabilization gain (Auxiliary drive 2)	0.00	4.00	1.00	Increase or decrease by 0.05 units if the motor vibrates.	<input type="checkbox"/>	<input type="checkbox"/>	<input type="checkbox"/>	<input type="checkbox"/>	6-108
7	Motor overload reference (Auxiliary drive 2)	50.0	105.0	100.0 (%)	When this data is changed, the B2A-8, 9 data is limited to this value. Take care when decreasing and then increasing this value.	<input type="checkbox"/>	<input type="checkbox"/>	<input type="checkbox"/>	<input type="checkbox"/>	6-108
8	0Hz overload (Auxiliary drive 2)	20.0	105.0	100.0 (%)	The max. value is the B2A-9 value.	<input type="checkbox"/>	<input type="checkbox"/>	<input type="checkbox"/>	<input type="checkbox"/>	6-108
9	0.7Base freq. overload (Auxiliary drive 2)	50.0	105.0	100.0 (%)	The min. value is the B2A-8 value.	<input type="checkbox"/>	<input type="checkbox"/>	<input type="checkbox"/>	<input type="checkbox"/>	6-108
B2B – Braking on power failure setting (Auxiliary drive 2)										
0	Braking on power deceleration ramp time-1 (Auxiliary drive 2)	0.1	6000.0	10.0 (s)	Set the deceleration time from the maximum frequency value to 0Hz.	<input type="checkbox"/>	<input type="checkbox"/>	<input type="checkbox"/>	<input type="checkbox"/>	6-108
1	Braking on power deceleration ramp time-2 (Auxiliary drive 2)	0.0	6000.0	10.0 (s)	Set the deceleration time from the maximum frequency value to 0Hz. Deceleration is performed at deceleration ramp time-1 when 0.0.	<input type="checkbox"/>	<input type="checkbox"/>	<input type="checkbox"/>	<input type="checkbox"/>	6-108
2	Braking on power subtraction frequency (Auxiliary drive 2)	0.00	20.00	0.00 (Hz)	No subtraction made when 0.00Hz. 0Hz and brake engaged when the result of output frequency – subtraction frequency is 0 or less.	<input type="checkbox"/>	<input type="checkbox"/>	<input type="checkbox"/>	<input type="checkbox"/>	6-108
3	Braking on power subtraction start frequency (Auxiliary drive 2)	0.00	Fmax_AU2 or 999.99	0.00 (Hz)	If the output frequency is higher than this value, deceleration is performed from the result of output frequency – subtraction frequency. Subtraction is always performed when 999.9.	<input type="checkbox"/>	<input type="checkbox"/>	<input type="checkbox"/>	<input type="checkbox"/>	6-108
4	Braking on power switching frequency (Auxiliary drive 2)	0.00	Fmax_AU2	0.00 (Hz)	Switching is not performed when 0.00 to stoppage frequency or less.	<input type="checkbox"/>	<input type="checkbox"/>	<input type="checkbox"/>	<input type="checkbox"/>	6-108

6. Control Functions and Parameter Settings

Block-B parameters list

No.	Parameter	Min.	Max.	Default (Unit)	Function	Application				Ref. page																																			
						Vf	VEC	PM	RWE																																				
B2C – Output rating (Auxiliary drive 3)																																													
0	Max./base frequency simple setting (Auxiliary drive 3)	0.	9.	1.	Select the output frequency rating from the combination below.	<input type="radio"/>	<input type="radio"/>	<input type="radio"/>	<input type="radio"/>	6-108																																			
					<table border="1" style="width: 100%; border-collapse: collapse;"> <thead> <tr> <th>Value</th> <th>Ftrq [Hz]</th> <th>Fmax [Hz]</th> </tr> </thead> <tbody> <tr> <td>0</td> <td colspan="2">Free setting on B2C-4, 5</td> </tr> <tr> <td>1</td> <td>50</td> <td>50</td> </tr> <tr> <td>2</td> <td>60</td> <td>60</td> </tr> <tr> <td>3</td> <td>50</td> <td>60</td> </tr> <tr> <td>4</td> <td>50</td> <td>75</td> </tr> </tbody> </table> <table border="1" style="width: 100%; border-collapse: collapse;"> <thead> <tr> <th>Value</th> <th>Ftrq [Hz]</th> <th>Fmax [Hz]</th> </tr> </thead> <tbody> <tr> <td>5</td> <td>50</td> <td>100</td> </tr> <tr> <td>6</td> <td>60</td> <td>70</td> </tr> <tr> <td>7</td> <td>60</td> <td>80</td> </tr> <tr> <td>8</td> <td>60</td> <td>90</td> </tr> <tr> <td>9</td> <td>60</td> <td>120</td> </tr> </tbody> </table>	Value	Ftrq [Hz]	Fmax [Hz]	0	Free setting on B2C-4, 5		1	50	50	2	60	60	3	50	60	4	50	75	Value	Ftrq [Hz]	Fmax [Hz]	5	50	100	6	60	70	7	60	80	8	60	90	9	60	120				
Value	Ftrq [Hz]	Fmax [Hz]																																											
0	Free setting on B2C-4, 5																																												
1	50	50																																											
2	60	60																																											
3	50	60																																											
4	50	75																																											
Value	Ftrq [Hz]	Fmax [Hz]																																											
5	50	100																																											
6	60	70																																											
7	60	80																																											
8	60	90																																											
9	60	120																																											
1	Rated output voltage (Auxiliary drive 3)	39.	480.	230. or 400. (V)	DC-AVR will not function when 39 is set. The input voltage is the same as the output voltage at the base frequency. When a value other than 39 is set, the DC-AVR will function so that the set voltage is attained at the base frequency. When the rated input voltage setting (B00-0) is changed, this data is also changed to the rated input voltage value. This cannot be set above the rated input voltage.	<input type="radio"/>	<input type="radio"/>	<input type="radio"/>	<input type="radio"/>	6-108																																			
2	Max. frequency (Fmax_AU3) (Auxiliary drive 3)	Fbase_AU3 or 3.00	FBASE_AU3*7 or 440.00	50.00 (Hz)	When "B2C-0" is a value other than 0, this will be rewritten with the data set in the simple setting.	<input type="radio"/>	<input type="radio"/>	<input type="radio"/>	<input type="radio"/>	6-108																																			
3	Base frequency (Fbase_AU3) (Auxiliary drive 3)	Fmax_AU3/7 or 1.00	Fmax_AU3 or 440.00	50.00 (Hz)		<input type="radio"/>	<input type="radio"/>	<input type="radio"/>	<input type="radio"/>	6-108																																			
4	Motor rated current (Auxiliary drive 3)	Inverter rating × 0.3	Inverter rating	Inverter rating (A)	This is the reference value for the overcurrent limit, OLT, current % display, analog input and output.	<input type="radio"/>	<input type="radio"/>	<input type="radio"/>	<input type="radio"/>	6-108																																			
5	Carrier frequency (Small size) (Auxiliary drive 3)	1.0	21.0	17.0	Refer to B00-7 for details on the settings.	<input type="radio"/>	<input type="radio"/>	<input type="radio"/>	<input type="radio"/>	6-108																																			
5	Carrier frequency (Large size) (Auxiliary drive 3)	1.0	14.0	10.0		<input type="radio"/>	<input type="radio"/>	<input type="radio"/>	<input type="radio"/>	6-108																																			
6	Start frequency (Auxiliary drive 3)	0.10	60.00	1.00 (Hz)	Operation starts from this frequency value when the motor starts.	<input type="radio"/>	<input type="radio"/>	<input type="radio"/>	<input type="radio"/>	6-108																																			
7	Stop frequency (Auxiliary drive 3)	0.10	60.00	1.00 (Hz)	The DC brakes are applied when the frequency value is less than this frequency value.	<input type="radio"/>	<input type="radio"/>	<input type="radio"/>	<input type="radio"/>	6-108																																			
8	Upper limit (Auxiliary drive 3)	-440.00	440.00	440.00 (Hz)	Make sure that the upper limit is greater than the lower limit	<input type="radio"/>	<input type="radio"/>	<input type="radio"/>	<input type="radio"/>	6-108																																			
9	Lower limit (Auxiliary drive 3)	-440.00	440.00	0.10 (Hz)		<input type="radio"/>	<input type="radio"/>	<input type="radio"/>	<input type="radio"/>	6-108																																			
B2D – Frequency setting (Auxiliary drive 3)																																													
0	Local frequency setting (Auxiliary drive 3)	0.10	Fmax_AU3	10.00 (Hz)	This is the frequency set from the operation panel.	<input type="radio"/>	<input type="radio"/>	<input type="radio"/>	<input type="radio"/>	6-108																																			
1	Frequency setting for jogging (Auxiliary drive 3)	0.10	Fmax_AU3	5.00 (Hz)	This is the frequency setting for jogging.	<input type="radio"/>	<input type="radio"/>	<input type="radio"/>	<input type="radio"/>	6-108																																			
2	Acceleration time - 1 (Auxiliary drive 3)	0.1	6000.0	10.0 (s)	The unit can be changed to ×0.1s, ×10s with the time unit setting (B10-5). Set a time between 0 and the max. frequency or max. speed.	<input type="radio"/>	<input type="radio"/>	<input type="radio"/>	<input type="radio"/>	6-108																																			
3	Deceleration time - 1 (Auxiliary drive 3)	0.1	6000.0	20.0 (s)		<input type="radio"/>	<input type="radio"/>	<input type="radio"/>	<input type="radio"/>	6-108																																			

6. Control Functions and Parameter Settings

Block-B parameters list

No.	Parameter	Min.	Max.	Default (Unit)	Function	Application				Ref. page
						Vf	VEC	PM	RWE	
B2D – Frequency setting (Auxiliary drive 3)										
4	Acceleration time - 2 (Auxiliary drive 3)	0.1	6000.0	10.0 (s)	This is the acceleration/deceleration ramp time setting made valid when the sequence command ramp 2 switch is ON (CSEL=ON). Set a time between 0 and the max. frequency or max. speed. The unit can be changed to ×0.1s, ×10s with the time unit setting (B10-5). The acceleration/deceleration ramp time value when the JOG sequence (F JOG, R JOG) is valid is set. Set a time between 0 and the max. frequency. The unit can be changed to ×0.1s, ×10s with the time unit setting (B10-5).	<input type="checkbox"/>	<input type="checkbox"/>	<input type="checkbox"/>	<input type="checkbox"/>	6-108
5	Deceleration time - 2 (Auxiliary drive 0)	0.1	6000.0	20.0 (s)		<input type="checkbox"/>	<input type="checkbox"/>	<input type="checkbox"/>	<input type="checkbox"/>	6-108
6	Acceleration time for jogging (Auxiliary drive 3)	0.1	6000.0	5.0 (s)		<input type="checkbox"/>	<input type="checkbox"/>	<input type="checkbox"/>	<input type="checkbox"/>	6-108
7	Deceleration time for jogging (Auxiliary drive 3)	0.1	6000.0	2.0 (s)		<input type="checkbox"/>	<input type="checkbox"/>	<input type="checkbox"/>	<input type="checkbox"/>	6-108
B2E – Torque boost, DC Brake, DC Brake setting, Overcurrent setting, Overload setting (Auxiliary drive 3)										
0	Manual torque boost setting (Auxiliary drive 3)	0.00	20.00	Inverter rating (%)	Set the boost voltage at 0Hz.	<input type="checkbox"/>	<input type="checkbox"/>	<input type="checkbox"/>	<input type="checkbox"/>	6-108
1	Square reduction torque setting (Auxiliary drive 3)	0.00	25.00	0.0 (%)	Set the reduced voltage at Base frequency/2.	<input type="checkbox"/>	<input type="checkbox"/>	<input type="checkbox"/>	<input type="checkbox"/>	6-108
2	DC braking voltage (Auxiliary drive 3)	0.01	20.00	Inverter rating (%)	This is automatically adjusted by the automatic tuning.	<input type="checkbox"/>	<input type="checkbox"/>	<input type="checkbox"/>	<input type="checkbox"/>	6-108
3	DC braking time (Auxiliary drive 3)	0.0	20.0	2.0 (s)	Set the time to apply the DC brakes.	<input type="checkbox"/>	<input type="checkbox"/>	<input type="checkbox"/>	<input type="checkbox"/>	6-108
4	Over current limit (Auxiliary drive 3)	50.	300.	125. (%)	The default value is 155. when heavy-duty is set.	<input type="checkbox"/>	<input type="checkbox"/>	<input type="checkbox"/>	<input type="checkbox"/>	6-108
5	Regenerative current limit (Auxiliary drive 3)	5.	300.	10. (%)	Set to 10% when not using the DBR option.	<input type="checkbox"/>	<input type="checkbox"/>	<input type="checkbox"/>	<input type="checkbox"/>	6-108
6	Torque stabilization gain (Auxiliary drive 3)	0.00	4.00	1.00	Increase or decrease by 0.05 units if the motor vibrates.	<input type="checkbox"/>	<input type="checkbox"/>	<input type="checkbox"/>	<input type="checkbox"/>	6-108
7	Motor overload reference (Auxiliary drive 3)	50.0	105.0	100.0 (%)	When this data is changed, the B2E-8, 9 data is limited to this value. Take care when decreasing and then increasing this value.	<input type="checkbox"/>	<input type="checkbox"/>	<input type="checkbox"/>	<input type="checkbox"/>	6-108
8	0Hz overload (Auxiliary drive 3)	20.0	105.0	100.0 (%)	The max. value is the B2E-9 value.	<input type="checkbox"/>	<input type="checkbox"/>	<input type="checkbox"/>	<input type="checkbox"/>	6-108
9	0.7Base freq. overload (Auxiliary drive 3)	50.0	105.0	100.0 (%)	The min. value is the B2E-8 value.	<input type="checkbox"/>	<input type="checkbox"/>	<input type="checkbox"/>	<input type="checkbox"/>	6-108
B2F – Braking on power failure setting (Auxiliary drive 3)										
0	Braking on power deceleration ramp time-1 (Auxiliary drive 3)	0.1	6000.0	10.0 (s)	Set the deceleration time from the maximum frequency value to 0Hz.	<input type="checkbox"/>	<input type="checkbox"/>	<input type="checkbox"/>	<input type="checkbox"/>	6-108
1	Braking on power deceleration ramp time-2 (Auxiliary drive 3)	0.0	6000.0	10.0 (s)	Set the deceleration time from the maximum frequency value to 0Hz. Deceleration is performed at deceleration ramp time-1 when 0.0.	<input type="checkbox"/>	<input type="checkbox"/>	<input type="checkbox"/>	<input type="checkbox"/>	6-108
2	Braking on power subtraction frequency (Auxiliary drive 3)	0.00	20.00	0.00 (Hz)	No subtraction made when 0.00Hz. 0Hz and brake engaged when the result of output frequency – subtraction frequency is 0 or less.	<input type="checkbox"/>	<input type="checkbox"/>	<input type="checkbox"/>	<input type="checkbox"/>	6-108
3	Braking on power subtraction start frequency (Auxiliary drive 3)	0.00	Fmax_AU3 or 999.99	0.00 (Hz)	If the output frequency is higher than this value, deceleration is performed from the result of output frequency – subtraction frequency. Subtraction is always performed when 999.9.	<input type="checkbox"/>	<input type="checkbox"/>	<input type="checkbox"/>	<input type="checkbox"/>	6-108
4	Braking on power switching frequency (Auxiliary drive 3)	0.00	Fmax_AU3	0.00 (Hz)	Switching is not performed when 0.00 to stoppage frequency or less.	<input type="checkbox"/>	<input type="checkbox"/>	<input type="checkbox"/>	<input type="checkbox"/>	6-108

6. Control Functions and Parameter Settings

Block-B parameters list

No.	Parameter	Min.	Max.	Default (Unit)	Function	Application				Ref. page
						V/f	VEC	PM	RWE	
B30 – Speed control extended function										
0	Load torque observer gain (Speed control extended function)	0.0	200.0	0.0	Set the observer gain for the load torque observer. To increase the responsiveness of the external disturbance response characteristics, set a large gain. Note that if the gain is set too high, the output torque could hunt. When set to zero, the load torque observer will not function.		<input type="radio"/>	<input type="radio"/>	<input type="radio"/>	6-108
1	Model machine time constant (Speed control extended function)	10.	20000.	500. (ms)	Set the model machine time constant used by the load torque observer.		<input type="radio"/>	<input type="radio"/>	<input type="radio"/>	6-108
2	ASR proportional item change rate limit (Speed control extended function)	1.0	400.0	50.0 (%)	If the speed setting value or motor speed change suddenly, this will prevent the ASR's P item from suddenly changing.		<input type="radio"/>	<input type="radio"/>	<input type="radio"/>	6-108
3	Speed setting LPF time constant (Speed control extended function)	0.	1000.	0. (ms)	Overshooting can be suppressed by setting this to the filter time constant equivalent to the speed response.		<input type="radio"/>	<input type="radio"/>	<input type="radio"/>	6-109
4	Speed detection LPF time constant (Speed control extended function)	0.	1000.	2. (ms)	The speed detection noise is cut.	<input type="radio"/>	<input type="radio"/>	<input type="radio"/>	<input type="radio"/>	6-109
5	Speed detection LPF time constant for ASR (Speed control extended function)	0.	1000.	5. (ms)	Set the low path filter time constant used for the speed detection value input into the speed regulator.		<input type="radio"/>	<input type="radio"/>	<input type="radio"/>	6-109
6	Speed detection LPF time constant for compensation (Speed control extended function)	0.	1000.	20. (ms)	Set the low path filter time constant used for the speed detection value for constant output range compensation or iron loss compensation, etc.		<input type="radio"/>	<input type="radio"/>	<input type="radio"/>	6-109
7	Torque current command setting LPF time constant (Speed control extended function)	0.	1000.	0. (ms)	Set the low path filter time constant used for the torque current command.		<input type="radio"/>	<input type="radio"/>	<input type="radio"/>	6-109
8	LPF time constant for drooping (Speed control extended function)	0.	1000.	100. (ms)	Set the low path filter time constant used for drooping value input into the speed regulator.		<input type="radio"/>	<input type="radio"/>	<input type="radio"/>	6-109

6. Control Functions and Parameter Settings

Block-B parameters list

No.	Parameter	Min.	Max.	Default (Unit)	Function	Application				Ref. page
						V/f	VEC	PM	RWE	
B31 – Sensor-less control function										
0	Flux observer gain (Sensor-less control function)	0.50	1.50	1.00	This is the feedback gain for the flux observer. If hunting occurs at the estimated speed in the high-speed operation range, adjust within the range of 1.2 to 0.9.		<input type="radio"/>		<input type="radio"/>	6-109
1	Speed estimated proportional gain (Sensor-less control function)	0.00	100.00	10.00 (%)	This is the proportional gain for the adaptive speed estimation mechanism. To increase the speed estimation response, set a large value. Note that if the value is too high, the speed estimation value will hunt.		<input type="radio"/>		<input type="radio"/>	6-109
2	Speed estimated integral gain (Sensor-less control function)	0.00	100.0	0.10 (%)	This is the integral gain for the adaptive speed estimation mechanism. To increase the speed estimation response, set a large value. Note that if the value is too high, the speed estimation value will hunt.		<input type="radio"/>		<input type="radio"/>	6-109
3	Regenerative compensation torque limiter 1 (Sensor-less control function)	0.1	100.0	10.00 (%)	The regenerative torque limiter can be changed in the low-speed area. The shaded section shows the operation range. If operation is unstable within the shaded line range, set the parameter so that the unstable point is not within the shaded line area.		<input type="radio"/>		<input type="radio"/>	6-110
4	Regenerative compensation torque limiter 2 (Sensor-less control function)	0.1	100.0	20.00 (%)			<input type="radio"/>		<input type="radio"/>	6-110
5	Regenerative compensation low-speed area setting 1 (Sensor-less control function)	0.1	100.0	10.00 (%)			<input type="radio"/>		<input type="radio"/>	6-110
6	Regenerative compensation low-speed area setting 2 (Sensor-less control function)	0.1	100.0	20.00 (%)			<input type="radio"/>		<input type="radio"/>	6-110

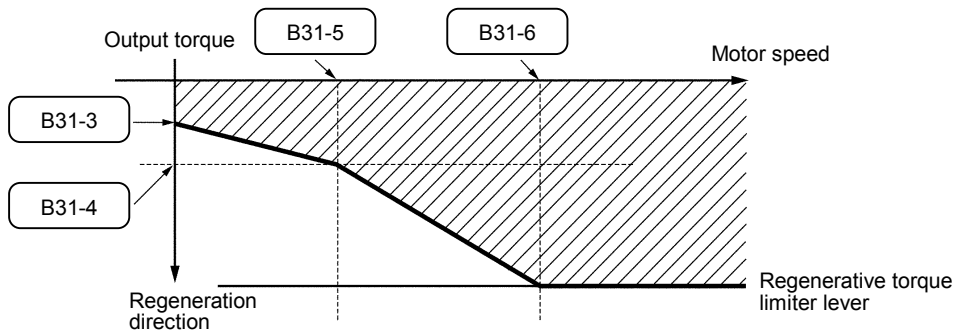

6. Control Functions and Parameter Settings

Block-B parameters list

No.	Parameter	Min.	Max.	Default (Unit)	Function	Application				Ref. page
						V/f	VEC	PM	RWE	
B32 – Vector control compensation selection • Extended function control										
0	High-speed flux control gain	1.	50.	1.	= 1: Disable = 2 to 50: Enable This is the control gain used for high-speed control of the secondary flux when starting operation. Use this to control the secondary flux at a high speed at the start of operation or during operation in a constant output range. High speed control is possible by increasing the gain, but if increased too high, the magnetizing current may hunt.		○			6-110
1	Temperature compensation selection	1.	2.	1.	= 1: Disable = 2: Enable If torque accuracy is required when vector control with sensor is selected (C30-0: f0 = 3), or if speed accuracy is required when sensor-less vector control is selected (C30-0: f0 = 2), the parameter fluctuation of the primary resistance value and secondary resistance value caused by a rise in temperature can be compensated.		○			6-110
2	Voltage saturation compensation selection	1.	2.	1.	= 1: Disable = 2: Enable If the output voltage in control is larger than the voltage that can be output by the inverter, select this control to limit the exciting current to prevent the current or torque from hunting. Select this when raising the output voltage to near the input voltage, or when the input voltage changes. Note that if voltage saturation occurs, some torque ripple will occur. In this case, lower the B01-9 no-load voltage setting to avoid voltage saturation.		○		○	6-110
3	Iron loss compensation selection	1.	2.	1.	= 1: Disable = 2: Enable This compensates the torque error caused by iron loss. The iron loss resistance value (B02-8, 9) must be set.		○		○	6-111
4	ACR voltage model FF selection	1.	2.	2.	= 1: Disable = 2: Enable The voltage fluctuation caused by the leakage inductance is feed forward controlled. The current regulator (ACR) response speed will be increased. Select this if the current hunts in the high-speed operation range during sensor-less control.		○	○		6-111
5	ACR model voltage FF compensation	0.0	200.0	0.0 (%)	dq axis current non-interference voltage Set this when the ASR proportional gain is high. Set the value between approx. 50.0 and 80.0%.		○	○	○	6-111
6	ACR proportional section dead time compensating factor	0.0	200.0	0.0 (%)	If a 3ms cycle current vibration is generated at 120Hz or more, set a value between approx. 50.0 and 80.0%.		○	○	○	6-111

6. Control Functions and Parameter Settings

Block-B parameters list

No.	Parameter	Min.	Max.	Default (Unit)	Function	Application				Ref. page
						V/F	VEC	PM	RWE	
B33 – M fluctuation compensation table reference speed										
0	Table reference speed 0 (M fluctuation compensation)	100.	9999.	200 (min ⁻¹)	This is the reference speed for changing the compensation amount according to the operation speed. If all of B34 is set to the default value (100.0), these will be automatically set when adjusted with automatic tuning mode 4 (B19-0=4).		<input type="radio"/>			6-111
1	Table reference speed 1 (M fluctuation compensation)	100.	9999.	400 (min ⁻¹)			<input type="radio"/>			6-111
2	Table reference speed 2 (M fluctuation compensation)	100.	9999.	600 (min ⁻¹)			<input type="radio"/>			6-111
3	Table reference speed 3 (M fluctuation compensation)	100.	9999.	800 (min ⁻¹)			<input type="radio"/>			6-111
4	Table reference speed 4 (M fluctuation compensation)	100.	9999.	1000 (min ⁻¹)			<input type="radio"/>			6-111
5	Table reference speed 5 (M fluctuation compensation)	100.	9999.	1200 (min ⁻¹)			<input type="radio"/>			6-111
6	Table reference speed 6 (M fluctuation compensation)	100.	9999.	1400 (min ⁻¹)			<input type="radio"/>			6-111
7	Table reference speed 7 (M fluctuation compensation)	100.	9999.	1600 (min ⁻¹)			<input type="radio"/>			6-111
B34 – M fluctuation compensation										
0	M fluctuation compensation coefficient 0	50.0	150.0	100.0 (%)	This compensates the exciting inductance fluctuation according to the B33 table reference speed. Set the compensation table so that the output voltage is constant during no-load operation through the entire operation range. * This is adjusted with the automatic tuning mode 4 (B19-0 = 4).		<input type="radio"/>	<input type="radio"/>		6-111
1	M fluctuation compensation coefficient 1	50.0	150.0	100.0 (%)			<input type="radio"/>	<input type="radio"/>		6-111
2	M fluctuation compensation coefficient 2	50.0	150.0	100.0 (%)			<input type="radio"/>	<input type="radio"/>		6-111
3	M fluctuation compensation coefficient 3	50.0	150.0	100.0 (%)			<input type="radio"/>	<input type="radio"/>		6-111
4	M fluctuation compensation coefficient 4	50.0	150.0	100.0 (%)			<input type="radio"/>	<input type="radio"/>		6-111
5	M fluctuation compensation coefficient 5	50.0	150.0	100.0 (%)			<input type="radio"/>	<input type="radio"/>		6-111
6	M fluctuation compensation coefficient 6	50.0	150.0	100.0 (%)			<input type="radio"/>	<input type="radio"/>		6-111
7	M fluctuation compensation coefficient 7	50.0	150.0	100.0 (%)			<input type="radio"/>	<input type="radio"/>		6-111
B35 – Voltage saturation prevention control constant										
0	Voltage saturation prevention current voltage allowance	0.0	100.0	10.0 (%/V1)	Refer to section 6-9 for details.			<input type="radio"/>	<input type="radio"/>	6-112
1	Largest voltage setting	50.0	200.0	100.0 (%/V1)				<input type="radio"/>	<input type="radio"/>	6-112
2	Weak field current limit value	10.0	200.0	50.0 (%/I1)				<input type="radio"/>	<input type="radio"/>	6-112
3	Voltage saturation prevention current proportional gain	0.01	99.99	0.10				<input type="radio"/>	<input type="radio"/>	6-112
4	Voltage saturation prevention control integral time constant	2.	1000.	10. (ms)				<input type="radio"/>	<input type="radio"/>	6-112

6. Control Functions and Parameter Settings

Block-B parameters list

No.	Parameter	Min.	Max.	Default (Unit)	Function	Application				Ref. page
						V/f	VEC	PM	RWE	
B36 – Field weakening electric current table (PM motor control)										
0	Field weakening electric current table 0 (at torque command 0%)	-100.0	100.0	0.0 (%/11)	Refer to section 6-9 for details.			○	○	6-112
1	Field weakening electric current table 1 (at torque command 25%)	-100.0	100.0	0.0 (%/11)				○	○	6-112
2	Field weakening electric current table 2 (at torque command 50%)	-100.0	100.0	0.0 (%/11)				○	○	6-112
3	Field weakening electric current table 3 (at torque command 75%)	-100.0	100.0	0.0 (%/11)				○	○	6-112
4	Field weakening electric current table 4 (at torque command 100%)	-100.0	100.0	0.0 (%/11)				○	○	6-112
5	Field weakening electric current table 5 (at torque command 125%)	-100.0	100.0	0.0 (%/11)				○	○	6-112
6	Field weakening electric current table 6 (at torque command 150%)	-100.0	100.0	0.0 (%/11)				○	○	6-112
B38 – Torque to Iq conversion adjustment coefficient table (PM)										
0	Torque to Iq conversion adjustment coefficient (at Id command -100%)	0.	200.	100. (%/11)	Refer to section 6-9 for details.			○	○	6-112
1	Torque to Iq conversion adjustment coefficient (at Id command -75%)	0.	200.	100. (%/11)				○	○	6-112
2	Torque to Iq conversion adjustment coefficient (at Id command -50%)	0.	200.	100. (%/11)				○	○	6-112
3	Torque to Iq conversion adjustment coefficient (at Id command -25%)	0.	200.	100. (%/11)				○	○	6-112
4	Torque to Iq conversion adjustment coefficient (at Id command 0%)	0.	200.	100. (%/11)				○	○	6-112
5	Torque to Iq conversion adjustment coefficient (at Id command 25%)	0.	200.	100. (%/11)				○	○	6-112
6	Torque to Iq conversion adjustment coefficient (at Id command 50%)	0.	200.	100. (%/11)				○	○	6-112
B39 – Pole position presumption (PM)										
0	Pole presumption selection (PM)	11.	23.	11.	f0=1: Magnetic pole position estimation OFF =2: Estimation with secondary phase =3: Estimation with primary phase (only special SPM) f1=1: Run at Z pulse reference =2: Run at estimation phase reference			○		6-112
1	At the time of pole presumption pulse voltage (PM)	10.	100.	50. (%)	Set the voltage amplitude for measurement. The motor's rated voltage is 100%.			○		6-112
2	At the time of pole presumption pulse width (PM)	2.	32.	4.	Set the voltage width for measurement.			○		6-112
3	Voltage error correction current (PM)	0.	50.	10. (%)	Set the current amplitude for correcting the voltage error. The motor's rated voltage is 100%.			○		6-112

6. Control Functions and Parameter Settings

Block-B parameters (S/W option constants) list

No.	Parameter	Min.	Max.	Default (Unit)	Function	Application				Ref. page																																																																																																																																		
						V/F	VEC	PM	RWE																																																																																																																																			
B40 – Software option function																																																																																																																																												
0	Function selection - 1 (Software option function)	1.	8.	1	= 1: Following functions are not used. = 2: Program ramp function use = 3: Pattern run use = 4: Traverse run use = 5: PID use = 6: PID, multi-pump control use (No main pump rotation) = 7: PID, multi-pump control use (Main pump rotation performed, 1-contact method) = 8: PID, multi-pump control use (Main pump rotation performed, 2-contact method)					6-112																																																																																																																																		
B41 – Program ramp – acceleration																																																																																																																																												
0	Acceleration ramp time - 0	0.1	6000.0	10.0 (s)	Select as follows with S0, S1, S2, S3 and SE.	<input type="radio"/>	<input type="radio"/>	<input type="radio"/>	<input type="radio"/>	6-113																																																																																																																																		
1	Acceleration ramp time - 1	0.1	6000.0	10.0 (s)		<input type="radio"/>	<input type="radio"/>	<input type="radio"/>	<input type="radio"/>	6-113																																																																																																																																		
2	Acceleration ramp time - 2	0.1	6000.0	10.0 (s)		<input type="radio"/>	<input type="radio"/>	<input type="radio"/>	<input type="radio"/>	6-113																																																																																																																																		
3	Acceleration ramp time - 3	0.1	6000.0	10.0 (s)		<input type="radio"/>	<input type="radio"/>	<input type="radio"/>	<input type="radio"/>	6-113																																																																																																																																		
4	Acceleration ramp time - 4	0.1	6000.0	10.0 (s)		<input type="radio"/>	<input type="radio"/>	<input type="radio"/>	<input type="radio"/>	6-113																																																																																																																																		
5	Acceleration ramp time - 5	0.1	6000.0	10.0 (s)		<input type="radio"/>	<input type="radio"/>	<input type="radio"/>	<input type="radio"/>	6-113																																																																																																																																		
6	Acceleration ramp time - 6	0.1	6000.0	10.0 (s)		<input type="radio"/>	<input type="radio"/>	<input type="radio"/>	<input type="radio"/>	6-113																																																																																																																																		
7	Acceleration ramp time - 7	0.1	6000.0	10.0 (s)		<input type="radio"/>	<input type="radio"/>	<input type="radio"/>	<input type="radio"/>	6-113																																																																																																																																		
B42 – Program ramp – deceleration																																																																																																																																												
0	Deceleration ramp time - 0	0.1	6000.0	20.0 (s)	Select as follows with S0, S1, S2, S3 and SE.	<input type="radio"/>	<input type="radio"/>	<input type="radio"/>	<input type="radio"/>	6-113																																																																																																																																		
1	Deceleration ramp time - 1	0.1	6000.0	20.0 (s)		<input type="radio"/>	<input type="radio"/>	<input type="radio"/>	<input type="radio"/>	6-113																																																																																																																																		
2	Deceleration ramp time - 2	0.1	6000.0	20.0 (s)		<input type="radio"/>	<input type="radio"/>	<input type="radio"/>	<input type="radio"/>	6-113																																																																																																																																		
3	Deceleration ramp time - 3	0.1	6000.0	20.0 (s)		<input type="radio"/>	<input type="radio"/>	<input type="radio"/>	<input type="radio"/>	6-113																																																																																																																																		
4	Deceleration ramp time - 4	0.1	6000.0	20.0 (s)		<input type="radio"/>	<input type="radio"/>	<input type="radio"/>	<input type="radio"/>	6-113																																																																																																																																		
5	Deceleration ramp time - 5	0.1	6000.0	20.0 (s)		<input type="radio"/>	<input type="radio"/>	<input type="radio"/>	<input type="radio"/>	6-113																																																																																																																																		
6	Deceleration ramp time - 6	0.1	6000.0	20.0 (s)		<input type="radio"/>	<input type="radio"/>	<input type="radio"/>	<input type="radio"/>	6-113																																																																																																																																		
7	Deceleration ramp time - 7	0.1	6000.0	20.0 (s)		<input type="radio"/>	<input type="radio"/>	<input type="radio"/>	<input type="radio"/>	6-113																																																																																																																																		
<div style="display: flex; justify-content: space-between;"> <div style="width: 48%;"> <p>(1) For binary mode (B11-8=1)</p> <table border="1" style="width: 100%; border-collapse: collapse; text-align: center;"> <thead> <tr> <th colspan="5">Sequence command</th> <th rowspan="2">Selected ramp time</th> </tr> <tr> <th>SE</th> <th>S3</th> <th>S2</th> <th>S1</th> <th>S0</th> </tr> </thead> <tbody> <tr> <td></td> <td></td> <td>OFF</td> <td>OFF</td> <td>OFF</td> <td>B41-0 B42-0</td> </tr> <tr> <td></td> <td></td> <td>OFF</td> <td>OFF</td> <td>ON</td> <td>B41-1 B42-1</td> </tr> <tr> <td></td> <td></td> <td>OFF</td> <td>ON</td> <td>OFF</td> <td>B41-2 B42-2</td> </tr> <tr> <td></td> <td></td> <td>OFF</td> <td>ON</td> <td>ON</td> <td>B41-3 B42-3</td> </tr> <tr> <td></td> <td></td> <td>ON</td> <td>OFF</td> <td>OFF</td> <td>B41-4 B42-4</td> </tr> <tr> <td></td> <td></td> <td>ON</td> <td>OFF</td> <td>ON</td> <td>B41-5 B42-5</td> </tr> <tr> <td></td> <td></td> <td>ON</td> <td>ON</td> <td>OFF</td> <td>B41-6 B42-6</td> </tr> <tr> <td></td> <td></td> <td>ON</td> <td>ON</td> <td>ON</td> <td>B41-7 B42-7</td> </tr> </tbody> </table> <p>* : SE and S3 are not used.</p> </div> <div style="width: 48%;"> <p>(2) For direct select mode (B11-8=2)</p> <table border="1" style="width: 100%; border-collapse: collapse; text-align: center;"> <thead> <tr> <th colspan="5">Sequence command</th> <th rowspan="2">Selected ramp time</th> </tr> <tr> <th>SE</th> <th>S3</th> <th>S2</th> <th>S1</th> <th>S0</th> </tr> </thead> <tbody> <tr> <td>OFF</td> <td>OFF</td> <td>OFF</td> <td>OFF</td> <td>OFF</td> <td>Previous values</td> </tr> <tr> <td>OFF</td> <td>OFF</td> <td>OFF</td> <td>OFF</td> <td>ON</td> <td>B41-0 B42-0</td> </tr> <tr> <td>OFF</td> <td>OFF</td> <td>OFF</td> <td>ON</td> <td>OFF</td> <td>B41-1 B42-1</td> </tr> <tr> <td>OFF</td> <td>OFF</td> <td>ON</td> <td>OFF</td> <td>OFF</td> <td>B41-2 B42-2</td> </tr> <tr> <td>OFF</td> <td>ON</td> <td>OFF</td> <td>OFF</td> <td>OFF</td> <td>B41-3 B42-3</td> </tr> <tr> <td>ON</td> <td>OFF</td> <td>OFF</td> <td>OFF</td> <td>OFF</td> <td>Previous values</td> </tr> <tr> <td>ON</td> <td>OFF</td> <td>OFF</td> <td>OFF</td> <td>ON</td> <td>B41-4 B42-4</td> </tr> <tr> <td>ON</td> <td>OFF</td> <td>OFF</td> <td>ON</td> <td>OFF</td> <td>B41-5 B42-5</td> </tr> <tr> <td>ON</td> <td>OFF</td> <td>ON</td> <td>OFF</td> <td>OFF</td> <td>B41-6 B42-6</td> </tr> <tr> <td>ON</td> <td>ON</td> <td>OFF</td> <td>OFF</td> <td>OFF</td> <td>B41-7 B42-7</td> </tr> </tbody> </table> <p>When S0 to S3 are all OFF, or when two or more are set between S0 and S3, the previous values will be held. If there are no previous values because the power has been turned ON, etc., "0" will be set.</p> </div> </div>											Sequence command					Selected ramp time	SE	S3	S2	S1	S0			OFF	OFF	OFF	B41-0 B42-0			OFF	OFF	ON	B41-1 B42-1			OFF	ON	OFF	B41-2 B42-2			OFF	ON	ON	B41-3 B42-3			ON	OFF	OFF	B41-4 B42-4			ON	OFF	ON	B41-5 B42-5			ON	ON	OFF	B41-6 B42-6			ON	ON	ON	B41-7 B42-7	Sequence command					Selected ramp time	SE	S3	S2	S1	S0	OFF	OFF	OFF	OFF	OFF	Previous values	OFF	OFF	OFF	OFF	ON	B41-0 B42-0	OFF	OFF	OFF	ON	OFF	B41-1 B42-1	OFF	OFF	ON	OFF	OFF	B41-2 B42-2	OFF	ON	OFF	OFF	OFF	B41-3 B42-3	ON	OFF	OFF	OFF	OFF	Previous values	ON	OFF	OFF	OFF	ON	B41-4 B42-4	ON	OFF	OFF	ON	OFF	B41-5 B42-5	ON	OFF	ON	OFF	OFF	B41-6 B42-6	ON	ON	OFF	OFF	OFF	B41-7 B42-7
Sequence command					Selected ramp time																																																																																																																																							
SE	S3	S2	S1	S0																																																																																																																																								
		OFF	OFF	OFF	B41-0 B42-0																																																																																																																																							
		OFF	OFF	ON	B41-1 B42-1																																																																																																																																							
		OFF	ON	OFF	B41-2 B42-2																																																																																																																																							
		OFF	ON	ON	B41-3 B42-3																																																																																																																																							
		ON	OFF	OFF	B41-4 B42-4																																																																																																																																							
		ON	OFF	ON	B41-5 B42-5																																																																																																																																							
		ON	ON	OFF	B41-6 B42-6																																																																																																																																							
		ON	ON	ON	B41-7 B42-7																																																																																																																																							
Sequence command					Selected ramp time																																																																																																																																							
SE	S3	S2	S1	S0																																																																																																																																								
OFF	OFF	OFF	OFF	OFF	Previous values																																																																																																																																							
OFF	OFF	OFF	OFF	ON	B41-0 B42-0																																																																																																																																							
OFF	OFF	OFF	ON	OFF	B41-1 B42-1																																																																																																																																							
OFF	OFF	ON	OFF	OFF	B41-2 B42-2																																																																																																																																							
OFF	ON	OFF	OFF	OFF	B41-3 B42-3																																																																																																																																							
ON	OFF	OFF	OFF	OFF	Previous values																																																																																																																																							
ON	OFF	OFF	OFF	ON	B41-4 B42-4																																																																																																																																							
ON	OFF	OFF	ON	OFF	B41-5 B42-5																																																																																																																																							
ON	OFF	ON	OFF	OFF	B41-6 B42-6																																																																																																																																							
ON	ON	OFF	OFF	OFF	B41-7 B42-7																																																																																																																																							

6. Control Functions and Parameter Settings

Block-B parameters (S/W option constants) list

No.	Parameter	Min.	Max.	Default (Unit)	Function	Application				Ref. page
						Vf	VEC	PM	RWE	
B43 – PID control										
0	Proportional gain (PID control)	0.01	10.00	1.00		<input type="radio"/>	<input type="radio"/>	<input type="radio"/>	<input type="radio"/>	6-114
1	Integral time constant (PID control)	0.0	30.0	10.0 (s)		<input type="radio"/>	<input type="radio"/>	<input type="radio"/>	<input type="radio"/>	6-114
2	Differential time constant (PID control)	0.000	1.000	0.000 (s)		<input type="radio"/>	<input type="radio"/>	<input type="radio"/>	<input type="radio"/>	6-114
3	Upper limit (PID control)	5.0	100.0	100.0 (%)	The maximum frequency and maximum speed are 100%	<input type="radio"/>	<input type="radio"/>	<input type="radio"/>	<input type="radio"/>	6-114
4	Lower limit (PID control)	0.0	50.0	0.0 (%)		<input type="radio"/>	<input type="radio"/>	<input type="radio"/>	<input type="radio"/>	6-114
5	Detected error determination start level (PID control)	0.0	100.0	0.0 (%)	Error determination is commenced if the command value is this value or higher.	<input type="radio"/>	<input type="radio"/>	<input type="radio"/>	<input type="radio"/>	6-114
6	Detected error level (PID control)	0.0	100.0	0.0 (%)	An error occurs if the detected value is this value or lower.	<input type="radio"/>	<input type="radio"/>	<input type="radio"/>	<input type="radio"/>	6-114
7	Detected error determination time (PID control)	0.0	25.0	0.0 (s)	A breakdown (I0-B.) occurs if the error continues this length of time or longer.	<input type="radio"/>	<input type="radio"/>	<input type="radio"/>		6-114
8	Polarity reverse flag (PID control)	1.	2.	1.	The command and detection polarity is reversed. =1: Normal =2: Reversed	<input type="radio"/>	<input type="radio"/>	<input type="radio"/>		6-114
9	PID operation method (PID control)	11.	22.	11.	PID operation method selection f0: PID operation conditions =1: RUN and PIDEN AND conditions =2: PIDEN f1: RUN conditions =1: RUN operation (normal operation) =2: Stop occurs when the PID output reaches the lower limiter.	<input type="radio"/>	<input type="radio"/>	<input type="radio"/>		6-114
A	Hysteresis when restarting operation (PID control)	1.0	10.0	3.0 (%)	Set the PID output hysteresis width when restarting operation when B43-9=22.	<input type="radio"/>	<input type="radio"/>	<input type="radio"/>		6-114
B44 – Multi-pump control										
0	No. of controlled pumps (Multi-pump control)	1.	8.	3.	Set the No. of pumps to be ON/OFF controlled.	<input type="radio"/>				6-116
1	Pump start holding time (Multi-pump control)	0.1	3600.0	60.0 (s)	If the time that the PID output is applied on the upper limiter is longer than this setting, the pump's ON control will be carried out.	<input type="radio"/>				6-116
2	Pump stop holding time (Multi-pump control)	0.1	3600.0	60.0 (s)	If the time that the PID output is applied on the lower limiter is longer than this setting, the pump's OFF control will be carried out.	<input type="radio"/>				6-116
3	Maximum continuous operation time (Multi-pump control)	0.0	168.0	8.0 (h)	If the pump's ON/OFF control is not carried out for longer than the time set here, the pumps will change from that operating to the longest to that operating the shortest so that the operation time of each pump is equal. Changing is prohibited when =0.0 is set.	<input type="radio"/>				6-116
4	Changeover time (Multi-pump control)	1.0	120.0	3.0 (s)	Set the time for changing from the pump that has been operating the longest to the pump that has been operating the shortest.	<input type="radio"/>				6-116
5	INV/main switching dead time setting (Multi-pump control)	0.2	10.0	1.0 (s)	Set the dead time for switching the INV and main power supply during main pump rotation.	<input type="radio"/>				6-116
6	Inverter control method at lower limit (Multi-pump control)	1.	2.	1.	Select whether to stop the INV or continue operation when the other auxiliary motor is stopped and the lower limit state is continued. =1: Stop =2: Continue running	<input type="radio"/>				6-116

6. Control Functions and Parameter Settings

Block-B parameters (S/W option constants) list

No.	Parameter	Min.	Max.	Default (Unit)	Function	Application				Ref. page
						Vf	VEC	PM	RWE	
B45 – Traverse run										
0	Traverse run: Center frequency (speed) (FH)	5.00	100.00	20.00 (%)	Set the center frequency for traverse operation.	<input type="checkbox"/>	<input type="checkbox"/>	<input type="checkbox"/>	<input type="checkbox"/>	6-122
1	Traverse run: Amplitude (A)	0.1	20.0	10.0 (%)	Set the upper/lower peak frequency from the traverse center frequency.	<input type="checkbox"/>	<input type="checkbox"/>	<input type="checkbox"/>	<input type="checkbox"/>	6-122
2	Traverse run: Drop (D)	0.0	50.0	0.0 (%)	When a value other than 0.0 is set, the frequency is dropped by the set amount after reaching the peak.	<input type="checkbox"/>	<input type="checkbox"/>	<input type="checkbox"/>	<input type="checkbox"/>	6-122
3	Traverse run: Acceleration time (B)	0.5	60.0	10.0 (s)	Set the time from the lower peak to the upper peak.	<input type="checkbox"/>	<input type="checkbox"/>	<input type="checkbox"/>	<input type="checkbox"/>	6-122
4	Traverse run: Deceleration time (C)	0.5	60.0	10.0 (s)	Set the time from the upper peak to the lower peak.	<input type="checkbox"/>	<input type="checkbox"/>	<input type="checkbox"/>	<input type="checkbox"/>	6-122
5	Traverse run: Deviated traverse (X)	0.0	20.0	10.0 (%)	When sequence input: S0 is ON, the center frequency will increase by the set amount.	<input type="checkbox"/>	<input type="checkbox"/>	<input type="checkbox"/>	<input type="checkbox"/>	6-122
6	Traverse run: Deviated traverse (Y)	0.0	20.0	10.0 (%)	When sequence input: S1 is ON, the center frequency will decrease by the set amount.	<input type="checkbox"/>	<input type="checkbox"/>	<input type="checkbox"/>	<input type="checkbox"/>	6-122
B46 – External brake control										
0	External brake selection (External brake selection)	111.	222.	111.	f0 = External brake function selection =1: OFF =2: ON f1= IDET interlock =1: OFF =2: ON f2 = Acceleration wait time =1: Program frequency output =2: DC brake output	<input type="checkbox"/>	<input type="checkbox"/>	<input type="checkbox"/>	<input type="checkbox"/>	6-124
1	Brake release wait time (LB) (External brake selection)	0.00	2.50	0.00 (s)	Set the wait time from the RUN command to the brake release command.	<input type="checkbox"/>	<input type="checkbox"/>	<input type="checkbox"/>	<input type="checkbox"/>	6-124
2	Acceleration start wait time (BL) (External brake selection)	0.00	2.50	0.00 (s)	Set the wait time from the point the brakes are released until the motor accelerates. If there is a brake answer (MBRK_ans), set from answer, and if none, set time from command.	<input type="checkbox"/>	<input type="checkbox"/>	<input type="checkbox"/>	<input type="checkbox"/>	6-124
3	Brake engage wait time (DB) (External brake selection)	0.00	2.50	0.00 (s)	Set the wait time (cumulative) from the point the frequency (speed) command value reaches the zero speed setting or below until the brake is engaged.	<input type="checkbox"/>	<input type="checkbox"/>	<input type="checkbox"/>	<input type="checkbox"/>	6-124
4	RUN error judgment time when engaging brake (External brake selection)	0.0	25.0	0.0 (s)	A fault stoppage occurs if ON for the RUN setting time or longer when engaging the brake. Error judgment is turned OFF at 0.00.	<input type="checkbox"/>	<input type="checkbox"/>	<input type="checkbox"/>	<input type="checkbox"/>	6-124
5	Brake answer error judgment time (External brake selection)	0.0	25.0	0.0 (s)	The brake command and brake answer do not match for the set time or longer, and a fault stoppage occurs. Error judgment is turned OFF at 0.00.	<input type="checkbox"/>	<input type="checkbox"/>	<input type="checkbox"/>	<input type="checkbox"/>	6-124
B47 – Simple ASR control										
0	Simple ASR control selection	11.	22.	21.	f0: Simple ASR selection =1: OFF =2: ON f1: Integral mask processing when accelerating / decelerating =1: OFF =2: ON	<input type="checkbox"/>	<input type="checkbox"/>	<input type="checkbox"/>	<input type="checkbox"/>	6-126
1	Simple ASR proportional gain	0.00	10.00	0.10	Set with response for machine time constant of 1s.	<input type="checkbox"/>	<input type="checkbox"/>	<input type="checkbox"/>	<input type="checkbox"/>	6-126
2	Simple ASR integral time constant	0.00	10.00	1.00 (s)	Set the simple ASR integral time constant.	<input type="checkbox"/>	<input type="checkbox"/>	<input type="checkbox"/>	<input type="checkbox"/>	6-126
3	Proportional variation rate limit	0.01	50.00	1.00 (%)	Set the proportional variation rate control value.	<input type="checkbox"/>	<input type="checkbox"/>	<input type="checkbox"/>	<input type="checkbox"/>	6-126
4	Compensation torque limiter	0.1	300.0	100.0 (%)	Set the slippage compensation limit value.	<input type="checkbox"/>	<input type="checkbox"/>	<input type="checkbox"/>	<input type="checkbox"/>	6-126
5	Simple ASR pole count	2.	32.	4.	Set the motor pole count.	<input type="checkbox"/>	<input type="checkbox"/>	<input type="checkbox"/>	<input type="checkbox"/>	6-126
6	Simple ASR pulse count	30.	10000.	1000.	Set the encoder pulse count.	<input type="checkbox"/>	<input type="checkbox"/>	<input type="checkbox"/>	<input type="checkbox"/>	6-126

6. Control Functions and Parameter Settings

Block-B parameters (S/W option constants) list

No.	Parameter	Min.	Max.	Default (Unit)	Function	Application				Ref. page
						Vf	VEC	PM	RWE	
B50 – Pattern run step-0										
0	Mode (Pattern run step-0)	0.	2.	0.	= 0: Stop = 1: Forward run = 2: Reverse run	<input type="checkbox"/>	<input type="checkbox"/>	<input type="checkbox"/>	<input type="checkbox"/>	6-127
1	Frequency (speed) (Pattern run step-0)	0.00	100.00	10.00 (%)	Set the step 0 frequency. 100% is the max. frequency (speed).	<input type="checkbox"/>	<input type="checkbox"/>	<input type="checkbox"/>	<input type="checkbox"/>	6-127
2	Time (Pattern run step-0)	0.1	6000.0	1.0 (s)	Set the time for operating at this step.	<input type="checkbox"/>	<input type="checkbox"/>	<input type="checkbox"/>	<input type="checkbox"/>	6-127
B51 – Pattern run step-1										
0	Mode (Pattern run step-1)	0.	2.	0.	= 0: Stop = 1: Forward run = 2: Reverse run	<input type="checkbox"/>	<input type="checkbox"/>	<input type="checkbox"/>	<input type="checkbox"/>	6-127
1	Frequency (speed) (Pattern run step-1)	0.00	100.00	10.00 (%)	Set the step 1 frequency. 100% is the max. frequency (speed).	<input type="checkbox"/>	<input type="checkbox"/>	<input type="checkbox"/>	<input type="checkbox"/>	6-127
2	Time (Pattern run step-1)	0.1	6000.0	1.0 (s)	Set the time for operating at this step.	<input type="checkbox"/>	<input type="checkbox"/>	<input type="checkbox"/>	<input type="checkbox"/>	6-127
B52 – Pattern run step-2										
0	Mode (Pattern run step-2)	0.	3.	0.	= 0: Stop = 1: Forward run = 2: Reverse run =3: Return	<input type="checkbox"/>	<input type="checkbox"/>	<input type="checkbox"/>	<input type="checkbox"/>	6-127
1	Frequency (speed) (Pattern run step-2)	0.00	100.00	10.00 (%)	Set the step 2 frequency. 100% is the max. frequency (speed).	<input type="checkbox"/>	<input type="checkbox"/>	<input type="checkbox"/>	<input type="checkbox"/>	6-127
2	Time (Pattern run step-2)	0.1	6000.0	1.0 (s)	Set the time for operating at this step.	<input type="checkbox"/>	<input type="checkbox"/>	<input type="checkbox"/>	<input type="checkbox"/>	6-127
3	Return destination step (Pattern run step-2)	0.	1.	0.	If a value other than 0 is set, the operation will start from the designated step No. once this step is finished.	<input type="checkbox"/>	<input type="checkbox"/>	<input type="checkbox"/>	<input type="checkbox"/>	6-127
B53 – Pattern run step-3										
0	Mode (Pattern run step-3)	0.	3.	0.	= 0: Stop = 1: Forward run = 2: Reverse run =3: Return	<input type="checkbox"/>	<input type="checkbox"/>	<input type="checkbox"/>	<input type="checkbox"/>	6-127
1	Frequency (speed) (Pattern run step-3)	0.00	100.00	10.00 (%)	Set the step 3 frequency. 100% is the max. frequency (speed).	<input type="checkbox"/>	<input type="checkbox"/>	<input type="checkbox"/>	<input type="checkbox"/>	6-127
2	Time (Pattern run step-3)	0.1	6000.0	1.0 (s)	Set the time for operating at this step.	<input type="checkbox"/>	<input type="checkbox"/>	<input type="checkbox"/>	<input type="checkbox"/>	6-127
3	Return destination step (Pattern run step-3)	0.	2.	0.	If a value other than 0 is set, the operation will start from the designated step No. once this step is finished.	<input type="checkbox"/>	<input type="checkbox"/>	<input type="checkbox"/>	<input type="checkbox"/>	6-127
B54 – Pattern run step-4										
0	Mode (Pattern run step-4)	0.	3.	0.	= 0: Stop = 1: Forward run = 2: Reverse run =3: Return	<input type="checkbox"/>	<input type="checkbox"/>	<input type="checkbox"/>	<input type="checkbox"/>	6-127
1	Frequency (speed) (Pattern run step-4)	0.00	100.00	10.00 (%)	Set the step 4 frequency. 100% is the max. frequency (speed).	<input type="checkbox"/>	<input type="checkbox"/>	<input type="checkbox"/>	<input type="checkbox"/>	6-127
2	Time (Pattern run step-4)	0.1	6000.0	1.0 (s)	Set the time for operating at this step.	<input type="checkbox"/>	<input type="checkbox"/>	<input type="checkbox"/>	<input type="checkbox"/>	6-127
3	Return destination step (Pattern run step-4)	0.	3.	0.	If a value other than 0 is set, the operation will start from the designated step No. once this step is finished.	<input type="checkbox"/>	<input type="checkbox"/>	<input type="checkbox"/>	<input type="checkbox"/>	6-127
B55 – Pattern run step-5										
0	Mode (Pattern run step-5)	0.	3.	0.	= 0: Stop = 1: Forward run = 2: Reverse run =3: Return	<input type="checkbox"/>	<input type="checkbox"/>	<input type="checkbox"/>	<input type="checkbox"/>	6-127
1	Frequency (speed) (Pattern run step-5)	0.00	100.00	10.00 (%)	Set the step 5 frequency. 100% is the max. frequency (speed).	<input type="checkbox"/>	<input type="checkbox"/>	<input type="checkbox"/>	<input type="checkbox"/>	6-127
2	Time (Pattern run step-5)	0.1	6000.0	1.0 (s)	Set the time for operating at this step.	<input type="checkbox"/>	<input type="checkbox"/>	<input type="checkbox"/>	<input type="checkbox"/>	6-127
3	Return destination step (Pattern run step-5)	0.	4.	0.	If a value other than 0 is set, the operation will start from the designated step No. once this step is finished.	<input type="checkbox"/>	<input type="checkbox"/>	<input type="checkbox"/>	<input type="checkbox"/>	6-127

6. Control Functions and Parameter Settings

Block-B parameters (S/W option constants) list

No.	Parameter	Min.	Max.	Default (Unit)	Function	Application				Ref. page
						Vf	VEC	PM	RWE	
B56 – Pattern run step-6										
0	Mode (Pattern run step-6)	0.	3.	0.	= 0: Stop = 1: Forward run = 2: Reverse run =3: Return	<input type="radio"/>	<input type="radio"/>	<input type="radio"/>	<input type="radio"/>	6-127
1	Frequency (speed) (Pattern run step-6)	0.00	100.00	10.00 (%)	Set the step 6 frequency. 100% is the max. frequency (speed).	<input type="radio"/>	<input type="radio"/>	<input type="radio"/>	<input type="radio"/>	6-127
2	Time (Pattern run step-6)	0.1	6000.0	1.0 (s)	Set the time for operating at this step.	<input type="radio"/>	<input type="radio"/>	<input type="radio"/>	<input type="radio"/>	6-127
3	Return destination step (Pattern run step-6)	0.	5.	0.	If a value other than 0 is set, the operation will start from the designated step No. once this step is finished.	<input type="radio"/>	<input type="radio"/>	<input type="radio"/>	<input type="radio"/>	6-127
B57 – Pattern run step-7										
0	Mode (Pattern run step-7)	0.	3.	0.	= 0: Stop = 1: Forward run = 2: Reverse run =3: Return	<input type="radio"/>	<input type="radio"/>	<input type="radio"/>	<input type="radio"/>	6-127
1	Frequency (speed) (Pattern run step-7)	0.00	100.00	10.00 (%)	Set the step 7 frequency. 100% is the max. frequency (speed).	<input type="radio"/>	<input type="radio"/>	<input type="radio"/>	<input type="radio"/>	6-127
2	Time (Pattern run step-7)	0.1	6000.0	1.0 (s)	Set the time for operating at this step.	<input type="radio"/>	<input type="radio"/>	<input type="radio"/>	<input type="radio"/>	6-127
3	Return destination step (Pattern run step-7)	0.	6.	0.	If a value other than 0 is set, the operation will start from the designated step No. once this step is finished.	<input type="radio"/>	<input type="radio"/>	<input type="radio"/>	<input type="radio"/>	6-127
B58 – Pattern run step-8										
0	Mode (Pattern run step-8)	0.	3.	0.	= 0: Stop = 1: Forward run = 2: Reverse run =3: Return	<input type="radio"/>	<input type="radio"/>	<input type="radio"/>	<input type="radio"/>	6-127
1	Frequency (speed) (Pattern run step-8)	0.00	100.00	10.00 (%)	Set the step 8 frequency. 100% is the max. frequency (speed).	<input type="radio"/>	<input type="radio"/>	<input type="radio"/>	<input type="radio"/>	6-127
2	Time (Pattern run step-8)	0.1	6000.0	1.0 (s)	Set the time for operating at this step.	<input type="radio"/>	<input type="radio"/>	<input type="radio"/>	<input type="radio"/>	6-127
3	Return destination step (Pattern run step-8)	0.	7.	0.	If a value other than 0 is set, the operation will start from the designated step No. once this step is finished.	<input type="radio"/>	<input type="radio"/>	<input type="radio"/>	<input type="radio"/>	6-127
B59 – Pattern run step-9										
0	Mode (Pattern run step-9)	0.	3.	0.	= 0: Stop = 1: Forward run = 2: Reverse run =3: Return	<input type="radio"/>	<input type="radio"/>	<input type="radio"/>	<input type="radio"/>	6-127
1	Frequency (speed) (Pattern run step-9)	0.00	100.00	10.00 (%)	Set the step 9 frequency. 100% is the max. frequency (speed).	<input type="radio"/>	<input type="radio"/>	<input type="radio"/>	<input type="radio"/>	6-127
2	Time (Pattern run step-9)	0.1	6000.0	1.0 (s)	Set the time for operating at this step.	<input type="radio"/>	<input type="radio"/>	<input type="radio"/>	<input type="radio"/>	6-127
3	Return destination step (Pattern run step-9)	0.	8.	0.	If a value other than 0 is set, the operation will start from the designated step No. once this step is finished.	<input type="radio"/>	<input type="radio"/>	<input type="radio"/>	<input type="radio"/>	6-127
B60 – Spinning frame operation setting										
0	STP function selection (Spinning frame operation setting)	11.	22.	11.	f0 = STP function selection = 1: Not selected =2: Selected f1 = Operation mode after final step selection = 1: Operation stop = 2: FRQ SP operation	<input type="radio"/>				6-129
1	STP0 step count (Spinning frame operation setting)	0.	14.	14.	Set the step number to STP0.	<input type="radio"/>			<input type="radio"/>	6-129
2	STP1 step count (Spinning frame operation setting)	0.	14.	14.	Set the step number to STP1.	<input type="radio"/>			<input type="radio"/>	6-129
3	STP2 step count (Spinning frame operation setting)	0.	14.	14.	Set the step number to STP2.	<input type="radio"/>			<input type="radio"/>	6-129
4	STP3 step count (Spinning frame operation setting)	0.	14.	14.	Set the step number to STP3.	<input type="radio"/>			<input type="radio"/>	6-129
5	Doff-End alarm time (Spinning frame operation setting)	0.1	3000.0	1.0 (%)	Outputs alarm signal for the set time from completion of the final step until directly before stoppage.	<input type="radio"/>			<input type="radio"/>	6-129

6. Control Functions and Parameter Settings

Block-B parameters (S/W option constants) list

No.	Parameter	Min.	Max.	Default (Unit)	Function	Application				Ref. page
						Vf	VEC	PM	RWE	
B60 – Spinning frame operation setting										
6	STP time unit setting (Spinning frame operation setting)	1.	2.	1.	1 = ×1, 2 = ×10 This is valid for the STP time (B63, 64, 67, 68, 71, 72, 75, 76) and Doff-End alarm time (B60-5).	○			○	6-129
7	Hank count gain (Spinning frame operation setting)	0.001	30.000	1.000	This is the Hank count calculation gain.	○			○	6-129
8	Hank count gain unit (Spinning frame operation setting)	1.	3.	1.	=1: ×1.0, =2: ×0.1, =3: ×10	○			○	6-129
9	FRQ_SP frequency setting (Spinning frame operation setting)	0.00	100.00	10.00 (%)	Set the frequency after the step is completed. This is valid when B60-0[f1]=2.	○			○	6-129
B61 – STP0 frequency										
0	STP0 frequency 0	0.00	100.00	10.00 (%)	Set the STP0 step 0 frequency.	○			○	6-129
1	STP0 frequency 1	0.00	100.00	10.00 (%)	Set the STP0 step 1 frequency.	○			○	6-129
2	STP0 frequency 2	0.00	100.00	10.00 (%)	Set the STP0 step 2 frequency.	○			○	6-129
3	STP0 frequency 3	0.00	100.00	10.00 (%)	Set the STP0 step 3 frequency.	○			○	6-129
4	STP0 frequency 4	0.00	100.00	10.00 (%)	Set the STP0 step 4 frequency.	○			○	6-129
5	STP0 frequency 5	0.00	100.00	10.00 (%)	Set the STP0 step 5 frequency.	○			○	6-129
6	STP0 frequency 6	0.00	100.00	10.00 (%)	Set the STP0 step 6 frequency.	○			○	6-129
7	STP0 frequency 7	0.00	100.00	10.00 (%)	Set the STP0 step 7 frequency.	○			○	6-129
B62 – STP0 frequency										
0	STP0 frequency 8	0.00	100.00	10.00 (%)	Set the STP0 step 8 frequency.	○			○	6-129
1	STP0 frequency 9	0.00	100.00	10.00 (%)	Set the STP0 step 9 frequency.	○			○	6-129
2	STP0 frequency 10	0.00	100.00	10.00 (%)	Set the STP0 step 10 frequency.	○			○	6-129
3	STP0 frequency 11	0.00	100.00	10.00 (%)	Set the STP0 step 11 frequency.	○			○	6-129
4	STP0 frequency 12	0.00	100.00	10.00 (%)	Set the STP0 step 12 frequency.	○			○	6-129
5	STP0 frequency 13	0.00	100.00	10.00 (%)	Set the STP0 step 13 frequency.	○			○	6-129
6	STP0 frequency 14	0.00	100.00	10.00 (%)	Set the STP0 step 14 frequency.	○			○	6-129
B63 – STP0 time										
0	STP0 time 0	0.1	6000.0	1.0 (s)	Set the STP0 step 0 time.	○			○	6-129
1	STP0 time 1	0.1	6000.0	1.0 (s)	Set the STP0 step 1 time.	○			○	6-129
2	STP0 time 2	0.1	6000.0	1.0 (s)	Set the STP0 step 2 time.	○			○	6-129
3	STP0 time 3	0.1	6000.0	1.0 (s)	Set the STP0 step 3 time.	○			○	6-129
4	STP0 time 4	0.1	6000.0	1.0 (s)	Set the STP0 step 4 time.	○			○	6-129
5	STP0 time 5	0.1	6000.0	1.0 (s)	Set the STP0 step 5 time.	○			○	6-129
6	STP0 time 6	0.1	6000.0	1.0 (s)	Set the STP0 step 6 time.	○			○	6-129
7	STP0 time 7	0.1	6000.0	1.0 (s)	Set the STP0 step 7 time.	○			○	6-129

6. Control Functions and Parameter Settings

Block-B parameters (S/W option constants) list

No.	Parameter	Min.	Max.	Default (Unit)	Function	Application				Ref. page
						V/F	VEC	PM	RWE	
B64 – STP0 time										
0	STP0 time 8	0.1	6000.0	1.0 (s)	Set the STP0 step 8 time.	<input type="radio"/>	<input type="radio"/>	<input type="radio"/>	<input type="radio"/>	6-129
1	STP0 time 9	0.1	6000.0	1.0 (s)	Set the STP0 step 9 time.	<input type="radio"/>	<input type="radio"/>	<input type="radio"/>	<input type="radio"/>	6-129
2	STP0 time 10	0.1	6000.0	1.0 (s)	Set the STP0 step 10 time.	<input type="radio"/>	<input type="radio"/>	<input type="radio"/>	<input type="radio"/>	6-129
3	STP0 time 11	0.1	6000.0	1.0 (s)	Set the STP0 step 11 time.	<input type="radio"/>	<input type="radio"/>	<input type="radio"/>	<input type="radio"/>	6-129
4	STP0 time 12	0.1	6000.0	1.0 (s)	Set the STP0 step 12 time.	<input type="radio"/>	<input type="radio"/>	<input type="radio"/>	<input type="radio"/>	6-129
5	STP0 time 13	0.1	6000.0	1.0 (s)	Set the STP0 step 13 time.	<input type="radio"/>	<input type="radio"/>	<input type="radio"/>	<input type="radio"/>	6-129
6	STP0 time 14	0.1	6000.0	1.0 (s)	Set the STP0 step 14 time.	<input type="radio"/>	<input type="radio"/>	<input type="radio"/>	<input type="radio"/>	6-129
B65 – STP1 frequency										
0	STP1 frequency 0	0.00	100.00	10.00 (%)	Set the STP1 step 0 frequency.	<input type="radio"/>	<input type="radio"/>	<input type="radio"/>	<input type="radio"/>	6-129
1	STP1 frequency 1	0.00	100.00	10.00 (%)	Set the STP1 step 1 frequency.	<input type="radio"/>	<input type="radio"/>	<input type="radio"/>	<input type="radio"/>	6-129
2	STP1 frequency 2	0.00	100.00	10.00 (%)	Set the STP1 step 2 frequency.	<input type="radio"/>	<input type="radio"/>	<input type="radio"/>	<input type="radio"/>	6-129
3	STP1 frequency 3	0.00	100.00	10.00 (%)	Set the STP1 step 3 frequency.	<input type="radio"/>	<input type="radio"/>	<input type="radio"/>	<input type="radio"/>	6-129
4	STP1 frequency 4	0.00	100.00	10.00 (%)	Set the STP1 step 4 frequency.	<input type="radio"/>	<input type="radio"/>	<input type="radio"/>	<input type="radio"/>	6-129
5	STP1 frequency 5	0.00	100.00	10.00 (%)	Set the STP1 step 5 frequency.	<input type="radio"/>	<input type="radio"/>	<input type="radio"/>	<input type="radio"/>	6-129
6	STP1 frequency 6	0.00	100.00	10.00 (%)	Set the STP1 step 6 frequency.	<input type="radio"/>	<input type="radio"/>	<input type="radio"/>	<input type="radio"/>	6-129
7	STP1 frequency 7	0.00	100.00	10.00 (%)	Set the STP1 step 7 frequency.	<input type="radio"/>	<input type="radio"/>	<input type="radio"/>	<input type="radio"/>	6-129
B66 – STP1 frequency										
0	STP1 frequency 8	0.00	100.00	10.00 (%)	Set the STP1 step 8 frequency.	<input type="radio"/>	<input type="radio"/>	<input type="radio"/>	<input type="radio"/>	6-129
1	STP1 frequency 9	0.00	100.00	10.00 (%)	Set the STP1 step 9 frequency.	<input type="radio"/>	<input type="radio"/>	<input type="radio"/>	<input type="radio"/>	6-129
2	STP1 frequency 10	0.00	100.00	10.00 (%)	Set the STP1 step 10 frequency.	<input type="radio"/>	<input type="radio"/>	<input type="radio"/>	<input type="radio"/>	6-129
3	STP1 frequency 11	0.00	100.00	10.00 (%)	Set the STP1 step 11 frequency.	<input type="radio"/>	<input type="radio"/>	<input type="radio"/>	<input type="radio"/>	6-129
4	STP1 frequency 12	0.00	100.00	10.00 (%)	Set the STP1 step 12 frequency.	<input type="radio"/>	<input type="radio"/>	<input type="radio"/>	<input type="radio"/>	6-129
5	STP1 frequency 13	0.00	100.00	10.00 (%)	Set the STP1 step 13 frequency.	<input type="radio"/>	<input type="radio"/>	<input type="radio"/>	<input type="radio"/>	6-129
6	STP1 frequency 14	0.00	100.00	10.00 (%)	Set the STP1 step 14 frequency.	<input type="radio"/>	<input type="radio"/>	<input type="radio"/>	<input type="radio"/>	6-129
B67 – STP1 time										
0	STP1 time 0	0.1	6000.0	1.0 (s)	Set the STP1 step 0 time.	<input type="radio"/>	<input type="radio"/>	<input type="radio"/>	<input type="radio"/>	6-129
1	STP1 time 1	0.1	6000.0	1.0 (s)	Set the STP1 step 1 time.	<input type="radio"/>	<input type="radio"/>	<input type="radio"/>	<input type="radio"/>	6-129
2	STP1 time 2	0.1	6000.0	1.0 (s)	Set the STP1 step 2 time.	<input type="radio"/>	<input type="radio"/>	<input type="radio"/>	<input type="radio"/>	6-129
3	STP1 time 3	0.1	6000.0	1.0 (s)	Set the STP1 step 3 time.	<input type="radio"/>	<input type="radio"/>	<input type="radio"/>	<input type="radio"/>	6-129
4	STP1 time 4	0.1	6000.0	1.0 (s)	Set the STP1 step 4 time.	<input type="radio"/>	<input type="radio"/>	<input type="radio"/>	<input type="radio"/>	6-129
5	STP1 time 5	0.1	6000.0	1.0 (s)	Set the STP1 step 5 time.	<input type="radio"/>	<input type="radio"/>	<input type="radio"/>	<input type="radio"/>	6-129
6	STP1 time 6	0.1	6000.0	1.0 (s)	Set the STP1 step 6 time.	<input type="radio"/>	<input type="radio"/>	<input type="radio"/>	<input type="radio"/>	6-129
7	STP1 time 7	0.1	6000.0	1.0 (s)	Set the STP1 step 7 time.	<input type="radio"/>	<input type="radio"/>	<input type="radio"/>	<input type="radio"/>	6-129

6. Control Functions and Parameter Settings

Block-B parameters (S/W option constants) list

No.	Parameter	Min.	Max.	Default (Unit)	Function	Application				Ref. page
						V/F	VEC	PM	RWE	
B68 – STP1 time										
0	STP1 time 8	0.1	6000.0	1.0 (s)	Set the STP1 step 8 time.	<input type="radio"/>			<input type="radio"/>	6-129
1	STP1 time 9	0.1	6000.0	1.0 (s)	Set the STP1 step 9 time.	<input type="radio"/>			<input type="radio"/>	6-129
2	STP1 time 10	0.1	6000.0	1.0 (s)	Set the STP1 step 10 time.	<input type="radio"/>			<input type="radio"/>	6-129
3	STP1 time 11	0.1	6000.0	1.0 (s)	Set the STP1 step 11 time.	<input type="radio"/>			<input type="radio"/>	6-129
4	STP1 time 12	0.1	6000.0	1.0 (s)	Set the STP1 step 12 time.	<input type="radio"/>			<input type="radio"/>	6-129
5	STP1 time 13	0.1	6000.0	1.0 (s)	Set the STP1 step 13 time.	<input type="radio"/>			<input type="radio"/>	6-129
6	STP1 time 14	0.1	6000.0	1.0 (s)	Set the STP1 step 14 time.	<input type="radio"/>			<input type="radio"/>	6-129
B69 – STP2 frequency										
0	STP2 frequency 0	0.00	100.00	10.00 (%)	Set the STP2 step 0 frequency.	<input type="radio"/>			<input type="radio"/>	6-129
1	STP2 frequency 1	0.00	100.00	10.00 (%)	Set the STP2 step 1 frequency.	<input type="radio"/>			<input type="radio"/>	6-129
2	STP2 frequency 2	0.00	100.00	10.00 (%)	Set the STP2 step 2 frequency.	<input type="radio"/>			<input type="radio"/>	6-129
3	STP2 frequency 3	0.00	100.00	10.00 (%)	Set the STP2 step 3 frequency.	<input type="radio"/>			<input type="radio"/>	6-129
4	STP2 frequency 4	0.00	100.00	10.00 (%)	Set the STP2 step 4 frequency.	<input type="radio"/>			<input type="radio"/>	6-129
5	STP2 frequency 5	0.00	100.00	10.00 (%)	Set the STP2 step 5 frequency.	<input type="radio"/>			<input type="radio"/>	6-129
6	STP2 frequency 6	0.00	100.00	10.00 (%)	Set the STP2 step 6 frequency.	<input type="radio"/>			<input type="radio"/>	6-129
7	STP2 frequency 7	0.00	100.00	10.00 (%)	Set the STP2 step 7 frequency.	<input type="radio"/>			<input type="radio"/>	6-129
B70 – STP2 frequency										
0	STP2 frequency 8	0.00	100.00	10.00 (%)	Set the STP2 step 8 frequency.	<input type="radio"/>			<input type="radio"/>	6-129
1	STP2 frequency 9	0.00	100.00	10.00 (%)	Set the STP2 step 9 frequency.	<input type="radio"/>			<input type="radio"/>	6-129
2	STP2 frequency 10	0.00	100.00	10.00 (%)	Set the STP2 step 10 frequency.	<input type="radio"/>			<input type="radio"/>	6-129
3	STP2 frequency 11	0.00	100.00	10.00 (%)	Set the STP2 step 11 frequency.	<input type="radio"/>			<input type="radio"/>	6-129
4	STP2 frequency 12	0.00	100.00	10.00 (%)	Set the STP2 step 12 frequency.	<input type="radio"/>			<input type="radio"/>	6-129
5	STP2 frequency 13	0.00	100.00	10.00 (%)	Set the STP2 step 13 frequency.	<input type="radio"/>			<input type="radio"/>	6-129
6	STP2 frequency 14	0.00	100.00	10.00 (%)	Set the STP2 step 14 frequency.	<input type="radio"/>			<input type="radio"/>	6-129
B71 – STP2 time										
0	STP2 time 0	0.1	6000.0	1.0 (s)	Set the STP2 step 0 time.	<input type="radio"/>			<input type="radio"/>	6-129
1	STP2 time 1	0.1	6000.0	1.0 (s)	Set the STP2 step 1 time.	<input type="radio"/>			<input type="radio"/>	6-129
2	STP2 time 2	0.1	6000.0	1.0 (s)	Set the STP2 step 2 time.	<input type="radio"/>			<input type="radio"/>	6-129
3	STP2 time 3	0.1	6000.0	1.0 (s)	Set the STP2 step 3 time.	<input type="radio"/>			<input type="radio"/>	6-129
4	STP2 time 4	0.1	6000.0	1.0 (s)	Set the STP2 step 4 time.	<input type="radio"/>			<input type="radio"/>	6-129
5	STP2 time 5	0.1	6000.0	1.0 (s)	Set the STP2 step 5 time.	<input type="radio"/>			<input type="radio"/>	6-129
6	STP2 time 6	0.1	6000.0	1.0 (s)	Set the STP2 step 6 time.	<input type="radio"/>			<input type="radio"/>	6-129
7	STP2 time 7	0.1	6000.0	1.0 (s)	Set the STP2 step 7 time.	<input type="radio"/>			<input type="radio"/>	6-129

6. Control Functions and Parameter Settings

Block-B parameters (S/W option constants) list

No.	Parameter	Min.	Max.	Default (Unit)	Function	Application				Ref. page
						V/F	VEC	PM	RWE	
B72 – STP2 time										
0	STP2 time 8	0.1	6000.0	1.0 (s)	Set the STP2 step 8 time.	<input type="radio"/>			<input type="radio"/>	6-129
1	STP2 time 9	0.1	6000.0	1.0 (s)	Set the STP2 step 9 time.	<input type="radio"/>			<input type="radio"/>	6-129
2	STP2 time 10	0.1	6000.0	1.0 (s)	Set the STP2 step 10 time.	<input type="radio"/>			<input type="radio"/>	6-129
3	STP2 time 11	0.1	6000.0	1.0 (s)	Set the STP2 step 11 time.	<input type="radio"/>			<input type="radio"/>	6-129
4	STP2 time 12	0.1	6000.0	1.0 (s)	Set the STP2 step 12 time.	<input type="radio"/>			<input type="radio"/>	6-129
5	STP2 time 13	0.1	6000.0	1.0 (s)	Set the STP2 step 13 time.	<input type="radio"/>			<input type="radio"/>	6-129
6	STP2 time 14	0.1	6000.0	1.0 (s)	Set the STP2 step 14 time.	<input type="radio"/>			<input type="radio"/>	6-129
B73 – STP3 frequency										
0	STP3 frequency 0	0.00	100.00	10.00 (%)	Set the STP3 step 0 frequency.	<input type="radio"/>			<input type="radio"/>	6-129
1	STP3 frequency 1	0.00	100.00	10.00 (%)	Set the STP3 step 1 frequency.	<input type="radio"/>			<input type="radio"/>	6-129
2	STP3 frequency 2	0.00	100.00	10.00 (%)	Set the STP3 step 2 frequency.	<input type="radio"/>			<input type="radio"/>	6-129
3	STP3 frequency 3	0.00	100.00	10.00 (%)	Set the STP3 step 3 frequency.	<input type="radio"/>			<input type="radio"/>	6-129
4	STP3 frequency 4	0.00	100.00	10.00 (%)	Set the STP3 step 4 frequency.	<input type="radio"/>			<input type="radio"/>	6-129
5	STP3 frequency 5	0.00	100.00	10.00 (%)	Set the STP3 step 5 frequency.	<input type="radio"/>			<input type="radio"/>	6-129
6	STP3 frequency 6	0.00	100.00	10.00 (%)	Set the STP3 step 6 frequency.	<input type="radio"/>			<input type="radio"/>	6-129
7	STP3 frequency 7	0.00	100.00	10.00 (%)	Set the STP3 step 7 frequency.	<input type="radio"/>			<input type="radio"/>	6-129
B74 – STP3 frequency										
0	STP3 frequency 8	0.00	100.00	10.00 (%)	Set the STP3 step 8 frequency.	<input type="radio"/>			<input type="radio"/>	6-129
1	STP3 frequency 9	0.00	100.00	10.00 (%)	Set the STP3 step 9 frequency.	<input type="radio"/>			<input type="radio"/>	6-129
2	STP3 frequency 10	0.00	100.00	10.00 (%)	Set the STP3 step 10 frequency.	<input type="radio"/>			<input type="radio"/>	6-129
3	STP3 frequency 11	0.00	100.00	10.00 (%)	Set the STP3 step 11 frequency.	<input type="radio"/>			<input type="radio"/>	6-129
4	STP3 frequency 12	0.00	100.00	10.00 (%)	Set the STP3 step 12 frequency.	<input type="radio"/>			<input type="radio"/>	6-129
5	STP3 frequency 13	0.00	100.00	10.00 (%)	Set the STP3 step 13 frequency.	<input type="radio"/>			<input type="radio"/>	6-129
6	STP3 frequency 14	0.00	100.00	10.00 (%)	Set the STP3 step 14 frequency.	<input type="radio"/>			<input type="radio"/>	6-129
B75 – STP3 time										
0	STP3 time 0	0.1	6000.0	1.0 (s)	Set the STP3 step 0 time.	<input type="radio"/>			<input type="radio"/>	6-129
1	STP3 time 1	0.1	6000.0	1.0 (s)	Set the STP3 step 1 time.	<input type="radio"/>			<input type="radio"/>	6-129
2	STP3 time 2	0.1	6000.0	1.0 (s)	Set the STP3 step 2 time.	<input type="radio"/>			<input type="radio"/>	6-129
3	STP3 time 3	0.1	6000.0	1.0 (s)	Set the STP3 step 3 time.	<input type="radio"/>			<input type="radio"/>	6-129
4	STP3 time 4	0.1	6000.0	1.0 (s)	Set the STP3 step 4 time.	<input type="radio"/>			<input type="radio"/>	6-129
5	STP3 time 5	0.1	6000.0	1.0 (s)	Set the STP3 step 5 time.	<input type="radio"/>			<input type="radio"/>	6-129
6	STP3 time 6	0.1	6000.0	1.0 (s)	Set the STP3 step 6 time.	<input type="radio"/>			<input type="radio"/>	6-129
7	STP3 time 7	0.1	6000.0	1.0 (s)	Set the STP3 step 7 time.	<input type="radio"/>			<input type="radio"/>	6-129

6. Control Functions and Parameter Settings

Block-B parameters (S/W option constants) list

No.	Parameter	Min.	Max.	Default (Unit)	Function	Application				Ref. page
						V/f	VEC	PM	RWE	
B76 – STP3 time										
0	STP3 time 8	0.1	6000.0	1.0 (s)	Set the STP3 step 8 time.	○			○	6-129
1	STP3 time 9	0.1	6000.0	1.0 (s)	Set the STP3 step 9 time.	○			○	6-129
2	STP3 time 10	0.1	6000.0	1.0 (s)	Set the STP3 step 10 time.	○			○	6-129
3	STP3 time 11	0.1	6000.0	1.0 (s)	Set the STP3 step 11 time.	○			○	6-129
4	STP3 time 12	0.1	6000.0	1.0 (s)	Set the STP3 step 12 time.	○			○	6-129
5	STP3 time 13	0.1	6000.0	1.0 (s)	Set the STP3 step 13 time.	○			○	6-129
6	STP3 time 14	0.1	6000.0	1.0 (s)	Set the STP3 step 14 time.	○			○	6-129

6. Control Functions and Parameter Settings

6-4 Block-C parameters

The Block-C parameters are divided into the basic functions, extended functions and hardware option functions.

V/f : Indicates parameters that apply for V/f control (constant torque, variable torque) (C30-0: f0 = 1).

VEC : Indicates parameters that apply for IM speed sensor-less vector control and IM speed vector control with sensor (C30-0: f0 = 2, 3).

PM : Indicates parameters that apply for control mode with PM motor sensor (C30-0: f0 = 4).

RWE : Displays the parameters that can be changed during operation.

Reference page: The number of the page providing detailed explanations is indicated.

Block-C parameters list

No.	Parameter	Min.	Max.	Default (Unit)	Function	Application				Ref. page
						V/f	VEC	PM	RWE	
C00 – Control methods										
0	Run command method	1.	3.	1.	Run command method is set. = 1: F·RUN, R·RUN = 2: RUN, REV = 3: Self hold (Pulse inputs for F·RUN and R·RUN)	○	○	○		6-133
1	Run/stop methods	1.	2.	2.	Set the stopping method for RUN operation. = 1: Coast to stop = 2: Ramp down to stop	○	○	○		6-134
2	Jog stop method	1.	2.	2.	Set the stopping method for JOG operation. = 1: Coast to stop = 2: Ramp down to stop	○	○	○		6-134
3	Emergency stop (EMS) input logic	1.	2.	1.	Emergency stop input logic is set. = 1: Close to stop = 2: Open to stop	○	○	○		6-134
4	Emergency stop (EMS) mode	1.	3.	1.	Set the stopping method for the emergency stop. = 1: Coast to stop without a fault output = 2: Coast to stop with a fault output = 3: Ramp down to stop	○	○	○		6-134
5	Control source switchover method (J1 setting)	1.	2.	1.	Set whether to validate the remote auxiliary operation sequence for the local operation mode. = 1: Disables = 2: Enables	○	○	○		6-135
6	Control source switchover method (J2 setting)	1.	2.	1.	Select the No. of auxiliary operation sequence input points when the COP command is ON. = 1: Terminal block input = 2: Serial input	○	○	○		6-135
7	Run contact output condition selection	1.	2.	1.	The conditions for turning the sequence RUN output ON are set. = 1: ON at pre-excitation = 2: OFF at pre-excitation	○	○	○		
C01 – Start/stop frequency										
0	Start frequency	0.10	Fmax or 60.00	1.00 (Hz)	When RUN is started, operation starts from this frequency.	○			○	6-86
1	Stop frequency (DC brake start)	0.10	Fmax or 60.00	1.00 (Hz)	The DC brakes are applied when the output frequency value is less than this frequency value.	○			○	6-86

6. Control Functions and Parameter Settings

Block-C parameters list

No.	Parameter	Min.	Max.	Default (Unit)	Function	Application				Ref. page
						V/f	VEC	PM	RWE	
C02 – Various setting input selection										
0	Speed setting input points selection	1.	5.	4.	= 1: Analog fixed = 2: Serial/parallel fixed = 3: Panel fixed = 4: Sequence = 5: Pulse train input fixed	<input type="radio"/>	<input type="radio"/>	<input type="radio"/>		6-135
1	Traverse center frequency input points selection	1.	5.	3.	= 1: Analog fixed = 2: Analog fixed = 3: Panel fixed = 4: Sequence = 5: Pulse train input fixed	<input type="radio"/>	<input type="radio"/>	<input type="radio"/>		6-135
2	Torque setting input points selection	1.	5.	3.	= 1: Analog fixed = 2: Serial fixed = 3: Panel fixed = 4: Sequence = 5: Pulse train input fixed		<input type="radio"/>	<input type="radio"/>		6-135
3	Torque ratio 1 setting input points selection	2.	4.	3.	= 2: Serial fixed = 3: Panel fixed = 4: Sequence		<input type="radio"/>	<input type="radio"/>		6-135
4	Torque bias 1 setting input points selection	1.	4.	3.	= 1: Analog fixed = 2: Serial fixed = 3: Panel fixed = 4: Sequence		<input type="radio"/>	<input type="radio"/>		6-135
5	Torque ratio 2 setting input points selection	2.	4.	3.	= 2: Serial fixed = 3: Panel fixed = 4: Sequence		<input type="radio"/>	<input type="radio"/>		6-135
6	Drive/regenerative torque limit input points selection	1.	4.	4.	= 1: Analog fixed = 2: Serial fixed = 3: Sequence = 4: Sequence		<input type="radio"/>	<input type="radio"/>		6-135
7	ASR response input points selection	2.	4.	3.	= 2: Serial fixed = 3: Panel fixed = 4: Sequence		<input type="radio"/>	<input type="radio"/>		6-135
8	Machine time constant input points selection	2.	4.	3.	= 2: Serial fixed = 3: Panel fixed = 4: Sequence		<input type="radio"/>	<input type="radio"/>		6-135

6. Control Functions and Parameter Settings

Block-C parameters list

No.	Parameter	Min.	Max.	Default (Unit)	Function	Application				Ref. page																																																										
						Vf	VEC	PM	RWE																																																											
C03 – Sequence input terminal function – 1																																																																				
0	F-RUN Forward run	-11.	16.	1.	<table border="1" style="width: 100%; border-collapse: collapse;"> <thead> <tr> <th>Value</th> <th>Input terminal</th> </tr> </thead> <tbody> <tr> <td>-11</td> <td>PSI11</td> </tr> <tr> <td>-10</td> <td>PSI10</td> </tr> <tr> <td>-9</td> <td>PSI9</td> </tr> <tr> <td>-8</td> <td>PSI8</td> </tr> <tr> <td>-7</td> <td>PSI7</td> </tr> <tr> <td>-6</td> <td>PSI6</td> </tr> <tr> <td>-5</td> <td>PSI5</td> </tr> <tr> <td>-4</td> <td>PSI4</td> </tr> <tr> <td>-3</td> <td>PSI3</td> </tr> <tr> <td>-2</td> <td>PSI2</td> </tr> <tr> <td>-1</td> <td>PSI1</td> </tr> <tr> <td>0</td> <td>OFF fixed</td> </tr> <tr> <td>1</td> <td>PSI1</td> </tr> <tr> <td>2</td> <td>PSI2</td> </tr> <tr> <td>3</td> <td>PSI3</td> </tr> <tr> <td>4</td> <td>PSI4</td> </tr> <tr> <td>5</td> <td>PSI5</td> </tr> <tr> <td>6</td> <td>PSI6</td> </tr> <tr> <td>7</td> <td>PSI7</td> </tr> <tr> <td>8</td> <td>PSI8</td> </tr> <tr> <td>9</td> <td>PSI9</td> </tr> <tr> <td>10</td> <td>PSI10</td> </tr> <tr> <td>11</td> <td>PSI11</td> </tr> <tr> <td>12</td> <td>PLC1</td> </tr> <tr> <td>13</td> <td>PLC2</td> </tr> <tr> <td>14</td> <td>PLC3</td> </tr> <tr> <td>15</td> <td>PLC4</td> </tr> <tr> <td>16</td> <td>ON fixed</td> </tr> </tbody> </table>	Value	Input terminal	-11	PSI11	-10	PSI10	-9	PSI9	-8	PSI8	-7	PSI7	-6	PSI6	-5	PSI5	-4	PSI4	-3	PSI3	-2	PSI2	-1	PSI1	0	OFF fixed	1	PSI1	2	PSI2	3	PSI3	4	PSI4	5	PSI5	6	PSI6	7	PSI7	8	PSI8	9	PSI9	10	PSI10	11	PSI11	12	PLC1	13	PLC2	14	PLC3	15	PLC4	16	ON fixed	<input type="checkbox"/>	<input type="checkbox"/>	<input type="checkbox"/>	<input type="checkbox"/>	6-135
Value	Input terminal																																																																			
-11	PSI11																																																																			
-10	PSI10																																																																			
-9	PSI9																																																																			
-8	PSI8																																																																			
-7	PSI7																																																																			
-6	PSI6																																																																			
-5	PSI5																																																																			
-4	PSI4																																																																			
-3	PSI3																																																																			
-2	PSI2																																																																			
-1	PSI1																																																																			
0	OFF fixed																																																																			
1	PSI1																																																																			
2	PSI2																																																																			
3	PSI3																																																																			
4	PSI4																																																																			
5	PSI5																																																																			
6	PSI6																																																																			
7	PSI7																																																																			
8	PSI8																																																																			
9	PSI9																																																																			
10	PSI10																																																																			
11	PSI11																																																																			
12	PLC1																																																																			
13	PLC2																																																																			
14	PLC3																																																																			
15	PLC4																																																																			
16	ON fixed																																																																			
1	EMS Emergency stop	-11.	16.	3.	<input type="checkbox"/>	<input type="checkbox"/>	<input type="checkbox"/>	<input type="checkbox"/>	6-135																																																											
2	R-RUN Reverse run	-11.	16.	4.	<input type="checkbox"/>	<input type="checkbox"/>	<input type="checkbox"/>	<input type="checkbox"/>	6-135																																																											
3	F-JOG Forward jogging	-11.	16.	5.	<input type="checkbox"/>	<input type="checkbox"/>	<input type="checkbox"/>	<input type="checkbox"/>	6-135																																																											
4	R-JOG Reverse jogging	-11.	16.	6.	<input type="checkbox"/>	<input type="checkbox"/>	<input type="checkbox"/>	<input type="checkbox"/>	6-135																																																											
5	HOLD Hold signal	-11.	16.	0.	<input type="checkbox"/>	<input type="checkbox"/>	<input type="checkbox"/>	<input type="checkbox"/>	6-135																																																											
6	BRAKE DC brake	-11.	16.	0.	<input type="checkbox"/>	<input type="checkbox"/>	<input type="checkbox"/>	<input type="checkbox"/>	6-135																																																											
7	RESET Breakdown reset	-11.	16.	2.	<input type="checkbox"/>	<input type="checkbox"/>	<input type="checkbox"/>	<input type="checkbox"/>	6-135																																																											
8	COP Serial transmission selection	-11.	16.	0.	<input type="checkbox"/>	<input type="checkbox"/>	<input type="checkbox"/>	<input type="checkbox"/>	6-135																																																											
9	CSEL Ramp selection	-11.	16.	0.	<input type="checkbox"/>	<input type="checkbox"/>	<input type="checkbox"/>	<input type="checkbox"/>	6-135																																																											
A	IPASS Ratio interlock bypass	-11.	16.	0.	<input type="checkbox"/>	<input type="checkbox"/>	<input type="checkbox"/>	<input type="checkbox"/>																																																												
B	CPASS Ramp bypass	-11.	16.	0.	<input type="checkbox"/>	<input type="checkbox"/>	<input type="checkbox"/>	<input type="checkbox"/>																																																												
C	PIDEN PID control selection	-11.	16.	0.	<input type="checkbox"/>	<input type="checkbox"/>	<input type="checkbox"/>	<input type="checkbox"/>																																																												
D	VFS Speed setting 1	-11.	16.	16.	<input type="checkbox"/>	<input type="checkbox"/>	<input type="checkbox"/>	<input type="checkbox"/>																																																												
E	IFS Speed setting 2	-11.	16.	0.	<input type="checkbox"/>	<input type="checkbox"/>	<input type="checkbox"/>	<input type="checkbox"/>																																																												
F	AUX Speed setting 3	-11.	16.	0.	<input type="checkbox"/>	<input type="checkbox"/>	<input type="checkbox"/>	<input type="checkbox"/>																																																												
C04 – Sequence input terminal function – 2																																																																				
0	PROG Program function enable	-11.	16.	0.	<input type="checkbox"/>	<input type="checkbox"/>	<input type="checkbox"/>	<input type="checkbox"/>	6-135																																																											
1	CFS Serial communication setting select	-11.	16.	0.	<input type="checkbox"/>	<input type="checkbox"/>	<input type="checkbox"/>	<input type="checkbox"/>	6-135																																																											
2	S0 Program speed selection	-11.	16.	0.	<input type="checkbox"/>	<input type="checkbox"/>	<input type="checkbox"/>	<input type="checkbox"/>	6-135																																																											
3	S1 Program speed selection	-11.	16.	0.	<input type="checkbox"/>	<input type="checkbox"/>	<input type="checkbox"/>	<input type="checkbox"/>	6-135																																																											
4	S2 Program speed selection	-11.	16.	0.	<input type="checkbox"/>	<input type="checkbox"/>	<input type="checkbox"/>	<input type="checkbox"/>	6-135																																																											
5	S3 Program speed selection	-11.	16.	0.	<input type="checkbox"/>	<input type="checkbox"/>	<input type="checkbox"/>	<input type="checkbox"/>	6-135																																																											
6	SE Program speed selection	-11.	16.	0.	<input type="checkbox"/>	<input type="checkbox"/>	<input type="checkbox"/>	<input type="checkbox"/>	6-135																																																											
7	FUP Frequency (speed) increase	-11.	16.	0.	<input type="checkbox"/>	<input type="checkbox"/>	<input type="checkbox"/>	<input type="checkbox"/>	6-135																																																											
8	FDW Frequency (speed) decrease	-11.	16.	0.	<input type="checkbox"/>	<input type="checkbox"/>	<input type="checkbox"/>	<input type="checkbox"/>	6-135																																																											
9	BUP Ratio interlock bias increase	-11.	16.	0.	<input type="checkbox"/>	<input type="checkbox"/>	<input type="checkbox"/>	<input type="checkbox"/>	6-135																																																											
A	BDW Ratio interlock bias decrease	-11.	16.	0.	<input type="checkbox"/>	<input type="checkbox"/>	<input type="checkbox"/>	<input type="checkbox"/>																																																												
B	IVLM Ratio interlock bias increase/decrease selection	-11.	16.	0.	<input type="checkbox"/>	<input type="checkbox"/>	<input type="checkbox"/>	<input type="checkbox"/>																																																												
C	AUXDV Auxiliary drive selection	-11.	16.	0.	<input type="checkbox"/>	<input type="checkbox"/>	<input type="checkbox"/>	<input type="checkbox"/>																																																												
D	PICK Pick-up	-11.	16.	0.	<input type="checkbox"/>	<input type="checkbox"/>	<input type="checkbox"/>	<input type="checkbox"/>																																																												
E	MBRK_ans External brake answer	-11.	16.	0.	<input type="checkbox"/>	<input type="checkbox"/>	<input type="checkbox"/>	<input type="checkbox"/>																																																												
F	PRST STP reset	-11.	16.	0.	<input type="checkbox"/>	<input type="checkbox"/>	<input type="checkbox"/>	<input type="checkbox"/>																																																												

6. Control Functions and Parameter Settings

Block-C parameters list

No.	Parameter	Min.	Max.	Default (Unit)	Function	Application				Ref. page																										
						Vf	VEC	PM	RWE																											
C05 – Sequence input terminal function – 3																																				
0	S5 Digital torque bias 1	-11.	16.	0.		<input type="checkbox"/>	<input type="checkbox"/>	<input type="checkbox"/>	<input type="checkbox"/>	6-135																										
1	S6 Digital torque bias 2	-11.	16.	0.		<input type="checkbox"/>	<input type="checkbox"/>	<input type="checkbox"/>	<input type="checkbox"/>	6-135																										
2	S7 Digital torque bias 3	-11.	16.	0.		<input type="checkbox"/>	<input type="checkbox"/>	<input type="checkbox"/>	<input type="checkbox"/>	6-135																										
3	AUXSW0 Auxiliary drive No selection L	-11.	16.	0.		<input type="checkbox"/>	<input type="checkbox"/>	<input type="checkbox"/>	<input type="checkbox"/>	6-135																										
4	AUXSW1 Auxiliary drive No selection H	-11.	16.	0.		<input type="checkbox"/>	<input type="checkbox"/>	<input type="checkbox"/>	<input type="checkbox"/>	6-135																										
5	PLS_IN Pulse train input selection	-11.	16.	0.		<input type="checkbox"/>	<input type="checkbox"/>	<input type="checkbox"/>	<input type="checkbox"/>	6-135																										
6	OCLLV1 OCL Level setting 1	-11.	16.	0.		<input type="checkbox"/>	<input type="checkbox"/>	<input type="checkbox"/>	<input type="checkbox"/>	6-135																										
7	OCLLV2 OCL Level setting 2	-11.	16.	0.		<input type="checkbox"/>	<input type="checkbox"/>	<input type="checkbox"/>	<input type="checkbox"/>	6-135																										
C06 – Sequence input terminal function – 4																																				
0	EXC Pre-excitation	-11.	16.	0.		<input type="checkbox"/>	<input type="checkbox"/>	<input type="checkbox"/>	<input type="checkbox"/>	6-135																										
1	ACR ACR	-11.	16.	0.		<input type="checkbox"/>	<input type="checkbox"/>	<input type="checkbox"/>	<input type="checkbox"/>	6-135																										
2	PCTL P control	-11.	16.	0.		<input type="checkbox"/>	<input type="checkbox"/>	<input type="checkbox"/>	<input type="checkbox"/>	6-135																										
3	LIM1 Drive torque limiter changeover	-11.	16.	0.		<input type="checkbox"/>	<input type="checkbox"/>	<input type="checkbox"/>	<input type="checkbox"/>	6-135																										
4	LIM2 Regenerative torque limiter changeover	-11.	16.	0.		<input type="checkbox"/>	<input type="checkbox"/>	<input type="checkbox"/>	<input type="checkbox"/>	6-135																										
5	MCH Machine time constant changeover	-11.	16.	0.		<input type="checkbox"/>	<input type="checkbox"/>	<input type="checkbox"/>	<input type="checkbox"/>	6-135																										
6	RF0 0 setting	-11.	16.	0.		<input type="checkbox"/>	<input type="checkbox"/>	<input type="checkbox"/>	<input type="checkbox"/>	6-135																										
7	DROOP Drooping changeover	-11.	16.	0.		<input type="checkbox"/>	<input type="checkbox"/>	<input type="checkbox"/>	<input type="checkbox"/>	6-135																										
8	DEDB Dead band setting	-11.	16.	0.		<input type="checkbox"/>	<input type="checkbox"/>	<input type="checkbox"/>	<input type="checkbox"/>	6-135																										
9	TRQB1 Torque bias setting 1	-11.	16.	0.		<input type="checkbox"/>	<input type="checkbox"/>	<input type="checkbox"/>	<input type="checkbox"/>	6-135																										
A	TRQB2 Torque bias setting 2	-11.	16.	0.		<input type="checkbox"/>	<input type="checkbox"/>	<input type="checkbox"/>	<input type="checkbox"/>	6-135																										
C07 – Analog input terminal function																																				
0	Speed setting 1	0.	11.	2.		<input type="checkbox"/>	<input type="checkbox"/>	<input type="checkbox"/>	<input type="checkbox"/>	6-135																										
1	Speed setting 2	0.	11.	3.		<input type="checkbox"/>	<input type="checkbox"/>	<input type="checkbox"/>	<input type="checkbox"/>	6-135																										
2	Speed setting 3	0.	11.	0.		<input type="checkbox"/>	<input type="checkbox"/>	<input type="checkbox"/>	<input type="checkbox"/>	6-135																										
3	Ratio interlock bias setting	0.	11.	0.		<input type="checkbox"/>	<input type="checkbox"/>	<input type="checkbox"/>	<input type="checkbox"/>	6-135																										
4	Traverse center frequency	0.	11.	0.		<input type="checkbox"/>	<input type="checkbox"/>	<input type="checkbox"/>	<input type="checkbox"/>	6-135																										
5	PID feedback	0.	11.	0.		<input type="checkbox"/>	<input type="checkbox"/>	<input type="checkbox"/>	<input type="checkbox"/>	6-135																										
6	Torque setting	0.	11.	0.		<input type="checkbox"/>	<input type="checkbox"/>	<input type="checkbox"/>	<input type="checkbox"/>	6-135																										
7	Drive torque limiter reduction setting	0.	11.	1.		<input type="checkbox"/>	<input type="checkbox"/>	<input type="checkbox"/>	<input type="checkbox"/>	6-135																										
8	Regenerative torque limiter reduction setting	0.	11.	1.		<input type="checkbox"/>	<input type="checkbox"/>	<input type="checkbox"/>	<input type="checkbox"/>	6-135																										
9	Torque bias 1 setting	0.	11.	0.		<input type="checkbox"/>	<input type="checkbox"/>	<input type="checkbox"/>	<input type="checkbox"/>	6-135																										
A	Analog torque bias setting	0.	11.	0.		<input type="checkbox"/>	<input type="checkbox"/>	<input type="checkbox"/>	<input type="checkbox"/>	6-135																										
<table border="1" style="display: inline-table; border-collapse: collapse;"> <thead> <tr> <th>Value</th> <th>Input terminal</th> </tr> </thead> <tbody> <tr><td>0</td><td>0% fixed</td></tr> <tr><td>1</td><td>100% fixed</td></tr> <tr><td>2</td><td>AI1</td></tr> <tr><td>3</td><td>AI2</td></tr> <tr><td>4</td><td>AI3</td></tr> <tr><td>5</td><td>PAI4 (OP)</td></tr> <tr><td>6</td><td>PAI5 (OP)</td></tr> <tr><td>7</td><td>PAI6 (OP)</td></tr> <tr><td>8</td><td>Built-in PLC output 1</td></tr> <tr><td>9</td><td>Built-in PLC output 2</td></tr> <tr><td>10</td><td>Built-in PLC output 3</td></tr> <tr><td>11</td><td>Built-in PLC output 4</td></tr> </tbody> </table> <p>PAI4 to PAI6 are for future.</p>						Value	Input terminal	0	0% fixed	1	100% fixed	2	AI1	3	AI2	4	AI3	5	PAI4 (OP)	6	PAI5 (OP)	7	PAI6 (OP)	8	Built-in PLC output 1	9	Built-in PLC output 2	10	Built-in PLC output 3	11	Built-in PLC output 4	<input type="checkbox"/>	<input type="checkbox"/>	<input type="checkbox"/>	<input type="checkbox"/>	6-135
Value	Input terminal																																			
0	0% fixed																																			
1	100% fixed																																			
2	AI1																																			
3	AI2																																			
4	AI3																																			
5	PAI4 (OP)																																			
6	PAI5 (OP)																																			
7	PAI6 (OP)																																			
8	Built-in PLC output 1																																			
9	Built-in PLC output 2																																			
10	Built-in PLC output 3																																			
11	Built-in PLC output 4																																			
C08 – Automatic start setting																																				
0	Auto start (To F-RUN/R-RUN)	1.	3.	1.	= 1: off = 2: on without pick-up = 3: on with pick-up (re-start after a momentary power loss)	<input type="checkbox"/>	<input type="checkbox"/>	<input type="checkbox"/>	<input type="checkbox"/>	6-136																										

6. Control Functions and Parameter Settings

Block-C parameters list

No.	Parameter	Min.	Max.	Default (Unit)	Function	Application				Ref. page																																																										
						V/f	VEC	PM	RWE																																																											
C09 – Parameter protection/operation locks																																																																				
0	Parameter protection	1.	9.	1.	<p>Set to prevent unintentional operation from the operation panel (OPU). Set whether to enable or prohibit data changing for each parameter function unit as shown above.</p> <p>Parameter protection: ○ : Unprotected (changeable) × : Protected (unchangeable)</p> <table border="1" style="margin-left: 20px;"> <thead> <tr> <th rowspan="2">Value</th> <th rowspan="2">Block A</th> <th colspan="4">Block B, C</th> </tr> <tr> <th>Basic</th> <th>Extn.</th> <th>S/W</th> <th>H/W</th> </tr> </thead> <tbody> <tr><td>1</td><td>○</td><td>○</td><td>○</td><td>○</td><td>○</td></tr> <tr><td>2</td><td>×</td><td>×</td><td>×</td><td>×</td><td>×</td></tr> <tr><td>3</td><td>○</td><td>×</td><td>×</td><td>×</td><td>×</td></tr> <tr><td>4</td><td>○</td><td>×</td><td>○</td><td>×</td><td>×</td></tr> <tr><td>5</td><td>○</td><td>×</td><td>○</td><td>○</td><td>×</td></tr> <tr><td>6</td><td>○</td><td>○</td><td>○</td><td>○</td><td>○</td></tr> <tr><td>7, 8</td><td>×</td><td>×</td><td>×</td><td>×</td><td>×</td></tr> <tr><td>9</td><td>○</td><td>○</td><td>○</td><td>○</td><td>○</td></tr> </tbody> </table>	Value	Block A	Block B, C				Basic	Extn.	S/W	H/W	1	○	○	○	○	○	2	×	×	×	×	×	3	○	×	×	×	×	4	○	×	○	×	×	5	○	×	○	○	×	6	○	○	○	○	○	7, 8	×	×	×	×	×	9	○	○	○	○	○	○	○	○	○	6-137
Value	Block A	Block B, C																																																																		
		Basic	Extn.	S/W	H/W																																																															
1	○	○	○	○	○																																																															
2	×	×	×	×	×																																																															
3	○	×	×	×	×																																																															
4	○	×	○	×	×																																																															
5	○	×	○	○	×																																																															
6	○	○	○	○	○																																																															
7, 8	×	×	×	×	×																																																															
9	○	○	○	○	○																																																															
1	Operation panel lock	1.	3.	1.	<p>= 1: Enable control from Operation Panel = 2: Disable control from Operation Panel (except for STOP key, if pressed for 2 seconds, will stop the drive) = 3: Only STOP key is available</p>	○	○	○	○	6-137																																																										
2	LCL switchover protection	1.	2.	1.	<p>= 1: Disables switchover while the drive is running = 2: Enables switchover while the drive is running</p>	○	○	○	○	6-137																																																										
3	Reveres run sequence (R:RUN) prohibit	1.	2.	1.	<p>Set this to prevent unintentional reverse run operation. When set to "2", the sequence input "R RUN" operation command will be disabled. Note that if the reverse run setting (negative value) is input into the speed setting during "F:RUN" operation, reverse run will start. = 1: Enable = 2: Prohibit</p>	○	○	○	○																																																											
4	Reverse run jogging sequence (R:JOG) prohibit	1.	2.	1.	<p>Set this to prevent unintentional reverse jogging operation. When set to "2", the "R:JOG" operation command will be disabled. Note that if the reverse run setting (negative value) is input into the jogging setting during "F:JOG" operation, reverse run will start. = 1: Enable = 2: Prohibit</p>	○	○	○	○																																																											
5	Reverse run during ACR mode prohibit	1.	2.	1.	<p>Set this to prevent unintentional reverse run operation. When set to "2", reverse run during ACR operation will be prohibited. The reverse run speed will be limited to approx. 1% if reverse run is started. This setting is ignored in the V/f mode. = 1: Enable = 2: Prohibit</p>		○	○																																																												
6	Fault history buffer clear	0	9999	0.	<p>Set 1 for the setting value to clear the fault history details. The clearing operation will not take place at a setting other than 1. 1: Clear fault history 2405: Reset software</p>	○	○	○	○	6-138																																																										

6. Control Functions and Parameter Settings

Block-C parameters list

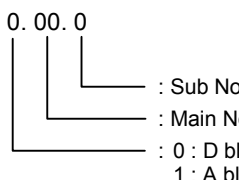
No.	Parameter	Min.	Max.	Default (Unit)	Function	Application				Ref. page
						V/F	VEC	PM	RWE	
7	Default value load	0	9999	0.	9: All default values load 10: Parameter A 11: Parameters B, C basic functions 12: Parameters B, C extended functions 13: Parameter B software option function Parameter C hardware option function 14: Parameters B basic functions 15: Parameters B extended functions 16: Parameter B software option function 17: Parameters C basic functions 18: Parameters C extended functions 19: Parameter C hardware option function	○	○	○		6-138
C10 – Custom parameter register										
0	Custom – 0	1.00.0	2.FF.F	1.9F.F	Set for each parameter No. to be displayed and changed as an A04-0 to 7 custom parameter. Example) To set B13-0 (torque setting), set as 1.13.0.	○	○	○	○	6-138
1	Custom – 1	1.00.0	2.FF.F	1.9F.F		○	○	○	○	6-138
2	Custom – 2	1.00.0	2.FF.F	1.9F.F		○	○	○	○	6-138
3	Custom – 3	1.00.0	2.FF.F	1.9F.F		○	○	○	○	6-138
4	Custom – 4	1.00.0	2.FF.F	1.9F.F		○	○	○	○	6-138
5	Custom – 5	1.00.0	2.FF.F	1.9F.F		○	○	○	○	6-138
6	Custom – 6	1.00.0	2.FF.F	1.9F.F		○	○	○	○	6-138
7	Custom – 7	1.00.0	2.FF.F	1.9F.F		○	○	○	○	6-138
C11 – Operation panel mode setting										
0	Initial mode	1.	2.	1.	The initial operation mode for when the power is turned ON is set = 1: Local = 2: Remote	○	○	○	○	
1	Run command status	1.	3.	1.	The initial operation mode for when the power is turned ON, if using the automatic start function (when C08-0 =2 or 3) during the local operation mode (operation from operation panel) is set. If =2 is set, forward run will start when the run enable state is entered after the power is turned ON. = 1: Stop = 2: Forward run = 3: Reverse run	○	○	○	○	
2	Operation panel frequency change operation	1.	2.	1.	Used to prevent changes to the frequency/rotation speed settings in real time. =1: Change in real time =2: Change using the Set key.	○	○	○	○	
3	Operation panel monitor parameter	0.00.0	1.9F.F	0.00.0	Select the parameters displayed first when the power is turned ON. 0. 00. 0  : Sub No. : Main No. : 0 : D block 1 : A block	○	○	○	○	
4	LCD panel: Language setting	0.	4.	0.	Select the language displayed on the LCD panel. =0: English =1: French =2: German =3: Spanish =4: Italian (This is displayed only when the LCD panel is connected)	○	○	○	○	
5	LCD panel: Contrast adjustment	-10.	5.	0.	Adjust the contrast of the characters displayed on the LCD panel. (This is displayed only when the LCD panel is connected)	○	○	○	○	

6. Control Functions and Parameter Settings

Block-C parameters list

No.	Parameter	Min.	Max.	Default (Unit)	Function	Application				Ref. page
						Vf	VEC	PM	RWE	
6	LCD panel: Backlight OFF timer setting	0.	255.	0. (s)	Set the time to turn ON the LCD panel's backlight. =0: Always ON =Other than 0: Turns OFF when there is no operation for set time (This is displayed only when the LCD panel is connected)	○	○	○	○	
7	Panel operation method selection	1.	2.	1.	=1: Conventional method =2: Main No. selection method	○	○	○	○	
C12 – Setting input terminal function										
0	AI1 Terminal input mode selection	1.	2.	1.	= 1: Voltage input, = 2: Current input	○	○	○		6-139
1	AI1 Voltage input mode selection	1.	3.	1.	= 1: 0 to 10V, = 2: 0 to 5V, = 3: 1 to 5V	○	○	○		6-139
2	AI1 Current input mode selection	1.	2.	1.	= 1: 4 to 20mA, = 2: 0 to 20mA	○	○	○		6-139
3	Filter time constant for AI1 input	2.	250.	8. (ms)	A time constant of setting value/2ms is applied on the input value.	○	○	○		6-141
4	AI2 terminal input mode	1.	2.	1.	= 1: Voltage input, = 2: Current input	○	○	○		6-139
5	AI2 voltage input mode	1.	3.	1.	= 1: 0 to 10V, = 2: 0 to 5V, = 3: 1 to 5V	○	○	○		6-139
6	AI2 current input mode	1.	2.	1.	= 1: 4 to 20mA, = 2: 0 to 20mA	○	○	○		6-139
7	Filter time constant for AI2 input	2.	250.	8. (ms)	A time constant of setting value/2ms is applied on the input value.	○	○	○		6-141
8	AI3 terminal input mode	1.	3.	1.	= 1: 0 to ±10V, = 2: 0 to ±5V, = 3: 1 to 5V	○	○	○		6-140
9	AI3 input gain	0.000	5.000	1.000	A magnification gain is applied on the AI3 input value.	○	○	○	○	6-140
A	Filter time constant for AI3 input	2.	250.	8. (ms)	A time constant of setting value/2ms is applied on the input value.	○	○	○		6-141
B	Program setting filter	0.00	1.00	0.01 (s)	The program setting inputs are filtered with the setting terminal batch. (Prevents incorrect setting caused by chattering.)	○	○	○	○	6-141
C	Pulse train input F1 setting frequency	0.1	1000.0	10.0 (Hz)	There is the following restriction. C12-C x 2 ≤ C12-D Refer to section 5-7-3 for details on the parameters related to the pulse train input function.	○	○	○	○	6-141
D	Pulse train input F2 setting frequency	1.	10000.	1000. (Hz)		○	○	○	○	6-141
E	Pulse train input frequency LPF time constant	0.	2000.	1. (ms)		○	○	○	○	6-141
F	Pulse train input judgment time	0.01	20.00	1.00 (s)		○	○	○	○	6-141
C13 – Output terminal function										
0	A01 terminal output	0.	21.	0.	Select the setting value from the following table, and output.	○	○	○	○	6-141
1	A02 terminal output	0.	21.	3.		○	○	○	○	6-141
	Value	Parameter	Terminal voltage		Value	Parameter	Terminal voltage			
	0	Output frequency	10V at Max. frequency		11	Torque current	5V at Motor rated current			
	1	Setting frequency Setting speed	10V at Max. frequency 10V at Max. speed		12	Excitation current	5V at Motor rated current			
	2	Ramp output	10V at Max. frequency 10V at Max. speed		13	Actual motor rotation speed	10V at Max. speed			
	3	Output current (Motor)	5V at Motor rated current		14	Namp output	10V at Rated torque			
	4	Output current (Drive)	5V at drive rated current		15	Overload monitor (motor protection)	10V at 100%			
	5	Output voltage	10V at Motor rated voltage		16	Built-in PLC output 1	10V/1000h			
	6	Motor output power	5V at (Rated output voltage × Motor rated current)		17	Built-in PLC output 2	10V/1000h			
	7	DC voltage	5V at 300V (200V Series) 5V at 600V (400V Series)		18	Built-in PLC output 3	10V/1000h			
	8	Overload monitor (unit protection)	10V at 100%		19	Built-in PLC output 4	10V/1000h			
	9	Heat sink temperature	10V at 100°C		20	DM1 for maker maintenance	10V/1000h			
	10	Motor speed	10V at Max. speed		21	DM2 for maker maintenance	10V/1000h			

6. Control Functions and Parameter Settings

Block-C parameters list

No.	Parameter	Min.	Max.	Default (Unit)	Function	Application				Ref. page
						V/f	VEC	PM	RWE	
C14 – Meter output gain										
0	Output gain for A01	0.20	2.00	1.00	10V at Max. frequency when this is set to 1.00.	○	○	○	○	6-142
1	Output gain for A02	0.20	2.00	1.00	20mA (5V) at the rated current when this is set to 1.00. (Max. 11V)	○	○	○	○	6-142
2	Random scale (AS) display coefficient	0.01	100.00	30.00	Set the coefficient for the D00-4 and D01-5 random scale display.	○	○	○	○	6-144
3	A01 output offset (Voltage)	-8.00	8.00	0.00 (V)	When C14-7 or 8 is set to 1 or 3, the offset can be fluctuated with this setting value. If the offset is set to a value other than 0V, the output which can be displayed with ±, such as the output frequency, can be ± output in the range of 0 to 10V centering on this setting value. The absolute value is output when 0.00 is set.	○	○	○	○	6-142
4	A02 output offset (Voltage)	-8.00	8.00	0.00 (V)		○	○	○	○	6-142
5	A01 output offset (Current)	-15.0	15.0	0.0 (mA)	When C14-7 or 8 is set to 2, the offset can be fluctuated with this setting value.	○	○	○	○	6-142
6	A02 output offset (Current)	-15.0	15.0	0.0 (mA)		○	○	○	○	6-142
7	A01 output method selection	1.	3.	1.	=1: Voltage 0V to 10V = 3: Current 4mA to 20mA	○	○	○		6-142
8	A02 output method selection	1.	3.	1.	=2: Voltage 0V to 10V (5V offset) When =2 is set, the gain will be set to a 0.5-fold setting using the 5V point as the reference point.	○	○	○		6-142
9	AI1 random scale coefficient	0.01	100.00	30.00	Analog input: Random scale coefficient dedicated for AI1	○	○	○	○	6-144
A	AI2 random scale coefficient	0.01	100.00	30.00	Analog input: Random scale coefficient dedicated for AI2	○	○	○	○	6-144
B	AI3 random scale coefficient	0.01	100.00	30.00	Analog input: Random scale coefficient dedicated for AI3	○	○	○	○	6-144

6. Control Functions and Parameter Settings

Block-C parameters list

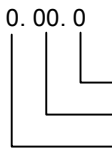
No.	Parameter	Min.	Max.	Default (Unit)	Function	Application				Ref. page	
						Vf	VEC	PM	RWE		
C15 – Status output detection level											
0	Attainment (ATN) detection width	0.0	20.0	1.0 (%)	The attained output (ATN) operation width is set.	<input type="checkbox"/>	<input type="checkbox"/>	<input type="checkbox"/>	<input type="checkbox"/>	6-145	
1	Current (IDET) detection level	5.	300.	100. (%)	The current detection (IDET) operation level is set.	<input type="checkbox"/>	<input type="checkbox"/>	<input type="checkbox"/>	<input type="checkbox"/>	6-145	
2	Speed detection (SPD1) level – 1	1.0	105.0	95.0 (%)	The speed detection (SPD1, SPD2) operation level is set.	<input type="checkbox"/>	<input type="checkbox"/>	<input type="checkbox"/>	<input type="checkbox"/>	6-145	
3	Speed detection (SPD2) level – 2	1.0	105.0	50.0 (%)		<input type="checkbox"/>	<input type="checkbox"/>	<input type="checkbox"/>	<input type="checkbox"/>	6-145	
4	Zero speed detection (ZSP) level	0.00	50.00	1.00 (s)	The zero speed detection (ZSP) operation level is set.	<input type="checkbox"/>	<input type="checkbox"/>	<input type="checkbox"/>	<input type="checkbox"/>	6-145	
5	RDELAY delay time	0.0	1000.0	1.0 (s)	Set the delay time for RDELAY output.	<input type="checkbox"/>	<input type="checkbox"/>	<input type="checkbox"/>	<input type="checkbox"/>	6-146	
6	EC0 output fault selection	0.00.0	1.FF.F.	0.00.0.	When only a specific fault is to be output, this parameter can be set so that only the fault with the set conditions is output with sequence output:EC0 to EC3. 0. 00. 0  : Sub No. : Fault No. : 0 : Normal fault 1 : Monitor fault	<input type="checkbox"/>	<input type="checkbox"/>	<input type="checkbox"/>	<input type="checkbox"/>	6-146	
7	EC1 output fault selection	0.00.0	1.FF.F.	0.00.0.		<input type="checkbox"/>	<input type="checkbox"/>	<input type="checkbox"/>	<input type="checkbox"/>	6-146	
8	EC2 output fault selection	0.00.0	1.FF.F.	0.00.0.		<input type="checkbox"/>	<input type="checkbox"/>	<input type="checkbox"/>	<input type="checkbox"/>	6-146	
9	EC3 output fault selection	0.00.0	1.FF.F.	0.00.0.		<input type="checkbox"/>	<input type="checkbox"/>	<input type="checkbox"/>	<input type="checkbox"/>	6-146	
Normal fault No. table											
No.	Corresponding fault	No.	Corresponding fault	No.	Corresponding fault	No.	Corresponding fault	No.	Corresponding fault	No.	Corresponding fault
00	None	04	OV	08	SP	0C	GRD	10	BPFLT		
01	EMS	05	UV	09	CONV	0D	IO	11	For future use		
02	PM	06	PHL	0A	ATT	0E	CPU	12	For future use		
03	OC	07	UOH	0B	OL	0F	FUSE	13	For future use		
Minor fault No. table											
No.	Corresponding fault	No.	Corresponding fault	No.	Corresponding fault	No.	Corresponding fault	No.	Corresponding fault	No.	Corresponding fault
00	None	04	Speed deviation error	05	Pump control upper limit	06	Pump control lower limit	07	AI1 current input 3mA or less	08	AI2 current input 3mA or less
01	Speed (position) detection error										
02	Carrier f decelerating										
03	Overload error (50% or more)										
A	EC0 OFF delay timer	0.0	600.0	0.1 (s)	When a minor fault occurs, delay is applied for the set time if the minor fault occurrence conditions are reset. Note that if 0.00 is set, the operation will not turn OFF and instead will remain ON. In either case, this will turn OFF regardless of the setting when RST is turned ON.	<input type="checkbox"/>	<input type="checkbox"/>	<input type="checkbox"/>	<input type="checkbox"/>	6-146	
B	EC1 OFF delay timer	0.0	600.0	0.1 (s)		<input type="checkbox"/>	<input type="checkbox"/>	<input type="checkbox"/>	<input type="checkbox"/>	6-146	
C	EC2 OFF delay timer	0.0	600.0	0.1 (s)		<input type="checkbox"/>	<input type="checkbox"/>	<input type="checkbox"/>	<input type="checkbox"/>	6-146	
D	EC3 OFF delay timer	0.0	600.0	0.1 (s)		<input type="checkbox"/>	<input type="checkbox"/>	<input type="checkbox"/>	<input type="checkbox"/>	6-146	
E	ALM OFF delay timer	0.0	600.0	0.1 (s)		<input type="checkbox"/>	<input type="checkbox"/>	<input type="checkbox"/>	<input type="checkbox"/>	6-146	

6. Control Functions and Parameter Settings

Block-C parameters list

No.	Parameter	Min.	Max.	Default (Unit)	Function	Application				Ref. page
						V/f	VEC	PM	RWE	
C20 – Start interlock										
0	Start/stop frequency (speed)	0.0	20.0	0.0 (%)	The motor will stop when below this frequency setting.	<input type="radio"/>	<input type="radio"/>	<input type="radio"/>	<input type="radio"/>	6-147
1	Start/stop frequency (speed) hysteresis	0.0	20.0	1.0 (%)	If the motor stops when the set frequency is set to C20-0 or less, the set frequency must be raised to a level which exceeds C20-0 plus this setting value in order to resume operation.	<input type="radio"/>	<input type="radio"/>	<input type="radio"/>	<input type="radio"/>	6-147
2	Interlock frequency (speed)	0.0	20.0	0.0 (%)	The motor will not start when the setting is above this frequency. (When using with the setting start, set a value that is larger than the setting start frequency.) When C20-0=0, the setting start/stop will not operate. When C20-2=0, the setting interlock will not operate.	<input type="radio"/>	<input type="radio"/>	<input type="radio"/>	<input type="radio"/>	6-147
3	RUN delay timer	0.00	10.00	0.00 (s)	Operation is started when the time corresponding to the setting value has elapsed from the run command.	<input type="radio"/>	<input type="radio"/>	<input type="radio"/>	<input type="radio"/>	6-147
C21 – Retry/pick-up										
0	Number of retries	0.	10.	0.	Set the number of times to retry. Retry is not executed when set to 0.	<input type="radio"/>	<input type="radio"/>	<input type="radio"/>	<input type="radio"/>	6-148
1	Retry wait time	1.	30.	5. (s)	Set the time from fault occurrence to the start of retry.	<input type="radio"/>	<input type="radio"/>	<input type="radio"/>	<input type="radio"/>	6-148
2	Pick-up wait time	0.5	10.0	2.0 (s)	Set the time to wait before starting pick-up operation after the output has been cut off.	<input type="radio"/>	<input type="radio"/>	<input type="radio"/>	<input type="radio"/>	6-148
3	Pick-up current limit value	50.	300.	100. (%)	Set within the following range only if the output torque is to be limited when restarting. C21-3 setting value \geq applicable motor exciting current +10%	<input type="radio"/>	<input type="radio"/>	<input type="radio"/>	<input type="radio"/>	6-148
4	V/f pick-up function selection	1.	3.	1.	Select the pick-up operation for the reverse run direction. =1: No reverse run pick-up =2: Reverse run pick-up enabled (FMAX) =3: Reverse run pick-up enabled (estimated speed)	<input type="radio"/>	<input type="radio"/>	<input type="radio"/>	<input type="radio"/>	6-150
5	Sensor-less pick-up function selection	1.	3.	1.	Select the pick-up function for sensor-less vector control. =1: Reverse run pick-up disabled, start search from NMAX =2: Reverse run pick-up disabled, start search from setting value =3: Reverse run pick-up enabled, start search from NMAX	<input type="radio"/>	<input type="radio"/>	<input type="radio"/>	<input type="radio"/>	6-150
6	Speed estimation proportional gain for sensor-less pick-up	0.00	100.00	10.00 (%)	Set the speed estimation proportional gain used for pick-up during sensor-less vector control.	<input type="radio"/>	<input type="radio"/>	<input type="radio"/>	<input type="radio"/>	6-150
7	Speed estimation integral gain for sensor-less pick-up	0.00	300.00	1.00 (%)	Set the speed estimation integral gain used for pick-up during sensor-less vector control.	<input type="radio"/>	<input type="radio"/>	<input type="radio"/>	<input type="radio"/>	6-150

6. Control Functions and Parameter Settings

Block-C parameters list

No.	Parameter	Min.	Max.	Default (Unit)	Function	Application				Ref. page
						V/f	VEC	PM	RWE	
C22 – Overload										
0	Motor overload reference	50.0	105.0	100.0 (%)	Note that when this parameter is changed, Parameters C22-1 and C22-2 will automatically be adjusted to the value of this setting. Take care when decreasing and then increasing this value.	<input type="checkbox"/>	<input type="checkbox"/>	<input type="checkbox"/>		6-151
1	0Hz overload	20.0	105.0	100.0 (%)	The maximum value is as set on C22-2.	<input type="checkbox"/>	<input type="checkbox"/>	<input type="checkbox"/>		6-151
2	0.7Base freq. overload	50.0	105.0	100.0 (%)	The minimum value is as set on C22-1.	<input type="checkbox"/>	<input type="checkbox"/>	<input type="checkbox"/>		6-151
3	Motor overload breakdown reference	110.0	300.0	150.0 (%)	Set the trip overload breakdown reference at 1 minute. A breakdown stoppage (OL-3) will occur after 1 minute with the motor rated reference current value at this value. The default value is 120.0 when heavy-duty is set.	<input type="checkbox"/>	<input type="checkbox"/>	<input type="checkbox"/>		6-151
4	DBR overload	0.0	10.0	1.6 (%)	This parameter is for setting %ED of DBR operation. When DBR transistor or DBR built in the unit is used, set the parameter within the specification. When 0.0 is set, the protection function is disabled. When the external DBR unit is used, set to 0.0.	<input type="checkbox"/>	<input type="checkbox"/>	<input type="checkbox"/>		6-151
5	Motor power loss braking setting	0.	70.	50.0 (%)	This function is valid when control mode selection is C30-0:f0=1 or auxiliary drive is selected and main circuit option selection is C31-0:f0=2	<input type="checkbox"/>	<input type="checkbox"/>	<input type="checkbox"/>		6-152
6	Carrier frequency automatic reduction function selection	1.	2.	1.	=1: Reduction enabled =2: Reduction disabled	<input type="checkbox"/>	<input type="checkbox"/>	<input type="checkbox"/>	<input type="checkbox"/>	6-152
7	Phase failure detection function selection	11.	22.	11.	f0: Input phase failure detection function selection =1: Function valid =2: Function invalid f1: Output phase failure detection function selection =1: Function valid =2: Function invalid	<input type="checkbox"/>	<input type="checkbox"/>	<input type="checkbox"/>	<input type="checkbox"/>	6-152
C24 – Speed detection error monitor										
0	Over speed protection level	20.0	200.0	105.0 (%)	The over speed protection operation level is set.		<input type="checkbox"/>	<input type="checkbox"/>		6-153
1	Control mode changeover during speed detection error	1.	3.	1.	Select control at speed detection error =1: Speed detection error not monitored =2: Speed detection error monitored (Do not change to sensorless vector control) =3: Speed detection error monitored (Switch to sensorless vector control) Set whether to monitor speed detection errors, such as wire breakage of the speed detector circuit, and to change over from vector control to sensorless vector control. There will be no switch to sensorless control for other than vector control. In this case, select 1 or 2.	<input type="checkbox"/>	<input type="checkbox"/>	<input type="checkbox"/>		6-153
2	Speed detection error level	1.0	100.0	10.0 (%)	The conditions for judging the speed detection error are set. Set as C24-2 ≥ C24-3.	<input type="checkbox"/>	<input type="checkbox"/>	<input type="checkbox"/>	<input type="checkbox"/>	6-153
3	Speed detection error recovery level	1.0	100.	5.0 (%)	When the speed detection value deviation is less than this setting value, it is determined that the speed detection has been reset properly.	<input type="checkbox"/>	<input type="checkbox"/>		<input type="checkbox"/>	6-153
4	Control mode changeover during speed deviation error	1.	3.	1.	Select speed deviation control error. =1: No error monitoring performed, no ALM output, no FLT output =2: Error monitoring performed, no ALM output, FLT output performed =3: Error monitoring performed, ALM output performed, no FLT output		<input type="checkbox"/>	<input type="checkbox"/>		6-154

6. Control Functions and Parameter Settings

Block-C parameters list

No.	Parameter	Min.	Max.	Default (Unit)	Function	Application				Ref. page																																								
						V/f	VEC	PM	RWE																																									
C24 – Speed detection error monitor																																																		
5	Speed deviation error level	1.0	50.0	10.0 (%)	Set the error judgment command and the deviation level for detection.		<input type="radio"/>	<input type="radio"/>	<input type="radio"/>	6-154																																								
6	Speed deviation error judgment time	0.1	20.0	10.0 (s)	Set the time for judging speed deviation.		<input type="radio"/>	<input type="radio"/>	<input type="radio"/>	6-154																																								
7	Reverse error detection level	0.	100.	0. (%)	Set the error detection level for when the motor rotates in the reverse direction of the speed command. Set using the base speed as 100%. The error is not detected when 0 is set.		<input type="radio"/>	<input type="radio"/>	<input type="radio"/>	6-154																																								
C25 – High-efficiency operation																																																		
0	Voltage reduction time	0.1	30.0	10.0 (s)	Set the time for the output voltage to drop from the V/f setting value to 0V.	<input type="radio"/>	<input type="radio"/>	<input type="radio"/>		6-154																																								
1	Voltage lower limit setting value	50.	100.	100. (%)	When selecting a high-efficiency operation function, set 50 to 99.	<input type="radio"/>	<input type="radio"/>	<input type="radio"/>		6-154																																								
2	Cooling fan ON/OFF control	1.	2.	2.	=1: ON / OFF control is enabled. FAN is ON when inverter runs. The fan runs for 10s when starting. =2: ON / OFF control is disabled. FAN is always ON.	<input type="radio"/>	<input type="radio"/>	<input type="radio"/>		6-155																																								
C26 – Standard serial transmission setting																																																		
0	Function selection	1.	2.	1.	1: Standard serial 2: MODBUS	<input type="radio"/>	<input type="radio"/>	<input type="radio"/>		6-155																																								
1	Parameter change protection	1.	5.	1.	The parameters with a ○ mark below can be changed. <table border="1" style="margin: 5px auto; border-collapse: collapse;"> <thead> <tr> <th rowspan="2">Setting value</th> <th rowspan="2">Block A Parameter</th> <th colspan="4">Block B, C Parameter</th> </tr> <tr> <th>Basic</th> <th>Extend</th> <th>S/W</th> <th>H/W</th> </tr> </thead> <tbody> <tr> <td>1</td> <td>○</td> <td>○</td> <td>○</td> <td>○</td> <td>○</td> </tr> <tr> <td>2</td> <td>×</td> <td>×</td> <td>×</td> <td>×</td> <td>×</td> </tr> <tr> <td>3</td> <td>○</td> <td>×</td> <td>×</td> <td>×</td> <td>×</td> </tr> <tr> <td>4</td> <td>○</td> <td>×</td> <td>○</td> <td>×</td> <td>×</td> </tr> <tr> <td>5</td> <td>○</td> <td>×</td> <td>○</td> <td>○</td> <td>×</td> </tr> </tbody> </table> ○: Changeable ×: Unchangeable	Setting value	Block A Parameter	Block B, C Parameter				Basic	Extend	S/W	H/W	1	○	○	○	○	○	2	×	×	×	×	×	3	○	×	×	×	×	4	○	×	○	×	×	5	○	×	○	○	×	<input type="radio"/>	<input type="radio"/>	<input type="radio"/>		6-155
Setting value	Block A Parameter	Block B, C Parameter																																																
		Basic	Extend	S/W	H/W																																													
1	○	○	○	○	○																																													
2	×	×	×	×	×																																													
3	○	×	×	×	×																																													
4	○	×	○	×	×																																													
5	○	×	○	○	×																																													
2	Station No.	0.	247.	1.	Set the local station No.	<input type="radio"/>	<input type="radio"/>	<input type="radio"/>		6-155																																								
3	Response timer	0.00	2.00	0.00 (s)	Set the minimum time from receiving command to returning an answer.	<input type="radio"/>	<input type="radio"/>	<input type="radio"/>	<input type="radio"/>	6-155																																								
4	CN2 standard serial communication baud rate setting	1.	5.	2.	=1: 4800 =2: 9600 =3: 14400 =4: 19200 =5: 38400	<input type="radio"/>	<input type="radio"/>	<input type="radio"/>	<input type="radio"/>	6-155																																								
5	CN2 standard serial communication stop bit setting	1.	2.	2.	=1: 1 bit =2: 2 bit	<input type="radio"/>	<input type="radio"/>	<input type="radio"/>	<input type="radio"/>	6-156																																								
6	CN2 standard serial communication parity setting	1.	3.	3.	=1: None =2: Even =3: Odd	<input type="radio"/>	<input type="radio"/>	<input type="radio"/>	<input type="radio"/>	6-156																																								
7	Base section serial communication frequency (speed) unit setting	0.	0.	5.	=0: 0.01Hz or 0.1min ⁻¹ unit: signed =1: 0.1Hz or 1min ⁻¹ unit: signed =2: 0.01% unit: signed =3: 0.01Hz or 0.1min ⁻¹ unit: unsigned =4: 0.1Hz or 1min ⁻¹ unit: unsigned =5: 0.01% unit: unsigned	<input type="radio"/>	<input type="radio"/>	<input type="radio"/>	<input type="radio"/>	6-156																																								
C28 – Password No.																																																		
0	Password No. function valid	1.	2.	1.	=1: Function invalid =2: Function valid	<input type="radio"/>	<input type="radio"/>	<input type="radio"/>	<input type="radio"/>	6-156																																								
1	Password No. setting	0.	9999.	0.	Set the password No. Once set the display will return to 0, so make sure not to forget the set number.	<input type="radio"/>	<input type="radio"/>	<input type="radio"/>	<input type="radio"/>	6-156																																								

6. Control Functions and Parameter Settings

Block-C parameters list

No.	Parameter	Min.	Max.	Default (Unit)	Function	Application				Ref. page																																																																																																																								
						V/f	VEC	PM	RWE																																																																																																																									
C30 – Control mode selection																																																																																																																																		
0	Control mode selection	11.	24.	11.	f1: The overload mode is set. =1: Normal-duty (120%1min) =2: Heavy-duty (150%1min) f0: The control mode is set. =1: V/f control =2: IM speed sensor-less vector control =3: IM speed vector control with sensor =4: PM motor control with sensor	<input type="radio"/>	<input type="radio"/>	<input type="radio"/>	<input type="radio"/>	6-157																																																																																																																								
C31 – Main circuit option selection																																																																																																																																		
0	Main circuit option selection	1111.	1222.	1221.	f0: Motor loss braking (1=OFF, 2=ON) f1: DB selection (1=OFF, 2=ON) f2: OVL selection (1=OFF, 2=ON) f3: (For future use)	<input type="radio"/>	<input type="radio"/>	<input type="radio"/>	<input type="radio"/>	6-157																																																																																																																								
1	Ground fault detection function	1.	2.	1.	=1: Enabled =2: Disabled	<input type="radio"/>	<input type="radio"/>	<input type="radio"/>	<input type="radio"/>	6-157																																																																																																																								
2	UVL proportional gain	0.0	10.0	0.0 (%)	Set the gain for lowering the frequency at the start of UVL operation. The UVL function will be turned OFF if 0 is set. Set a value approx. half of the motor's rated slip.	<input type="radio"/>	<input type="radio"/>	<input type="radio"/>	<input type="radio"/>	6-157																																																																																																																								
3	UVL integral time constant	2.	200.	10. (ms)	Set the integral time constant for UVL operation. Reduce the value if UVT occurs.	<input type="radio"/>	<input type="radio"/>	<input type="radio"/>	<input type="radio"/>	6-157																																																																																																																								
C33 – Output terminal function (Option)																																																																																																																																		
0	PSO4 output parameters	-55.	55.	10.	Select the setting value from the following table, and output. -1 to -55 are the reverse output of 1 to 55.	<input type="radio"/>	<input type="radio"/>	<input type="radio"/>	<input type="radio"/>	6-157																																																																																																																								
1	PSO5 output parameters	-55.	55.	11.		<input type="radio"/>	<input type="radio"/>	<input type="radio"/>	<input type="radio"/>	6-157																																																																																																																								
2	PSO6 output parameters	-55.	55.	12.		<input type="radio"/>	<input type="radio"/>	<input type="radio"/>	<input type="radio"/>	6-157																																																																																																																								
3	PSO7 output parameters	-55.	55.	13.		<input type="radio"/>	<input type="radio"/>	<input type="radio"/>	<input type="radio"/>	6-157																																																																																																																								
<table border="1" style="width: 100%; border-collapse: collapse; text-align: center;"> <thead> <tr> <th>Value</th><th>Output signal</th><th>Value</th><th>Output signal</th><th>Value</th><th>Output signal</th><th>Value</th><th>Output signal</th><th>Value</th><th>Output signal</th><th>Value</th><th>Output signal</th></tr> </thead> <tbody> <tr><td>0</td><td>Fixed to OFF</td><td>8</td><td>IDET</td><td>16</td><td>EC3</td><td>24</td><td>LLMT</td><td>32</td><td>PLC1</td><td>40</td><td>FPOS</td></tr> <tr><td>1</td><td>RUN</td><td>9</td><td>ATN</td><td>17</td><td>ACC</td><td>25</td><td>ULMT</td><td>33</td><td>PLC2</td><td>41</td><td>For future use</td></tr> <tr><td>2</td><td>FLT</td><td>10</td><td>SPD1</td><td>18</td><td>DCC</td><td>26</td><td>Doff-End</td><td>34</td><td>PLC3</td><td>42</td><td>For future use</td></tr> <tr><td>3</td><td>MC</td><td>11</td><td>SPD2</td><td>19</td><td>AUXDV</td><td>27</td><td>MBRK</td><td>35</td><td>PLC4</td><td>43</td><td>For future use</td></tr> <tr><td>4</td><td>RDY1</td><td>12</td><td>COP</td><td>20</td><td>ALM</td><td>28</td><td>DVER</td><td>36</td><td>PLC5</td><td>44</td><td>For future use</td></tr> <tr><td>5</td><td>RDY2</td><td>13</td><td>EC0</td><td>21</td><td>FAN</td><td>29</td><td>BPF</td><td>37</td><td>PLC6</td><td>45</td><td>For future use</td></tr> <tr><td>6</td><td>LCL</td><td>14</td><td>EC1</td><td>22</td><td>ASW</td><td>30</td><td>RDELAY</td><td>38</td><td>PLC7</td><td>46</td><td>For future use</td></tr> <tr><td>7</td><td>REV</td><td>15</td><td>EC2</td><td>23</td><td>ZSP</td><td>31</td><td>Fixed to ON</td><td>39</td><td>PLC8</td><td>47</td><td>For future use</td></tr> <tr><td></td><td></td><td></td><td></td><td></td><td></td><td></td><td></td><td></td><td></td><td>55</td><td>MP08</td></tr> </tbody> </table>											Value	Output signal	Value	Output signal	Value	Output signal	Value	Output signal	Value	Output signal	Value	Output signal	0	Fixed to OFF	8	IDET	16	EC3	24	LLMT	32	PLC1	40	FPOS	1	RUN	9	ATN	17	ACC	25	ULMT	33	PLC2	41	For future use	2	FLT	10	SPD1	18	DCC	26	Doff-End	34	PLC3	42	For future use	3	MC	11	SPD2	19	AUXDV	27	MBRK	35	PLC4	43	For future use	4	RDY1	12	COP	20	ALM	28	DVER	36	PLC5	44	For future use	5	RDY2	13	EC0	21	FAN	29	BPF	37	PLC6	45	For future use	6	LCL	14	EC1	22	ASW	30	RDELAY	38	PLC7	46	For future use	7	REV	15	EC2	23	ZSP	31	Fixed to ON	39	PLC8	47	For future use											55	MP08
Value	Output signal	Value	Output signal	Value	Output signal	Value	Output signal	Value	Output signal	Value	Output signal																																																																																																																							
0	Fixed to OFF	8	IDET	16	EC3	24	LLMT	32	PLC1	40	FPOS																																																																																																																							
1	RUN	9	ATN	17	ACC	25	ULMT	33	PLC2	41	For future use																																																																																																																							
2	FLT	10	SPD1	18	DCC	26	Doff-End	34	PLC3	42	For future use																																																																																																																							
3	MC	11	SPD2	19	AUXDV	27	MBRK	35	PLC4	43	For future use																																																																																																																							
4	RDY1	12	COP	20	ALM	28	DVER	36	PLC5	44	For future use																																																																																																																							
5	RDY2	13	EC0	21	FAN	29	BPF	37	PLC6	45	For future use																																																																																																																							
6	LCL	14	EC1	22	ASW	30	RDELAY	38	PLC7	46	For future use																																																																																																																							
7	REV	15	EC2	23	ZSP	31	Fixed to ON	39	PLC8	47	For future use																																																																																																																							
										55	MP08																																																																																																																							

6. Control Functions and Parameter Settings

Block-C parameters list

No.	Parameter	Min.	Max.	Default (Unit)	Function	Application				Ref. page
						Vf	VEC	PM	RWE	
C34 – Field network interface (PROFIBUS)										
0	Station number	0.	126.	1.	Set the station address. 01 to 126 (Slave station)	<input type="checkbox"/>	<input type="checkbox"/>	<input type="checkbox"/>		
1	Transmission error detection	1.	2	1.	Select the detection of transmission errors. =1: Not detected =2: Detected The "IO-9" error occurs when a transmission major fault is detected.	<input type="checkbox"/>	<input type="checkbox"/>	<input type="checkbox"/>		
2	HOLD/CLR/Emergency stop	0.	0.	2.	Set whether to hold or clear the command value or apply emergency stop when a transmission error (with recovery) occurs in the option I/F. =0:HOLD Maintain the command value at the current value. =1:Clear Clear all command values to 0. =2:Emergency stop Apply emergency stop * This parameter is not related to the transmission error detection C34-1. The "emergency stop" setting requires the operation resume operation after the fault is reset.	<input type="checkbox"/>	<input type="checkbox"/>	<input type="checkbox"/>		
3	Master timeout time	0.	100.	50.	Set the master timeout time. [0.1 s/LSB]	<input type="checkbox"/>	<input type="checkbox"/>	<input type="checkbox"/>		
6	Data range selection	0.	11.	0.	Select the data range for the transmission input/output data. Refer to the "Data Range Selection Table" for details.	<input type="checkbox"/>	<input type="checkbox"/>	<input type="checkbox"/>		
C34 – Field network interface (CC-Link)										
1	Transmission error detection	1.	2	1.	Select the detection of transmission errors. =1: Not detected =2: Detected The "IO-9" error occurs when a transmission major fault is detected.	<input type="checkbox"/>	<input type="checkbox"/>	<input type="checkbox"/>		
2	HOLD/CLR/Emergency stop	0.	0.	2.	Set whether to hold or clear the command value or apply emergency stop when a transmission error (with recovery) occurs in the option I/F. =0:HOLD Maintain the command value at the current value. =1:Clear Clear all command values to 0. =2:Emergency stop Apply emergency stop * This parameter is not related to the transmission error detection C34-1. The "emergency stop" setting requires the operation resume operation after the fault is reset. This is notified to the parent station when starting. HOLD/clear (including emergency stop)	<input type="checkbox"/>	<input type="checkbox"/>	<input type="checkbox"/>		
3	Master timeout time	0.	100.	50.	Set the master timeout time. [0.1 s/LSB]	<input type="checkbox"/>	<input type="checkbox"/>	<input type="checkbox"/>		
6	Data range selection	0.	11.	0.	Select the data range for the transmission input/output data. Refer to the "Data Range Selection Table" for details.	<input type="checkbox"/>	<input type="checkbox"/>	<input type="checkbox"/>		
7	CC-Link transmission version selection	1.	2.	1.	Set the version of the CC-Link transmission protocol. (For future use) (This parameter setting is invalid when using other communication options.) =1: Ver1 =2: Ver2	<input type="checkbox"/>	<input type="checkbox"/>	<input type="checkbox"/>		

6. Control Functions and Parameter Settings

Block-C parameters list

No.	Parameter	Min.	Max.	Default (Unit)	Function	Application				Ref. page
						V/f	VEC	PM	RWE	
C34 – Field network interface (IO link II)										
0	Station number	0.	126.	1.	Set the station address. 02 to 31 (Remote station)	○	○	○		
1	Transmission error detection	1.	2	1.	Select the detection of transmission errors. =1: Not detected =2: Detected The "IO-9" error occurs when a transmission major fault is detected.	○	○	○		
2	HOLD/CLR/Emergency stop	0.	0.	2.	Set whether to hold or clear the command value or apply emergency stop when a transmission error (with recovery) occurs in the option I/F. =0:HOLD Maintain the command value at the current value. =1:Clear Clear all command values to 0. =2:Emergency stop Apply emergency stop * This parameter is not related to the transmission error detection C34-1. The "emergency stop" setting requires the operation resume operation after the fault is reset.	○	○	○		
3	Master timeout time	0.	100.	50.	Set the master timeout time. [0.1 s/LSB]	○	○	○		
4	Transmission speed	1.	4.	1.	Set the IO link II metal transmission speed. (This parameter setting is invalid when using other communication options.) =1: 125 kbps =3: 500 kbps =2: 250 kbps =4: 1M bps	○	○	○		
5	Transmission size	1.	2.	1.	Set the IO link II transmission size. (This parameter setting is invalid when using other communication options.) =1: 16W =2: 32W	○	○	○		
6	Data range selection	0.	11.	0.	Select the data range for the transmission input/output data. Refer to the "Data Range Selection Table" for details.	○	○	○		

6. Control Functions and Parameter Settings

Block-C parameters list

No.	Parameter	Min.	Max.	Default (Unit)	Function	Application				Ref. page																																																																												
						V/F	VEC	PM	RWE																																																																													
C50 – Encoder setting																																																																																						
0	Encoder pulse divided output setting	1.	1023.	4.	The pulse input from the encoder can be divided in half, and output to an external source from PAOUT and PBOUT on the speed detection PCB. Adjust the setting value so that the output pulse is up to 70kHz.	○	○			6-158																																																																												
1	Encoder output pulse No. selection	1.	2.	1.	= 1 : 2-phase input = 2 : 1-phase input When using vector control with speed sensor, set whether the number of pulses input from the encoder is a 2-phase input or 1-phase input.	○	○		○	6-158																																																																												
2	Encoder AB advance direction selection	1.	2.	1.	Select the advance direction of the AB signal input from the encoder. =1: Forward =2: Reverse	○	○	○		6-158																																																																												
3	Encoder ABZ pulse type selection	0.	15.	0.	Set this only when the signal type cannot be selected with C50-2, C51-2. Take special care when setting.	○	○	○		6-159																																																																												
<table border="1" style="width: 100%; border-collapse: collapse;"> <thead> <tr> <th>Setting No.</th> <th>A-IN1 Non invert / Invert</th> <th>B-IN1 Non invert / Invert</th> <th>Z-IN Non invert / Invert</th> <th>AB inter-change</th> <th>Setting No.</th> <th>A-IN1 Non invert / Invert</th> <th>B-IN1 Non invert / Invert</th> <th>Z-IN Non invert / Invert</th> <th>AB inter-change</th> </tr> </thead> <tbody> <tr> <td>0</td> <td style="text-align: center;">-</td> <td style="text-align: center;">-</td> <td style="text-align: center;">-</td> <td rowspan="8" style="text-align: center;">No inter-change</td> <td>8</td> <td style="text-align: center;">-</td> <td style="text-align: center;">-</td> <td style="text-align: center;">-</td> <td rowspan="8" style="text-align: center;">AB inter-change</td> </tr> <tr> <td>1</td> <td style="text-align: center;">Invert</td> <td style="text-align: center;">-</td> <td style="text-align: center;">-</td> <td>9</td> <td style="text-align: center;">Invert</td> <td style="text-align: center;">-</td> <td style="text-align: center;">-</td> </tr> <tr> <td>2</td> <td style="text-align: center;">-</td> <td style="text-align: center;">Invert</td> <td style="text-align: center;">-</td> <td>10</td> <td style="text-align: center;">-</td> <td style="text-align: center;">Invert</td> <td style="text-align: center;">-</td> </tr> <tr> <td>3</td> <td style="text-align: center;">Invert</td> <td style="text-align: center;">Invert</td> <td style="text-align: center;">-</td> <td>11</td> <td style="text-align: center;">Invert</td> <td style="text-align: center;">Invert</td> <td style="text-align: center;">-</td> </tr> <tr> <td>4</td> <td style="text-align: center;">-</td> <td style="text-align: center;">-</td> <td style="text-align: center;">Invert</td> <td>12</td> <td style="text-align: center;">-</td> <td style="text-align: center;">-</td> <td style="text-align: center;">Invert</td> </tr> <tr> <td>5</td> <td style="text-align: center;">Invert</td> <td style="text-align: center;">-</td> <td style="text-align: center;">Invert</td> <td>13</td> <td style="text-align: center;">Invert</td> <td style="text-align: center;">-</td> <td style="text-align: center;">Invert</td> </tr> <tr> <td>6</td> <td style="text-align: center;">-</td> <td style="text-align: center;">Invert</td> <td style="text-align: center;">Invert</td> <td>14</td> <td style="text-align: center;">-</td> <td style="text-align: center;">Invert</td> <td style="text-align: center;">Invert</td> </tr> <tr> <td>7</td> <td style="text-align: center;">Invert</td> <td style="text-align: center;">Invert</td> <td style="text-align: center;">Invert</td> <td>15</td> <td style="text-align: center;">Invert</td> <td style="text-align: center;">Invert</td> <td style="text-align: center;">Invert</td> </tr> </tbody> </table>											Setting No.	A-IN1 Non invert / Invert	B-IN1 Non invert / Invert	Z-IN Non invert / Invert	AB inter-change	Setting No.	A-IN1 Non invert / Invert	B-IN1 Non invert / Invert	Z-IN Non invert / Invert	AB inter-change	0	-	-	-	No inter-change	8	-	-	-	AB inter-change	1	Invert	-	-	9	Invert	-	-	2	-	Invert	-	10	-	Invert	-	3	Invert	Invert	-	11	Invert	Invert	-	4	-	-	Invert	12	-	-	Invert	5	Invert	-	Invert	13	Invert	-	Invert	6	-	Invert	Invert	14	-	Invert	Invert	7	Invert	Invert	Invert	15	Invert	Invert	Invert
Setting No.	A-IN1 Non invert / Invert	B-IN1 Non invert / Invert	Z-IN Non invert / Invert	AB inter-change	Setting No.	A-IN1 Non invert / Invert	B-IN1 Non invert / Invert	Z-IN Non invert / Invert	AB inter-change																																																																													
0	-	-	-	No inter-change	8	-	-	-	AB inter-change																																																																													
1	Invert	-	-		9	Invert	-	-																																																																														
2	-	Invert	-		10	-	Invert	-																																																																														
3	Invert	Invert	-		11	Invert	Invert	-																																																																														
4	-	-	Invert		12	-	-	Invert																																																																														
5	Invert	-	Invert		13	Invert	-	Invert																																																																														
6	-	Invert	Invert		14	-	Invert	Invert																																																																														
7	Invert	Invert	Invert		15	Invert	Invert	Invert																																																																														

6. Control Functions and Parameter Settings

Block-C parameters list

No.	Parameter	Min.	Max.	Default (Unit)	Function	Application				Ref. page																																						
						V/f	VEC	PM	RWE																																							
C51 – Encoder setting (PM)																																																
0	Encoder selection	1.	4.	1.	Select the type of signal input from the encoder. =1: A, B, Z-phase + U, V, W-phase signal =2: A, B, Z-phase + serial absolute signal =3: A, B, Z-phase + U, V, W-phase signal (reduced wiring) =4: SIN, COS signal				<input type="radio"/>	6-159																																						
1	AB phase-Z phase type selection	0	1	0	=0: Normal =1: When the AB phase and Z phase edge is identical				<input type="radio"/>	6-160																																						
2	Encoder Z signal reversal	1.	2.	1.	Select whether to reverse the Z signal input from the encoder. =1: Do not reverse =2: Reverse				<input type="radio"/>	6-160																																						
3	Encoder UVW advance direction selection	1.	2.	1.	Select the advance direction of the UVW signal input from the encoder. =1: Forward =2: Reverse	<input type="radio"/>	<input type="radio"/>	<input type="radio"/>		6-160																																						
4	Z-IN → U phase winding phase angle	0.0	359.9	0.0 (°)	Electrical angle from Z-IN to U phase			<input type="radio"/>	<input type="radio"/>	6-161																																						
5	Z-IN → U phase angle	0.0	359.9	0.0 (°)	Electrical angle from Z-IN to u phase			<input type="radio"/>	<input type="radio"/>	6-162																																						
6	Encoder UVW pulse type selection	0	7	0	Set this only when the signal type cannot be selected with C51-3. Take special care when setting.				<input type="radio"/>	6-160																																						
<table border="1" style="width: 100%; border-collapse: collapse;"> <thead> <tr> <th>Setting No.</th> <th>U-IN Non invert / Invert</th> <th>V-IN Non invert / Invert</th> <th>W-IN Non invert / Invert</th> <th>UV inter- change</th> </tr> </thead> <tbody> <tr> <td>0</td> <td>–</td> <td>–</td> <td>–</td> <td rowspan="8" style="text-align: center;">No inter- change</td> </tr> <tr> <td>1</td> <td>Invert</td> <td>–</td> <td>–</td> </tr> <tr> <td>2</td> <td>–</td> <td>Invert</td> <td>–</td> </tr> <tr> <td>3</td> <td>Invert</td> <td>Invert</td> <td>–</td> </tr> <tr> <td>4</td> <td>–</td> <td>–</td> <td>Invert</td> </tr> <tr> <td>5</td> <td>Invert</td> <td>–</td> <td>Invert</td> </tr> <tr> <td>6</td> <td>–</td> <td>Invert</td> <td>Invert</td> </tr> <tr> <td>7</td> <td>Invert</td> <td>Invert</td> <td>Invert</td> </tr> </tbody> </table> <div style="margin-top: 10px;"> <p style="text-align: center;">During CCW rotation t</p> </div>											Setting No.	U-IN Non invert / Invert	V-IN Non invert / Invert	W-IN Non invert / Invert	UV inter- change	0	–	–	–	No inter- change	1	Invert	–	–	2	–	Invert	–	3	Invert	Invert	–	4	–	–	Invert	5	Invert	–	Invert	6	–	Invert	Invert	7	Invert	Invert	Invert
Setting No.	U-IN Non invert / Invert	V-IN Non invert / Invert	W-IN Non invert / Invert	UV inter- change																																												
0	–	–	–	No inter- change																																												
1	Invert	–	–																																													
2	–	Invert	–																																													
3	Invert	Invert	–																																													
4	–	–	Invert																																													
5	Invert	–	Invert																																													
6	–	Invert	Invert																																													
7	Invert	Invert	Invert																																													
7	UVW measurement start wait time [For reduced wiring ABZUVW]	0.	1000.	2. (ms)	When using the reduced wiring ABZUVW encoder, set the time to wait from the setting of the UVW signal to the measurement of UVW. The timer functions at a 2ms cycle, so set an integer-fold of 2.				<input type="radio"/>	<input type="radio"/>	6-163																																					
8	UVW measurement time [For reduced wiring ABZUVW]	0.	1000.	2. (ms)	When using the reduced wiring ABZUVW encoder, set the interval to measure the UVW signal. If UVW cannot be measured within this time, a fault will be output. The timer functions at a 2ms cycle, so set an integer-fold of 2.				<input type="radio"/>	<input type="radio"/>	6-163																																					
9	ABZ measurement start wait time [For reduced wiring ABZUVW]	0.	1000.	2. (ms)	When using the reduced wiring ABZUVW encoder, set the time to wait before starting control with the ABZ signal. The timer functions at a 2ms cycle, so set an integer-fold of 2.				<input type="radio"/>	<input type="radio"/>	6-163																																					

6. Control Functions and Parameter Settings

6-5 Block-U parameters

The block-U parameters are for the utility mode.

V/f : Indicates parameters that apply for V/f control (constant torque, variable torque) (C30-0: f0 = 1).

VEC : Indicates parameters that apply for IM speed sensor-less vector control and IM speed vector control with sensor (C30-0: f0 = 2, 3).

PM : Indicates parameters that apply for control mode with PM motor sensor (C30-0: f0 = 4).

RWE : Displays the parameters that can be changed during operation.

Reference page: The number of the page providing detailed explanations is indicated.

Block-U parameters (Utility mode) list

No.	Parameter	Min.	Max.	Default (Unit)	Function	Application				Ref. page
						V/f	VEC	PM	RWE	
U00 – Parameter Control										
0	Parameter copy function	0.	9999.	0.	<p>The parameter copy function is executed while the inverter is stopped.</p> <p>= 1001 : Save The parameter data is saved from the inverter to the operation panel.</p> <p>= 2002 : Load The parameter data is loaded from the operation panel to the inverter. If parameter data outside the setting range, such as for a different inverter capacity, could be loaded, the settings of the parameters not within the setting range may be uncertain. In this case, always turn the power OFF and ON once.</p> <p>If d. Et appears when the power is turned ON, enter D20-2 and set the uncertain data.</p> <p>= 3003 : Verify check The operation panel and inverter parameter data contents are verified and checked. If the parameters differ, EP. Et will appear.</p> <p>= 4004 : Clear The parameter data of operation panel is cleared.</p>	○	○	○		6-164
1	Password No. setting	0.	9999.	0.	When C09-0 is locked, it can be unlocked by inputting the 4-digit parameter set with C28-0 in this parameter.	○	○	○		6-164

6. Control Functions and Parameter Settings

Block-U parameter built-in PLC function settings

No.	Parameter	Min.	Max.	Default (Unit)	Function	Application				Ref. page
						Vf	VEC	PM	RWE	
U10 – Built-in PLC setting										
0	No. of execution banks	0.	5.	0.	Set the number of banks to be executed at 1 bank/2ms. The built-in PLC is turned OFF when 1 is set. If a fault (CPU.B) occurs in the built-in PLC, 0 is forcibly set. Confirm the built-in PLC command and then set U10-0 again.	<input type="checkbox"/>	<input type="checkbox"/>	<input type="checkbox"/>	<input type="checkbox"/>	6-164
1	Built-in PLC parameter 1	0.	FFFF.	0. (hex)	Set the user parameters which can be used by the built-in PLC.	<input type="checkbox"/>	<input type="checkbox"/>	<input type="checkbox"/>	<input type="checkbox"/>	6-164
2	Built-in PLC parameter 1	0.	FFFF.	0. (hex)		<input type="checkbox"/>	<input type="checkbox"/>	<input type="checkbox"/>	<input type="checkbox"/>	6-164
3	Built-in PLC parameter 1	0.	FFFF.	0. (hex)		<input type="checkbox"/>	<input type="checkbox"/>	<input type="checkbox"/>	<input type="checkbox"/>	6-164
4	Built-in PLC parameter 1	0.	FFFF.	0. (hex)		<input type="checkbox"/>	<input type="checkbox"/>	<input type="checkbox"/>	<input type="checkbox"/>	6-164
5	Built-in PLC parameter 1	0.	FFFF.	0. (hex)		<input type="checkbox"/>	<input type="checkbox"/>	<input type="checkbox"/>	<input type="checkbox"/>	6-164
6	Built-in PLC parameter 1	0.	FFFF.	0. (hex)		<input type="checkbox"/>	<input type="checkbox"/>	<input type="checkbox"/>	<input type="checkbox"/>	6-164
7	Built-in PLC parameter 1	0.	FFFF.	0. (hex)		<input type="checkbox"/>	<input type="checkbox"/>	<input type="checkbox"/>	<input type="checkbox"/>	6-164
8	Built-in PLC parameter 1	0.	FFFF.	0. (hex)		<input type="checkbox"/>	<input type="checkbox"/>	<input type="checkbox"/>	<input type="checkbox"/>	6-164
U20 – Built-in PLC command bank A										
0	Command 0-0	0.	FFFF.	0. (hex)	Set the built-in PLC command. The commands are executed in order from smallest number.	<input type="checkbox"/>	<input type="checkbox"/>	<input type="checkbox"/>	<input type="checkbox"/>	6-165
1	Command 0-1	0.	FFFF.	0. (hex)	This is valid when U10-0 is 1 or more.	<input type="checkbox"/>	<input type="checkbox"/>	<input type="checkbox"/>	<input type="checkbox"/>	6-165
2	Command 0-2	0.	FFFF.	0. (hex)		<input type="checkbox"/>	<input type="checkbox"/>	<input type="checkbox"/>	<input type="checkbox"/>	6-165
3	Command 0-3	0.	FFFF.	0. (hex)		<input type="checkbox"/>	<input type="checkbox"/>	<input type="checkbox"/>	<input type="checkbox"/>	6-165
4	Command 0-4	0.	FFFF.	0. (hex)		<input type="checkbox"/>	<input type="checkbox"/>	<input type="checkbox"/>	<input type="checkbox"/>	6-165
5	Command 0-5	0.	FFFF.	0. (hex)		<input type="checkbox"/>	<input type="checkbox"/>	<input type="checkbox"/>	<input type="checkbox"/>	6-165
6	Command 0-6	0.	FFFF.	0. (hex)		<input type="checkbox"/>	<input type="checkbox"/>	<input type="checkbox"/>	<input type="checkbox"/>	6-165
7	Command 0-7	0.	FFFF.	0. (hex)		<input type="checkbox"/>	<input type="checkbox"/>	<input type="checkbox"/>	<input type="checkbox"/>	6-165
U21 – Built-in PLC command bank A										
0	Command 1-0	0.	FFFF.	0. (hex)	Set the user parameters which can be used by the built-in PLC.	<input type="checkbox"/>	<input type="checkbox"/>	<input type="checkbox"/>	<input type="checkbox"/>	6-165
1	Command 1-1	0.	FFFF.	0. (hex)		<input type="checkbox"/>	<input type="checkbox"/>	<input type="checkbox"/>	<input type="checkbox"/>	6-165
2	Command 1-2	0.	FFFF.	0. (hex)		<input type="checkbox"/>	<input type="checkbox"/>	<input type="checkbox"/>	<input type="checkbox"/>	6-165
3	Command 1-3	0.	FFFF.	0. (hex)		<input type="checkbox"/>	<input type="checkbox"/>	<input type="checkbox"/>	<input type="checkbox"/>	6-165
4	Command 1-4	0.	FFFF.	0. (hex)		<input type="checkbox"/>	<input type="checkbox"/>	<input type="checkbox"/>	<input type="checkbox"/>	6-165
5	Command 1-5	0.	FFFF.	0. (hex)		<input type="checkbox"/>	<input type="checkbox"/>	<input type="checkbox"/>	<input type="checkbox"/>	6-165
6	Command 1-6	0.	FFFF.	0. (hex)		<input type="checkbox"/>	<input type="checkbox"/>	<input type="checkbox"/>	<input type="checkbox"/>	6-165
7	Command 1-7	0.	FFFF.	0. (hex)		<input type="checkbox"/>	<input type="checkbox"/>	<input type="checkbox"/>	<input type="checkbox"/>	6-165

6. Control Functions and Parameter Settings

Block-U parameter built-in PLC function settings

No.	Parameter	Min.	Max.	Default (Unit)	Function	Application				Ref. page
						Vf	VEC	PM	RWE	
U22 – Built-in PLC command bank A										
0	Command 2-0	0.	FFFF.	0. (hex)	Set the built-in PLC command. The commands are executed in order from smallest number.	<input type="checkbox"/>	<input type="checkbox"/>	<input type="checkbox"/>	<input type="checkbox"/>	6-165
1	Command 2-1	0.	FFFF.	0. (hex)	This is valid when U10-0 is 1 or more.	<input type="checkbox"/>	<input type="checkbox"/>	<input type="checkbox"/>	<input type="checkbox"/>	6-165
2	Command 2-2	0.	FFFF.	0. (hex)		<input type="checkbox"/>	<input type="checkbox"/>	<input type="checkbox"/>	<input type="checkbox"/>	6-165
3	Command 2-3	0.	FFFF.	0. (hex)		<input type="checkbox"/>	<input type="checkbox"/>	<input type="checkbox"/>	<input type="checkbox"/>	6-165
4	Command 2-4	0.	FFFF.	0. (hex)		<input type="checkbox"/>	<input type="checkbox"/>	<input type="checkbox"/>	<input type="checkbox"/>	6-165
5	Command 2-5	0.	FFFF.	0. (hex)		<input type="checkbox"/>	<input type="checkbox"/>	<input type="checkbox"/>	<input type="checkbox"/>	6-165
6	Command 2-6	0.	FFFF.	0. (hex)		<input type="checkbox"/>	<input type="checkbox"/>	<input type="checkbox"/>	<input type="checkbox"/>	6-165
7	Command 2-7	0.	FFFF.	0. (hex)		<input type="checkbox"/>	<input type="checkbox"/>	<input type="checkbox"/>	<input type="checkbox"/>	6-165
U23 – Built-in PLC command bank A										
0	Command 3-0	0.	FFFF.	0. (hex)	Set the built-in PLC command. The commands are executed in order from smallest number.	<input type="checkbox"/>	<input type="checkbox"/>	<input type="checkbox"/>	<input type="checkbox"/>	6-165
1	Command 3-1	0.	FFFF.	0. (hex)	This is valid when U10-0 is 1 or more.	<input type="checkbox"/>	<input type="checkbox"/>	<input type="checkbox"/>	<input type="checkbox"/>	6-165
2	Command 3-2	0.	FFFF.	0. (hex)		<input type="checkbox"/>	<input type="checkbox"/>	<input type="checkbox"/>	<input type="checkbox"/>	6-165
3	Command 3-3	0.	FFFF.	0. (hex)		<input type="checkbox"/>	<input type="checkbox"/>	<input type="checkbox"/>	<input type="checkbox"/>	6-165
4	Command 3-4	0.	FFFF.	0. (hex)		<input type="checkbox"/>	<input type="checkbox"/>	<input type="checkbox"/>	<input type="checkbox"/>	6-165
5	Command 3-5	0.	FFFF.	0. (hex)		<input type="checkbox"/>	<input type="checkbox"/>	<input type="checkbox"/>	<input type="checkbox"/>	6-165
6	Command 3-6	0.	FFFF.	0. (hex)		<input type="checkbox"/>	<input type="checkbox"/>	<input type="checkbox"/>	<input type="checkbox"/>	6-165
7	Command 3-7	0.	FFFF.	0. (hex)		<input type="checkbox"/>	<input type="checkbox"/>	<input type="checkbox"/>	<input type="checkbox"/>	6-165
U24 – Built-in PLC command bank A										
0	Command 4-0	0.	FFFF.	0. (hex)	Set the user parameters which can be used by the built-in PLC.	<input type="checkbox"/>	<input type="checkbox"/>	<input type="checkbox"/>	<input type="checkbox"/>	6-165
1	Command 4-1	0.	FFFF.	0. (hex)		<input type="checkbox"/>	<input type="checkbox"/>	<input type="checkbox"/>	<input type="checkbox"/>	6-165
2	Command 4-2	0.	FFFF.	0. (hex)		<input type="checkbox"/>	<input type="checkbox"/>	<input type="checkbox"/>	<input type="checkbox"/>	6-165
3	Command 4-3	0.	FFFF.	0. (hex)		<input type="checkbox"/>	<input type="checkbox"/>	<input type="checkbox"/>	<input type="checkbox"/>	6-165
4	Command 4-4	0.	FFFF.	0. (hex)		<input type="checkbox"/>	<input type="checkbox"/>	<input type="checkbox"/>	<input type="checkbox"/>	6-165
5	Command 4-5	0.	FFFF.	0. (hex)		<input type="checkbox"/>	<input type="checkbox"/>	<input type="checkbox"/>	<input type="checkbox"/>	6-165
6	Command 4-6	0.	FFFF.	0. (hex)		<input type="checkbox"/>	<input type="checkbox"/>	<input type="checkbox"/>	<input type="checkbox"/>	6-165
7	Command 4-7	0.	FFFF.	0. (hex)		<input type="checkbox"/>	<input type="checkbox"/>	<input type="checkbox"/>	<input type="checkbox"/>	6-165

6. Control Functions and Parameter Settings

Block-U parameter built-in PLC function settings

No.	Parameter	Min.	Max.	Default (Unit)	Function	Application				Ref. page
						Vf	VEC	PM	RWE	
U25 – Built-in PLC command bank A										
0	Command 5-0	0.	FFFF.	0. (hex)	Set the built-in PLC command. The commands are executed in order from smallest number.	<input type="checkbox"/>	<input type="checkbox"/>	<input type="checkbox"/>	<input type="checkbox"/>	6-165
1	Command 5-1	0.	FFFF.	0. (hex)	This is valid when U10-0 is 1 or more.	<input type="checkbox"/>	<input type="checkbox"/>	<input type="checkbox"/>	<input type="checkbox"/>	6-165
2	Command 5-2	0.	FFFF.	0. (hex)		<input type="checkbox"/>	<input type="checkbox"/>	<input type="checkbox"/>	<input type="checkbox"/>	6-165
3	Command 5-3	0.	FFFF.	0. (hex)		<input type="checkbox"/>	<input type="checkbox"/>	<input type="checkbox"/>	<input type="checkbox"/>	6-165
4	Command 5-4	0.	FFFF.	0. (hex)		<input type="checkbox"/>	<input type="checkbox"/>	<input type="checkbox"/>	<input type="checkbox"/>	6-165
5	Command 5-5	0.	FFFF.	0. (hex)		<input type="checkbox"/>	<input type="checkbox"/>	<input type="checkbox"/>	<input type="checkbox"/>	6-165
6	Command 5-6	0.	FFFF.	0. (hex)		<input type="checkbox"/>	<input type="checkbox"/>	<input type="checkbox"/>	<input type="checkbox"/>	6-165
7	Command 5-7	0.	FFFF.	0. (hex)		<input type="checkbox"/>	<input type="checkbox"/>	<input type="checkbox"/>	<input type="checkbox"/>	6-165
U26 – Built-in PLC command bank A										
0	Command 6-0	0.	FFFF.	0. (hex)	Set the built-in PLC command. The commands are executed in order from smallest number.	<input type="checkbox"/>	<input type="checkbox"/>	<input type="checkbox"/>	<input type="checkbox"/>	6-165
1	Command 6-1	0.	FFFF.	0. (hex)	This is valid when U10-0 is 1 or more.	<input type="checkbox"/>	<input type="checkbox"/>	<input type="checkbox"/>	<input type="checkbox"/>	6-165
2	Command 6-2	0.	FFFF.	0. (hex)		<input type="checkbox"/>	<input type="checkbox"/>	<input type="checkbox"/>	<input type="checkbox"/>	6-165
3	Command 6-3	0.	FFFF.	0. (hex)		<input type="checkbox"/>	<input type="checkbox"/>	<input type="checkbox"/>	<input type="checkbox"/>	6-165
4	Command 6-4	0.	FFFF.	0. (hex)		<input type="checkbox"/>	<input type="checkbox"/>	<input type="checkbox"/>	<input type="checkbox"/>	6-165
5	Command 6-5	0.	FFFF.	0. (hex)		<input type="checkbox"/>	<input type="checkbox"/>	<input type="checkbox"/>	<input type="checkbox"/>	6-165
6	Command 6-6	0.	FFFF.	0. (hex)		<input type="checkbox"/>	<input type="checkbox"/>	<input type="checkbox"/>	<input type="checkbox"/>	6-165
7	Command 6-7	0.	FFFF.	0. (hex)		<input type="checkbox"/>	<input type="checkbox"/>	<input type="checkbox"/>	<input type="checkbox"/>	6-165
U27 – Built-in PLC command bank A										
0	Command 7-0	0.	FFFF.	0. (hex)	Set the user parameters which can be used by the built-in PLC.	<input type="checkbox"/>	<input type="checkbox"/>	<input type="checkbox"/>	<input type="checkbox"/>	6-165
1	Command 7-1	0.	FFFF.	0. (hex)		<input type="checkbox"/>	<input type="checkbox"/>	<input type="checkbox"/>	<input type="checkbox"/>	6-165
2	Command 7-2	0.	FFFF.	0. (hex)		<input type="checkbox"/>	<input type="checkbox"/>	<input type="checkbox"/>	<input type="checkbox"/>	6-165
3	Command 7-3	0.	FFFF.	0. (hex)		<input type="checkbox"/>	<input type="checkbox"/>	<input type="checkbox"/>	<input type="checkbox"/>	6-165
4	Command 7-4	0.	FFFF.	0. (hex)		<input type="checkbox"/>	<input type="checkbox"/>	<input type="checkbox"/>	<input type="checkbox"/>	6-165
5	Command 7-5	0.	FFFF.	0. (hex)		<input type="checkbox"/>	<input type="checkbox"/>	<input type="checkbox"/>	<input type="checkbox"/>	6-165
6	Command 7-6	0.	FFFF.	0. (hex)		<input type="checkbox"/>	<input type="checkbox"/>	<input type="checkbox"/>	<input type="checkbox"/>	6-165
7	Command 7-7	0.	FFFF.	0. (hex)		<input type="checkbox"/>	<input type="checkbox"/>	<input type="checkbox"/>	<input type="checkbox"/>	6-165

6. Control Functions and Parameter Settings

Block-U parameter built-in PLC function settings

No.	Parameter	Min.	Max.	Default (Unit)	Function	Application				Ref. page
						Vf	VEC	PM	RWE	
U30 – Built-in PLC command bank B										
0	Command 0-0	0.	FFFF.	0. (hex)	Set the built-in PLC command. The commands are executed in order from smallest number.	<input type="checkbox"/>	<input type="checkbox"/>	<input type="checkbox"/>	<input type="checkbox"/>	6-165
1	Command 0-1	0.	FFFF.	0. (hex)	This is valid when U10-0 is 2 or more.	<input type="checkbox"/>	<input type="checkbox"/>	<input type="checkbox"/>	<input type="checkbox"/>	6-165
2	Command 0-2	0.	FFFF.	0. (hex)		<input type="checkbox"/>	<input type="checkbox"/>	<input type="checkbox"/>	<input type="checkbox"/>	6-165
3	Command 0-3	0.	FFFF.	0. (hex)		<input type="checkbox"/>	<input type="checkbox"/>	<input type="checkbox"/>	<input type="checkbox"/>	6-165
4	Command 0-4	0.	FFFF.	0. (hex)		<input type="checkbox"/>	<input type="checkbox"/>	<input type="checkbox"/>	<input type="checkbox"/>	6-165
5	Command 0-5	0.	FFFF.	0. (hex)		<input type="checkbox"/>	<input type="checkbox"/>	<input type="checkbox"/>	<input type="checkbox"/>	6-165
6	Command 0-6	0.	FFFF.	0. (hex)		<input type="checkbox"/>	<input type="checkbox"/>	<input type="checkbox"/>	<input type="checkbox"/>	6-165
7	Command 0-7	0.	FFFF.	0. (hex)		<input type="checkbox"/>	<input type="checkbox"/>	<input type="checkbox"/>	<input type="checkbox"/>	6-165
U31 – Built-in PLC command bank B										
0	Command 1-0	0.	FFFF.	0. (hex)	Set the built-in PLC command. The commands are executed in order from smallest number.	<input type="checkbox"/>	<input type="checkbox"/>	<input type="checkbox"/>	<input type="checkbox"/>	6-165
1	Command 1-1	0.	FFFF.	0. (hex)	This is valid when U10-0 is 2 or more.	<input type="checkbox"/>	<input type="checkbox"/>	<input type="checkbox"/>	<input type="checkbox"/>	6-165
2	Command 1-2	0.	FFFF.	0. (hex)		<input type="checkbox"/>	<input type="checkbox"/>	<input type="checkbox"/>	<input type="checkbox"/>	6-165
3	Command 1-3	0.	FFFF.	0. (hex)		<input type="checkbox"/>	<input type="checkbox"/>	<input type="checkbox"/>	<input type="checkbox"/>	6-165
4	Command 1-4	0.	FFFF.	0. (hex)		<input type="checkbox"/>	<input type="checkbox"/>	<input type="checkbox"/>	<input type="checkbox"/>	6-165
5	Command 1-5	0.	FFFF.	0. (hex)		<input type="checkbox"/>	<input type="checkbox"/>	<input type="checkbox"/>	<input type="checkbox"/>	6-165
6	Command 1-6	0.	FFFF.	0. (hex)		<input type="checkbox"/>	<input type="checkbox"/>	<input type="checkbox"/>	<input type="checkbox"/>	6-165
7	Command 1-7	0.	FFFF.	0. (hex)		<input type="checkbox"/>	<input type="checkbox"/>	<input type="checkbox"/>	<input type="checkbox"/>	6-165
U32 – Built-in PLC command bank B										
0	Command 2-0	0.	FFFF.	0. (hex)	Set the user parameters which can be used by the built-in PLC.	<input type="checkbox"/>	<input type="checkbox"/>	<input type="checkbox"/>	<input type="checkbox"/>	6-165
1	Command 2-1	0.	FFFF.	0. (hex)		<input type="checkbox"/>	<input type="checkbox"/>	<input type="checkbox"/>	<input type="checkbox"/>	6-165
2	Command 2-2	0.	FFFF.	0. (hex)		<input type="checkbox"/>	<input type="checkbox"/>	<input type="checkbox"/>	<input type="checkbox"/>	6-165
3	Command 2-3	0.	FFFF.	0. (hex)		<input type="checkbox"/>	<input type="checkbox"/>	<input type="checkbox"/>	<input type="checkbox"/>	6-165
4	Command 2-4	0.	FFFF.	0. (hex)		<input type="checkbox"/>	<input type="checkbox"/>	<input type="checkbox"/>	<input type="checkbox"/>	6-165
5	Command 2-5	0.	FFFF.	0. (hex)		<input type="checkbox"/>	<input type="checkbox"/>	<input type="checkbox"/>	<input type="checkbox"/>	6-165
6	Command 2-6	0.	FFFF.	0. (hex)		<input type="checkbox"/>	<input type="checkbox"/>	<input type="checkbox"/>	<input type="checkbox"/>	6-165
7	Command 2-7	0.	FFFF.	0. (hex)		<input type="checkbox"/>	<input type="checkbox"/>	<input type="checkbox"/>	<input type="checkbox"/>	6-165

6. Control Functions and Parameter Settings

Block-U parameter built-in PLC function settings

No.	Parameter	Min.	Max.	Default (Unit)	Function	Application				Ref. page
						Vf	VEC	PM	RWE	
U33 – Built-in PLC command bank B										
0	Command 3-0	0.	FFFF.	0. (hex)	Set the built-in PLC command. The commands are executed in order from smallest number.	<input type="checkbox"/>	<input type="checkbox"/>	<input type="checkbox"/>	<input type="checkbox"/>	6-165
1	Command 3-1	0.	FFFF.	0. (hex)	This is valid when U10-0 is 2 or more.	<input type="checkbox"/>	<input type="checkbox"/>	<input type="checkbox"/>	<input type="checkbox"/>	6-165
2	Command 3-2	0.	FFFF.	0. (hex)		<input type="checkbox"/>	<input type="checkbox"/>	<input type="checkbox"/>	<input type="checkbox"/>	6-165
3	Command 3-3	0.	FFFF.	0. (hex)		<input type="checkbox"/>	<input type="checkbox"/>	<input type="checkbox"/>	<input type="checkbox"/>	6-165
4	Command 3-4	0.	FFFF.	0. (hex)		<input type="checkbox"/>	<input type="checkbox"/>	<input type="checkbox"/>	<input type="checkbox"/>	6-165
5	Command 3-5	0.	FFFF.	0. (hex)		<input type="checkbox"/>	<input type="checkbox"/>	<input type="checkbox"/>	<input type="checkbox"/>	6-165
6	Command 3-6	0.	FFFF.	0. (hex)		<input type="checkbox"/>	<input type="checkbox"/>	<input type="checkbox"/>	<input type="checkbox"/>	6-165
7	Command 3-7	0.	FFFF.	0. (hex)		<input type="checkbox"/>	<input type="checkbox"/>	<input type="checkbox"/>	<input type="checkbox"/>	6-165
U34 – Built-in PLC command bank B										
0	Command 4-0	0.	FFFF.	0. (hex)	Set the built-in PLC command. The commands are executed in order from smallest number.	<input type="checkbox"/>	<input type="checkbox"/>	<input type="checkbox"/>	<input type="checkbox"/>	6-165
1	Command 4-1	0.	FFFF.	0. (hex)	This is valid when U10-0 is 2 or more.	<input type="checkbox"/>	<input type="checkbox"/>	<input type="checkbox"/>	<input type="checkbox"/>	6-165
2	Command 4-2	0.	FFFF.	0. (hex)		<input type="checkbox"/>	<input type="checkbox"/>	<input type="checkbox"/>	<input type="checkbox"/>	6-165
3	Command 4-3	0.	FFFF.	0. (hex)		<input type="checkbox"/>	<input type="checkbox"/>	<input type="checkbox"/>	<input type="checkbox"/>	6-165
4	Command 4-4	0.	FFFF.	0. (hex)		<input type="checkbox"/>	<input type="checkbox"/>	<input type="checkbox"/>	<input type="checkbox"/>	6-165
5	Command 4-5	0.	FFFF.	0. (hex)		<input type="checkbox"/>	<input type="checkbox"/>	<input type="checkbox"/>	<input type="checkbox"/>	6-165
6	Command 4-6	0.	FFFF.	0. (hex)		<input type="checkbox"/>	<input type="checkbox"/>	<input type="checkbox"/>	<input type="checkbox"/>	6-165
7	Command 4-7	0.	FFFF.	0. (hex)		<input type="checkbox"/>	<input type="checkbox"/>	<input type="checkbox"/>	<input type="checkbox"/>	6-165
U35 – Built-in PLC command bank B										
0	Command 5-0	0.	FFFF.	0. (hex)	Set the user parameters which can be used by the built-in PLC.	<input type="checkbox"/>	<input type="checkbox"/>	<input type="checkbox"/>	<input type="checkbox"/>	6-165
1	Command 5-1	0.	FFFF.	0. (hex)		<input type="checkbox"/>	<input type="checkbox"/>	<input type="checkbox"/>	<input type="checkbox"/>	6-165
2	Command 5-2	0.	FFFF.	0. (hex)		<input type="checkbox"/>	<input type="checkbox"/>	<input type="checkbox"/>	<input type="checkbox"/>	6-165
3	Command 5-3	0.	FFFF.	0. (hex)		<input type="checkbox"/>	<input type="checkbox"/>	<input type="checkbox"/>	<input type="checkbox"/>	6-165
4	Command 5-4	0.	FFFF.	0. (hex)		<input type="checkbox"/>	<input type="checkbox"/>	<input type="checkbox"/>	<input type="checkbox"/>	6-165
5	Command 5-5	0.	FFFF.	0. (hex)		<input type="checkbox"/>	<input type="checkbox"/>	<input type="checkbox"/>	<input type="checkbox"/>	6-165
6	Command 5-6	0.	FFFF.	0. (hex)		<input type="checkbox"/>	<input type="checkbox"/>	<input type="checkbox"/>	<input type="checkbox"/>	6-165
7	Command 5-7	0.	FFFF.	0. (hex)		<input type="checkbox"/>	<input type="checkbox"/>	<input type="checkbox"/>	<input type="checkbox"/>	6-165

6. Control Functions and Parameter Settings

Block-U parameter built-in PLC function settings

No.	Parameter	Min.	Max.	Default (Unit)	Function	Application				Ref. page
						Vf	VEC	PM	RWE	
U36 – Built-in PLC command bank B										
0	Command 6-0	0.	FFFF.	0. (hex)	Set the built-in PLC command. The commands are executed in order from smallest number.	<input type="radio"/>	<input type="radio"/>	<input type="radio"/>	<input type="radio"/>	6-165
1	Command 6-1	0.	FFFF.	0. (hex)	This is valid when U10-0 is 2 or more.	<input type="radio"/>	<input type="radio"/>	<input type="radio"/>	<input type="radio"/>	6-165
2	Command 6-2	0.	FFFF.	0. (hex)		<input type="radio"/>	<input type="radio"/>	<input type="radio"/>	<input type="radio"/>	6-165
3	Command 6-3	0.	FFFF.	0. (hex)		<input type="radio"/>	<input type="radio"/>	<input type="radio"/>	<input type="radio"/>	6-165
4	Command 6-4	0.	FFFF.	0. (hex)		<input type="radio"/>	<input type="radio"/>	<input type="radio"/>	<input type="radio"/>	6-165
5	Command 6-5	0.	FFFF.	0. (hex)		<input type="radio"/>	<input type="radio"/>	<input type="radio"/>	<input type="radio"/>	6-165
6	Command 6-6	0.	FFFF.	0. (hex)		<input type="radio"/>	<input type="radio"/>	<input type="radio"/>	<input type="radio"/>	6-165
7	Command 6-7	0.	FFFF.	0. (hex)		<input type="radio"/>	<input type="radio"/>	<input type="radio"/>	<input type="radio"/>	6-165
U37 – Built-in PLC command bank B										
0	Command 7-0	0.	FFFF.	0. (hex)	Set the built-in PLC command. The commands are executed in order from smallest number.	<input type="radio"/>	<input type="radio"/>	<input type="radio"/>	<input type="radio"/>	6-165
1	Command 7-1	0.	FFFF.	0. (hex)	This is valid when U10-0 is 2 or more.	<input type="radio"/>	<input type="radio"/>	<input type="radio"/>	<input type="radio"/>	6-165
2	Command 7-2	0.	FFFF.	0. (hex)		<input type="radio"/>	<input type="radio"/>	<input type="radio"/>	<input type="radio"/>	6-165
3	Command 7-3	0.	FFFF.	0. (hex)		<input type="radio"/>	<input type="radio"/>	<input type="radio"/>	<input type="radio"/>	6-165
4	Command 7-4	0.	FFFF.	0. (hex)		<input type="radio"/>	<input type="radio"/>	<input type="radio"/>	<input type="radio"/>	6-165
5	Command 7-5	0.	FFFF.	0. (hex)		<input type="radio"/>	<input type="radio"/>	<input type="radio"/>	<input type="radio"/>	6-165
6	Command 7-6	0.	FFFF.	0. (hex)		<input type="radio"/>	<input type="radio"/>	<input type="radio"/>	<input type="radio"/>	6-165
7	Command 7-7	0.	FFFF.	0. (hex)		<input type="radio"/>	<input type="radio"/>	<input type="radio"/>	<input type="radio"/>	6-165

6. Control Functions and Parameter Settings

Block-U parameter built-in PLC function settings

No.	Parameter	Min.	Max.	Default (Unit)	Function	Application				Ref. page
						Vf	VEC	PM	RWE	
U40 – Built-in PLC command bank C										
0	Command 0-0	0.	FFFF.	0. (hex)	Set the built-in PLC command. The commands are executed in order from smallest number.	<input type="checkbox"/>	<input type="checkbox"/>	<input type="checkbox"/>	<input type="checkbox"/>	6-165
1	Command 0-1	0.	FFFF.	0. (hex)	This is valid when U10-0 is 3 or more.	<input type="checkbox"/>	<input type="checkbox"/>	<input type="checkbox"/>	<input type="checkbox"/>	6-165
2	Command 0-2	0.	FFFF.	0. (hex)		<input type="checkbox"/>	<input type="checkbox"/>	<input type="checkbox"/>	<input type="checkbox"/>	6-165
3	Command 0-3	0.	FFFF.	0. (hex)		<input type="checkbox"/>	<input type="checkbox"/>	<input type="checkbox"/>	<input type="checkbox"/>	6-165
4	Command 0-4	0.	FFFF.	0. (hex)		<input type="checkbox"/>	<input type="checkbox"/>	<input type="checkbox"/>	<input type="checkbox"/>	6-165
5	Command 0-5	0.	FFFF.	0. (hex)		<input type="checkbox"/>	<input type="checkbox"/>	<input type="checkbox"/>	<input type="checkbox"/>	6-165
6	Command 0-6	0.	FFFF.	0. (hex)		<input type="checkbox"/>	<input type="checkbox"/>	<input type="checkbox"/>	<input type="checkbox"/>	6-165
7	Command 0-7	0.	FFFF.	0. (hex)		<input type="checkbox"/>	<input type="checkbox"/>	<input type="checkbox"/>	<input type="checkbox"/>	6-165
U41 – Built-in PLC command bank C										
0	Command 1-0	0.	FFFF.	0. (hex)	Set the built-in PLC command. The commands are executed in order from smallest number.	<input type="checkbox"/>	<input type="checkbox"/>	<input type="checkbox"/>	<input type="checkbox"/>	6-165
1	Command 1-1	0.	FFFF.	0. (hex)	This is valid when U10-0 is 3 or more.	<input type="checkbox"/>	<input type="checkbox"/>	<input type="checkbox"/>	<input type="checkbox"/>	6-165
2	Command 1-2	0.	FFFF.	0. (hex)		<input type="checkbox"/>	<input type="checkbox"/>	<input type="checkbox"/>	<input type="checkbox"/>	6-165
3	Command 1-3	0.	FFFF.	0. (hex)		<input type="checkbox"/>	<input type="checkbox"/>	<input type="checkbox"/>	<input type="checkbox"/>	6-165
4	Command 1-4	0.	FFFF.	0. (hex)		<input type="checkbox"/>	<input type="checkbox"/>	<input type="checkbox"/>	<input type="checkbox"/>	6-165
5	Command 1-5	0.	FFFF.	0. (hex)		<input type="checkbox"/>	<input type="checkbox"/>	<input type="checkbox"/>	<input type="checkbox"/>	6-165
6	Command 1-6	0.	FFFF.	0. (hex)		<input type="checkbox"/>	<input type="checkbox"/>	<input type="checkbox"/>	<input type="checkbox"/>	6-165
7	Command 1-7	0.	FFFF.	0. (hex)		<input type="checkbox"/>	<input type="checkbox"/>	<input type="checkbox"/>	<input type="checkbox"/>	6-165
U42 – Built-in PLC command bank C										
0	Command 2-0	0.	FFFF.	0. (hex)	Set the user parameters which can be used by the built-in PLC.	<input type="checkbox"/>	<input type="checkbox"/>	<input type="checkbox"/>	<input type="checkbox"/>	6-165
1	Command 2-1	0.	FFFF.	0. (hex)		<input type="checkbox"/>	<input type="checkbox"/>	<input type="checkbox"/>	<input type="checkbox"/>	6-165
2	Command 2-2	0.	FFFF.	0. (hex)		<input type="checkbox"/>	<input type="checkbox"/>	<input type="checkbox"/>	<input type="checkbox"/>	6-165
3	Command 2-3	0.	FFFF.	0. (hex)		<input type="checkbox"/>	<input type="checkbox"/>	<input type="checkbox"/>	<input type="checkbox"/>	6-165
4	Command 2-4	0.	FFFF.	0. (hex)		<input type="checkbox"/>	<input type="checkbox"/>	<input type="checkbox"/>	<input type="checkbox"/>	6-165
5	Command 2-5	0.	FFFF.	0. (hex)		<input type="checkbox"/>	<input type="checkbox"/>	<input type="checkbox"/>	<input type="checkbox"/>	6-165
6	Command 2-6	0.	FFFF.	0. (hex)		<input type="checkbox"/>	<input type="checkbox"/>	<input type="checkbox"/>	<input type="checkbox"/>	6-165
7	Command 2-7	0.	FFFF.	0. (hex)		<input type="checkbox"/>	<input type="checkbox"/>	<input type="checkbox"/>	<input type="checkbox"/>	6-165

6. Control Functions and Parameter Settings

Block-U parameter built-in PLC function settings

No.	Parameter	Min.	Max.	Default (Unit)	Function	Application				Ref. page
						Vf	VEC	PM	RWE	
U43 – Built-in PLC command bank C										
0	Command 3-0	0.	FFFF.	0. (hex)	Set the built-in PLC command. The commands are executed in order from smallest number.	<input type="checkbox"/>	<input type="checkbox"/>	<input type="checkbox"/>	<input type="checkbox"/>	6-165
1	Command 3-1	0.	FFFF.	0. (hex)	This is valid when U10-0 is 3 or more.	<input type="checkbox"/>	<input type="checkbox"/>	<input type="checkbox"/>	<input type="checkbox"/>	6-165
2	Command 3-2	0.	FFFF.	0. (hex)		<input type="checkbox"/>	<input type="checkbox"/>	<input type="checkbox"/>	<input type="checkbox"/>	6-165
3	Command 3-3	0.	FFFF.	0. (hex)		<input type="checkbox"/>	<input type="checkbox"/>	<input type="checkbox"/>	<input type="checkbox"/>	6-165
4	Command 3-4	0.	FFFF.	0. (hex)		<input type="checkbox"/>	<input type="checkbox"/>	<input type="checkbox"/>	<input type="checkbox"/>	6-165
5	Command 3-5	0.	FFFF.	0. (hex)		<input type="checkbox"/>	<input type="checkbox"/>	<input type="checkbox"/>	<input type="checkbox"/>	6-165
6	Command 3-6	0.	FFFF.	0. (hex)		<input type="checkbox"/>	<input type="checkbox"/>	<input type="checkbox"/>	<input type="checkbox"/>	6-165
7	Command 3-7	0.	FFFF.	0. (hex)		<input type="checkbox"/>	<input type="checkbox"/>	<input type="checkbox"/>	<input type="checkbox"/>	6-165
U44 – Built-in PLC command bank C										
0	Command 4-0	0.	FFFF.	0. (hex)	Set the built-in PLC command. The commands are executed in order from smallest number.	<input type="checkbox"/>	<input type="checkbox"/>	<input type="checkbox"/>	<input type="checkbox"/>	6-165
1	Command 4-1	0.	FFFF.	0. (hex)	This is valid when U10-0 is 3 or more.	<input type="checkbox"/>	<input type="checkbox"/>	<input type="checkbox"/>	<input type="checkbox"/>	6-165
2	Command 4-2	0.	FFFF.	0. (hex)		<input type="checkbox"/>	<input type="checkbox"/>	<input type="checkbox"/>	<input type="checkbox"/>	6-165
3	Command 4-3	0.	FFFF.	0. (hex)		<input type="checkbox"/>	<input type="checkbox"/>	<input type="checkbox"/>	<input type="checkbox"/>	6-165
4	Command 4-4	0.	FFFF.	0. (hex)		<input type="checkbox"/>	<input type="checkbox"/>	<input type="checkbox"/>	<input type="checkbox"/>	6-165
5	Command 4-5	0.	FFFF.	0. (hex)		<input type="checkbox"/>	<input type="checkbox"/>	<input type="checkbox"/>	<input type="checkbox"/>	6-165
6	Command 4-6	0.	FFFF.	0. (hex)		<input type="checkbox"/>	<input type="checkbox"/>	<input type="checkbox"/>	<input type="checkbox"/>	6-165
7	Command 4-7	0.	FFFF.	0. (hex)		<input type="checkbox"/>	<input type="checkbox"/>	<input type="checkbox"/>	<input type="checkbox"/>	6-165
U45 – Built-in PLC command bank C										
0	Command 5-0	0.	FFFF.	0. (hex)	Set the user parameters which can be used by the built-in PLC.	<input type="checkbox"/>	<input type="checkbox"/>	<input type="checkbox"/>	<input type="checkbox"/>	6-165
1	Command 5-1	0.	FFFF.	0. (hex)		<input type="checkbox"/>	<input type="checkbox"/>	<input type="checkbox"/>	<input type="checkbox"/>	6-165
2	Command 5-2	0.	FFFF.	0. (hex)		<input type="checkbox"/>	<input type="checkbox"/>	<input type="checkbox"/>	<input type="checkbox"/>	6-165
3	Command 5-3	0.	FFFF.	0. (hex)		<input type="checkbox"/>	<input type="checkbox"/>	<input type="checkbox"/>	<input type="checkbox"/>	6-165
4	Command 5-4	0.	FFFF.	0. (hex)		<input type="checkbox"/>	<input type="checkbox"/>	<input type="checkbox"/>	<input type="checkbox"/>	6-165
5	Command 5-5	0.	FFFF.	0. (hex)		<input type="checkbox"/>	<input type="checkbox"/>	<input type="checkbox"/>	<input type="checkbox"/>	6-165
6	Command 5-6	0.	FFFF.	0. (hex)		<input type="checkbox"/>	<input type="checkbox"/>	<input type="checkbox"/>	<input type="checkbox"/>	6-165
7	Command 5-7	0.	FFFF.	0. (hex)		<input type="checkbox"/>	<input type="checkbox"/>	<input type="checkbox"/>	<input type="checkbox"/>	6-165

6. Control Functions and Parameter Settings

Block-U parameter built-in PLC function settings

No.	Parameter	Min.	Max.	Default (Unit)	Function	Application				Ref. page
						Vf	VEC	PM	RWE	
U46 – Built-in PLC command bank C										
0	Command 6-0	0.	FFFF.	0. (hex)	Set the built-in PLC command. The commands are executed in order from smallest number.	<input type="checkbox"/>	<input type="checkbox"/>	<input type="checkbox"/>	<input type="checkbox"/>	6-165
1	Command 6-1	0.	FFFF.	0. (hex)	This is valid when U10-0 is 3 or more.	<input type="checkbox"/>	<input type="checkbox"/>	<input type="checkbox"/>	<input type="checkbox"/>	6-165
2	Command 6-2	0.	FFFF.	0. (hex)		<input type="checkbox"/>	<input type="checkbox"/>	<input type="checkbox"/>	<input type="checkbox"/>	6-165
3	Command 6-3	0.	FFFF.	0. (hex)		<input type="checkbox"/>	<input type="checkbox"/>	<input type="checkbox"/>	<input type="checkbox"/>	6-165
4	Command 6-4	0.	FFFF.	0. (hex)		<input type="checkbox"/>	<input type="checkbox"/>	<input type="checkbox"/>	<input type="checkbox"/>	6-165
5	Command 6-5	0.	FFFF.	0. (hex)		<input type="checkbox"/>	<input type="checkbox"/>	<input type="checkbox"/>	<input type="checkbox"/>	6-165
6	Command 6-6	0.	FFFF.	0. (hex)		<input type="checkbox"/>	<input type="checkbox"/>	<input type="checkbox"/>	<input type="checkbox"/>	6-165
7	Command 6-7	0.	FFFF.	0. (hex)		<input type="checkbox"/>	<input type="checkbox"/>	<input type="checkbox"/>	<input type="checkbox"/>	6-165
U47 – Built-in PLC command bank C										
0	Command 7-0	0.	FFFF.	0. (hex)	Set the built-in PLC command. The commands are executed in order from smallest number.	<input type="checkbox"/>	<input type="checkbox"/>	<input type="checkbox"/>	<input type="checkbox"/>	6-165
1	Command 7-1	0.	FFFF.	0. (hex)	This is valid when U10-0 is 3 or more.	<input type="checkbox"/>	<input type="checkbox"/>	<input type="checkbox"/>	<input type="checkbox"/>	6-165
2	Command 7-2	0.	FFFF.	0. (hex)		<input type="checkbox"/>	<input type="checkbox"/>	<input type="checkbox"/>	<input type="checkbox"/>	6-165
3	Command 7-3	0.	FFFF.	0. (hex)		<input type="checkbox"/>	<input type="checkbox"/>	<input type="checkbox"/>	<input type="checkbox"/>	6-165
4	Command 7-4	0.	FFFF.	0. (hex)		<input type="checkbox"/>	<input type="checkbox"/>	<input type="checkbox"/>	<input type="checkbox"/>	6-165
5	Command 7-5	0.	FFFF.	0. (hex)		<input type="checkbox"/>	<input type="checkbox"/>	<input type="checkbox"/>	<input type="checkbox"/>	6-165
6	Command 7-6	0.	FFFF.	0. (hex)		<input type="checkbox"/>	<input type="checkbox"/>	<input type="checkbox"/>	<input type="checkbox"/>	6-165
7	Command 7-7	0.	FFFF.	0. (hex)		<input type="checkbox"/>	<input type="checkbox"/>	<input type="checkbox"/>	<input type="checkbox"/>	6-165

6. Control Functions and Parameter Settings

Block-U parameter built-in PLC function settings

No.	Parameter	Min.	Max.	Default (Unit)	Function	Application				Ref. page
						Vf	VEC	PM	RWE	
U50 – Built-in PLC command bank D										
0	Command 0-0	0.	FFFF.	0. (hex)	Set the built-in PLC command. The commands are executed in order from smallest number.	<input type="checkbox"/>	<input type="checkbox"/>	<input type="checkbox"/>	<input type="checkbox"/>	6-165
1	Command 0-1	0.	FFFF.	0. (hex)	This is valid when U10-0 is 4 or more.	<input type="checkbox"/>	<input type="checkbox"/>	<input type="checkbox"/>	<input type="checkbox"/>	6-165
2	Command 0-2	0.	FFFF.	0. (hex)		<input type="checkbox"/>	<input type="checkbox"/>	<input type="checkbox"/>	<input type="checkbox"/>	6-165
3	Command 0-3	0.	FFFF.	0. (hex)		<input type="checkbox"/>	<input type="checkbox"/>	<input type="checkbox"/>	<input type="checkbox"/>	6-165
4	Command 0-4	0.	FFFF.	0. (hex)		<input type="checkbox"/>	<input type="checkbox"/>	<input type="checkbox"/>	<input type="checkbox"/>	6-165
5	Command 0-5	0.	FFFF.	0. (hex)		<input type="checkbox"/>	<input type="checkbox"/>	<input type="checkbox"/>	<input type="checkbox"/>	6-165
6	Command 0-6	0.	FFFF.	0. (hex)		<input type="checkbox"/>	<input type="checkbox"/>	<input type="checkbox"/>	<input type="checkbox"/>	6-165
7	Command 0-7	0.	FFFF.	0. (hex)		<input type="checkbox"/>	<input type="checkbox"/>	<input type="checkbox"/>	<input type="checkbox"/>	6-165
U51 – Built-in PLC command bank D										
0	Command 1-0	0.	FFFF.	0. (hex)	Set the built-in PLC command. The commands are executed in order from smallest number.	<input type="checkbox"/>	<input type="checkbox"/>	<input type="checkbox"/>	<input type="checkbox"/>	6-165
1	Command 1-1	0.	FFFF.	0. (hex)	This is valid when U10-0 is 4 or more.	<input type="checkbox"/>	<input type="checkbox"/>	<input type="checkbox"/>	<input type="checkbox"/>	6-165
2	Command 1-2	0.	FFFF.	0. (hex)		<input type="checkbox"/>	<input type="checkbox"/>	<input type="checkbox"/>	<input type="checkbox"/>	6-165
3	Command 1-3	0.	FFFF.	0. (hex)		<input type="checkbox"/>	<input type="checkbox"/>	<input type="checkbox"/>	<input type="checkbox"/>	6-165
4	Command 1-4	0.	FFFF.	0. (hex)		<input type="checkbox"/>	<input type="checkbox"/>	<input type="checkbox"/>	<input type="checkbox"/>	6-165
5	Command 1-5	0.	FFFF.	0. (hex)		<input type="checkbox"/>	<input type="checkbox"/>	<input type="checkbox"/>	<input type="checkbox"/>	6-165
6	Command 1-6	0.	FFFF.	0. (hex)		<input type="checkbox"/>	<input type="checkbox"/>	<input type="checkbox"/>	<input type="checkbox"/>	6-165
7	Command 1-7	0.	FFFF.	0. (hex)		<input type="checkbox"/>	<input type="checkbox"/>	<input type="checkbox"/>	<input type="checkbox"/>	6-165
U52 – Built-in PLC command bank D										
0	Command 2-0	0.	FFFF.	0. (hex)	Set the user parameters which can be used by the built-in PLC.	<input type="checkbox"/>	<input type="checkbox"/>	<input type="checkbox"/>	<input type="checkbox"/>	6-165
1	Command 2-1	0.	FFFF.	0. (hex)		<input type="checkbox"/>	<input type="checkbox"/>	<input type="checkbox"/>	<input type="checkbox"/>	6-165
2	Command 2-2	0.	FFFF.	0. (hex)		<input type="checkbox"/>	<input type="checkbox"/>	<input type="checkbox"/>	<input type="checkbox"/>	6-165
3	Command 2-3	0.	FFFF.	0. (hex)		<input type="checkbox"/>	<input type="checkbox"/>	<input type="checkbox"/>	<input type="checkbox"/>	6-165
4	Command 2-4	0.	FFFF.	0. (hex)		<input type="checkbox"/>	<input type="checkbox"/>	<input type="checkbox"/>	<input type="checkbox"/>	6-165
5	Command 2-5	0.	FFFF.	0. (hex)		<input type="checkbox"/>	<input type="checkbox"/>	<input type="checkbox"/>	<input type="checkbox"/>	6-165
6	Command 2-6	0.	FFFF.	0. (hex)		<input type="checkbox"/>	<input type="checkbox"/>	<input type="checkbox"/>	<input type="checkbox"/>	6-165
7	Command 2-7	0.	FFFF.	0. (hex)		<input type="checkbox"/>	<input type="checkbox"/>	<input type="checkbox"/>	<input type="checkbox"/>	6-165

6. Control Functions and Parameter Settings

Block-U parameter built-in PLC function settings

No.	Parameter	Min.	Max.	Default (Unit)	Function	Application				Ref. page
						Vf	VEC	PM	RWE	
U53 – Built-in PLC command bank D										
0	Command 3-0	0.	FFFF.	0. (hex)	Set the built-in PLC command. The commands are executed in order from smallest number.	<input type="checkbox"/>	<input type="checkbox"/>	<input type="checkbox"/>	<input type="checkbox"/>	6-165
1	Command 3-1	0.	FFFF.	0. (hex)	This is valid when U10-0 is 4 or more.	<input type="checkbox"/>	<input type="checkbox"/>	<input type="checkbox"/>	<input type="checkbox"/>	6-165
2	Command 3-2	0.	FFFF.	0. (hex)		<input type="checkbox"/>	<input type="checkbox"/>	<input type="checkbox"/>	<input type="checkbox"/>	6-165
3	Command 3-3	0.	FFFF.	0. (hex)		<input type="checkbox"/>	<input type="checkbox"/>	<input type="checkbox"/>	<input type="checkbox"/>	6-165
4	Command 3-4	0.	FFFF.	0. (hex)		<input type="checkbox"/>	<input type="checkbox"/>	<input type="checkbox"/>	<input type="checkbox"/>	6-165
5	Command 3-5	0.	FFFF.	0. (hex)		<input type="checkbox"/>	<input type="checkbox"/>	<input type="checkbox"/>	<input type="checkbox"/>	6-165
6	Command 3-6	0.	FFFF.	0. (hex)		<input type="checkbox"/>	<input type="checkbox"/>	<input type="checkbox"/>	<input type="checkbox"/>	6-165
7	Command 3-7	0.	FFFF.	0. (hex)		<input type="checkbox"/>	<input type="checkbox"/>	<input type="checkbox"/>	<input type="checkbox"/>	6-165
U54 – Built-in PLC command bank D										
0	Command 4-0	0.	FFFF.	0. (hex)	Set the built-in PLC command. The commands are executed in order from smallest number.	<input type="checkbox"/>	<input type="checkbox"/>	<input type="checkbox"/>	<input type="checkbox"/>	6-165
1	Command 4-1	0.	FFFF.	0. (hex)	This is valid when U10-0 is 4 or more.	<input type="checkbox"/>	<input type="checkbox"/>	<input type="checkbox"/>	<input type="checkbox"/>	6-165
2	Command 4-2	0.	FFFF.	0. (hex)		<input type="checkbox"/>	<input type="checkbox"/>	<input type="checkbox"/>	<input type="checkbox"/>	6-165
3	Command 4-3	0.	FFFF.	0. (hex)		<input type="checkbox"/>	<input type="checkbox"/>	<input type="checkbox"/>	<input type="checkbox"/>	6-165
4	Command 4-4	0.	FFFF.	0. (hex)		<input type="checkbox"/>	<input type="checkbox"/>	<input type="checkbox"/>	<input type="checkbox"/>	6-165
5	Command 4-5	0.	FFFF.	0. (hex)		<input type="checkbox"/>	<input type="checkbox"/>	<input type="checkbox"/>	<input type="checkbox"/>	6-165
6	Command 4-6	0.	FFFF.	0. (hex)		<input type="checkbox"/>	<input type="checkbox"/>	<input type="checkbox"/>	<input type="checkbox"/>	6-165
7	Command 4-7	0.	FFFF.	0. (hex)		<input type="checkbox"/>	<input type="checkbox"/>	<input type="checkbox"/>	<input type="checkbox"/>	6-165
U55 – Built-in PLC command bank D										
0	Command 5-0	0.	FFFF.	0. (hex)	Set the user parameters which can be used by the built-in PLC.	<input type="checkbox"/>	<input type="checkbox"/>	<input type="checkbox"/>	<input type="checkbox"/>	6-165
1	Command 5-1	0.	FFFF.	0. (hex)		<input type="checkbox"/>	<input type="checkbox"/>	<input type="checkbox"/>	<input type="checkbox"/>	6-165
2	Command 5-2	0.	FFFF.	0. (hex)		<input type="checkbox"/>	<input type="checkbox"/>	<input type="checkbox"/>	<input type="checkbox"/>	6-165
3	Command 5-3	0.	FFFF.	0. (hex)		<input type="checkbox"/>	<input type="checkbox"/>	<input type="checkbox"/>	<input type="checkbox"/>	6-165
4	Command 5-4	0.	FFFF.	0. (hex)		<input type="checkbox"/>	<input type="checkbox"/>	<input type="checkbox"/>	<input type="checkbox"/>	6-165
5	Command 5-5	0.	FFFF.	0. (hex)		<input type="checkbox"/>	<input type="checkbox"/>	<input type="checkbox"/>	<input type="checkbox"/>	6-165
6	Command 5-6	0.	FFFF.	0. (hex)		<input type="checkbox"/>	<input type="checkbox"/>	<input type="checkbox"/>	<input type="checkbox"/>	6-165
7	Command 5-7	0.	FFFF.	0. (hex)		<input type="checkbox"/>	<input type="checkbox"/>	<input type="checkbox"/>	<input type="checkbox"/>	6-165

6. Control Functions and Parameter Settings

Block-U parameter built-in PLC function settings

No.	Parameter	Min.	Max.	Default (Unit)	Function	Application				Ref. page
						Vf	VEC	PM	RWE	
U56 – Built-in PLC command bank D										
0	Command 6-0	0.	FFFF.	0. (hex)	Set the built-in PLC command. The commands are executed in order from smallest number.	<input type="checkbox"/>	<input type="checkbox"/>	<input type="checkbox"/>	<input type="checkbox"/>	6-165
1	Command 6-1	0.	FFFF.	0. (hex)	This is valid when U10-0 is 4 or more.	<input type="checkbox"/>	<input type="checkbox"/>	<input type="checkbox"/>	<input type="checkbox"/>	6-165
2	Command 6-2	0.	FFFF.	0. (hex)		<input type="checkbox"/>	<input type="checkbox"/>	<input type="checkbox"/>	<input type="checkbox"/>	6-165
3	Command 6-3	0.	FFFF.	0. (hex)		<input type="checkbox"/>	<input type="checkbox"/>	<input type="checkbox"/>	<input type="checkbox"/>	6-165
4	Command 6-4	0.	FFFF.	0. (hex)		<input type="checkbox"/>	<input type="checkbox"/>	<input type="checkbox"/>	<input type="checkbox"/>	6-165
5	Command 6-5	0.	FFFF.	0. (hex)		<input type="checkbox"/>	<input type="checkbox"/>	<input type="checkbox"/>	<input type="checkbox"/>	6-165
6	Command 6-6	0.	FFFF.	0. (hex)		<input type="checkbox"/>	<input type="checkbox"/>	<input type="checkbox"/>	<input type="checkbox"/>	6-165
7	Command 6-7	0.	FFFF.	0. (hex)		<input type="checkbox"/>	<input type="checkbox"/>	<input type="checkbox"/>	<input type="checkbox"/>	6-165
U57 – Built-in PLC command bank D										
0	Command 7-0	0.	FFFF.	0. (hex)	Set the built-in PLC command. The commands are executed in order from smallest number.	<input type="checkbox"/>	<input type="checkbox"/>	<input type="checkbox"/>	<input type="checkbox"/>	6-165
1	Command 7-1	0.	FFFF.	0. (hex)	This is valid when U10-0 is 4 or more.	<input type="checkbox"/>	<input type="checkbox"/>	<input type="checkbox"/>	<input type="checkbox"/>	6-165
2	Command 7-2	0.	FFFF.	0. (hex)		<input type="checkbox"/>	<input type="checkbox"/>	<input type="checkbox"/>	<input type="checkbox"/>	6-165
3	Command 7-3	0.	FFFF.	0. (hex)		<input type="checkbox"/>	<input type="checkbox"/>	<input type="checkbox"/>	<input type="checkbox"/>	6-165
4	Command 7-4	0.	FFFF.	0. (hex)		<input type="checkbox"/>	<input type="checkbox"/>	<input type="checkbox"/>	<input type="checkbox"/>	6-165
5	Command 7-5	0.	FFFF.	0. (hex)		<input type="checkbox"/>	<input type="checkbox"/>	<input type="checkbox"/>	<input type="checkbox"/>	6-165
6	Command 7-6	0.	FFFF.	0. (hex)		<input type="checkbox"/>	<input type="checkbox"/>	<input type="checkbox"/>	<input type="checkbox"/>	6-165
7	Command 7-7	0.	FFFF.	0. (hex)		<input type="checkbox"/>	<input type="checkbox"/>	<input type="checkbox"/>	<input type="checkbox"/>	6-165

6. Control Functions and Parameter Settings

Block-U parameter built-in PLC function settings

No.	Parameter	Min.	Max.	Default (Unit)	Function	Application				Ref. page
						Vf	VEC	PM	RWE	
U60 – Built-in PLC command bank E										
0	Command 0-0	0.	FFFF.	0. (hex)	Set the built-in PLC command. The commands are executed in order from smallest number.	<input type="checkbox"/>	<input type="checkbox"/>	<input type="checkbox"/>	<input type="checkbox"/>	6-166
1	Command 0-1	0.	FFFF.	0. (hex)	This is valid when U10-0 is 5 or more.	<input type="checkbox"/>	<input type="checkbox"/>	<input type="checkbox"/>	<input type="checkbox"/>	6-166
2	Command 0-2	0.	FFFF.	0. (hex)		<input type="checkbox"/>	<input type="checkbox"/>	<input type="checkbox"/>	<input type="checkbox"/>	6-166
3	Command 0-3	0.	FFFF.	0. (hex)		<input type="checkbox"/>	<input type="checkbox"/>	<input type="checkbox"/>	<input type="checkbox"/>	6-166
4	Command 0-4	0.	FFFF.	0. (hex)		<input type="checkbox"/>	<input type="checkbox"/>	<input type="checkbox"/>	<input type="checkbox"/>	6-166
5	Command 0-5	0.	FFFF.	0. (hex)		<input type="checkbox"/>	<input type="checkbox"/>	<input type="checkbox"/>	<input type="checkbox"/>	6-166
6	Command 0-6	0.	FFFF.	0. (hex)		<input type="checkbox"/>	<input type="checkbox"/>	<input type="checkbox"/>	<input type="checkbox"/>	6-166
7	Command 0-7	0.	FFFF.	0. (hex)		<input type="checkbox"/>	<input type="checkbox"/>	<input type="checkbox"/>	<input type="checkbox"/>	6-166
U61 – Built-in PLC command bank E										
0	Command 1-0	0.	FFFF.	0. (hex)	Set the built-in PLC command. The commands are executed in order from smallest number.	<input type="checkbox"/>	<input type="checkbox"/>	<input type="checkbox"/>	<input type="checkbox"/>	6-166
1	Command 1-1	0.	FFFF.	0. (hex)	This is valid when U10-0 is 5 or more.	<input type="checkbox"/>	<input type="checkbox"/>	<input type="checkbox"/>	<input type="checkbox"/>	6-166
2	Command 1-2	0.	FFFF.	0. (hex)		<input type="checkbox"/>	<input type="checkbox"/>	<input type="checkbox"/>	<input type="checkbox"/>	6-166
3	Command 1-3	0.	FFFF.	0. (hex)		<input type="checkbox"/>	<input type="checkbox"/>	<input type="checkbox"/>	<input type="checkbox"/>	6-166
4	Command 1-4	0.	FFFF.	0. (hex)		<input type="checkbox"/>	<input type="checkbox"/>	<input type="checkbox"/>	<input type="checkbox"/>	6-166
5	Command 1-5	0.	FFFF.	0. (hex)		<input type="checkbox"/>	<input type="checkbox"/>	<input type="checkbox"/>	<input type="checkbox"/>	6-166
6	Command 1-6	0.	FFFF.	0. (hex)		<input type="checkbox"/>	<input type="checkbox"/>	<input type="checkbox"/>	<input type="checkbox"/>	6-166
7	Command 1-7	0.	FFFF.	0. (hex)		<input type="checkbox"/>	<input type="checkbox"/>	<input type="checkbox"/>	<input type="checkbox"/>	6-166
U62 – Built-in PLC command bank E										
0	Command 2-0	0.	FFFF.	0. (hex)	Set the user parameters which can be used by the built-in PLC.	<input type="checkbox"/>	<input type="checkbox"/>	<input type="checkbox"/>	<input type="checkbox"/>	6-166
1	Command 2-1	0.	FFFF.	0. (hex)		<input type="checkbox"/>	<input type="checkbox"/>	<input type="checkbox"/>	<input type="checkbox"/>	6-166
2	Command 2-2	0.	FFFF.	0. (hex)		<input type="checkbox"/>	<input type="checkbox"/>	<input type="checkbox"/>	<input type="checkbox"/>	6-166
3	Command 2-3	0.	FFFF.	0. (hex)		<input type="checkbox"/>	<input type="checkbox"/>	<input type="checkbox"/>	<input type="checkbox"/>	6-166
4	Command 2-4	0.	FFFF.	0. (hex)		<input type="checkbox"/>	<input type="checkbox"/>	<input type="checkbox"/>	<input type="checkbox"/>	6-166
5	Command 2-5	0.	FFFF.	0. (hex)		<input type="checkbox"/>	<input type="checkbox"/>	<input type="checkbox"/>	<input type="checkbox"/>	6-166
6	Command 2-6	0.	FFFF.	0. (hex)		<input type="checkbox"/>	<input type="checkbox"/>	<input type="checkbox"/>	<input type="checkbox"/>	6-166
7	Command 2-7	0.	FFFF.	0. (hex)		<input type="checkbox"/>	<input type="checkbox"/>	<input type="checkbox"/>	<input type="checkbox"/>	6-166

6. Control Functions and Parameter Settings

Block-U parameter built-in PLC function settings

No.	Parameter	Min.	Max.	Default (Unit)	Function	Application				Ref. page
						Vf	VEC	PM	RWE	
U63 – Built-in PLC command bank E										
0	Command 3-0	0.	FFFF.	0. (hex)	Set the built-in PLC command. The commands are executed in order from smallest number.	<input type="checkbox"/>	<input type="checkbox"/>	<input type="checkbox"/>	<input type="checkbox"/>	6-166
1	Command 3-1	0.	FFFF.	0. (hex)	This is valid when U10-0 is 5 or more.	<input type="checkbox"/>	<input type="checkbox"/>	<input type="checkbox"/>	<input type="checkbox"/>	6-166
2	Command 3-2	0.	FFFF.	0. (hex)		<input type="checkbox"/>	<input type="checkbox"/>	<input type="checkbox"/>	<input type="checkbox"/>	6-166
3	Command 3-3	0.	FFFF.	0. (hex)		<input type="checkbox"/>	<input type="checkbox"/>	<input type="checkbox"/>	<input type="checkbox"/>	6-166
4	Command 3-4	0.	FFFF.	0. (hex)		<input type="checkbox"/>	<input type="checkbox"/>	<input type="checkbox"/>	<input type="checkbox"/>	6-166
5	Command 3-5	0.	FFFF.	0. (hex)		<input type="checkbox"/>	<input type="checkbox"/>	<input type="checkbox"/>	<input type="checkbox"/>	6-166
6	Command 3-6	0.	FFFF.	0. (hex)		<input type="checkbox"/>	<input type="checkbox"/>	<input type="checkbox"/>	<input type="checkbox"/>	6-166
7	Command 3-7	0.	FFFF.	0. (hex)		<input type="checkbox"/>	<input type="checkbox"/>	<input type="checkbox"/>	<input type="checkbox"/>	6-166
U64 – Built-in PLC command bank E										
0	Command 4-0	0.	FFFF.	0. (hex)	Set the built-in PLC command. The commands are executed in order from smallest number.	<input type="checkbox"/>	<input type="checkbox"/>	<input type="checkbox"/>	<input type="checkbox"/>	6-166
1	Command 4-1	0.	FFFF.	0. (hex)	This is valid when U10-0 is 5 or more.	<input type="checkbox"/>	<input type="checkbox"/>	<input type="checkbox"/>	<input type="checkbox"/>	6-166
2	Command 4-2	0.	FFFF.	0. (hex)		<input type="checkbox"/>	<input type="checkbox"/>	<input type="checkbox"/>	<input type="checkbox"/>	6-166
3	Command 4-3	0.	FFFF.	0. (hex)		<input type="checkbox"/>	<input type="checkbox"/>	<input type="checkbox"/>	<input type="checkbox"/>	6-166
4	Command 4-4	0.	FFFF.	0. (hex)		<input type="checkbox"/>	<input type="checkbox"/>	<input type="checkbox"/>	<input type="checkbox"/>	6-166
5	Command 4-5	0.	FFFF.	0. (hex)		<input type="checkbox"/>	<input type="checkbox"/>	<input type="checkbox"/>	<input type="checkbox"/>	6-166
6	Command 4-6	0.	FFFF.	0. (hex)		<input type="checkbox"/>	<input type="checkbox"/>	<input type="checkbox"/>	<input type="checkbox"/>	6-166
7	Command 4-7	0.	FFFF.	0. (hex)		<input type="checkbox"/>	<input type="checkbox"/>	<input type="checkbox"/>	<input type="checkbox"/>	6-166
U65 – Built-in PLC command bank E										
0	Command 5-0	0.	FFFF.	0. (hex)	Set the user parameters which can be used by the built-in PLC.	<input type="checkbox"/>	<input type="checkbox"/>	<input type="checkbox"/>	<input type="checkbox"/>	6-166
1	Command 5-1	0.	FFFF.	0. (hex)		<input type="checkbox"/>	<input type="checkbox"/>	<input type="checkbox"/>	<input type="checkbox"/>	6-166
2	Command 5-2	0.	FFFF.	0. (hex)		<input type="checkbox"/>	<input type="checkbox"/>	<input type="checkbox"/>	<input type="checkbox"/>	6-166
3	Command 5-3	0.	FFFF.	0. (hex)		<input type="checkbox"/>	<input type="checkbox"/>	<input type="checkbox"/>	<input type="checkbox"/>	6-166
4	Command 5-4	0.	FFFF.	0. (hex)		<input type="checkbox"/>	<input type="checkbox"/>	<input type="checkbox"/>	<input type="checkbox"/>	6-166
5	Command 5-5	0.	FFFF.	0. (hex)		<input type="checkbox"/>	<input type="checkbox"/>	<input type="checkbox"/>	<input type="checkbox"/>	6-166
6	Command 5-6	0.	FFFF.	0. (hex)		<input type="checkbox"/>	<input type="checkbox"/>	<input type="checkbox"/>	<input type="checkbox"/>	6-166
7	Command 5-7	0.	FFFF.	0. (hex)		<input type="checkbox"/>	<input type="checkbox"/>	<input type="checkbox"/>	<input type="checkbox"/>	6-166

6. Control Functions and Parameter Settings

Block-U parameter built-in PLC function settings

No.	Parameter	Min.	Max.	Default (Unit)	Function	Application				Ref. page
						Vf	VEC	PM	RWE	
U66 – Built-in PLC command bank E										
0	Command 6-0	0.	FFFF.	0. (hex)	Set the built-in PLC command. The commands are executed in order from smallest number.	<input type="checkbox"/>	<input type="checkbox"/>	<input type="checkbox"/>	<input type="checkbox"/>	6-166
1	Command 6-1	0.	FFFF.	0. (hex)	This is valid when U10-0 is 5 or more.	<input type="checkbox"/>	<input type="checkbox"/>	<input type="checkbox"/>	<input type="checkbox"/>	6-166
2	Command 6-2	0.	FFFF.	0. (hex)		<input type="checkbox"/>	<input type="checkbox"/>	<input type="checkbox"/>	<input type="checkbox"/>	6-166
3	Command 6-3	0.	FFFF.	0. (hex)		<input type="checkbox"/>	<input type="checkbox"/>	<input type="checkbox"/>	<input type="checkbox"/>	6-166
4	Command 6-4	0.	FFFF.	0. (hex)		<input type="checkbox"/>	<input type="checkbox"/>	<input type="checkbox"/>	<input type="checkbox"/>	6-166
5	Command 6-5	0.	FFFF.	0. (hex)		<input type="checkbox"/>	<input type="checkbox"/>	<input type="checkbox"/>	<input type="checkbox"/>	6-166
6	Command 6-6	0.	FFFF.	0. (hex)		<input type="checkbox"/>	<input type="checkbox"/>	<input type="checkbox"/>	<input type="checkbox"/>	6-166
7	Command 6-7	0.	FFFF.	0. (hex)		<input type="checkbox"/>	<input type="checkbox"/>	<input type="checkbox"/>	<input type="checkbox"/>	6-166
U67 – Built-in PLC command bank E										
0	Command 7-0	0.	FFFF.	0. (hex)	Set the built-in PLC command. The commands are executed in order from smallest number.	<input type="checkbox"/>	<input type="checkbox"/>	<input type="checkbox"/>	<input type="checkbox"/>	6-166
1	Command 7-1	0.	FFFF.	0. (hex)	This is valid when U10-0 is 5 or more.	<input type="checkbox"/>	<input type="checkbox"/>	<input type="checkbox"/>	<input type="checkbox"/>	6-166
2	Command 7-2	0.	FFFF.	0. (hex)		<input type="checkbox"/>	<input type="checkbox"/>	<input type="checkbox"/>	<input type="checkbox"/>	6-166
3	Command 7-3	0.	FFFF.	0. (hex)		<input type="checkbox"/>	<input type="checkbox"/>	<input type="checkbox"/>	<input type="checkbox"/>	6-166
4	Command 7-4	0.	FFFF.	0. (hex)		<input type="checkbox"/>	<input type="checkbox"/>	<input type="checkbox"/>	<input type="checkbox"/>	6-166
5	Command 7-5	0.	FFFF.	0. (hex)		<input type="checkbox"/>	<input type="checkbox"/>	<input type="checkbox"/>	<input type="checkbox"/>	6-166
6	Command 7-6	0.	FFFF.	0. (hex)		<input type="checkbox"/>	<input type="checkbox"/>	<input type="checkbox"/>	<input type="checkbox"/>	6-166
7	Command 7-7	0.	FFFF.	0. (hex)		<input type="checkbox"/>	<input type="checkbox"/>	<input type="checkbox"/>	<input type="checkbox"/>	6-166

6-6 Function explanation

6-6-1 Explanation of monitor parameters (Block-D parameter) functions

D00-0
D00-1

Output frequency in Hz

Output frequency in %

This indicates the frequency currently being output.
 With D00-1, the maximum frequency is indicated as 100%.
 ̄̄̄̄̄ will display when the gate is closed.
 ̄̄̄̄̄ displays while the DC brake is in action.
 ̄̄̄̄̄ is displayed during pick-up.

D00-2
D00-3

Motor speed in min⁻¹

Motor speed in %

This indicates the current motor speed.
 (This is displayed even when operation is stopped.)
 With D00-3, the maximum speed is indicated as 100%.
 The motor forward run is indicated with a positive polarity, and reverse run is indicated with a negative polarity.

D00-4

Output frequency/motor speed random scale display

The result of the C14-2 random scale display coefficient multiplied by the D00-0: output frequency is displayed for V/f control operation or auxiliary drive operation, and the random scale display coefficient multiplied by the D00-2: motor speed is displayed for IM vector control and PM motor control.
 If the value exceeds the range of -99999 to 99999, "OVER." will be displayed.

D00-5

Motor rotation count in %

The motor speed detected with the speed detection option is displayed as a percentage in respect to the maximum speed.
 If the speed detection option is provided, the motor speed is displayed even during V/f control or sensor-less vector control.

D01-0
D01-1

Set frequency in Hz

Set frequency in %

The currently selected frequency setting value is displayed
 With D01-1, the maximum frequency is displayed as 100%.

D01-2

Ramp function output speed in min⁻¹

The set speed at ASR input point is displayed.
 The motor forward run is indicated with a positive polarity, and reverse run is indicated with a negative polarity.

D01-3

Ramp function input speed in min⁻¹

The set speed at the ramp function's input point is displayed.
 The motor forward run is indicated with a positive polarity, and reverse run is indicated with a negative polarity.

D01-4

Set frequency/input speed Random scale display

The result of the C14-2 random scale display coefficient multiplied by the D01-0: set frequency is displayed for V/f control operation or auxiliary drive operation, and the random scale display coefficient multiplied by the D01-3: ramp function input speed is displayed for IM vector control and PM motor control.

If the value exceeds the range of -99999 to 99999, "OVER." will be displayed.

D02-0

Output current in Amps

D02-1

Output current in %

The output current is displayed. With D02-1, the motor rated current is displayed as 100%.
OFF will display when the gate is closed.

D02-2

Overload (OL-1) monitor

If the output current exceeds the unit's rated current, the display value counts up from 0%.
In the normal-duty mode (Normal-duty, C30-0 $\overline{f1}$ = 1), the display counts up at rate of 120%/minute in respect to the unit's rated current. In the heavy-duty mode (Heavy-duty, C30-0 $\overline{f1}$ = 2), the display counts up at a rate of 150%/minute.

When this display value reaches 100%, a fault "OL-1" (unit overload) occurs.

(Note) The unit rated current value differs for the normal-duty mode and heavy-duty mode.
Check the levels in Appendix Table 1.

D02-3

Motor overload (OL-3) monitor

If the output current exceeds the motor overload reference set with C22-0 to C22-3, the display counts up from 0%.

When this display value reaches 100%, a fault "OL-3" (motor overload) occurs.

D02-4

Heatsink temperature in °C

The heat sink temperature is displayed.

If this temperature exceeds the fault judgment value, the fault "UOH.1" (overheat) will occur.
The fault judgment temperature is either 95°C or 120°C, depending on the capacity.

D02-5

Torque current detection in %

The output current detection value's torque current element is displayed using the motor rated current as 100%.

This is a negative polarity during regenerative torquing.

D02-6

Excitation current detection in %

During the IM vector control mode, the output current detection value's excitation current element is displayed using the motor rated current as 100%.

During the PM motor control mode, the output current detection value's weak magnetic field current element is displayed using the motor rated current as 100%. This is a negative polarity while the weak magnetic field current is passing.

- D02-7** **U phase output current in Amps**
- D02-8** **V phase output current in Amps**
- D02-9** **W phase output current in Amps**

The output current of each phase is displayed.
 ̳̳̳ will display when the gate is closed.
 The correct value is not displayed during pick-up or during automatic tuning.

- D03-0** **DC voltage in V**

The voltage value of the DC middle circuit in the inverter's main circuit is displayed.

- D03-1** **Output voltage (command) in V**

The output current command value is displayed. The display may differ from the actual output voltage. It depends on the power supply voltage. ̳̳̳ will display when the gate is closed.

- D03-2** **Output power in kW**

The output current command value is displayed. The display may differ from the actual output voltage. It depends on the power supply voltage. ̳̳̳ will display when the gate is closed.

- D03-3** **Carrier frequency in kHz**

The current carrier frequency is displayed.
 When the carrier frequency automatic reduction function is activating, the carrier frequency after reduction is displayed.

- D04-0~3** **Sequence status-Input**

The ON/OFF status of the input sequence data is displayed.
 Each segment of the LED and the signal correspond as shown below.

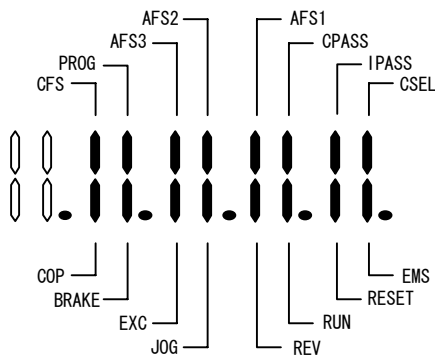

Sequence input (D04-0)

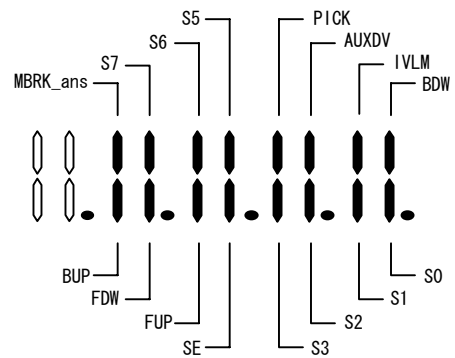

Sequence input (D04-1)

6. Control Functions and Parameter Settings

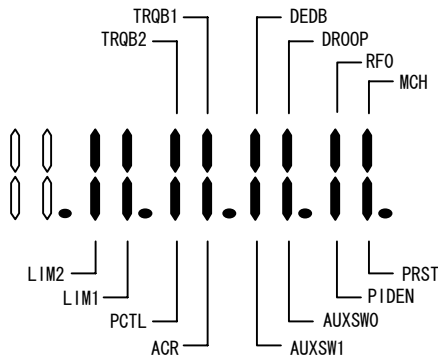

Sequence input (D04-2)

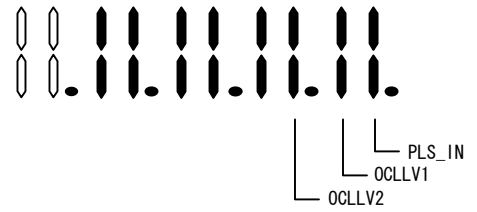

Sequence input (D04-3)

D04-4~7

Sequence status-Output

The ON/OFF status of the output sequence data is displayed. Each segment of the LED and the signal correspond as shown below.

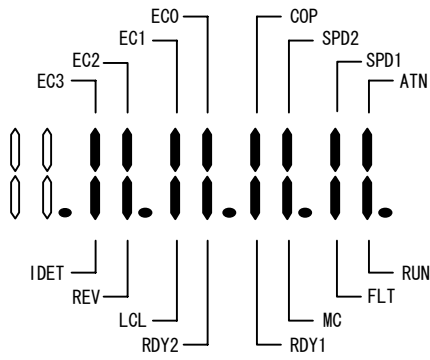

Sequence output (D04-4)

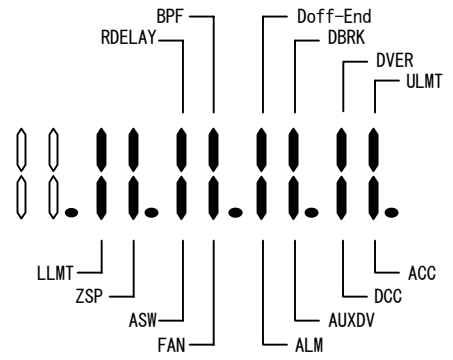

Sequence output (D04-5)

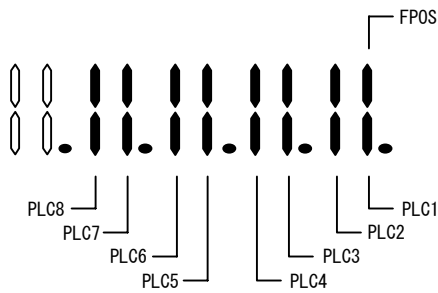

Sequence output (D04-6)

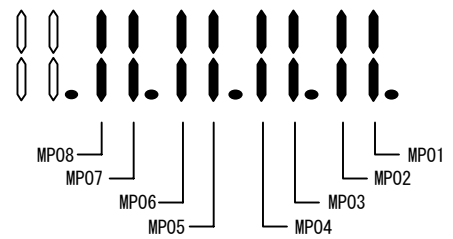

Sequence output (D04-7)

D05-0

Minor fault monitor

The ON/OFF status of the minor fault is displayed.
Each segment of the LED and the signal correspond as shown below.

D05-1

ASIC breakdown monitor

The ASIC fault status is displayed.
Each segment of the LED and the signal correspond as shown below.

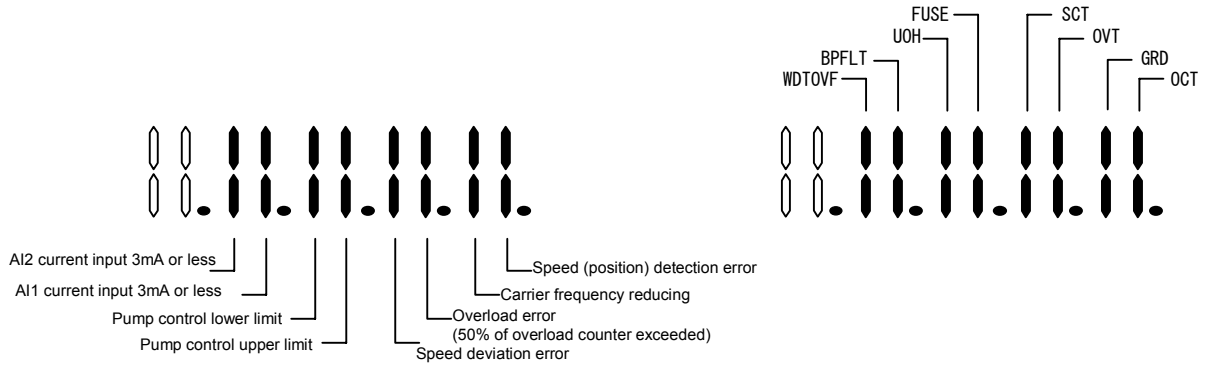

Minor fault (D05-0)

ASIC fault status (D05-1)

D06-0

Pattern run Step No. monitor

The current step No. will display.

D06-1

Pattern run Remaining time monitor in s

The remaining time of current step will display

D07-0

Pump operation status monitor

When using multi-pump control, the ON/OFF status of the pump is displayed.
Each segment of the LED and the signal correspond as shown below.

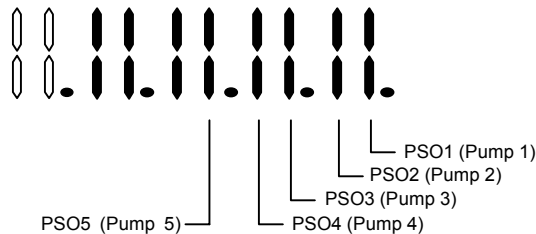

Pump operation status monitor (D07-0)

D07-1

Current inverter drive pump No. monitor

This displays the number of the pump currently driven by the inverter.

D07-2

Next ON pump No. monitor

0 is displayed when all pumps are ON.

D07-3

Next OFF pump No. monitor

0 is displayed when all pumps are OFF.

D07-4

Elapsed time in h

The time that the pump currently driven by the inverter has stayed ON continuously is displayed.

This is cleared when the pump operation changes over.

D08-0

Analog input random scale display/AI1

D08-1

Analog input random scale display/AI2

D08-2

Analog input random scale display/AI3

The result of the AI1, 2, 3 setting multiplied by the coefficient set in C14-5, 6, 7 is displayed. If the value exceeds the range of -99999 to 99999, "OVER." will be displayed.

D10-0

Built-in PLC display 1

D10-1

Built-in PLC display 2

D10-2

Built-in PLC display 3

D10-3

Built-in PLC display 4

The details of address 36 to 39 of the built-in PLC memory are displayed.

D11-0

Torque setting input monitor in %

The currently selected torque setting of the current control input points is selected.

This is displayed as a percentage in respect to the motor's rated torque.

D11-1

Analog torque setting monitor in %

The setting value input from the analog torque setting is displayed.

If the sequence input ACR is ON and the torque setting input point selection C02-2 is set to 1, the torque command value will be displayed here.

This is displayed as a percentage in respect to the motor's rated torque.

D11-2

Serial communication torque setting monitor in %

The setting value input from the serial communication torque setting is displayed.

If the sequence input ACR is ON and the torque setting input point selection C02-2 is set to 2, the torque command value will be displayed here.

This is displayed as a percentage in respect to the motor's rated torque.

D11-3

Operation panel torque setting monitor in %

The torque setting value (B13-0) input from the operation panel is displayed.

If the sequence input ACR is ON and the torque setting input point selection C02-2 is set to 3, the torque command value will be displayed here.

This is displayed as a percentage in respect to the motor's rated torque.

D11-4

ASR output monitor in %

The ASR output is displayed.

The forward run direction (drive) torque is displayed with a positive polarity, and the reverse run direction (regenerative) torque is displayed with a negative polarity.

This is displayed as a percentage in respect to the motor's rated torque.

D11-5

Torque setting monitor (after torque limiter) in %

The final torque command value after limiting with the torque limiter is displayed.

The forward run direction (drive) torque is displayed with a positive polarity, and the reverse run direction (regenerative) torque is displayed with a negative polarity.

This is displayed as a percentage in respect to the motor's rated torque.

D12-0

Slip monitor in %

The IM slip frequency is displayed as a percentage in respect to the base frequency.

D13-0

STP run monitor / STP step No. monitor

The step No. for STP operation is displayed.

STP displays during stoppage.

D13-1

STP run monitor / STP remaining pattern time monitor in min

Displays the time remaining until the end of the current pattern.

D13-2

STP run monitor / STP No. monitor

The currently selected STP No. is displayed.

D13-3

STP run monitor / STP average spindle frequency monitor in Hz

Displays the average frequency for each spindle.

D13-4

STP run monitor / STP hank count monitor

Displays the current Hank count. The display is limited at a maximum of 6553.5.

This is cleared to zero when the power is turned OFF.

D13-5

STP run monitor / STP total patter operating time monitor in min

Displays the operation time until now. The display is limited at a maximum of 65535.

This is cleared to zero when the power is turned OFF.

D14-0

Automatic torque bias setting in %

Displays the currently set torque bias value [B16-0 to B] at the analog/digital auto torque bias setting.

D15-0

Z-phase electric angle (PM motor drive) in °

The Z-phase electric angle is displayed.

Use this to adjust the Z-phase when using magnetic pole position estimation.

D16-0	Magnetic pole position estimation: Characteristics amount for magnetic pole position estimation 1 (PM motor drive)
D16-1	Magnetic pole position estimation: Characteristics amount for magnetic pole position estimation 2 (PM motor drive)
D16-2	Magnetic pole position estimation: Magnetic pole position estimation current (PM motor drive)
D16-3	Magnetic pole position estimation: Magnetic pole position estimation error (PM motor drive)

These parameters are used to adjust the magnetic pole position estimation function. Refer to section 3-4-4 for details.

D20-0 **Fault history monitor**

The fault history reference mode is entered by pressing the  key. The details are shown below.

Fault history No.	Displayed details	Explanation
E * 0	Details of primary fault	The error code for the primary fault cause is displayed.
E * 1	Details of secondary fault	The error code for the fault occurring secondarily is displayed.
E * 2	Output frequency at fault occurrence	Displayed with 0.01Hz unit.
E * 3	Output current value at fault occurrence	Displayed with 0.1A unit.
E * 4	DC voltage value at fault occurrence	Displayed with 1V unit.
E * 5	ASIC at fault occurrence	Display item is same as D05-0.
E * 6	Cumulative power ON time at fault occurrence	Displayed with 2 hour unit.
E * 7	Cumulative operation time at fault occurrence	Displayed with 10 min unit.

(Note) A number between 0 and 3 is substituted for * in the table to indicate faults up to three prior faults. * = 0 indicates the latest fault. Refer to section 4-2-8 LCD Panel and section 4-3-7 LED Panel for details on operations in this mode.

D20-1

Minor failure past record indication

Press the  key to enter the minor fault history reference mode.
The details are shown below.

Fault history No.	Displayed details	Explanation
M * 0	Current minor fault	The newly detected minor fault is displayed as shown below.
M * 1	All minor faults	All minor faults at M*0 occurrence are displayed as shown below.
M * 2	Output frequency at fault occurrence	Displayed with 0.01Hz unit.
M * 3	Output current value at fault occurrence	Displayed with 0.1A unit.
M * 4	DC voltage value at fault occurrence	Displayed with 1V unit.
M * 5	ASIC at fault occurrence	Display item is same as D05-0.
M * 6	Cumulative power ON time at fault occurrence	Displayed with 2 hour unit.
M * 7	Cumulative operation time at fault occurrence	Displayed with 10 min unit.

(Note) A number between 0 and 3 is substituted for * in the table to indicate faults up to three prior faults. * = 0 indicates the latest fault.

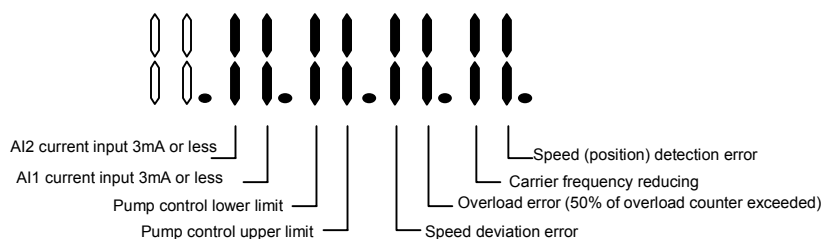

Monitor fault

D20-2

Parameter A, B and C modification list entry

Press  to enter the mode for referring to and changing parameters which differ from the default values.

D21-0

Cumulative conductivity time

The inverter power ON time after product shipment is counted and shown with a 1-hour unit.

D21-1

Cumulative run time

The inverter operation time after product shipment is counted and shown with a 1-hour unit.

D21-2

CPU version

D21-3

ROM version

Display for maker control.

D22-0

Automatic tuning progression display

The progress of automatic tuning is displayed as shown below.

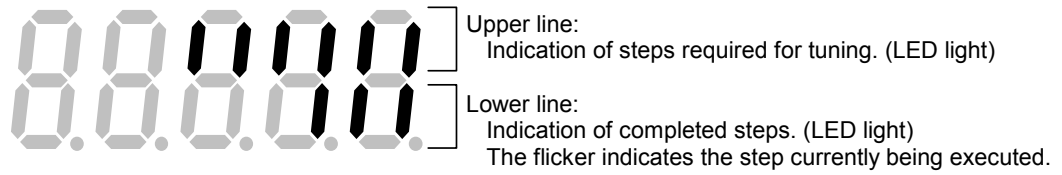

D30-0

Inverter type

The inverter capacity type is displayed.

D30-1

Option PCB

The mounted optional PCB is displayed.

Each segment of the LED corresponds to the optional PCB as shown below.

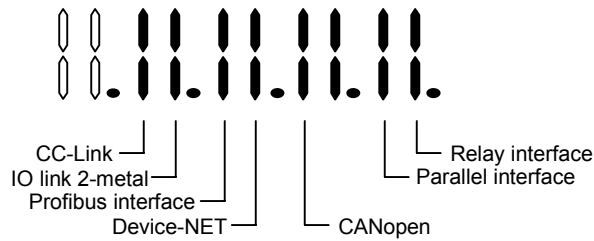

Option P.C.B. monitor (D30-1)





6-6-2 Explanation of Block-A parameter functions

A00-0
A00-2

Local frequency setting

Local speed setting

This is the frequency (V/f control mode) and speed (other control modes) set with the operation panel.

(Note 1) The operation panel speed change operation is set to "change at real time" (C11-2=1) as the factory setting, so the frequency and speed will change in real time when the   keys (LED panel) are pressed or  knob (LCD panel) are turned even without pressing the  key. If the  key is pressed, the setting value at that point will be saved.

(Note 2) This frequency and speed setting is validated when the speed setting input point is set in the panel. Refer to section 5-9-1 for details on the speed setting input point.

A00-1
A00-3

Jogging frequency

Jogging speed

This is the frequency (V/f control mode) and speed (other control modes) for carrying out jogging with the sequence command F.JOG and R.JOG.

A01-0, 1
A03-0~2
C01-0, 1

Acceleration/deceleration time - 1

DC brake setting

Start/stop frequency

- For V/f control mode (C30-0 $f_0=1$)

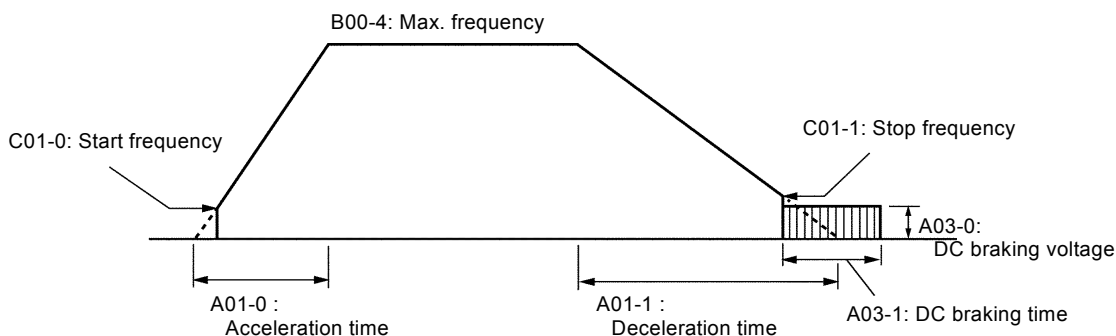

A01-1 sets the acceleration time from stop to the maximum frequency, and A01-1 sets the deceleration time from the maximum frequency to stopping. This is the acceleration/deceleration ramp time which is valid when the sequence command CSEL is OFF (factory setting). If the time is too short, the operation could trip with an overcurrent or overvoltage, so set an appropriate value which matches the motor and load inertia.

(Note) The acceleration/deceleration time for jogging (F.JOG, R.JOG) is set with the B10-2, 3 setting value.

For A03-0: DC brake voltage setting, set the output voltage for DC braking at stopping as a percentage in respect to the motor rated voltage.

This parameter is automatically adjusted with automatic tuning (mode 1 and mode 2).

When adjusting this parameter, monitor the output current and adjust in increments of 1% or less. An excessive setting could result in tripping.

* Refer to section 3-4-1 for details on automatic tuning in the V/f control mode.

6. Control Functions and Parameter Settings

For A03-1: DC brake time setting, set the time for carrying out DC braking during operation stop. If this parameter is 0.0, the motor will stop without DC braking.

C01-0: Start frequency setting is the output frequency setting value for starting operation. The output frequency is increased from this setting value.

When the output frequency reaches the C01-1:

Stop frequency setting when decelerating after the operation stop command (RUN=OFF), DC braking operation will start. When not using DC braking (A03-1 = 0.0), the motor will stop when this setting value is reached.

- For IM sensor-less vector control, IM vector control with sensor, PM motor control mode (C03-0 f_0 = 2 to 4)

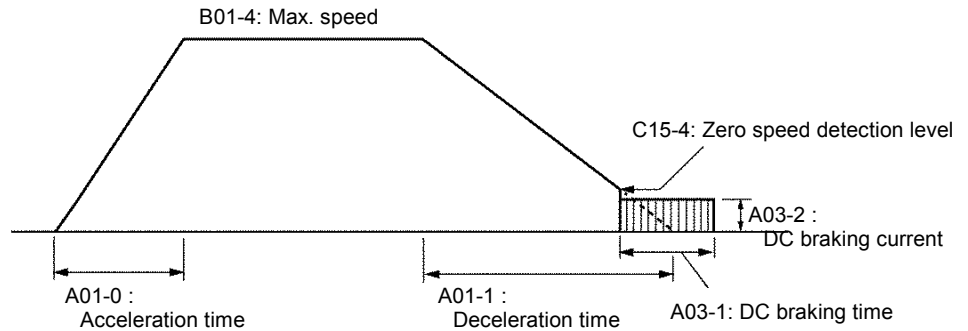

A01-1 sets the acceleration time from stop to the maximum frequency, and A01-1 sets the deceleration time from the maximum frequency to stopping. This is the acceleration/deceleration ramp time which is valid when the sequence command CSEL is OFF (factory setting). If the time is too short, the operation could trip with an overcurrent or overvoltage, so set an appropriate value which matches the motor and load inertia.

(Note) The acceleration/deceleration time for jogging (F.JOG, R.JOG) is set with the B10-2, 3 setting value.

For A03-1: DC brake time setting, set the time for carrying out DC braking during operation stop.

When the speed reaches the zero speed detection level (C15-4) setting value or less while decelerating after the operation stop command (RUN=OFF), DC braking will start. If this parameter is set to 0.0, the motor will stop without DC braking.

For A03-2: DC brake current setting sets the current value output during DC braking.

A02-0

Manual torque boost selection

This parameter selects the manual torque boost function.

This function is valid when A02-0 is set to 2, and is invalid when A02-0 is set to 1.

When manual torque boost is selected, the manual torque boost setting will be valid regardless of the automatic torque boost selection state.

A02-1

Automatic torque boost selection

This parameter selects the automatic torque boost function.

This function is valid when A02-1 is set to 2, and is invalid when A02-1 is set to 1.

When automatic torque boost is selected, the R1 drop compensation, slip compensation and maximum torque boost functions will be valid.

(Note 1) To validate only the slip compensation function when manual torque boost is selected, set all settings other than the slip compensation function (A02-5) to 0 (set A02-3, 4, 6 to 0).

(Note 2) The square reduction torque setting is always valid regardless of the torque boost selection state.

To invalidate the square reduction torque setting, set (A02-3) to 0.

6. Control Functions and Parameter Settings

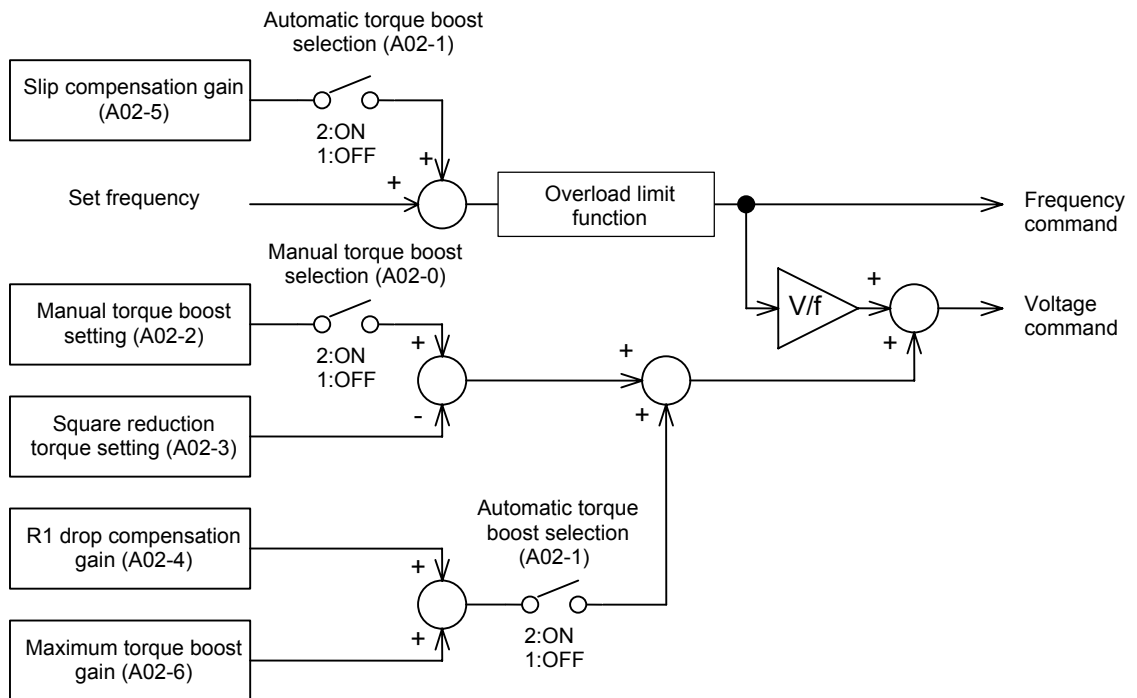

Torque boost selection block diagram

• Automatic torque boost function

The automatic torque boost function carries out voltage boosting and slip compensation using the current detection value. This allows the torque to be improved when starting and at low speed regions. By carrying out automatic turning, the gain, etc., for the automatic torque boost function will be automatically adjusted. Using this function, a 200% starting torque can be output with the Meidensha standard 3-phase induction motor during a 150% output current. Even with a motor that cannot output a 200% torque due to design, the maximum torque of the motor can be output. The main characteristics with the Meidensha standard 3-phase induction motor are shown below.

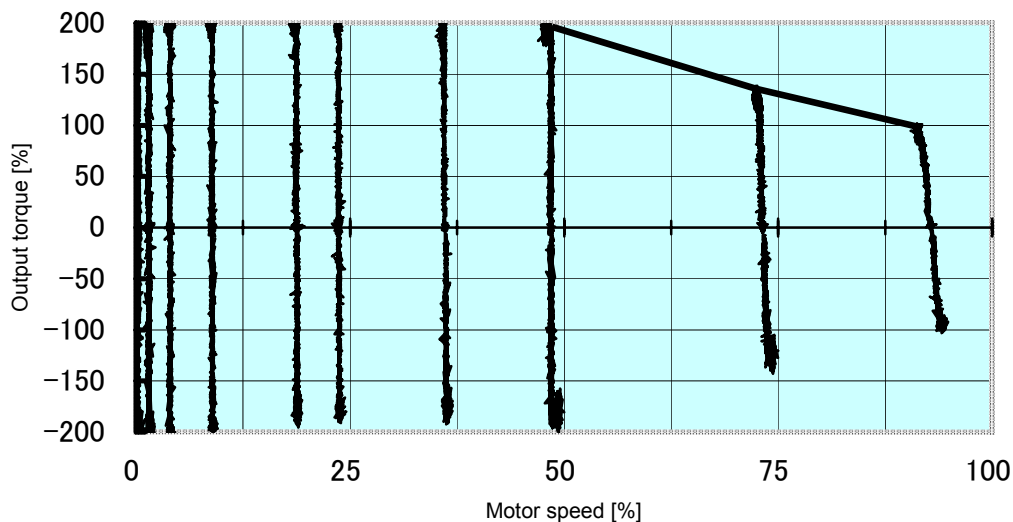

Output torque - motor speed characteristics
 <Meidensha standard 3-phase induction motor 30kW-4P>

⚠ CAUTION

- When using only manual torque boost, carry out automatic tuning (B19-0 = 1).
- When using automatic torque boost, always carry out automatic tuning (B19-0 = 2).
- The maximum torque is not output instantly. It takes approx. 3 seconds for the maximum torque to be reached.
- If the motor vibrates abnormally, etc., the automatic torque boost cannot be used.
- If the parameters automatically set with automatic tuning are set manually, the motor rotation could become unstable.
- With a motor with which the base frequency greatly exceeds the commercial frequency, or with a motor with a large constant output range, the rotation may be unstable and a sufficient torque may not be output.
- When outputting the maximum torque continuously, consider the heat generated on the motor side, etc.

A02-2

Manual torque boost setting [%]

This parameter is automatically adjusted with automatic tuning (mode 1 and mode 2). When adjusting this parameter, set the boost voltage at 0Hz as a percentage in respect to the rated output voltage (B00-3).

* Refer to section 3-4-1 for details on automatic tuning in the V/f control mode.

A02-3

Square reduction torque setting [%]

Set the reduction torque at the base frequency (B00-5)/2 as a percentage in respect to the rated output voltage (B00-3).

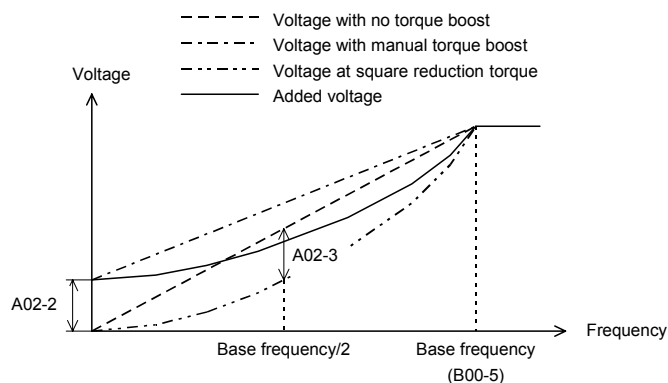

When both A02-2 and A02-3 are set, the voltage will be added as shown below.

A02-4

R1 drop compensation gain [%]

Set how much to compensate the voltage drop caused by R1 (B02-0, 1: Motor primary resistance value) measured with automatic tuning. Normally set 100% of the default value.

(Note 1) If the setting is too high, the rotation may become unstable, and the inverter may trip.

(Note 2) Sufficient torque might not be attained if the setting is too small.

A02-5

Slip compensation gain [%]

This parameter is automatically adjusted with automatic tuning (mode 2).

When setting manually, set the slip frequency for the motor rated load as a percentage in respect to the base frequency (B00-5).

The output frequency changes according to the motor rated torque as shown below.

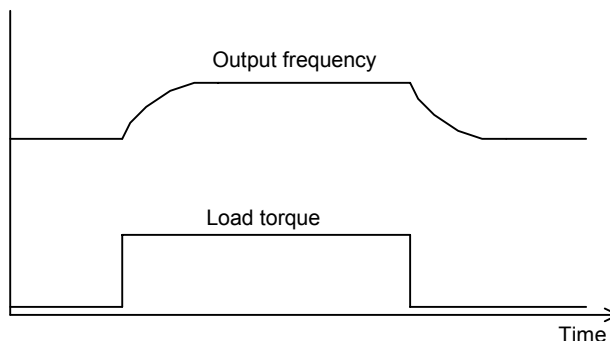

(Note 1) The output frequency will respond with a time constant of approx. 500ms in respect to the changes in the load torque.

(Note 2) When set too high, the motor rotation could become instable.

* Refer to section 3-4-1 for details on automatic tuning in the V/f control mode.

A02-6

Maximum torque boost gain [%]

This parameter is automatically adjusted with automatic tuning (mode 2).

Set the optimum boost amount for the maximum torque output as a percentage in respect to the rated output voltage (B00-3).

Normally, a value of 10 to 30% is set by automatic tuning.

(Note 1) When adjusted manually, the sufficient torque may not be attained.

(Note 2) If set too high, the rotation may become unstable and may trip.

* Refer to section 3-4-1 for details on automatic tuning in the V/f control mode.

A04-0~7

Custom parameters

C10-0~7: The parameters selected with the custom parameter selection can be displayed.

This parameter does not appear if this setting is not made.

Refer to section 4-7 for details.

A05-0~2

Parameter B and C indicatory skip

The parameter display is skipped for each function in the extended functions, software option functions and hardware option functions.

Unnecessary displays can be reduced with this parameter, allowing operation to be simplified.

All displays are set to skip as the default.

A10-0

ASR response

This is used to calculate the gain of the ASR.

The computing expression for the ASR gain and integral time constant is shown below.

ASR gain :

$$K_p = \text{ASR response (A10-0) [rad/s]} \times \frac{\text{Machine time constant } T_m \text{ (A10-1 or B15-0) [ms]}}{1000}$$

ASR integral time constant :

$$T_i = \frac{4}{\text{ASR response (A10-0) [rad/s]}} \times \frac{\text{Compensation coefficient (A10-2)[\%]}}{100}$$

A10-1

Machine constant – 1

This is used to calculate the ASR gain.

This parameter is valid when the sequence command MCH is OFF. The B15-0 setting value is valid when MCH is ON.

$$T_m [\text{msec}] = \frac{10.97 \times J [\text{kgm}^2] \times (\text{Nbase}[\text{min}^{-1}])^2}{\text{Power} [\text{W}]}$$

T_m : Machine time constant
 J : Total inertia (=1/4 X GD^2 [kgfm²])
 Nbase : Base speed
 Power : Motor rated output

A10-2

ASR integral time constant compensation coefficient

Set the compensation coefficient for the ASR integral time constant calculated with ASR response (A10-0). Refer to the computing expression for the ASR integral time constant and set.

A10-3

ASR drive torque limiter

A10-4

ASR regenerative torque limiter

A10-5

ASR emergency stop regenerative torque limiter

A11-2

ACR drive torque limiter

A11-3

ACR regenerative torque limiter

Set the limit value for each torque limiter in ASR control.

If the sequence command ACR is OFF, the A10-3 and A10-4 setting values are the torque limit value, and if ACR is ON, the A11-2 and A11-3 setting values are the torque limit value.

If the emergency stop method is set to deceleration stop (C00-4=3) and the sequence command EMS turns ON, the A10-5 setting value will be the torque limit value.

The acceleration/deceleration time may be longer than the set value depending on these torque limiter values.

(Note) The inverter output current is limited by the overcurrent limit value (B18-0), so the torque may not be generated until the value set in this parameter is reached.

A11-0

ACR response in rad/s (IM vector control)

A20-0

ACR response in rad/s (PM motor control)

A11-1

ACR time constant in ms (IM vector control)

A20-1

ACR time constant in ms (PM motor control)

The ACR gain and time constant are set. This will affect the current response. If the gain is too low or too high, the current will become unstable, and the over current protection will function. Normally adjust the response between 500 and 1000 rad/s, and the time constant between 5 and 20ms.

A20-2

d axis current command cushion time in ms/l1 (PM motor control)

A20-3

q axis current command cushion time in ms/l1 (PM motor control)

This is the cushion setting to prevent instability caused by overshooting, etc., when the current command changes suddenly. Set at how many ms to change the current command value equivalent to the motor rated current. Normally, a value 5ms or more is set.

6-6-3 Explanation of Block-B parameter functions

B00-0
B01-0

Rated input voltage setting

B00-0 is used to select the rated input voltage from the following table in the V/f control mode (C30-0 f_0 = 1), and B01-0 is used to select the rated input voltage in all other control modes (C30-0 f_0 = 2 to 4).

Small size (0P7H to 055H, 0P7L to 045L)

B00-0 or B00-1 Setting value	200V system	400V system
1	200V	380V
2	200V	400V
3	220V	415V
4	220V	440V
5	230V	460V
6	240V	480V
7	230V	400V

Large size (075H or more, 055L or more)

B00-0 or B00-1 Setting value	200V system	400V system
1	200V	380V
2	200V	400V
3	220V	415V
4	220V	440V
5	230V	460V
6	240V	480V
7	230V	400V

When the B00-0 setting value is changed (when parameter change is entered and  key is pressed), the B00-3 setting value is changed to the same value. In the same manner, if B01-0 is changed, the B01-3 setting value is changed.

B00-1

Max./base frequency simple setting

The base frequency and maximum frequency combination can be selected as shown below. To set a combination not shown in the table, set B00-1 to 0.

Value	Ftrq [Hz]	Fmax [Hz]
0	Free setting on B00-4 and B00-5	
1	50	50
2	60	60
3	50	60
4	50	75

Value	Ftrq [Hz]	Fmax [Hz]
5	50	100
6	60	70
7	60	80
8	60	90
9	60	120

B00-2
B01-1

Motor rated output

Select the motor's rated output at the base frequency and rotation speed.

B01-2

No. of motor poles

Set the number of poles indicated on the motor nameplate.

B00-3

Motor rated voltage

B01-3

Set the rated voltage indicated on the motor nameplate.

If this parameter is set to 39, the output voltage at the base frequency and rotation speed will be the input voltage.

If a value other than 39 is set, the output voltage at the base frequency and rotation speed will be controlled to the value set with this parameter.

If the rated input voltage setting (B00-0, B01-0) is changed, this value is also changed to the rated input voltage value. This cannot be set higher than the rated input voltage.

B00-4

Max. frequency (Fmax)

B01-4

Max. speed (Nmax)

B00-5

Motor rated frequency (Fbase)

B01-5

Base speed (Nbase)

Set the motor's base/maximum frequency and speed.

- **V/f control mode (C30-0 f_0 = 1)**

Set B00-4, B00-5. This parameter setting is valid only when B00-1 is set to 0.

The B00-5 minimum value is B00-4/7 Hz or 1.0 Hz, whichever is larger, and the maximum value is B00-4 Hz or 440.0 Hz, whichever is smaller.

The B00-4 minimum value is B00-5 Hz or 3.0 Hz, whichever is larger, and the maximum value is B00-5x7 Hz or 440.0 Hz, whichever is smaller.

- **IM sensor-less vector control mode (C30-0 f_0 = 2)**

Set B01-4, B01-5. The B01-5 minimum value is B01-4/2 or 150 min⁻¹, whichever is larger, and the maximum value is B01-4 or 9999 min⁻¹, whichever is smaller.

The B01-4 minimum value is B01-5 or 150 min⁻¹, whichever is larger, and the maximum value is B01-5x2 or 9999 min⁻¹, whichever is smaller. And the maximum value is determined by the number of motor poles. The speed is limited where the synchronous frequency is 180Hz.

- **IM vector control with sensor mode (C30-0 f_0 = 3)**

Set B01-4, B01-5. The B01-5 minimum value is B01-4/4 or 150 min⁻¹, whichever is larger, and the maximum value is B01-4 or 9999 min⁻¹, whichever is smaller.

The B01-4 minimum value is B01-5 or 150 min⁻¹, whichever is larger, and the maximum value is B01-5x4 or 9999 min⁻¹, whichever is smaller. And the maximum value is determined by the number of motor poles. The speed is limited where the synchronous frequency is 180Hz.

- **PM motor control mode (C30-0 f_0 = 4)**

Set B01-4, B01-5. The B01-5 minimum value is B01-4/1.5 or 150 min⁻¹, whichever is larger, and the maximum value is B01-4 or 9999 min⁻¹, whichever is smaller.

The B01-4 minimum value is B01-5 or 150 min⁻¹, whichever is larger, and the maximum value is B01-5x1.5 or 9999 min⁻¹, whichever is smaller. And the maximum value is determined by the number of motor poles. The speed is limited where the synchronous frequency is 210Hz.

B00-6

Motor rated current

B01-6

Set the rated current indicated on the motor nameplate.

This is the reference for the overcurrent limit, motor overload standard and analog output, etc.

(Note) The minimum of this parameter is a value of “inverter rating current × 0.3 in a Heavy-Duty overload setting”.

B00-7

B01-7

Carrier frequency

The PWM carrier frequency and control method can be changed to change the tone of the magnetic sound generated from the motor. The relation of the setting range and control method is shown below.

- 1) For 0P4H~045H, 0P4L~037L
 - 1.0 to 15.0 : Mono sound method (Actual carrier frequency: 1.0 to 15.0kHz)
 - 15.1 to 18.0 : Soft sound method 1 (Basic carrier frequency: 2.1 to 5.0kHz)
 - 18.1 to 21.0 : Soft sound method 2 (Basic carrier frequency: 2.1 to 5.0kHz)
- 2) For 055H and larger, 045L and larger
 - 1.0 to 8.0 : Mono sound method (Actual carrier frequency: 1.0 to 8.0kHz)
 - 8.1 to 11.0 : Soft sound method 1 (Basic carrier frequency: 2.1 to 5.0kHz)
 - 11.1 to 14.0 : Soft sound method 2 (Basic carrier frequency: 2.1 to 5.0kHz)

[Mono sound method]

This control method has a constant PWM carrier frequency. When a low carrier frequency is set, an annoying magnetic sound may be generated.

[Soft sound method]

This control method changes the PWM carrier frequency at a set cycle. As the frequency elements of the magnetic sound is dispersed, the tone is similar to a cicada. If the beat sound that is generated due to the operation frequency is annoying, there may be cases when the beat sound can be suppressed by changing between method 1 and 2.

- (Note 1)** When the carrier frequency automatic reduction function is used, the carrier frequency may be reduced automatically by 2.0kHz depending on the output current or inverter temperature. This function is valid only when c22-6 is set to 1. The reduction function is enabled as the factory setting. The setting value and actual carrier frequency may differ, so check the actual carrier frequency with D03-3. The reduction conditions according to each capacity are shown below.
- 0P7H to 5P5H, 0P7L to 5P5L
When the power module temperature exceeds 110°C, the carrier frequency is automatically decreased by 2.0kHz.
 - 7P5H to 022H, 7P5L, 011L
When the power module temperature exceeds 85°C, the carrier frequency is automatically decreased by 2.0kHz.
 - 030H or more, 015L or more
When the heat sink temperature exceeds 75°C and the output current is 110% or more of the inverter rating, or when the heat sink temperature exceeds 95°C, the carrier frequency is automatically decreased by 2.0kHz.
* Check the power module and heat sink temperature with D02-4.
- (Note 2)** If the output voltage is low (output frequency is low), the actual carrier frequency may be lower than the set carrier frequency. Check the actual carrier frequency with D03-3.
- (Note 3)** There are cases when the effect of noise onto the inverter's peripheral devices can be reduced by lowering the carrier frequency.
- (Note 4)** If set to higher than the specified carrier frequency, the output current must be deleted. Refer to Fig. 1-2 and Fig. 1-3 in Appendix 1 for details.

B01-8

No. of encoder pulses

The number of pulses per rotation of the encoder in use is set.

B01-9

No-load output voltage

The The motor terminal voltage during no-load at the base speed is set.

B02-0~9

Motor circuit constant (IM)

The IM equivalence circuit: T type and T-I type equivalence circuit, and the T type equivalence circuit → T-I type equivalence circuit conversion expression is shown below.

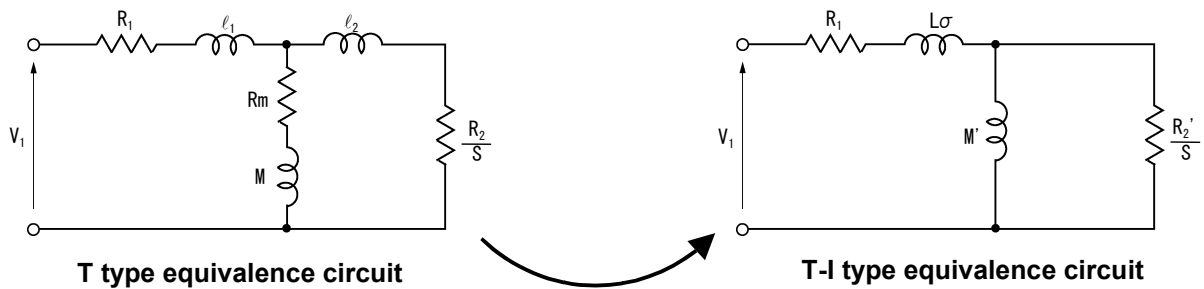

$$M' = M^2 / (\ell_2 + M)$$

$$L\sigma = (\ell_1 + M) - M^2 / (\ell_2 + M)$$

$$R_2' = \left(\frac{M}{\ell_2 + M} \right)^2 \cdot R_2$$

With the VT240S, the circuit constants for the T-I type equivalence circuit are set. The parameters set according to the circuit constants are shown below.

Symbol	Name	Setting parameter
R1	Primary resistance	B02-0, B02-1
R2'	Secondary resistance	B02-2, B02-3
Lσ	Leakage inductance	B02-4, B02-5
M'	Excitation inductance	B02-6, B02-7
Rm	Iron loss resistance	B02-8, B02-9

Of these parameters, B02-0 to B02-7 can be automatically adjusted with automatic tuning. Refer to Chapter 3 for details on automatic tuning. If automatic tuning is not possible, and for the iron loss resistance: B02-8, 9, refer to the above diagram and expression, and the motor design value, and set the appropriate value.

B03-0~5

Motor circuit constant (PM)

Refer to section 6-9-3 for details on setting the PM motor circuit constants.

B05-0~5

Frequency skip

By setting this parameter, the motor's mechanical resonance point at a specific frequency can be skipped. Valid only during V/f control.

Refer to the following diagram, and set each parameter.

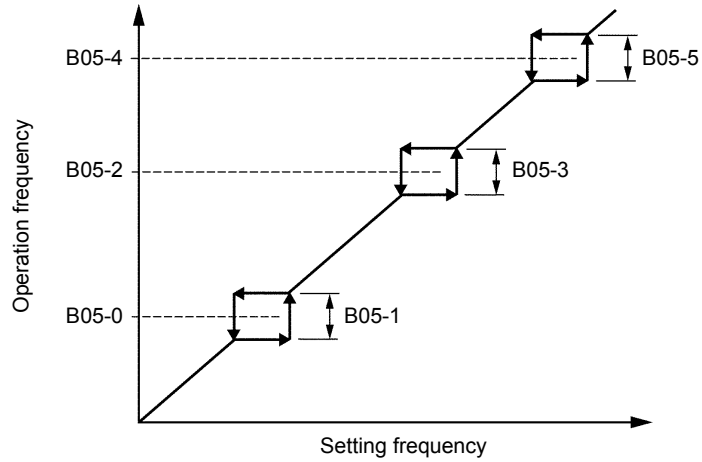

(Note) This function controls the frequency setting, so the above skip frequency area will be passed with a ramp function.

B06-0~E

Ratio interlock setting

The ratio interlock operation executes the following expression and corresponds to each speed setting input signal.

$$Y = AX + B + C$$

X: Frequency (speed) setting input
 Y: Frequency (speed) command
 (operation results)

A: Coefficient
 B: Bias 1
 C: Bias 2

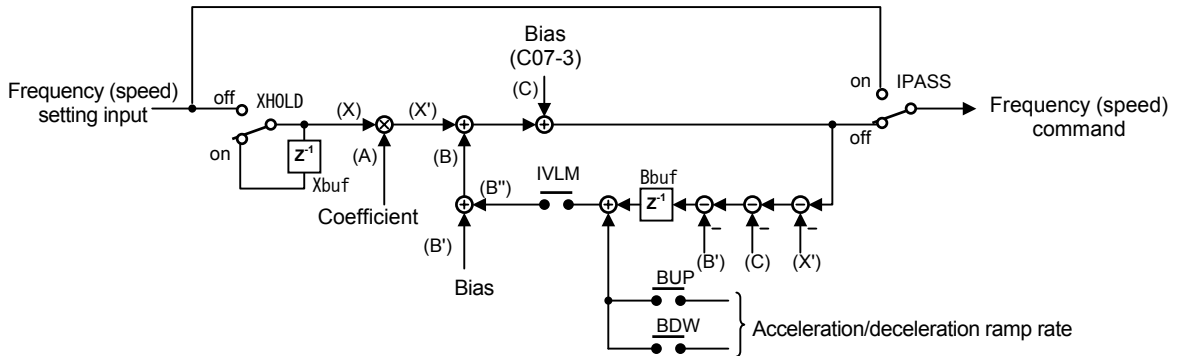

Sequence input
 IPASS : Ratio interlock bypass (C03-A)
 BUP : Ratio interlock bias increase (C04-9)
 BDW : Ratio interlock bias decrease (C04-A)
 IVLM : Ratio interlock bias increase/decrease selection (C04-B)

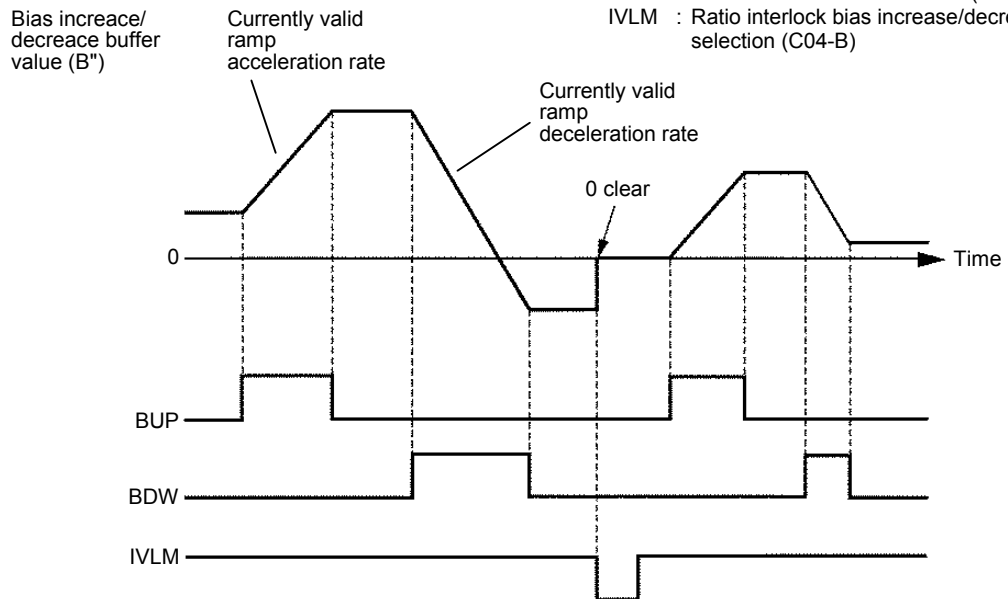

(Ratio interlock bias increase/decrease function)

- When IVLM turns ON, the bias value increased or decreased by BUP/BDW is added to the ratio interlock bias value (B') as the above (B'').
- If BUP turns ON while IVLM is ON, the bias increase/decrease buffer value (B'') increases with the currently valid acceleration ramp rate. When BDW turns ON, the bias increase/decrease buffer value (B'') decreases with the currently valid deceleration ramp rate.
- If both BUP and BDW turn OFF while IVLM is ON, the current bias increase/decrease buffer value (B'') is held.
- If IVLM turns OFF, the current bias increase/decrease buffer value (B'') is cleared to zero, and the BUP and BDW operations are ignored.
- Even when the operation command (RUN) turns OFF, the current bias increase/decrease buffer value (B'') is cleared to zero. The BUP and BDW operations are also ignored in this case.

6. Control Functions and Parameter Settings

The frequency and speed setting to which the ratio interlock setting is applied, and the set parameters are shown below.

	Coefficient (A)	Bias (B)	
		During V/f control	During IM vector, PM motor control
Analog speed setting 1	B06-0	B06-1	B06-2
Analog speed setting 2	B06-3	B06-4	B06-5
Analog speed setting 3	B06-6	B06-7	B06-8
Serial speed setting	B06-9	B06-A	B06-B
Pulse train input speed setting	B06-C	B06-D	B06-E

Refer to section 5-9-1 for details on selecting the frequency and speed setting value.

(Note 1) If the frequency and speed command value is incremented or decremented by this function, the upper limit and lower limit are the maximum frequency and speed.

(Note 2) When using the auxiliary drive function, this function is automatically passed, and cannot be used.

B07-0~3

Upper/Lower limit setting

Set the upper limit and lower limit for the frequency and speed command value. This setting is valid for all speed command values including analog inputs and serial inputs.

	During V/f control	During IM vector control, PM motor control
Upper limit setting value	B07-0	B07-2
Lower limit setting value	B07-1	B07-3

B10-0

Acceleration ramp time –2

B10-1

Deceleration ramp time –2

B10-2

Acceleration ramp time for jogging

B10-3

Deceleration ramp time for jogging

The acceleration/deceleration ramp time can be switched by turning the sequence command CSEL ON. Set the CSEL command input terminal with C03-9.

The ramp time for jogging (F•JOG, R•JOG) can be set independently with B10-2 and -3.

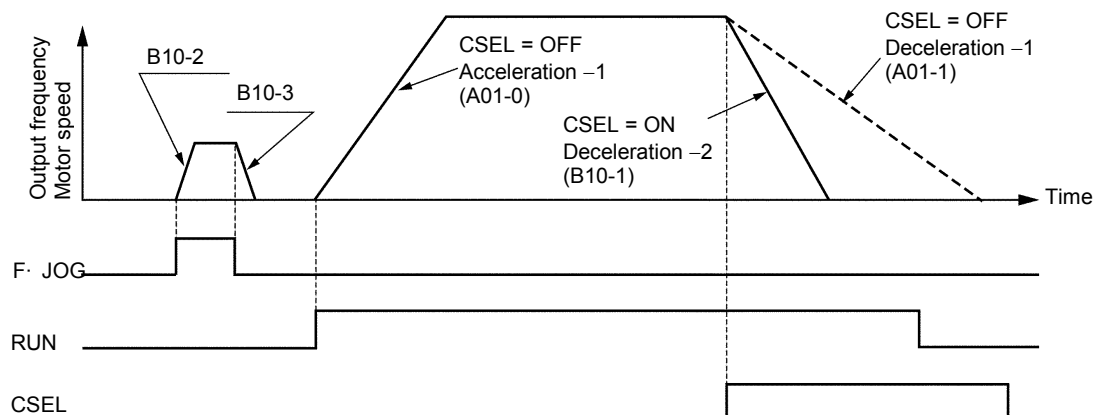

(Note) The ramp time is set as the acceleration/deceleration time for 0Hz to maximum frequency (B00-4) and 0 to maximum speed (B01-4) in either case.

B10-4

S-shape characteristics

Acceleration/deceleration with the S-shape pattern is possible by setting this parameter.

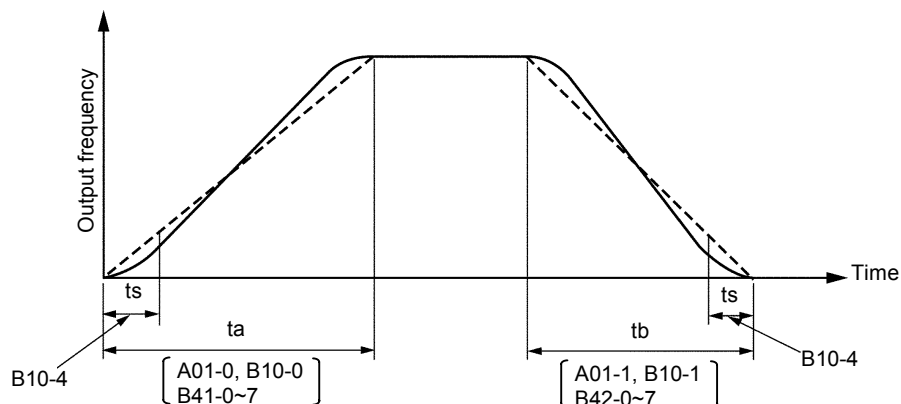

This parameter indicates the time of the section shown with t_s above. The total acceleration/deceleration times t_a and t_b will not change. When this parameter is set, all acceleration and deceleration will be as shown above.

(Note 1) Set so that the relation of the B10-4 setting and acceleration/deceleration time is as shown below.

$$\text{B10-4 Setting value } (t_s) \times 2 \leq \text{acceleration/deceleration time } (t_a, t_b)$$

(Note 2) When the rotation direction command has been changed, or when the polarity of the frequency or speed command value has been reversed, the zero frequency and zero speed are passed through. The acceleration/deceleration time will be smaller than the set acceleration/deceleration ramp time (t_a, t_b).

B10-5

Time unit multiplier

The acceleration/deceleration time setting unit can be changed when an acceleration/deceleration time in a wider range is to be set.

- B10-5 = 1 (standard): × 1
- 2 : × 0.1
- 3 : × 10

This parameter will affect all acceleration/deceleration time parameters.

B10-6

S-shape ramp pass function

This function is valid only when the external brake function selection is turned ON with B46-0. If this parameter is validated when using the S-shape ramp function (when B10-4 setting value is not 0), the S-shape will be passed during specific operations, and instead the normal ramp operation will take place.

- B10-6 = 1 This function is disabled.
- = 2 The S-shape is passed when the program frequency setting function is used and the sequence command S0 to SE is selecting the B11-0 frequency.
- = 3 S-shape is used only during the acceleration at the start of operation or acceleration/deceleration when the frequency is changed. The S-shape is passed in all other cases.

B11-0~7
B11-8

Program frequency (speed) setting
Selection mode setting

This is the frequency • speed setting for when running program run (multi-step frequency • speed setting) by turning the sequence command PROG ON. Set B11-0 to B11-7 using the maximum frequency (B00-4) or maximum speed (B01-4) as 100%. When using the auxiliary drive function, set each maximum frequency setting value as 100%. The set frequency and speed are selected according to the following table by sequence command S0, S1, S2, S3, SE and B11-8.

(1) For binary mode (B11-8 = 1)

Sequence command					Selected frequency
SE	S3	S2	S1	S0	
*	*	OFF	OFF	OFF	B11-0
		OFF	OFF	ON	B11-1
		OFF	ON	OFF	B11-2
		OFF	ON	ON	B11-3
		ON	OFF	OFF	B11-4
		ON	OFF	ON	B11-5
		ON	ON	OFF	B11-6
ON	ON	ON	B11-7		

* : SE and S3 are not used.

(2) For direct select mode (B11-8 = 2)

Sequence command					Selected frequency
SE	S3	S2	S1	S0	
OFF	OFF	OFF	OFF	OFF	Previous values
OFF	OFF	OFF	OFF	ON	B11-0
OFF	OFF	OFF	ON	OFF	B11-1
OFF	OFF	ON	OFF	OFF	B11-2
OFF	ON	OFF	OFF	OFF	B11-3
ON	OFF	OFF	OFF	OFF	Previous values
ON	OFF	OFF	OFF	ON	B11-4
ON	OFF	OFF	ON	OFF	B11-5
ON	OFF	ON	OFF	OFF	B11-6
ON	ON	OFF	OFF	OFF	B11-7

When S0 to S3 are all OFF, or when two or more are set between S0 and S3, the previous values will be held. If there are no previous values because the power has been turned ON, etc., "0" will be set.

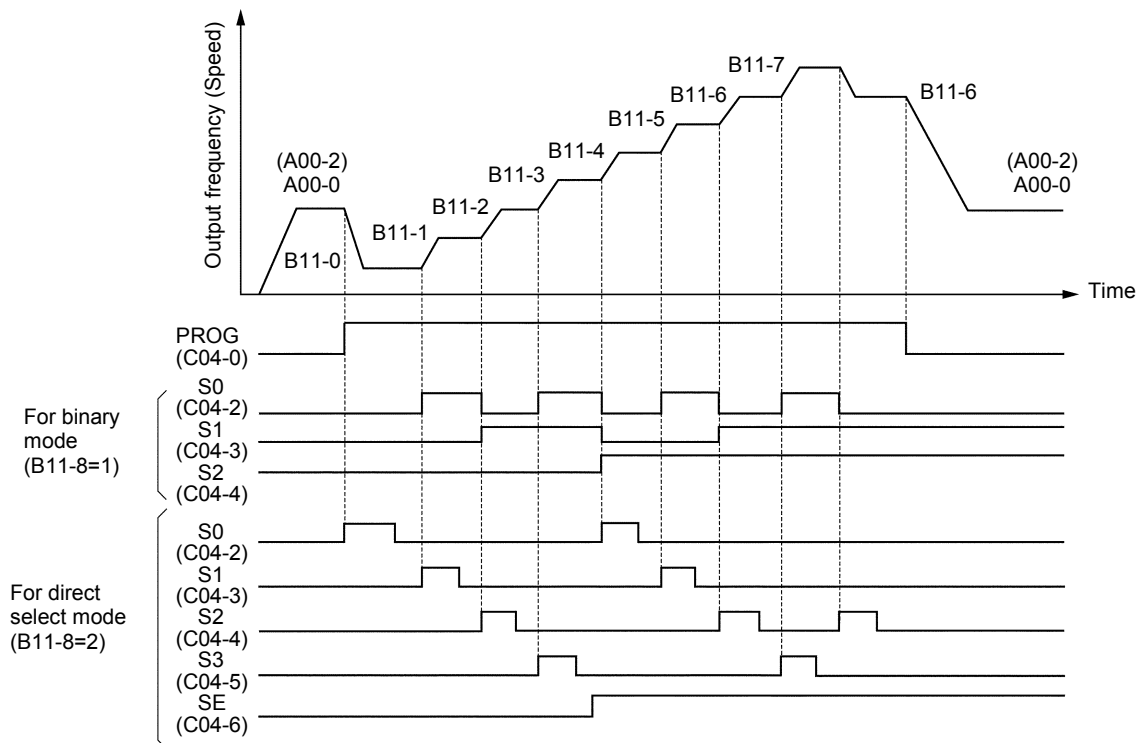

Program run example (When RUN is ON)

Set the sequence command PROG input terminal with C04-0. Set the S0, S1, S2, S3 and SE input terminals with C04-2 to C04-6. The B11-8 setting is also reflected on the program ramp function (B41-x, B42-x) program mode settings.

B12-0~6

Automatic braking on power failure function

The decelerate at power failure function is valid when B12-0 is set to 2. This setting is also applied when using the auxiliary drive function. This function executes the following operations automatically.

- (1) Operation starts when a power failure occurs, and the DC voltage drops below the value (%) set with B12-1.
- (2) The value set with B12-4 is subtracted from the output voltage when the power failure occurs, and is set as the output frequency.
- (3) Note that if the output frequency at the power failure is less than the value set with B12-5, the value will not be subtracted.
- (4) The motor decelerates to the frequency set with B12-6 at the time set with B12-2.
- (5) The motor decelerates and stops at the time set with B12-3.
- (6) Note that if the frequency set with B12-6 is less than the stop frequency, the motor will decelerate and stop at the time set with B12-2.

(Note 1) Once this operation is started, the VT240S will continue this even after the power is restored.

(Note 2) To restart after stopping, cancel the RUN command once.

(Note 3) The "FWD", "REV" and "STOP" commands during this operation are invalid from both the operation panel and sequence terminal block. "EMS" is valid.

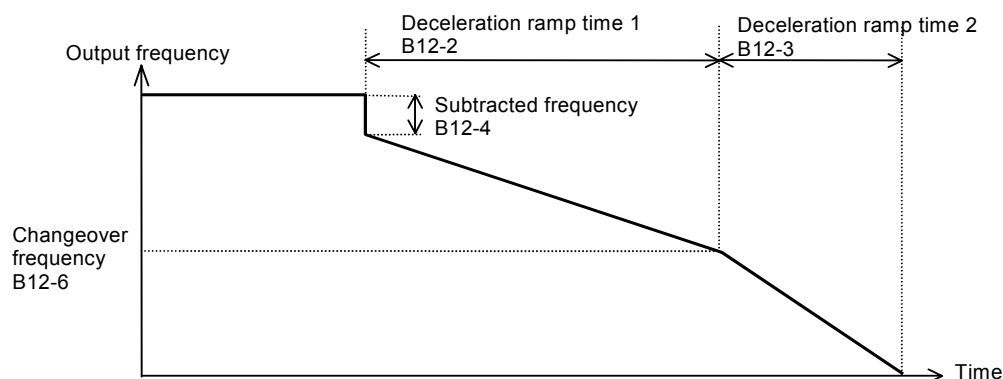

When using the auxiliary drive function, substitute the parameter No. as shown below, and set according to each auxiliary drive mode.

(Note 4) When using this function and the auxiliary drive function during vector control or PM motor control, set B12-0 and B12-1.

Main drive	Auxiliary drive 0	Auxiliary drive 1	Auxiliary drive 2	Auxiliary drive 3
B12-2	B23-0	B27-0	B2B-0	B2F-0
B12-3	B23-1	B27-1	B2B-1	B2F-1
B12-4	B23-2	B27-2	B2B-2	B2F-2
B12-5	B23-3	B27-3	B2B-3	B2F-3
B12-6	B23-4	B27-4	B2B-4	B2F-4

B13-0

Torque setting

This is the torque set by the operation panel.

This setting value is used as the torque command value when C02-2 is set to 3 (default value).

Refer to section 5-9-2 for details on selecting the torque setting.

B13-1

Torque ratio 1 setting

Set the torque ratio for the panel parameter (B13-0).

Refer to section 5-9-5 for details on selecting the torque ratio 1 setting.

B13-2

Torque bias 1 setting

Set the torque bias for the panel parameter (B13-0).

Refer to section 5-9-3 for details on selecting the torque bias 1 setting.

B13-3

Torque ratio 2 setting

Refer to section 5-9-6 for details on selecting the torque ratio 2 setting.

B13-4

Double rating speed ratio setting

Refer to section 5-9-4 for details.

B13-5

Drooping setting

Set the drooping value within the range of the following expression. If it becomes unstable, adjust the drooping setting value or the related parameters.

$$\frac{\text{Drooping setting value (B13-5) [\%]}}{100 [\%]} \times \text{ASR response (A10-0) [rad/s]} \times \frac{\text{Machine time constant (A10-1 or B15-0) [ms]}}{1000} < 0.5$$

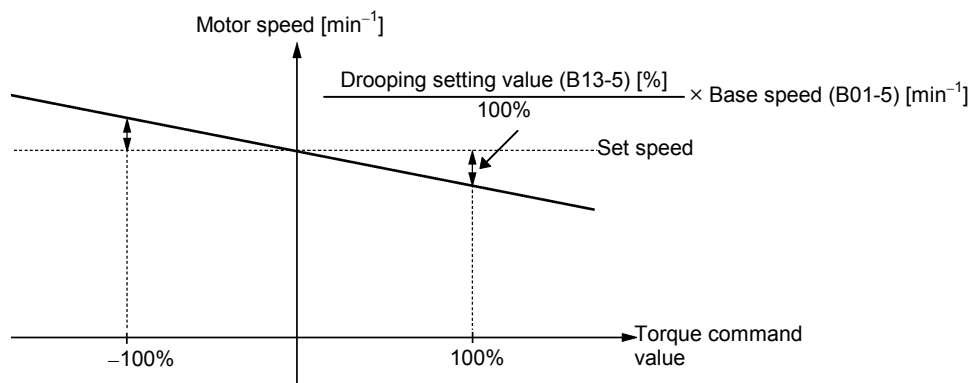

B13-6

ASR gain compensation in constant power range

B13-7

ACR gain compensation in constant power range

This setting compensates the ASR and ACR gain in the constant output range (speed above base speed).

Refer to the following diagram and set the ASR gain compensation with B13-6 and the ACR gain compensation with B13-7.

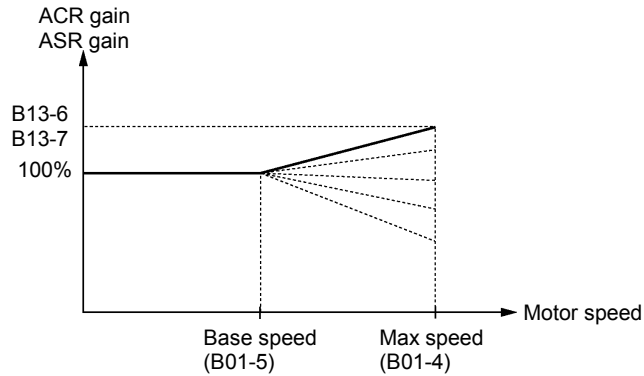

B13-8, 9

Linear torque limit

Refer to section 6-9-5 for details on these parameters.

B14-0

ASR dead band setting

A dead band zone can be set for the speed control amplifier input with this parameter. Set this dead band zone parameter as a percentage in respect to the base speed. Refer to Fig. 5-3 for details on the speed control.

B15-0

Machine time constant 2

This is used to calculate the ASR amplifier gain. When the relay input machine time constant changeover is ON (MCH is ON), the machine time constant set with this parameter is valid.

$$T_m [\text{msec}] = \frac{10.97 \times J [\text{kgm}^2] \times (\text{Nbase}[\text{min}^{-1}])^2}{\text{Power} [\text{W}]}$$

T_m : Machine time constant
 J : Total inertia (=1/4 X GD^2 [kgfm^2])
 Nbase : Base speed
 Power : Motor rated output

When MCH is OFF, the A10-1 (machine time constant -1) setting value is valid.

B16-0~B

Automatic torque bias control

This function is used to apply torque bias from the start of operation based on the load feedback prior to operation. This prevents rotation due caused by the load that results when releasing the elevator brake. Either analog or digital load feedback can be selected. Auto torque bias control calculates the torque bias value from the load feedback (digital/analog). The torque bias is then fixed when performing operation. The torque bias does not vary during operation, and is revised gradually during stoppage.

(1) Setting the automatic torque bias function

When the load feedback is obtained as a digital value using a limit switch, etc., use the digital torque bias.

When the load feedback is obtained as an analog value, use the analog torque bias. Refer to the following diagram and set B16-0.

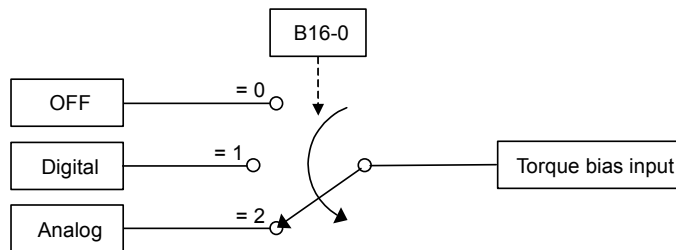

(2) Selecting the torque bias direction

The torque bias direction can be selected with B16-6. If the motor forward runs when the elevator rises, set B16-6 to 1. If the motor reverse runs, set B16-6 to 2.

(3) Setting the parameters for digital torque bias selection

The torque bias value is set with the digital input using sequence inputs S5 to S7 as shown below.

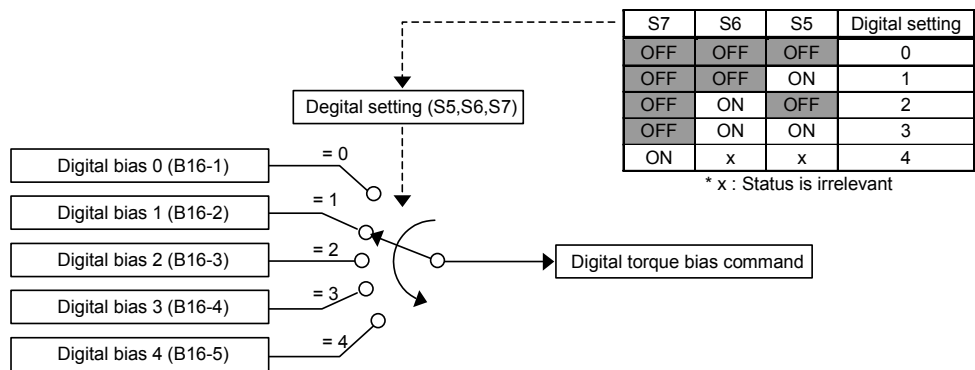

Set the torque bias value with B16-1 to B16-5.

Set the input terminals for the S5 to S7 signals with C05-0 to 2 as shown below.

Sequence input	Setting parameter
S5	C05-0
S6	C05-1
S7	C05-2

6. Control Functions and Parameter Settings

(4) Setting the parameters for analog torque bias selection

When the load feedback is obtained as an analog value, use the analog torque bias. Set the analog torque bias input terminals (AI1, AI2, AI3) with C07-A. Set the voltage and current input, full scale and filter time constants for the input terminals used with C12-0 to C12-A.

Refer to the following diagram and set B16-7 to B. B16-7 to 9 (analog bias voltage) is set as a ratio in respect to the full scale of the input terminal being used.

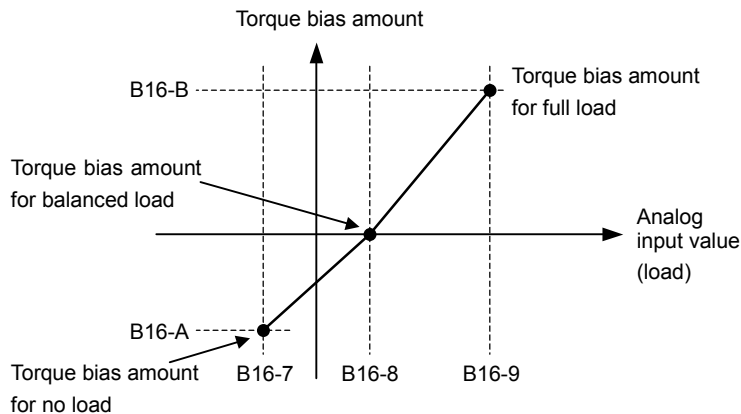

Example of analog input and torque bias amount relation

B17-0~B

V/f middle point

When using a motor with special V/f characteristics, the special V/f characteristics can be set as shown below by using this function.

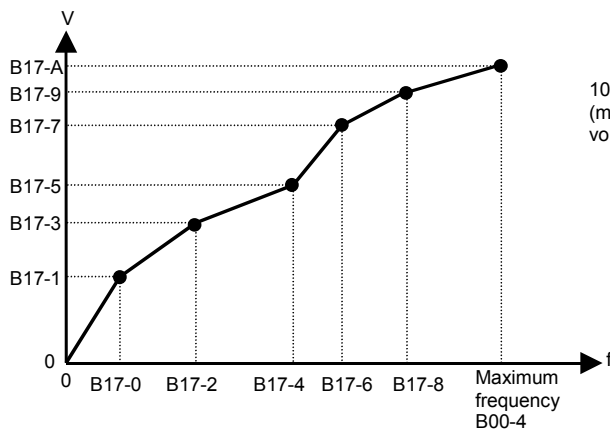

V/f characteristics when using middle V/f function

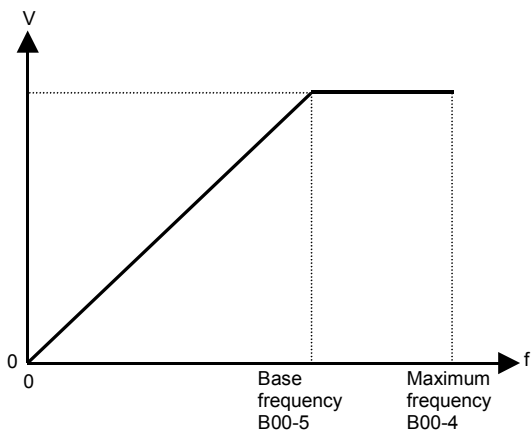

Normal V/f characteristics

Set B17-B to 2 to use this function.

Refer to the upper left diagram, and set the frequency and voltage in B17-0 to A. Set the voltage as a percentage in respect to the motor rated voltage (B00-3).

If this function is OFF (normal V/f control), the base frequency will be 100% voltage (motor rated voltage), and the maximum frequency will be 100% voltage as shown in the upper right diagram.

6. Control Functions and Parameter Settings

When using four or less V/f changeover points, set the setting value to "0.00" in the order of B17-0 → B17-2 → B17-4 → B17-6.

If all of the frequency settings (B17-0, 2, 4, 6, 8) are set to "0.00", the V/f characteristics will be the 100% voltage (motor rated voltage) at the base frequency, and the B17-A setting voltage at the maximum frequency.

A setting example is shown below.

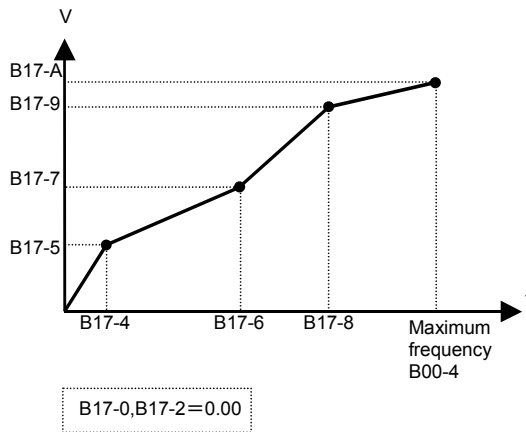

When using 3 V/f changeover points

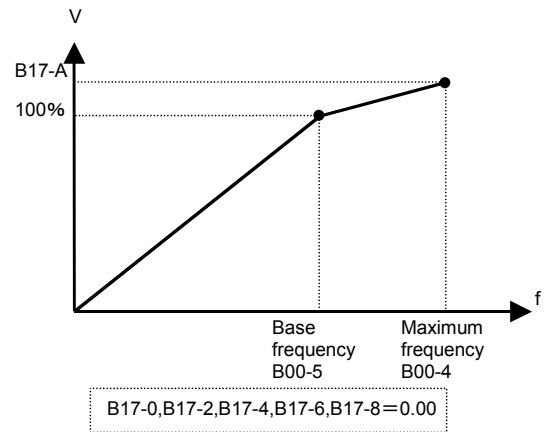

When not setting a V/f changeover point

The range for each frequency setting value is limited so that the relation $B17-0 \leq B17-2 \leq B17-4 \leq B17-6 \leq B17-8 \leq B00-4$ is established.

(Note) The V/f middle point function cannot be used with the auxiliary drive function.

B18-0	Over current limit
B18-3	Over current limit function gain
B18-4	Current stabilization gain
B18-5	Over current stall prevention gain
B18-6	Over current stall prevention time constant
B18-7	Drive current limit level 2
B18-8	Drive current limit level 3

The over current limit is a function that lowers the output frequency and suppresses the current so that the motor current does not exceed this parameter setting value during starting or constant running. The setting uses the motor rated current (B00-6) as 100%.

(Note) Set a value larger than the motor no-load current.

The overcurrent limit function is configured of the following three control blocks.

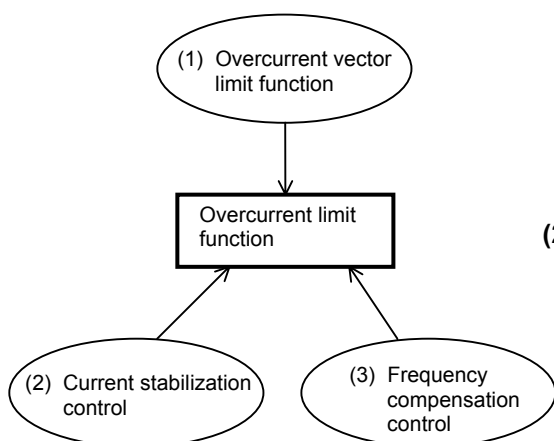

(1) Overcurrent vector limit function

This uses the overcurrent as a vector, and generates a suppressing voltage vector instantly to suppress the current. The response is adjusted with the over current limit gain (B18-3).

Normally, set the default value (0.25).

If the setting value is increased, the response will become faster, but the operation may become unstable.

(2) Current stabilization control

This suppresses the sudden changes in the current phase during overcurrent suppression by controlling the output frequency. The response is adjusted with the over current stabilization gain (B18-4).

Normally, set the default value (0.25).

If the setting value is increased, the torque vibration will be reduced, but the operation may become unstable.

(3) Frequency compensation control

This feeds back the voltage suppressed with the overcurrent vector limit function to the frequency command and prevents stall. The response is adjusted with the over current stall prevention gain (B18-5) and over current stall prevention time constant (B18-6).

Normally, set the default value (B18-5 = 100, B18-6 = 100).

If the gain setting value (B18-5) is increased or the time constant value (B18-6) is decreased, the response will become faster, but the operation may become unstable.

(Note) The overcurrent limit function is valid at all times regardless of whether automatic tuning has been executed.

B18-1

Regenerative current limit

The regenerative torque to deceleration running is limited. Set to 10% when not using the DB option. When using the DB option, calculate the value with the following formula and set.

$$\text{B18-1 setting value} = \left[\left(\frac{\sqrt{V_2}}{\text{DBR resistance value}} \right) / \text{Motor capacity [kW]} \right] \times 100 [\%]$$

where $V_2=148.2$ for the 200V system and $V_2=593$ for the 400V system.

B18-2

Torque stabilization gain

This function suppresses the hunting phenomenon that causes the current to abnormally vibrate during motor operation.

Normally, the default value (1.00) is set, but increase the setting value in increments of approx. 0.05 according to the state of hunting.

Please return to regulated value (1.00) of a set value once, and reduce it by carving about 0.05 when the hunting phenomenon is not controlled even in case of maximum value (4.00). Note that the hunting phenomenon occurs easily in the following cases.

- During a light load or no load
- When the system inertia is low
- When the motor's secondary time constant is high (high-efficiency motor)
- When carrier frequency is high

(Note) The hunting phenomenon at a frequency exceeding 66Hz cannot be suppressed.

B19-0

Automatic tuning function

Refer to Chapter 3 for details on automatic tuning

B19-1

Initial proportion compensation gain (Automatic tuning function)

B19-2

Initial time constant compensation gain (Automatic tuning function)

When the motor with special circuit parameters is applied, the initial condition of automatic tuning is set. Change these value if auto tuning is completed incorrectly and try to auto tuning again. Set these values to increase or decrease with 50% step.

**B20-0 ~
B2F-4**

Various settings for auxiliary drive 0 to 3

Refer to section 6-10 for details on the auxiliary drive function.

B30-0

Load torque observer gain

B30-1

Model machine time constant

B30-0 sets the observer gain for the load torque observer.

To increase the responsiveness of the external disturbance response characteristics, set a large gain.

Note that if the gain is set too high, the output torque could hunt.

When set to zero, the load torque observer will not function.

Set the model machine time constant used with the B30-1 load torque observer.

Refer to section 6-8-7 for details on the load torque observer function.

B30-2

ASR proportional item change rate limit

If the speed setting value or motor speed change suddenly, this will prevent the ASR's P item from suddenly changing.

B30-3

Speed setting LPF time constant

Set the low path filter time constant for the speed setting value. Overshooting can be suppressed by setting this to the filter time constant equivalent to the speed response.

B30-4

Speed detection LPF time constant

The speed detection noise is cut at the set time constant.

B30-5

Speed detection LPF time constant for ASR

Set the low path filter time constant used for the speed detection value input into the speed regulator.

B30-6

Speed detection LPF time constant for compensation

Set the low path filter time constant used for the speed detection value for constant output range compensation or iron loss compensation, etc.

B30-7

Torque current command setting LPF time constant

Set the low path filter time constant used for the torque current command.

B30-8

LPF time constant for drooping

Set the low path filter time constant used for drooping value input into the speed regulator.

B31-0

Flux observer gain

This is the feedback gain for the flux observer. If hunting occurs at the estimated speed in the high-speed operation range, adjust within the range of 1.2 to 0.9.

B31-1

Speed estimated proportional gain

This is the proportional gain for the adaptive speed estimation mechanism. To increase the speed estimation response, set a large value. Note that if the value is too high, the speed estimation value will hunt.

B31-2

Speed estimated integral gain

This is the integral gain for the adaptive speed estimation mechanism. To increase the speed estimation response, set a large value. Note that if the value is too high, the speed estimation value will hunt.

B31-3~4

Regenerative compensation torque limiter 1, 2

B31-5~6

Regenerative compensation low-speed area setting 1, 2

The regenerative torque limiter can be changed in the low-speed area. The shaded section shows the operation range. If operation is unstable within the shaded line range, set the parameter so that the unstable point is not within the shaded line area.

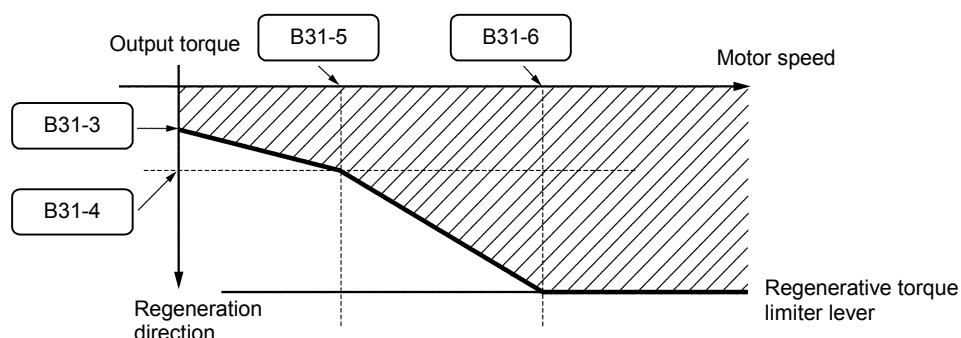

B32-0

High-speed flux control gain

(IM sensor-less vector control, IM vector control with sensor)

= 1: Disable = 2 to 50: Enable

This is the control gain used for high-speed control of the secondary flux when starting operation.

Use this to control the secondary flux at a high speed at the start of operation or during operation in a constant output range.

High speed control is possible by increasing the gain, but if increased too high, the magnetizing current may hunt.

B32-1

Temperature compensation selection

(IM sensor-less vector control, IM vector control with sensor)

= 1: Disable = 2: Enable

If torque accuracy is required when vector control with sensor is selected (C30-0 f_0 = 3, 4), or if speed accuracy is required when sensor-less vector control is selected (C30-0 f_0 = 2, 5), the parameter fluctuation of the primary resistance value and secondary resistance value caused by a rise in temperature can be compensated.

B32-2

Voltage saturation compensation selection

(IM sensor-less vector control, IM vector control with sensor)

= 1: Disable = 2: Enable

If the output voltage in control is larger than the voltage that can be output by the inverter, select this control to limit the exciting current to prevent the current or torque from hunting.

Select this when raising the output voltage to near the input voltage, or when the input voltage changes.

Note that if voltage saturation occurs, some torque ripple will occur. In this case, lower the B01-9 no-load voltage setting to avoid voltage saturation.

B32-3

Iron loss compensation selection (IM sensor-less vector control, IM vector control with sensor)

= 1: Disable = 2: Enable

This compensates the torque error caused by iron loss. The iron loss resistance value (B02-8, 9) must be set.

B32-4

ACR voltage model FF selection (IM sensor-less vector control, IM vector control with sensor, PM motor control)

= 1: Disable = 2: Enable

The voltage fluctuation caused by the leakage inductance is feed forward controlled.

The current regulator (ACR) response speed will be increased. Select this if the current hunts in the high-speed operation range during sensor-less control.

Use this function if the current hunts at a high-speed operation range during the IM sensor-less vector control mode.

When using this function with the PM motor control mode, set B32-4 to 2 and B32-5.

B32-5

ACR model voltage FF compensation (PM motor control)

dq axis current non-interference voltage

Set this when the ASR proportional gain is high.

Set the value between approx. 50.0 and 80.0%.

This function is invalid when 0% is set.

B32-6

ACR proportional section dead time compensating factor (PM motor control)

Set a value of approx. 50 to 80% if current vibration at a 3ms cycle occurs at an output frequency of 120Hz or more.

B33-0~7

M fluctuation compensation table reference speed

This is the reference speed for changing the compensation amount according to the operation speed.

If all of B34 is set to the default value (100.0), these will be automatically set when adjusted with automatic tuning mode 4 (B19-0=4).

B34-0~7

M fluctuation compensation

This compensates the exciting inductance fluctuation according to the B33 table reference speed.

Set the compensation table so that the output voltage is constant during no-load operation through the entire operation range.

* This is adjusted with the automatic tuning mode 4 (B19-0 = 4).

Refer to Chapter 3 for details on automatic tuning.

B35-0~4

Voltage saturation prevention control constant

B36-0~6

Field weakening electric current table (PM motor control)

B38-0~6

Torque to Iq conversion adjustment coefficient table (PM)

Refer to section 6-9 for details on these parameters.

B39-0~3

Magnetic pole position estimation (PM)

Refer to section 3-4-4 for details on these parameters.

B40-0

Software option function

One of the following functions, program ramp, pattern operation, traverse operation, PID or multi-pump can be selected as a software option function.

Set the parameters as shown below to use these functions.

Parameter No.	Setting value	Function	Parameter related to function
B40-0	1	Function not used	-
	2	Program ramp	B41-0 to B42-7
	3	Pattern run	B50-0 to B59-3
	4	Traverse run	B45-0 to 6
	5	PID control	B43-0 to A
	6	Multi-pump control No main pump rotation	B43-0 to B44-6
	7	Multi-pump control (1-contact method) No main pump rotation	
	8	Multi-pump control (2-contact method) No main pump rotation	

B41-0~7

Program ramp – acceleration

B42-0~7

Program ramp – deceleration

The motor can be run with program frequency (speed) setting 0 to 7 using the sequence commands PROG and S0, S1, S2, S3, SE and selection mode setting (B11-8). The program ramp time can also be switched at this time and the motor run.

When the sequence command PROG is OFF, only the RAMP time is changed by S0, S1, S2, S3 and SE. The acceleration/deceleration ramp time selected with S0, S1, S2, S3 or SE is as shown below.

This function operates even when using the auxiliary drive function.

(1) For binary mode (B11-8 = 1)

Sequence command					Selected frequency
SE	S3	S2	S1	S0	
*	*	OFF	OFF	OFF	B41-0 B42-0
		OFF	OFF	ON	B41-1 B42-1
		OFF	ON	OFF	B41-2 B42-2
		OFF	ON	ON	B41-3 B42-3
		ON	OFF	OFF	B41-4 B42-4
		ON	OFF	ON	B41-5 B42-5
		ON	ON	OFF	B41-6 B42-6
		ON	ON	ON	B41-7 B42-7

* : SE and S3 are not used.

(2) For direct select mode (B11-8 = 2)

Sequence command					Selected frequency
SE	S3	S2	S1	S0	
OFF	OFF	OFF	OFF	OFF	Previous values
OFF	OFF	OFF	OFF	ON	B41-0 B42-0
OFF	OFF	OFF	ON	OFF	B41-1 B42-1
OFF	OFF	ON	OFF	OFF	B41-2 B42-2
OFF	ON	OFF	OFF	OFF	B41-3 B42-3
ON	OFF	OFF	OFF	OFF	Previous values
ON	OFF	OFF	OFF	ON	B41-4 B42-4
ON	OFF	OFF	ON	OFF	B41-5 B42-5
ON	OFF	ON	OFF	OFF	B41-6 B42-6
ON	ON	OFF	OFF	OFF	B41-7 B42-7

When S0 to S3 are all OFF, or when two or more are set between S0 and S3, the previous values will be held. If there are no previous values because the power has been turned ON, etc., "0" will be set.

An example of combination with the program frequency (speed) setting is shown below.

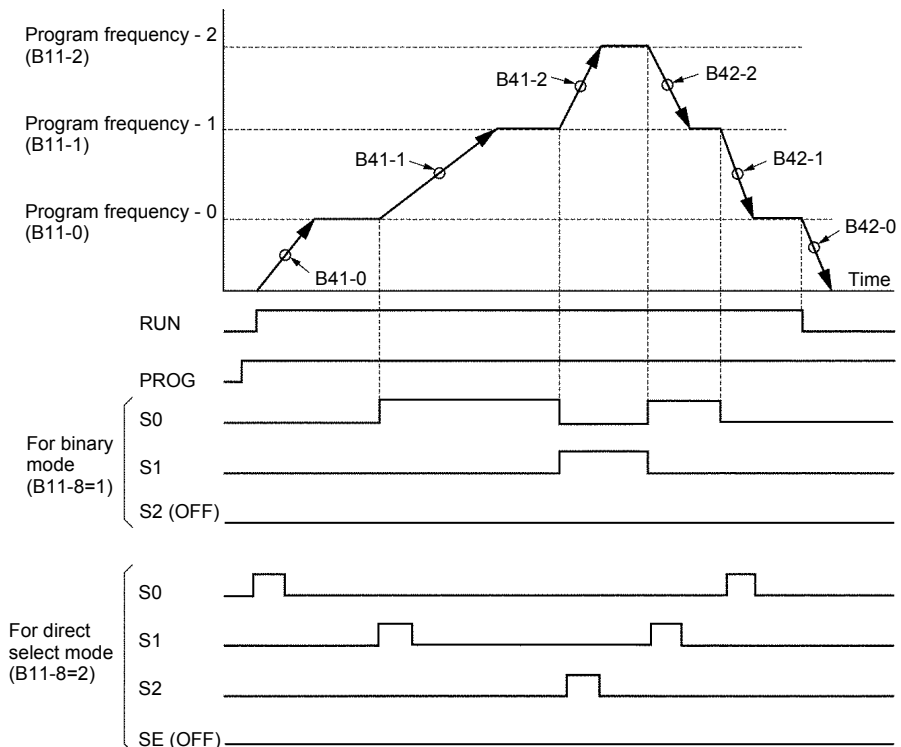

(Note) The acceleration/deceleration ramp time-2 (B10-0, 1) will be selected by turning the sequence command CSEL ON even when using the program ramp (B40-0=2).

B43-0~A

PID control

1) Basic PID control operation

The following type of feedback loop can be configured by using the analog input (AI1, AI2, AI3) as a feedback input.

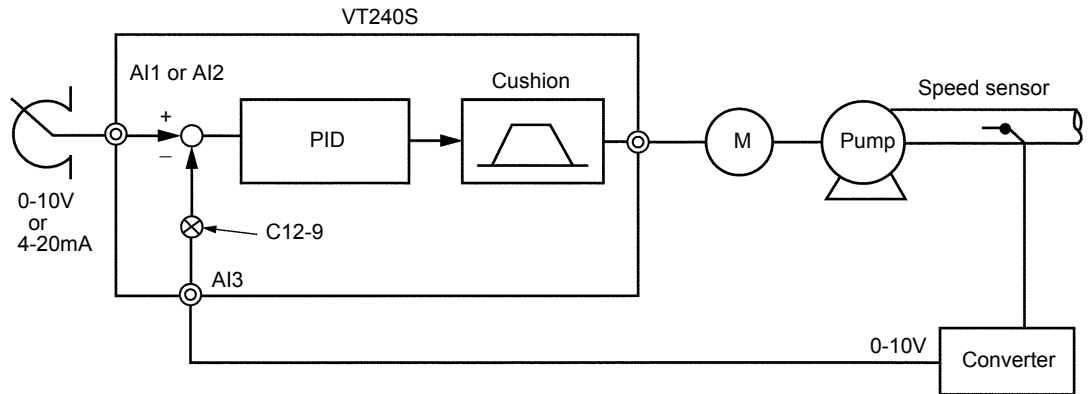

Example of PID control configuration

- (Note 1)** PID control functions only in the remote mode (LCL OFF). It does not function during the local mode (LCL ON). In this case, the normal operation mode is entered.
- (Note 2)** For PID control, either the mode which operates with the sequence command PIDEN and RUN, or the mode which operates with only PIDEN can be selected with B43-9.
- (Note 3)** When using the mode which operates with the sequence command PIDEN and RUN, the PID control will not start even if JOG or BRAKE are turned ON.
() What about the auxiliary drive?

The PID operation block is shown below.

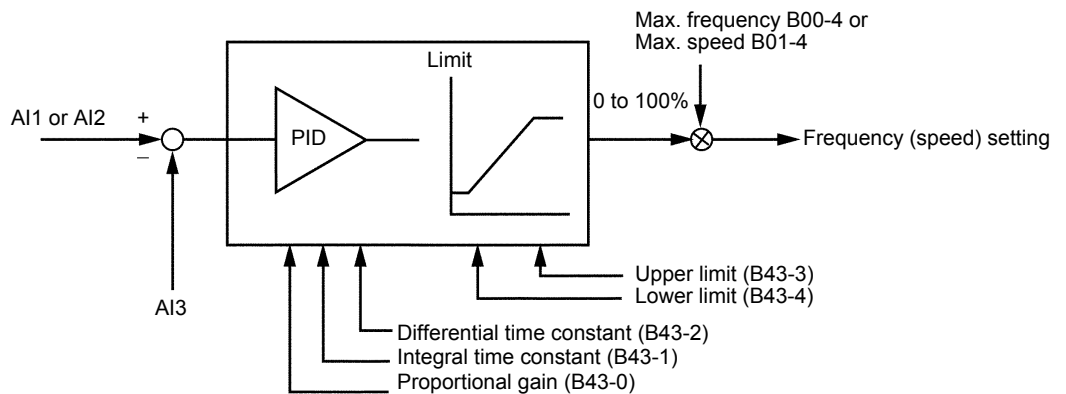

- (1) To validate or invalidate PID control during operation, turn the sequence input command PIDEN ON or OFF. The sequence input command PIDEN is assigned to the sequence input terminals with C03-C.
- (2) Refer to Fig. 5-9-1 and select the setting input. The speed setting input can be changed between the parameter setting and sequence input.
If the setting value is a Hz unit, the percentage conversion value using the maximum frequency B00-4 as 100% will be input.

- (3) Set the analog input to be used as the feedback input with C07-5.
Set the level of the analog input to be used with C12-1, 2 for AI1 and C12-5, 6 for AI2.
When inputting AI3 input, set the feedback input between 0 and 10V when C12-8 is 1, and between 0 and 5V when C12-8 is 2.
- (4) The internal signal (lower limit over: LLMT, upper limit over: ULMT), which indicates that the feedback value has exceeded the upper limit (B43-3) and lower limit (B43-4) can be output as a sequence. Set either 24 (LLMT) or 25 (ULMT) for C13-2 to 6.

2) Detected error determination

If PID detection is defective, an error is determined and a breakdown stop (IO-C) occurs.

An error is determined if when the command value is the same or higher than the error determination start level (B43-5), the detected value is the same or lower than the detected error level (B43-6), and the error condition continues for just the detected error determination time (B43-7), and a breakdown stop occurs.

3) Polarity invert flag

The PID input polarity can be inverted using B43-8. The normal PID input is the command value – the detected value, however, this changes to detected value – command value when the polarity is inverted.

4) PID operation selection method

The PID operation conditions can be changed using B43-9 f_0 .

$f_0=1$: PID operates when PIDEN=ON and RUN=ON.

$f_0=2$: PID operates when PIDEN only is ON.

(PID operation continues even during stop)

PID output based operation/stop can be performed using B43-9 f_1 .

$f_1=1$: Normal operation (Operation stop not performed by PID)

$f_1=2$: PID output is used to stop operation.

Stop occurs when the PID output reaches the lower limiter.

Stop occurs when the PID output reaches the lower limiter in the case when B43-9 f_1

$f_0 = 21$. Set RUN=OFF and then RUN=ON once again in order to restart operation.

Stop occurs automatically when the PID output reaches the lower limiter in the case when B43-99 f_1 $f_0 = 22$. Furthermore, operation is restarted when the PID output exceeds the lower limiter + hysteresis (B43-A). Set RUN=OFF to completely stop the motor.

B44-0~6

Multi-pump control

Multi-pump control refers to a function which controls the flow passage pressure at a constant level by running pumps in parallel using one VT240S and the VT240S' internal relay output (standard 5 points, option 4 points).

The pressure step of the ON/OFF controlled pumps is interpolated by a pump that is variable-speed controlled by the VT240S, which has the PID control function. This maintains the pressure's continuation.

Three types of VT240S multi-pump control can be selected with the B40-0 setting.

- B40-0=6: Main pump with no rotation function
- B40-0=7: Main pump with rotation function, 1-contact method
- B40-0=8: Main pump with rotation function, 2-contact method

1) B40-0=6: Main pump with no rotation function

Up to 9 pumps are run in parallel using one VT240S and the VT240S' internal relay output's 8 points. When main pump with no rotation is selected, the pump controlled with variable speed is fixed.

The system configuration is shown below.

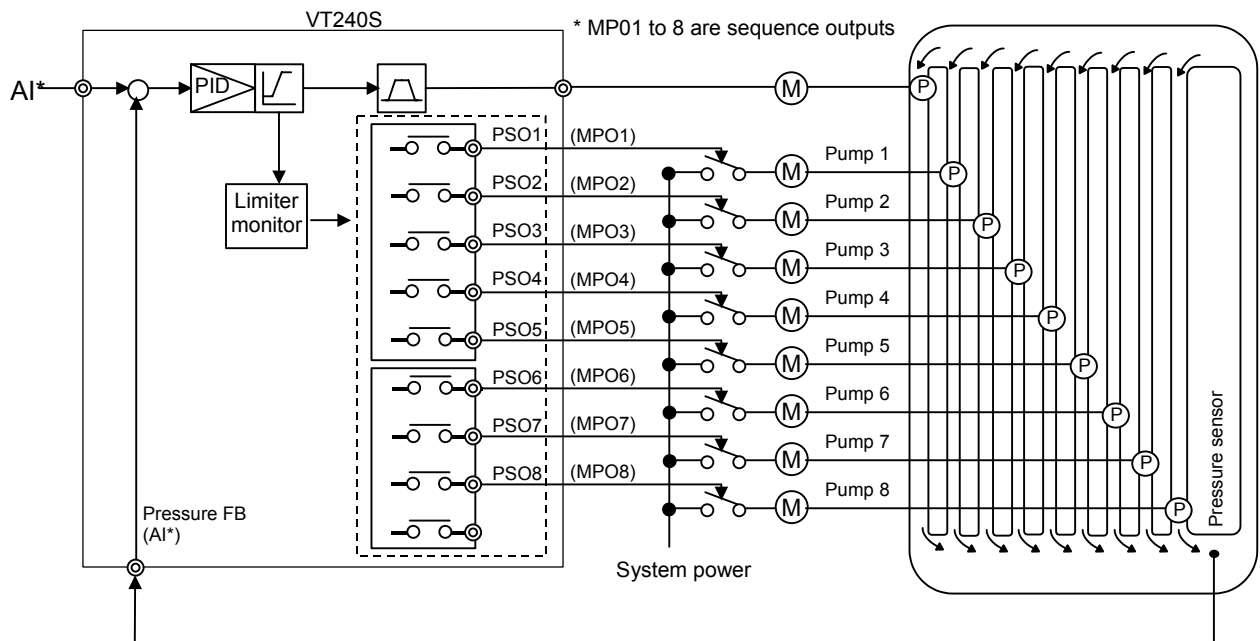

Example of system configuration (When operating nine ON/OFF control pumps)

6. Control Functions and Parameter Settings

2) B40-0=7: Main pump with rotation function, 1-contact method

Up to 8 pumps are run in parallel using one VT240S and the VT240S' internal relay output's 8 points. When main pump with rotation is selected, the pump controlled with variable speed is switched to the least operating pump only when all pumps are stopped.

The system configuration is shown below.

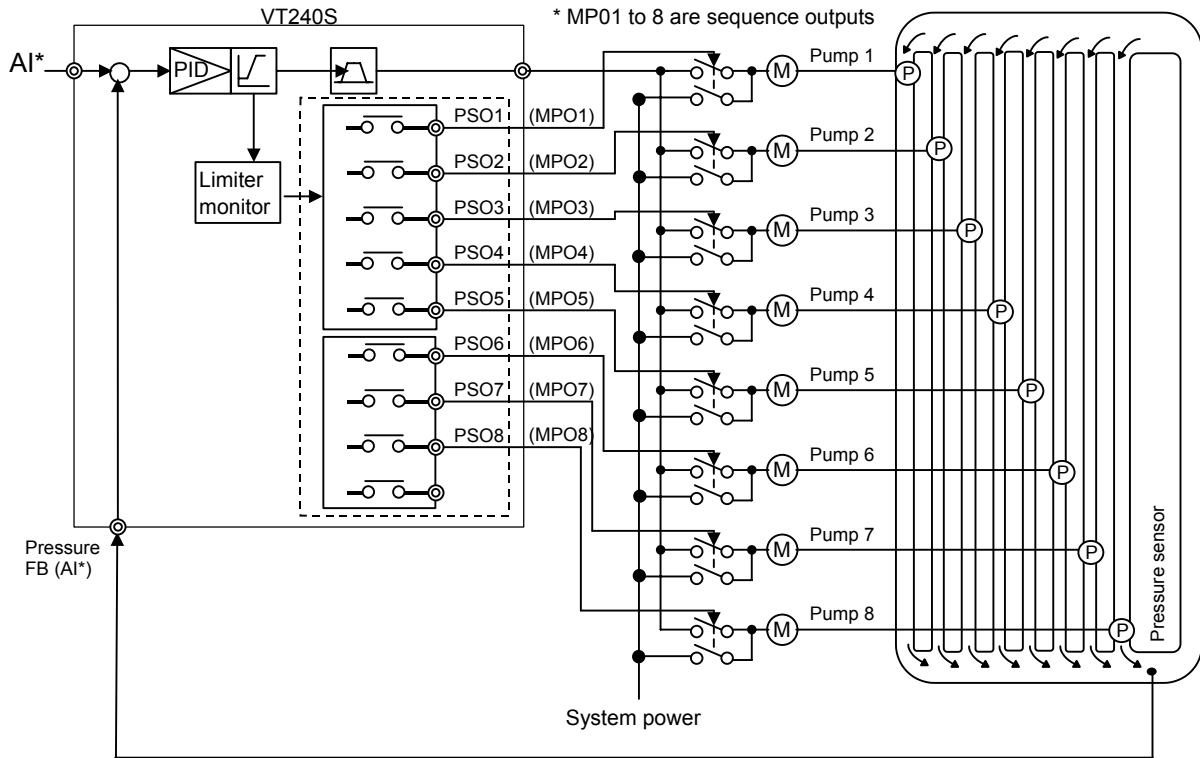

Example of system configuration (When operating eight ON/OFF control pumps)

In the above system, if the INV/commercial changeover interlock is required, an external sequence circuit must be structured. Refer to the following diagram.

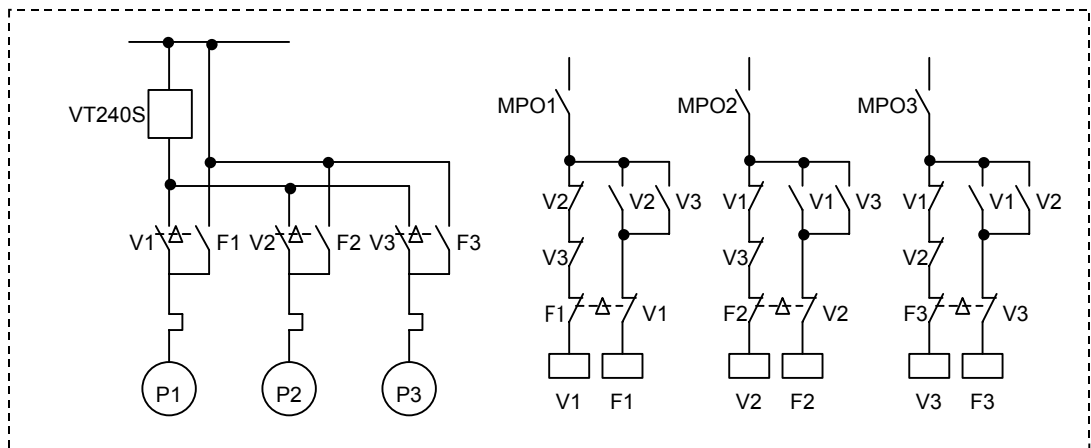

6. Control Functions and Parameter Settings

3) B40-0=8: Main pump with rotation function, 2-contact method

Up to 4 pumps are run in parallel using one VT240S and the VT240S' internal relay output's 8 points. When main pump with rotation is selected, the pump controlled with variable speed is switched to the least operating pump only when all pumps are stopped.

The system configuration is shown below.

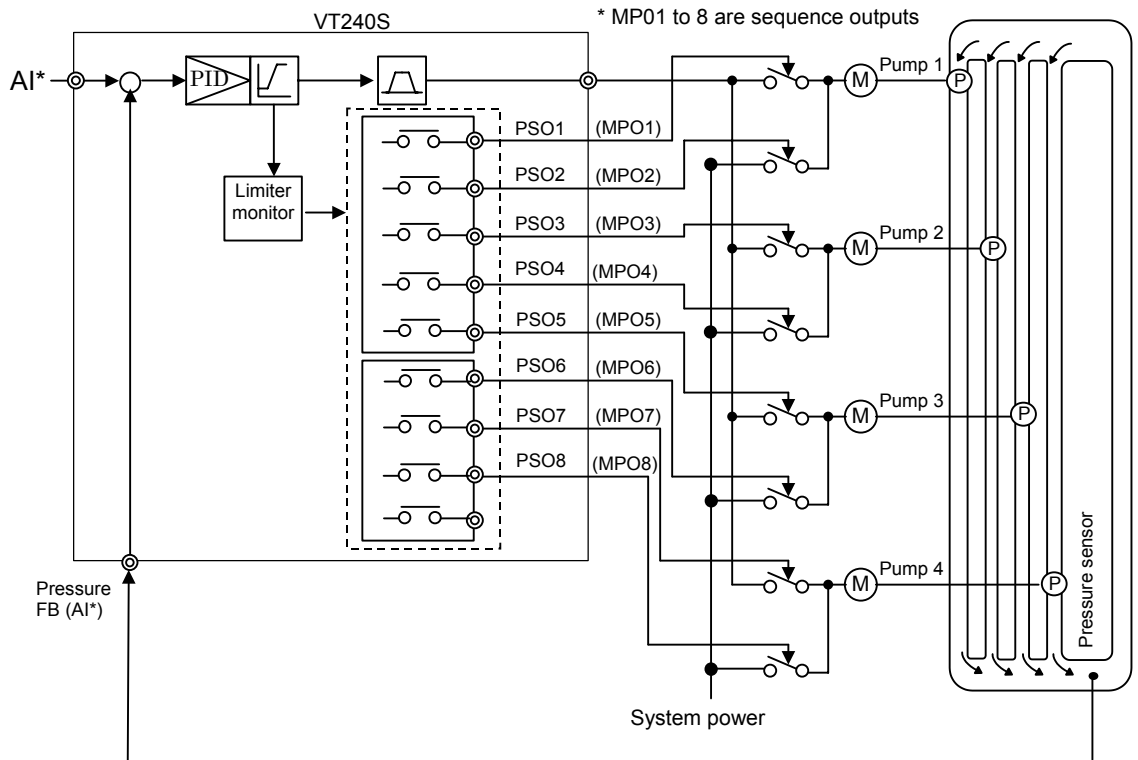

Example of system configuration (When operating four ON/OFF control pumps)

1) Multi-pump control operation

An example of actual operation for the multi-pump control is shown below.

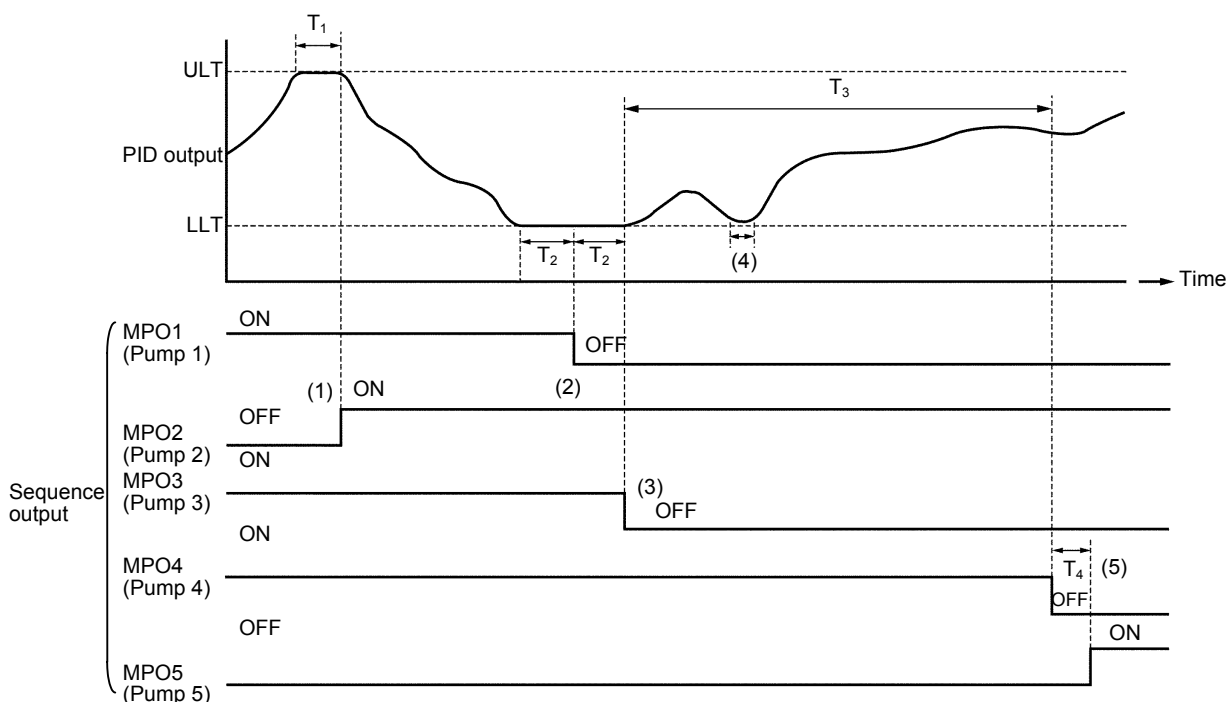

ON/OFF control pump changeover operation (when operating five pumps)

ULT : PID output upper limit value in VT240S (B43-3).

LLT : PID output lower limit value in VT240S (B43-4).

T_1 : Pump start holding time (B44-1)

T_2 : Pump stop holding time (B44-2)

T_3 : Continuous operation limit time (B44-3)

T_4 : Changeover time (B44-4)

The ON/OFF control of multiple pumps is carried out so that the operation time of each pump is equal.

- (1) When the PID output reaches UL and T_1 is passed, the auxiliary pump 2 (MPO2) with the shortest operation time turns ON.
- (2) When the PID output reaches UL and T_2 is passed, the auxiliary pump 1 (MPO1) with the shortest operation time turns OFF.
- (3) Following (2), when the PID output matches LLT for the time of T_2 , the auxiliary pump 3 (MPO3) with the longest operation time turns OFF.
- (4) When the time that the PID output and LLT match does not reach T_2 , the pump OFF control will not be carried out.

- Pump changeover function using continuous operation limit (B44-3)

- (5) When the time that the auxiliary pump's ON/OFF control is not carried out reaches T_3 , the pump 4 (MPO4) with the longest operation time within all of the auxiliary pumps turns OFF, and the pump 5 (MPO5) with the shortest operation time will turn ON after T_4 .

If B44-3 is set to 0, changeover following the continuous operation limit is prohibited. The variable speed control pump will not change even if the continuous operation limit time is exceeded.

6. Control Functions and Parameter Settings

- Main pump rotation function

- (6) When the main pump rotation function is enabled, the variable speed control pump will change to the pump with the shortest operation time of all pump only when all pumps are stopped. When the power is turned ON, pump 1 is always set as the variable speed control pump.
- (7) Only when B40-0=8 (2-contact method) is selected, and the INV drive pump changes to the commercial power drive or vice versa, a dead time is provided to prevent a current back flow from the motor. Both commercial power relay contacts are OFF during the dead time zone. The dead time zone can be set with B44-5.

Other restrictions related to the pump's ON/OFF control are given below.

- (8) When the PID output reaches ULT, the pumps turn ON in order of the shortest running time upwards based on the regulation in (1), however, when all pumps are ON, and the minor fault turns ON as an upper limit alert when the pump operation start maintain time has been exceeded. The minor fault signal is displayed at D05-0 at this time.
- (9) When the PID output reaches LLT, the pumps will sequentially turn OFF from the pump having the longest operation time following the restriction (2) in the previous page. However, if there are no pumps to turn OFF, the VT240S will stop. After the pump stop hold time has passed, the minor fault turns ON as a lower limit alert, and is displayed at D05-0 as the monitor. When the PID output rises and leaves LLT, the VT240S will resume operation.

The FWD and REV LEDs will flicker during the automatic stop operation.

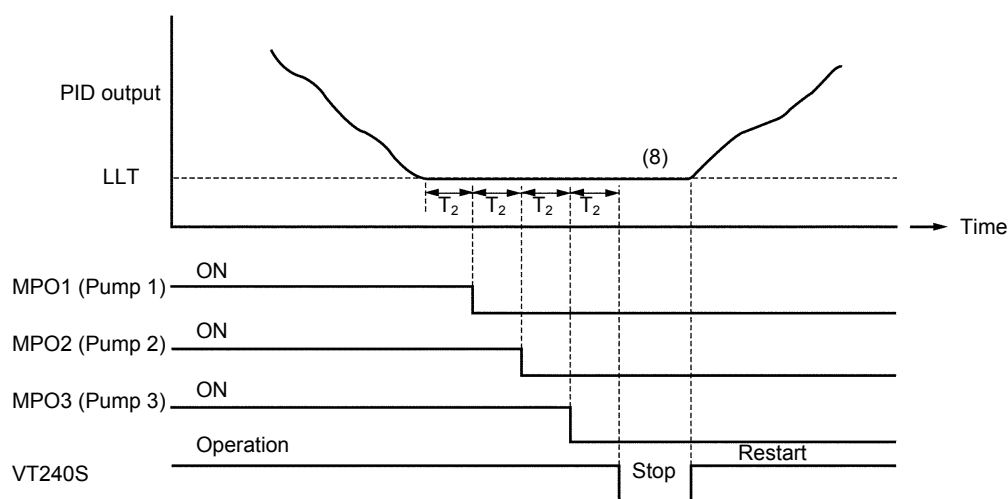

VT240S automatic operation/stop (when there are three ON/OFF control pumps)

- (10) When B43-9: f0=1 (PID operation method = PIDEN + RUN), all commands to the pump are turned OFF at the same time the operation command (RUN) to the inverter is turned OFF.
- (11) When B43-9: f0=2 (PID operation method = PIDEN only), only the INV drive pump stops, even when the operation command (RUN) to the inverter is turned OFF, and the control pump continues to turn ON and OFF with PID output.

6. Control Functions and Parameter Settings

- (12) The following operations are performed when a fault occurs at the inverter.
- When B43-9: f0=1 (PID operation method = PIDEN + RUN):
- The pump ON/OFF commands are maintained provided that the operation command (RUN) ON status is maintained.
The control pump is not turned ON and OFF, and neither is pump switching performed as time passes.
 - When the operation command (RUN) is turned OFF, all commands to the pump are turned OFF.
- When B43-9: f0=2 (PID operation method = PIDEN):
- The pump ON/OFF commands are maintained regardless of whether the operation command (RUN) is turned ON or OFF, and the control pump continues to turn ON and OFF with PID output.
 - All commands to the pump are turned OFF when PIDEN is turned OFF.
- (13) When the inverter's power is turned OFF, the operation time history for each pump will be lost.

2) Preparation for operation

- (1) Set the number of pumps to be ON/OFF controlled in parameter B44-0. One to eight units (four units when B40-1 is 5) can be set. The functions of the output signals MP01 to MP08 for multi-pump control are as follows according to the multi-pump control method.

Pump No. (application)		Output signal
When B40-1 = 3, 4	When B40-1 = 5	
Pump 1	Pump 1 (INV drive)	MP01
Pump 2	Pump 1 (Commercial drive)	MP02
Pump 3	Pump 2 (INV drive)	MP03
Pump 4	Pump 2 (Commercial drive)	MP04
Pump 5	Pump 3 (INV drive)	MP05
Pump 6	Pump 3 (Commercial drive)	MP06
Pump 7	Pump 4 (INV drive)	MP07
Pump 8	Pump 4 (Commercial drive)	MP08

Outputs MP01 to MP08 can be set to a programmable relay output terminal. Using the parameters (C13-2 to 6, C33-0 to 3), set the VT240S standard relay output PS01 to 3, RA-RC, FA-FC and the relay interface option (V24-RY0) in relay outputs PS04 to 7.

The pumps are turned on in the order of pump No. 1 to 8.

The option (V24-RY0) is required to use relay outputs PS04 to 7.

Refer to the Instruction Manual (ST-3477) for details on V24-RY0.

- (2) The PID control function is used with the multi-pump control.
- Refer to the explanation on B43-0 to A for details on setting the PID control related parameters (B43-0 to A), selecting the pressure command input, and selecting the feedback input.
 - Multi-pump control is always carried out in the remote mode (LCL = OFF).
 - The operating command is issued from the external sequence input terminal (RUN).
 - Do not perform operation from R.RUN, F.JOG, R.JOG. If these sequence commands are turned ON, operation is possible as PID, however, the relay outputs for each pump all turn OFF.
 - Turn the sequence input command PIDEN ON to validate PID control.
- (3) Refer to the operation explanation drawing in section (1) and set the parameters B44-1 to 5.
- (4) By using the setting interlock function (C20-0 to 3), the VT240S run/stop can be controlled by the pressure command input (AI1, AI2). In this case, the operation command (RUN) is always ON. Refer to the explanation on C20-0 to 3.

B44-6

Multi-pump control: INV control method at lower limit selection

Select whether to stop the INV or continue operation when the PID output lower limit state continues.

When B44-6=2: Continue is selected, the INV will continue operation without stopping in the "VT240S automatic operation/STOP" state shown in the previous figure.

B45-0~6

Traverse run

Traverse is operation in which the frequency fluctuates with the pattern shown below. This is effective for evenly winding up the thread on a bobbin in a weaving system.

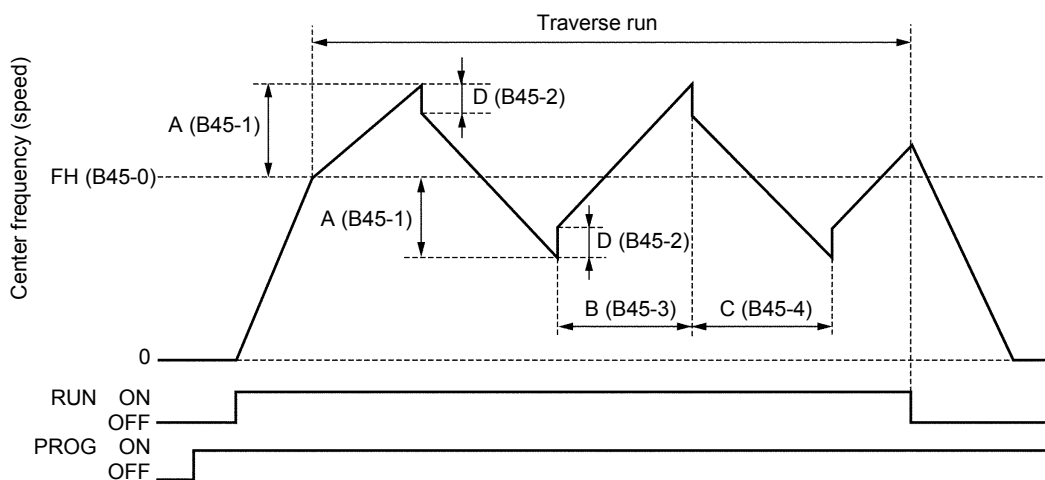

Traverse operation

(1) Traverse run

To carry out traverse run, turn the sequence command PROG ON. (Normal operation will take place if PROG is OFF.)

- 1) If the sequence command RUN or R RUN is turned ON, first, the frequency (speed) will increased as high as the center frequency (speed) in ramp mode (A01-0) at the center frequency (speed), and then traverse run will start.
- 2) When RUN (or R RUN) is turned OFF, the frequency (speed) will decreased to a stop in ramp mode (A01-1) .
- 3) During traverse operation, the conventional ramp, S-shape ramp, overcurrent limit (OCL) and overvoltage limit (OVL) will not function. However, these will function while accelerating or decelerating during start or stop.
- 4) The traverse center frequency (rotation speed) input point can be selected with C02-1.
 - C02-1= 1,2: Analog fixed (C07-4)
 - = 3 : Panel fixed (B45-0)
 - = 4 : Sequence (S0, S1)
 - = 5 : Pulse train input fixed

When using traverse run, set B11-8 to 1 (selection mode setting: binary mode).

If C02-1 is set to 1 or 2, the setting from an external source selected with C07-4 will be the center frequency (speed).

When C02-1 is set to 4, and traverse run is being carried out by turning the PROG command ON, the following operations (2) and (3) will take place when the sequence command S0 and S1 signals are input.

(2) Deviated traverse X, Y operation

The deviated traverse operation shown below takes place with the sequence commands S0 (X) and S1 (Y) when carrying out traverse operation with the PROG command ON.

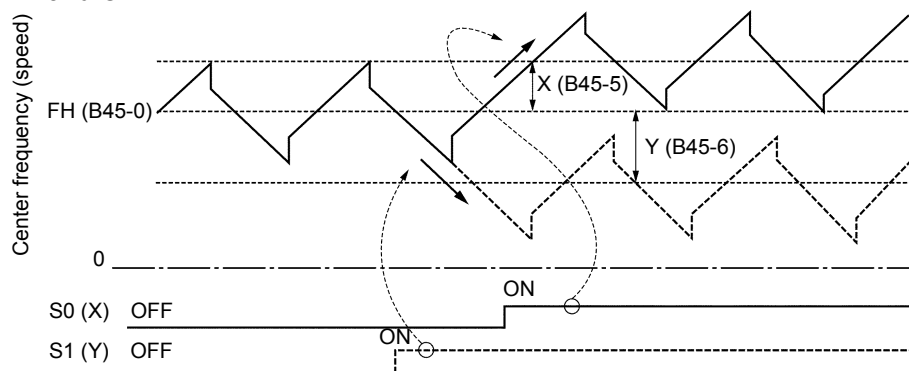

Deviated traverse (X, Y) operation

The center frequency (speed) rises by X (B45-5) only while S0 (X) is ON.
 The center frequency (speed) lowers by Y (B45-6) only while S1 (Y) is ON.
 The rising and lowering timing is the traverse rising and lowering extension operation as shown above.

(3) Changing the center frequency (speed) with settings from an external source

While the PROG command is ON and the traverse operation is taking place, when the sequence commands S0 and S1 both turn ON, the center frequency value (speed) value will be the value set from an external source selected with C07-4.

If only S0 or S1 is ON, the deviated traverse X, Y operation explained in section (2) will take place.

If both S0 and S1 are turned ON, the center frequency (speed) will be the value set from the external terminal. However, the frequency will first return to the center frequency (speed) before rising or lowering to the newly set value. After that, the same operation will take place even when the setting value is changed from an external source.

(4) Precautions for application

- 1) If the parameter No. B45-0 to 6 setting data is changed during traverse operation, the output frequency (speed) will return to the center frequency (speed) once. Then, traverse operation based on the newly set data will take place.
 When returning to the center frequency (speed), the output frequency (speed) will change in ramp mode (A01-0, 1).
- 2) The overcurrent limit (OCL) and overvoltage limit (OVL) functions will not activate during traverse operation, so carefully consider the inverter capacity, motor capacity and traverse related setting values when designing the system.
- 3) The output frequency (speed) is limited between 5.00 and 100.00% during traverse operation.
- 4) When carrying out deviated traverse, take care not to turn the S0 (X) and S1 (Y) commands ON simultaneously.
 If turned ON simultaneously, the (3) center frequency (speed) will change.

B46-0~5

External brake control

The inverter brake can be turned ON and OFF in accordance with the inverter internal sequence. The external brake function contains all types of waiting time settings and an interlock function.

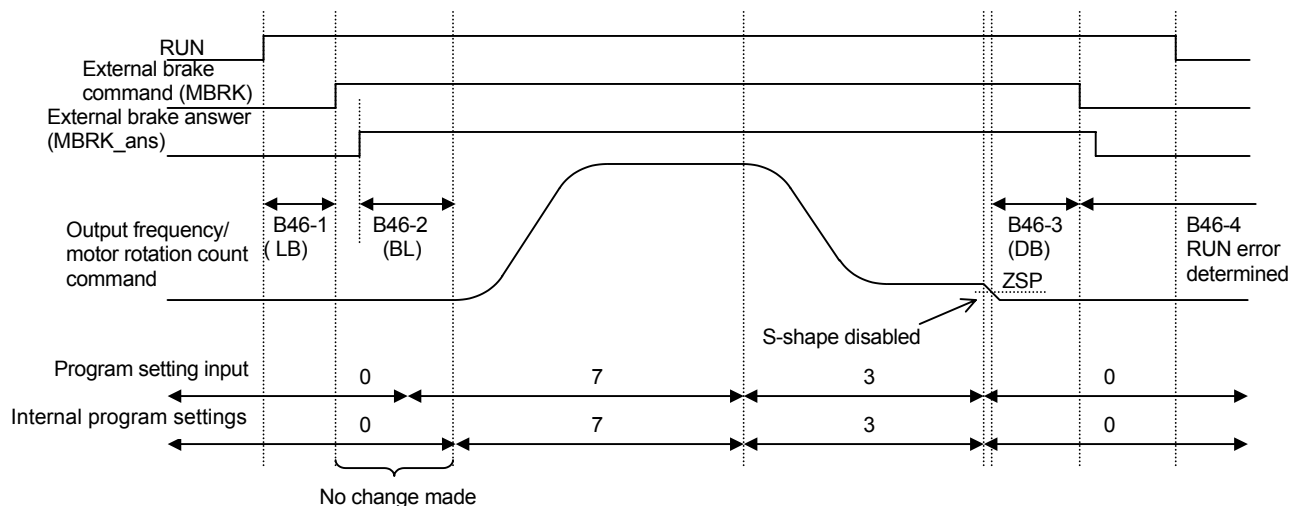

External brake sequence example with program settings used (B46-0 f2=1), and brake answer (B46-5≠0.0)

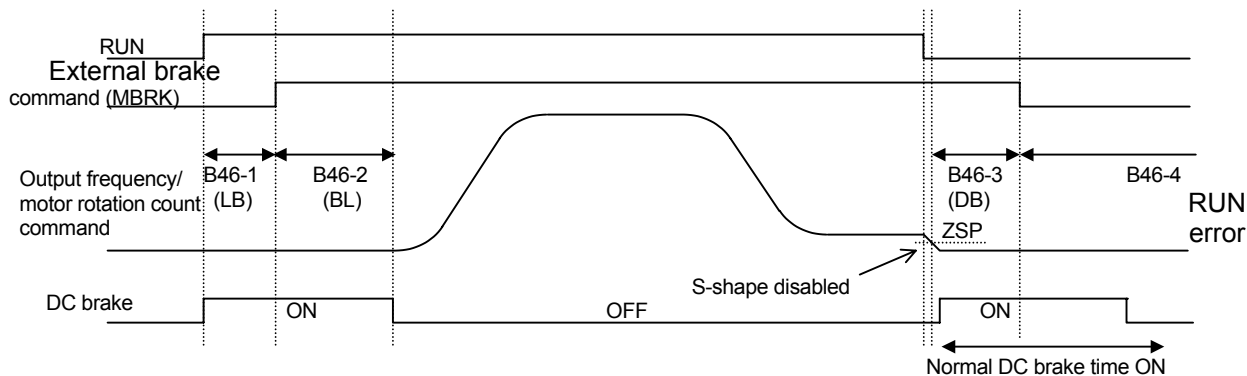

External brake sequence example with DC brake used (B46-0 f2=2), and no brake answer (B46-5=0.0)

(1) External brake selection

- 1) Select the external brake function using B46-0 f_0 .
- 2) Select the IDET based interlock function using B46-0 f_1 . If B46-0 $f_1 = 2$, a breakdown stop occurs at IO-C if IDET is not ON at the point the brake is released (immediately after LB).
- 3) Set the control mode during acceleration waiting time (LB, BL) using B46-0 f_2 .
The normal operation mode is enabled when B46-0 $f_2 = 1$.
The mode changes to DC brake mode when B46-0 $f_2 = 2$.

(2) All types of waiting time

Set the waiting time when using external brake control.

- 1) Use B46-1 to set the waiting time (LB) from RUN until the brake is released.
- 2) Use B46-2 to set the waiting time (BL) from the point the brake is released until acceleration is commenced. When there is a brake answer (B46-5≠0.0sec), set the waiting time from after the brake answer, and if there is no brake answer (B46-5=0), set the waiting time from the point the brake release command is issued.
In the case of the normal operation mode setting, changes are not made to the settings during BL, and the settings prior to BL are used.
- 3) Use B46-3 to set the waiting time (DB) from the point ZSP turns ON until the brake is engaged.

(3) Error determination

The following error determination can be made in cases other than IDET based interlock set at B46-0 [1].

- 1) RUN error determination when engaging brake
In the case where RUN does not turn OFF in the time set at B46-4 from the time the brake is engaged, a breakdown stop occurs at the end controller due to an external brake RUN error (IO-D). Set to 0.0 sec to turn the RUN error determination OFF.
- 2) Brake answer error determination
In the case where (MBRK) brake command and (MBRK_ans) brake answer do not match above the time set at B46-5, an external brake answer error (IO-E) occurs as an external brake breakdown, and a breakdown stop occurs. Set to 0.0 sec to turn the brake answer error determination OFF.

(4) S-shape cushion pass function

If the S-shape characteristics (B10-4) have been set, the S-shape characteristics are applied when engaging the external brake, and therefore there are cases when the frequency does not drop immediately. In order to avoid this, set B10-6=2 or 3 to disable the S-shape characteristics when stopping.

B10-6=2: S-shape passed when program setting is 0.

B10-6=3: S-shape passed when RUN command is OFF.

B47-0~6

Simple ASR control

If the speed detection option preset board (V23-DN1 or DN2) is installed when V/f control is selected (C30-0=1, 2), simple ASR can be used. Simple ASR involves comparing the frequency command value and motor rotation count (frequency calculation value), and controlling the slippage frequency so that the frequency command matches the motor rotation count.

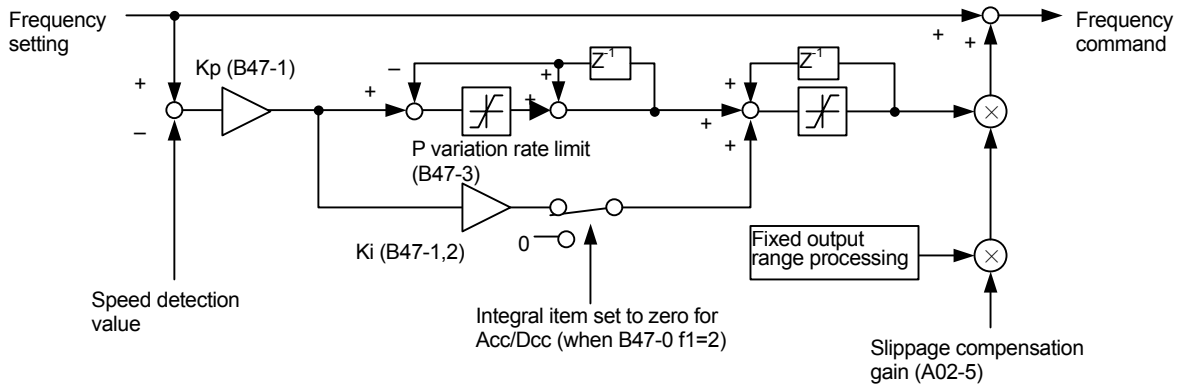

Simple ASR control block diagram

- (1) Simple ASR control is performed when B47-0 $f_0 = 2$.
- (2) The integral operation is stopped when accelerating if B47-0 $f_1 = 2$. The overshoot when the frequency is attained can be curtailed.
- (3) Set the proportional gain is set at B47-1. Increase the proportional gain to raise the motor count compliance, however, motor hunting will occur if increased too much.
- (4) Set the integral time constant at B47-2. Shorten the integral time constant to raise the rotation count compliance when the motor has a load, however, the overshoot will increase when the frequency is attained.
- (5) Set the proportional variation rate control at B47-3. Set a small value in order to avoid excess proportional rotational variations.
- (6) Set the compensating torque limiter at B47-4. Simple ASR output is output in a simple torque form. Set a small value for the compensating torque limiter to avoid overcompensating.
- (7) Set the simple ASR pole count at B47-5.
- (8) Set the simple ASR speed detection unit pulse count a B47-6.
- (9) The pick-up operation is required when restarting operation while the motor is rotating. This differs from vector control in that magnetic flux control is not performed. In order to pick up, 500msec finishing time is required in addition to pick-up standby time (C21-2).

(Note 1) Simple ASR differs from vector control in that torque limit control is not possible.

(Note 2) The speed detection value displays at D00-5.

B50-0
~**B59-3**

Pattern run function

The frequency (speed), run direction and time can be changed automatically with the pattern run function.

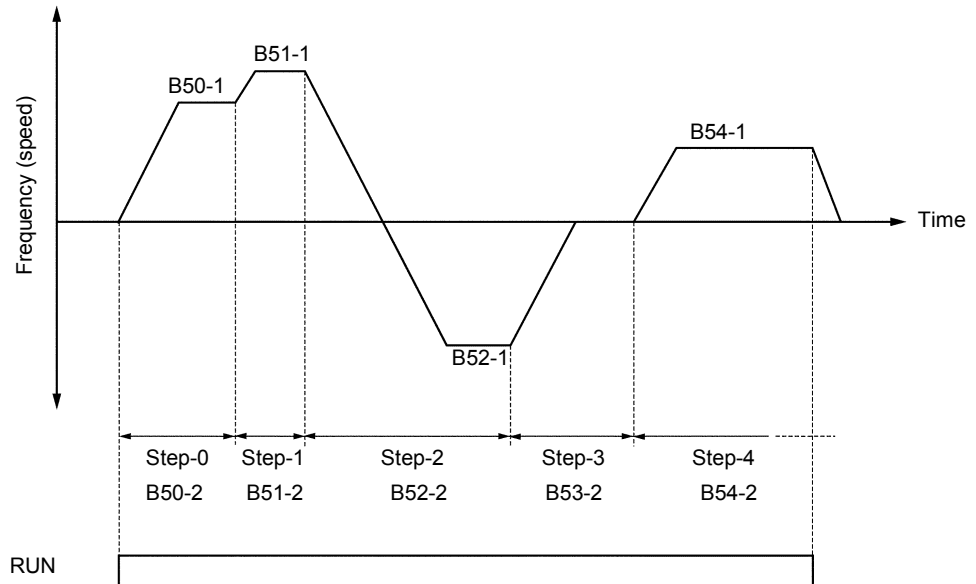

- (1) A max. of ten patterns can be set. Program in the B50-B59 blocks as shown below. The speed setting input point is selected with C02-0 = 4 (sequence). n is the step No. from 0 to 9.

B5n-0: Run mode
 = 0: Stop
 = 1: Forward run
 = 2: Reverse run
 = 3: Final step (set when repeating before B59)

B5n-1: Run frequency (speed) [%]

B5n-2: Run time [sec.]

B5n-3: Return destination step
 = 0 ~ 8
 (Set the No. of the step to be executed next when B5n-0 = 3.)

6. Control Functions and Parameter Settings

- (2) The sequence command functions will be as shown below during pattern running.

RUN: Pattern run starts when this turns ON, and operation starts from the run frequency (speed) and operation time applied when the operation was previously stopped. The inverter will stop when this is turned OFF.

(Note 1) The pattern running operates with the remote mode (LCL OFF).

(Note 2) The R.RUN, F.JOG, and R.JOG commands are invalid during pattern running.

S0: Proceeds to the next step at the edge from OFF to ON. (Skip)

By turning this signal ON/OFF with S1 ON (hold), the step can be proceeded in synchronization with the peripheral machine regardless of the internal timer.

S1: The internal timer operation will stop when ON. (Hold).

Use this to pause the pattern run.

S2: When this is turned ON, the operation will be reset to step 0.

The S0 and S1 functions are valid only when RUN is ON.

The S2 function is not related to the ON/OFF setting of RUN, and is valid at all times.

When the mode is changed to the local mode (LCL ON), this will be reset to step 0.

During pattern run, set B11-8 to 1 (selection mode setting: binary mode).

- (3) When using pattern run, the sequence status output (D04-4) ACC and DCC functions will change as shown below.

ACC: Turns ON when the last step of the pattern run is being executed. (EOS)

DCC: Operates with the reverse logic of the above ACC. (EOS)

**B60-0
~B76-6**

Spinning frame function

This function is used to perform spinning pattern operation. This differs from the previous pattern operation in that acceleration/deceleration is performed in a straight line cushion (auto setting) until the setting point is reached. Set the parameter selection B60-0 f_0 to 2 (selection) to enable the spinning frame function.

(Note 1) The spinning frame function is a V/f control function. Select control mode selection C30-0 $f_0=1$.

- (1) Up to four Speed-Time Patterns (STP) can be set up to a maximum of fifteen steps. Each step is set at the target frequency and time taken to attain that frequency from the previous step. Set each STP end step number at B60-1~4. The time unit can be set at B60-6. This settings is valid for the STP time settings (B63-0~B64-6, B67-0~B68-6, B71-0~B72-6, B75-0~B76-6) and Doff-End alarm time (B60-5). The frequency and time setting in each step of STP can be changed. Note that changes made to the STP settings during the step will be reflected when the step is updated.

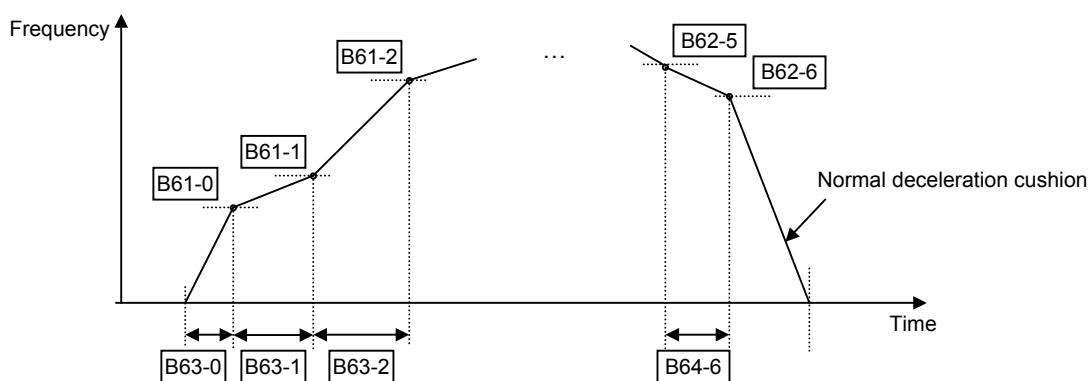

When STP0 is selected, and B60-1=14

- (2) STP switching can be performed using the external terminal. There are four Speed-Time Patterns (STP), and they are selected at external terminal input (S0, S1, S2, S3). Use parameters B11-8 to select the binary mode and direct input mode.

Binary mode (B11-8=*1)

Sequence command				Selection STP No.
S3	S2	S1	S0	
*	*	OFF	OFF	STP0
*	*	OFF	ON	STP1
*	*	ON	OFF	STP2
*	*	ON	ON	STP3

Direct input mode (B11-8=*2)

Sequence command				Selection STP No.
S3	S2	S1	S0	
OFF	OFF	OFF	OFF	Previous value
OFF	OFF	OFF	ON	STP0
OFF	OFF	ON	OFF	STP1
OFF	ON	OFF	OFF	STP2
ON	OFF	OFF	OFF	STP3

(Note 2) STP switching cannot be performed during operation. If STP switching is performed during operation, the current pattern is maintained, and switching is performed after pattern operation is complete.

(3) Speed-Time Pattern (STP) operation

- 1) STP operation is performed when the sequence command RUN is issued. (F.JOG, R.JOG inching operation cannot be performed.) Operation is commenced from the selected STP Step 0.
- 2) The method of stopping after the pattern ends can be selected with the function selection B60-0 f1.

B60-0: f1 = 1 (automatic stop)

- The inverter automatically stops after the last step is finished. Either normal deceleration ramp or coast to stop can be selected with the operation stop method (C00-1).

B60-0: f1 = 2 (FRQ_SP operation)

- After the last step is finished, the inverter shifts to special frequency (FRQ_SP) at the normal deceleration ramp, and continuous running. Operation at FRQ_SP continuous until the Run command turns OFF.
- When the RUN command turns OFF, the inverter stops with the normal deceleration ramp or coast to stop depending on the operation stop method (C00-1).
- The special frequency (FRQ_SP) can be set with parameter B60-9.

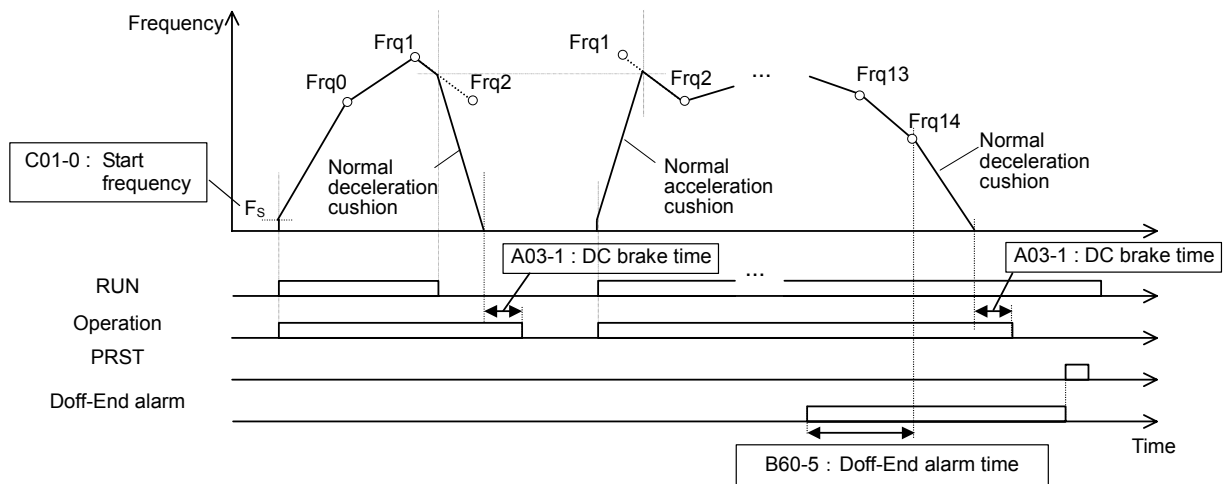

For automatic stop selection (B60-0=12)

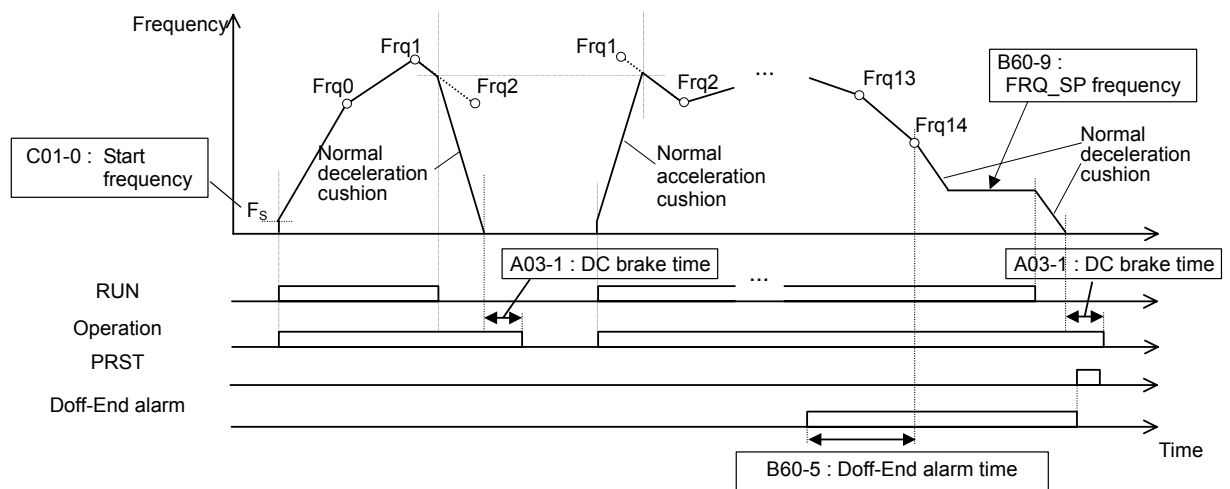

For FRQ_SP operation selection (B60-0=22)

- 3) If the operation command is turned OFF during STP operation, normal deceleration cushion or free-run stop is performed. When restarting operation, after accelerating with the normal acceleration cushion until the previous stop frequency is reached, STP operation is restarted from the previous stop step and operation time.
- 4) When operation is stopped due to a power outage, after resuming the power, pattern operation is restarted from the frequency and time when the stop occurred.

(4) Pattern operation can be reset by the external terminal input (PRST).

Select the input terminal by selecting sequence input (C03-9). A stop occurs when the PRST is turned ON during STP operation. Operation is commenced from STEP0 when restarting operation.

The method for stopping at pattern reset can be selected with function selection B60-0 f1.

B60-0: f1 = 1 (automatic stop)

- The inverter will automatically stop if PRST is turned ON during STP operation. Either normal deceleration ramp or coast to stop can be selected with the operation stop method (C00-1).

B60-0: f1 = 2 (FRQ_SP operation)

- If PRST is turned ON during STP operation, the inverter will shift to special frequency (FRQ_SP) at the normal deceleration ramp, and will continue running. Operation at FRQ_SP continuous until the RUN command turns OFF.
- When the RUN command turns OFF, the inverter stops with the normal deceleration ramp or coast to stop depending on the operation stop method (C00-1).

(5) A Doff-End alarm is output at the final stage of the pattern.

By setting the Doff-End alarm time (B60-5), the Doff-End alarm is output from the point after completion of the final step to the point going back the set time.

The Doff-End alarm remains ON even after the pattern is completed. The Doff-End alarm is cleared by the PRST.

Select the output terminal for the Doff-End alarm with the output selection (C13-2 to 6, C33-0 to 3).

(Note 3) Even if the Doff-End alarm is ON, when the RUN signal is input, the Doff-End alarm will turn OFF and operation will start from Step 0.

(Note 4) Normal acceleration/deceleration cushion switching can be performed using CSEL.

The Doff-End alarm time and average frequency calculation is always performed with cushion 1 even if cushion 2 is selected.

(6) Spindle average frequency display (D13-3)

The currently selected STP average frequency is displayed at monitor D13-3. The average frequency is obtained using the following formulae.

$$S_0 = \frac{(F_s[\%] + F_0[\%]) \times T_0[\text{sec}]}{2}$$

$$S_n = \frac{(F_{n-1}[\%] + F_n[\%]) \times T_n[\text{sec}]}{2} \quad (n: \text{Step no.})$$

$$S_D = \frac{F_n[\%] \times T_D[\text{sec}]}{2}$$

1) Operation stop method (C00-1) =1: Free-run stop

$$\text{Average frequency} = \frac{S_0 + S_1 + \dots + S_n + S_D}{T_0[\text{sec}] + T_1[\text{sec}] + \dots + T_n[\text{sec}] + T_D[\text{sec}]} \times F_{\text{MAX}}[\text{Hz}]$$

2) Operation stop method (C00-1) =2: Deceleration stop

$$\text{Average frequency} = \frac{S_0 + S_1 + \dots + S_n}{T_0[\text{sec}] + T_1[\text{sec}] + \dots + T_n[\text{sec}]} \times F_{\text{MAX}}[\text{Hz}]$$

(Note 5) At the time of FRQ_SP operation, average frequency switches to FRQ_SP.

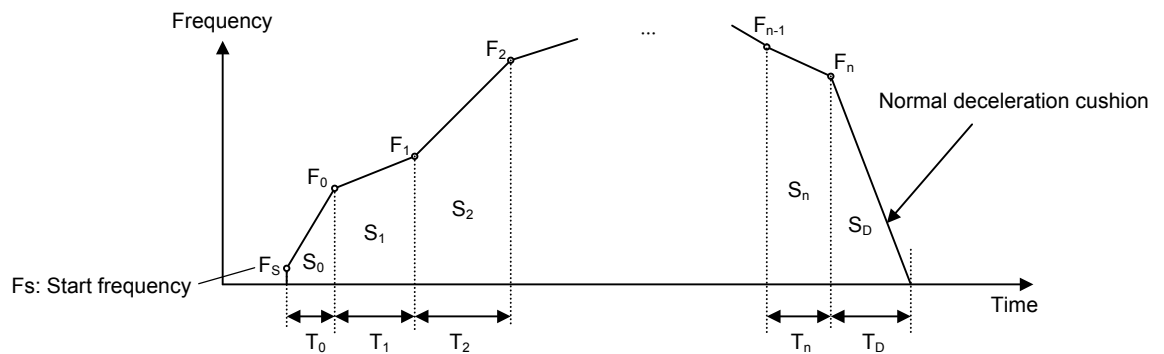

(7) Hank count display (D13-4)

The current Hank count displays at monitor D13-3. The Hank count is obtained using the following formula.

$$H_C = F_{\text{AVG}} \times T_{\text{RUN}} \times \frac{1}{840} \times \text{Gain}$$

F_{AVG} [Hz]: Average frequency T_{RUN} [sec]: Operation time
 840: 1 Hank = 840 yard

It is necessary to set the gain (B60-7, B60-8) in order to display the Hank count correctly. The gain is obtained using the following formula.

$$\text{Gain} = 2p \times R_s \times \frac{2}{\text{Pole}} \times \frac{1}{G_R} \times K_C$$

R_s : Spindle radius [yard] Pole: Motor pole count
 G_R : Gear ratio = $\frac{N_2}{N_1}$ (N_1 : Motor gear count, N_2 : Spindle gear count)
 K_C : Compensation coefficient (Compensate slippage etc.)

(Note 6) The Hank count calculation is continued during operation, however, is reset to zero when the power is turned OFF.

6-6-4 Explanation of Block-C parameter functions

C00-0 Run command method

Set the run command method for the remote operation mode (when "LCL" LED on operation panel is OFF). Set the sequence command, F.RUN, R.RUN and HOLD with C03-0, C03-2 and C03-5.

= 1: F·RUN, R·RUN

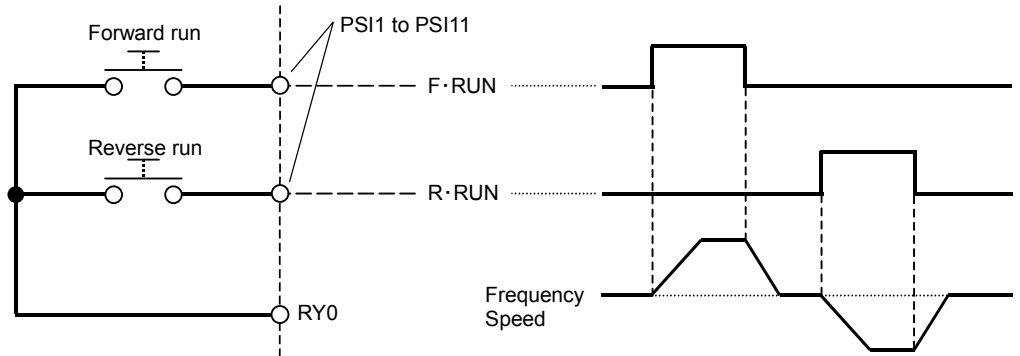

= 2: RUN, REV

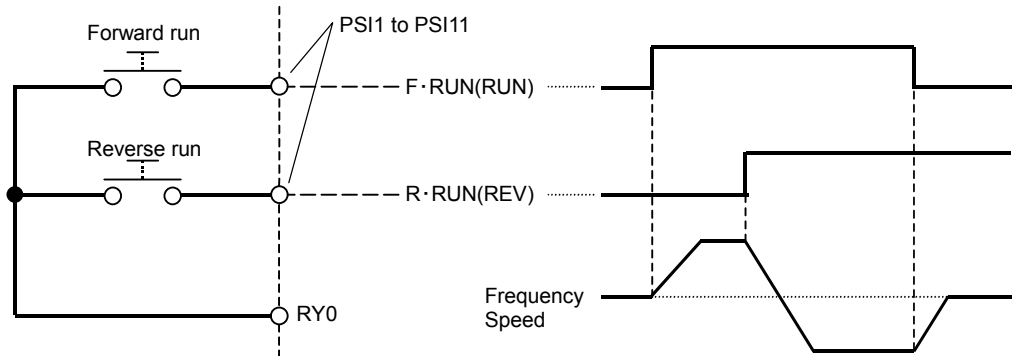

= 3: Self hold

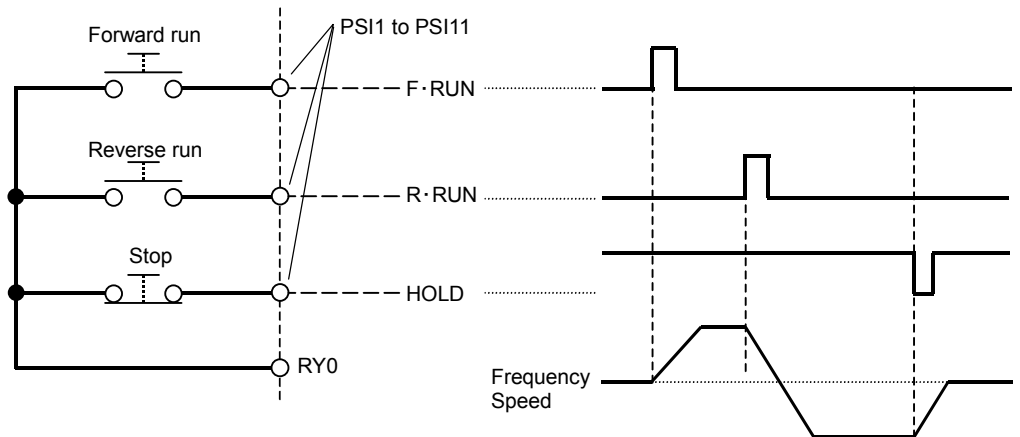

(Note) PSI8 to 11 can be used only when the relay interface option is mounted.

C00-1
C00-2

Run/stop methods

Jog stop method

- = 1: Coast to stop
- = 2: Deceleration stop

Coast to stop refers to stopping by turning the output OFF simultaneously with the stop command (F·RUN and R·RUN OFF).

Deceleration stop refers to stopping by decelerating to the stopping frequency with the ramp down after the stop command, and then applying the DC-brake to stop.

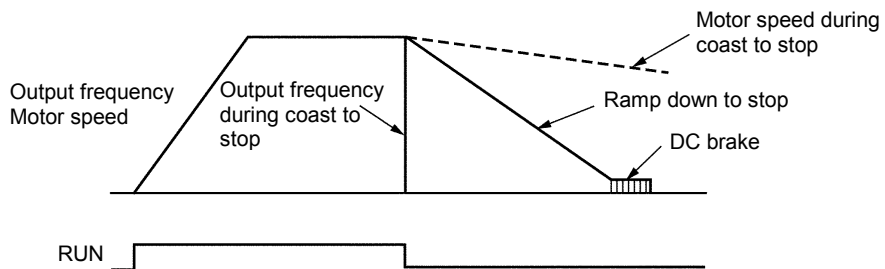

(Note) When not using the pick-up function to restart after coast to stop, confirm that the motor is stopped. When not using the pickup function, if the inverter is started while the motor is rotating, the inverter may trip.

C00-3

Emergency stop (EMS) input logic

Set the input logic of the emergency stop sequence input signal EMS.

- = 1: Close to stop (when a contact is connected)
- = 2: Open to stop (when b contact is connected)

Select the EMS signal input terminal from the control PCB terminal block PSI to 11, and set PSI1 to PSI11 with C03-1.

(Note) PSI8 to 11 can be used only when the relay interface option is mounted.

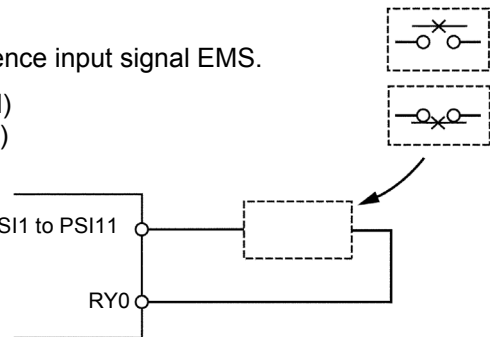

C00-4

Emergency stop (EMS) mode

Set the method of stopping when the emergency stop sequence input EMS turns ON.

- = 1: Coast to stop, without fault output
- = 2: Coast to stop, with fault output (When the EMS signal turns ON, the output will be shut off, and FLT will be output.)
- = 3: Ramp down to stop (without fault output)

C00-5

Control source switchover method (J1 setting)

J1 setting =1: OFF =2: ON

Select whether to use the sequence input signals from the control PCB terminal block in the local operation mode (when "LCL" LED on operation panel is ON).

Refer to section 5-5 for details.

C00-6

Control source switchover method (J2 setting)

J2 setting =1: OFF =2: ON

Select the auxiliary command input when the COP command is ON.

Refer to section 5-5 for details.

C00-7

Run contact output condition selection

The conditions for turning the sequence RUN output ON are set.

= 1: ON at pre-excitation (EXC)

= 2: OFF at pre-excitation (EXC)

C02-0~8

Various setting input selection

Refer to section 5-9 for details.

C03-0~F

Sequence input terminal function – 1

C04-0~F

Sequence input terminal function – 2

C05-0~7

Sequence input terminal function – 3

C06-0~A

Sequence input terminal function – 4

Refer to section 5-3, 5-6 for details. Refer to the explanation for B06-0 to 6 (ratio interlock bias increase/decrease function) for details on C03-A and C04-9 to A.

C07-0~A

Analog input terminal function

Refer to section 5-7 for details.

C08-0

Auto start (To F·RUN/R·RUN)

= 1: OFF (runs with the run command ON after pre-charging)

= 2: ON without pick-up

If the run command is ON when the power is turned on, run will start after the inverter is charged.

(Note 1) Pick-up is not executed with this setting, so if the motor is rotating when the power is turned ON, the inverter operation could trip.

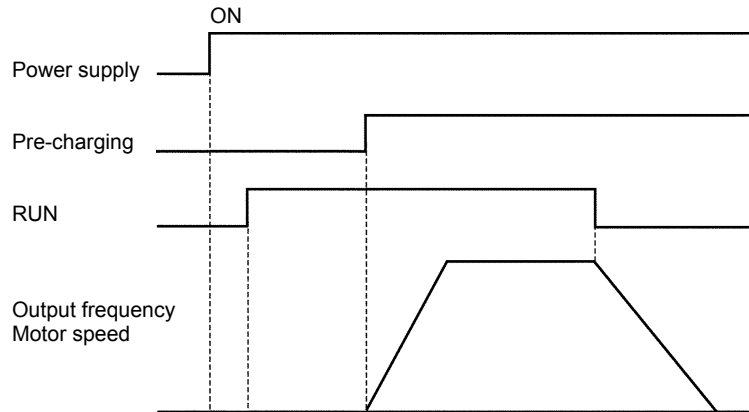

= 3: ON with pick-up

If the run command turns ON when the power turns ON, pick-up will start when the inverter charging is completed, and then operation will start.

Set this when using momentary restart.

(Note 2) The speed can be detected with the IM vector control with sensor and PM motor control (C30-0 f_0 = 3, 4). As pickup operation is not carried out, set C08-0 to 2.

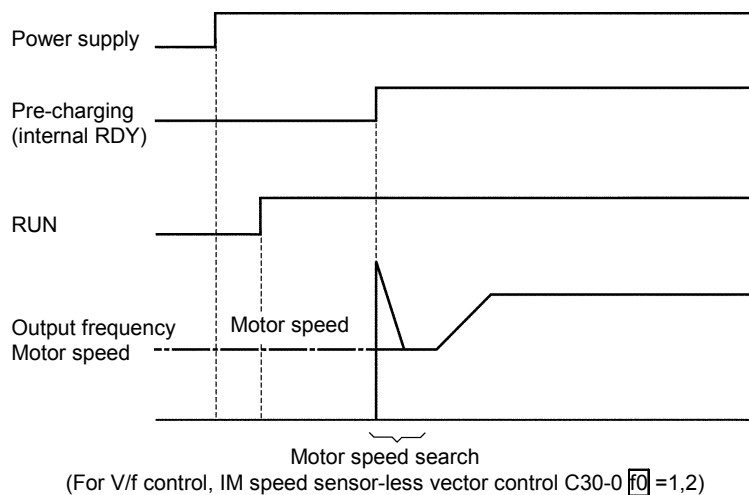

(Note 3) If auto start (C08-0 = 2, 3) is used, undervoltage fault will not be detected.

C09-0

Parameter protection

Set this parameter to prevent unintentional operations from operation panel. Changing of the data can be protected per function group with the setting value as shown below.

value	Block A	Block B, C			
		Basic	Extn.	S/W	H/W
1	○	○	○	○	○
2	×	×	×	×	×
3	○	×	×	×	×
4	○	×	○	×	×
5	○	×	○	○	×
6	○	○	○	○	○
7 ~ 8	×	×	×	×	×
9	○	○	○	○	○

○ : Unprotected (changeable)
 × : Protected (unchangeable)

- (Note 1) Set 2 to prohibit all changes.
- (Note 2) Set 1 to allow all changes. The 9 setting is for maker maintenance, so do not set it.
- (Note 3) When using the password number function (when C28-0 is set to 2), this parameter will also be locked. Set U00-1 to the value set with C28-1 to unlock the protection.

C09-1



Operation panel lock



This setting protects the operation panel FWD, REV and STOP key operations.

- = 1: All operation possible
- = 2: All operation prohibited (Note, the motor will stop when the STOP key is pressed for two seconds)
- = 3: Only STOP key can be operated.

C09-2

LCL switchover protection

= 1: LCL mode switchover ( +  keys) during running disabled

= 2: LCL mode switchover ( +  keys) during running enabled

(Note) When switching from the local mode to the remote mode, if the terminal block RUN, R.RUN, F.JOG or R.JOG is ON, the mode will not switch even if operation is stopped.

C09-3

Reverse run sequence (R·RUN) prohibit

C09-4

Reverse run jogging sequence (R·JOG) prohibit

= 1: Enable = 2: Prohibit

Set this to prevent unintentional reverse run operation.

When set to "2", the sequence input "R RUN(R JOG)" operation command will be disabled. Note that if the reverse run setting (negative value) is input into the speed setting during "F·RUN(F JOG)" operation, reverse run will start.

C09-5

Reverse run during ACR mode prohibit

= 1: Enable = 2: Prohibit

Set this to prevent unintentional reverse run operation.

When set to "2", reverse run during ACR operation will be prohibited.

The reverse run speed will be limited to approx. 1% if reverse run is started.

This setting is ignored in the V/f mode.

C09-6

Fault history buffer clear

The fault history details can be cleared by setting the value to 1 and then pressing  key.

This setting will not be registered in the internal memory. Thus, this parameter must be set each time.

Nothing will occur if set to a value other than 1.

Use this before handing the unit over to the final user.

(Note) The setting values exceeding 2000 are codes for maker maintenance, so do not set.

C09-7

Default value load

All values per function group are changed to the default values.

9: All default values load (Excluding the maker maintenance parameters)

10: Parameter A

11: Parameters B, C basic functions

12: Parameters B, C extended functions

13: Parameter B software option function

Parameter C hardware option function

14: Parameters B basic functions

15: Parameters B extended functions

16: Parameter B software option function

17: Parameters C basic functions

18: Parameters C extended functions

19: Parameter C hardware option function

Nothing will occur when values other than the above are set.

This parameter setting value will not be registered in the internal memory.

(Note) The setting values exceeding 2000 are codes for maker maintenance, so do not set.
If set, the following inverter operation may be abnormal.

C10-0~7

Custom parameter register

Refer to section 4-4 for details on operating these parameters.

C12-0

AI1 terminal input mode selection

C12-4

AI2 terminal input mode selection

Select the input mode for the AI1 and AI2 terminals.

- C12-0, 4 = 1 : Voltage input
- = 2 : Current input

Refer to section 5-7 for details on using the analog input terminal.

C12-1

AI1 voltage input mode selection

C12-5

AI2 voltage input mode selection

When the AI1 and AI2 terminal input mode is set to voltage input (C12-0, 4 = 1), set the full scale of these terminal input signals.

- C12-1, 5 = 1 : 0 to 10V
- = 2 : 0 to 5V
- = 3 : 1 to 5V

As an example, the relation of the voltage input value and speed setting value when the AI1 and AI2 terminal input function is used for the speed setting is shown below. Refer to Table 5-7-1 for the relation of the analog input value and each setting value when using the input terminal for a function other than speed setting.

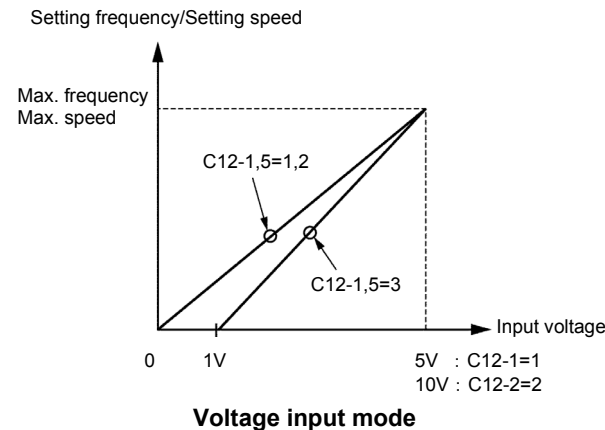

C12-2

AI1 current input mode selection

C12-6

AI2 current input mode selection

When the AI1 and AI2 terminal input mode is set to current input (C12-0, 4 = 2), set the full scale of these terminal input signals.

- C12-2, 6 = 1 : 4 to 20mA
- = 2 : 0 to 20mA

As an example, the relation of the current input value and speed setting value when the AI1 and AI2 terminal input function is used for the speed setting is shown below. Refer to Table 5-7-1 for the relation of the analog input value and each setting value when using the input terminal for a function other than speed setting.

6. Control Functions and Parameter Settings

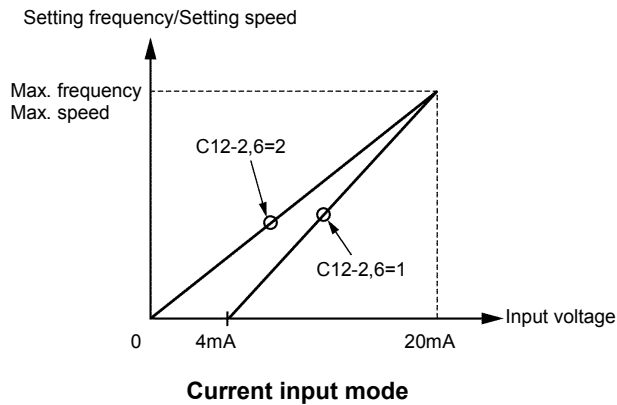

C12-8

AI3 terminal input mode selection

C12-9

AI3 input gain

Set the full scale of the AI3 terminal analog input signal with C12-8.

- C12-8 = 1 : -10V to +10V
- = 2 : -5V to +5V
- = 3 : +1V to +5V

A multiplication gain can be applied on the AI3 terminal input value with C12-9.

As an example, the relation of the voltage input value and speed setting value when the AI3 terminal input function is used for the speed setting is shown below. Refer to Table 5-7-1 for the relation of the analog input value and each setting value when using the input terminal for a function other than speed setting.

Refer to section 5-7 for details on using the analog input terminals.

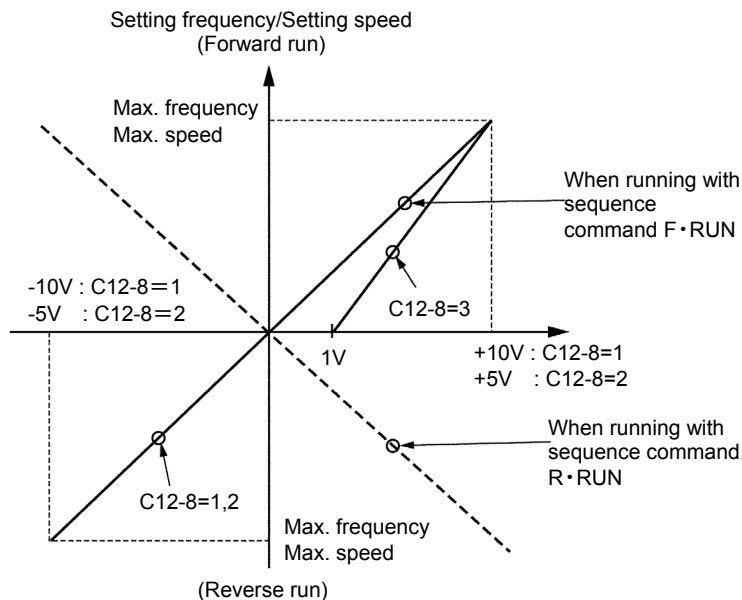

C12-3
C12-7
C12-A

Filter time constant for AI1 input

Filter time constant for AI2 input

Filter time constant for AI3 input

The filter time constant for the input value of the AI1, AI2 and AI3 terminals can be set. Fluctuation of the setting value caused by input signal noise or chattering, etc., can be suppressed by increasing the time constant.

C12-B

Program setting filter

The program speed and ramp setting are set with the sequence commands S0 to SE, but chattering could occur when these input terminals are changed. In order to avoid this, batch filter processing is performed for S0 to SE.

The input signal is validated when the S0 to SE input terminals obtain the same value for longer than the set time, so the program settings will not change for the time set in C12-B after the input is changed.

Set C12-B to a time longer than that at which chattering could occur, and lower than the setting delay tolerance time.

C12-C
C12-D
C12-E
C12-F

Pulse train input : 0% setting frequency (F1)

Pulse train input : 100% setting frequency (F2)

Pulse train input frequency LPF time constant

Pulse train input judgment time

Refer to section 5-7-3 for details related to the pulse train input function.

C13-0
C13-1

A01 terminal output

A02 terminal output

The inverter's internal parameters can be output from the control PCB analog output terminals A01 and A02.

The parameters corresponding to the C13-0, 1 setting values and the full scale of those output signals is shown below. The output voltage and current values are output as a percentage of the full scale. Refer to section 5-8 for details on using the analog output terminals.

Value	Parameter	Full scale
0	Output frequency	Max. frequency
1	Setting frequency Setting speed	Max. frequency Max. speed
2	Ramp output	Max. frequency Max. speed
3	Output current (Motor)	Motor rated current × 2
4	Output current (Drive)	Drive rated current × 2
5	Output voltage	Motor rated voltage
6	Motor output power	(Motor rated voltage × Motor rated current) × 2
7	DC voltage	200V Series : 300V 400V Series : 600V
8	OLT monitor (unit protection)	100%
9	Heat sink temperature	100°C
10	Motor speed	Max. speed

Value	Parameter	Full scale
11	Torque current	Motor rated current × 2
12	Excitation current	Motor rated current × 2
13	Actual motor rotation speed	Max. speed
14	Namp output	Rated torque
15	OLT monitor (motor protection)	100%
16	Built-in PLC output 1	1000h
17	Built-in PLC output 2	1000h
18	Built-in PLC output 3	1000h
19	Built-in PLC output 4	1000h
20	DM1 for maker maintenance	1000h
21	DM2 for maker maintenance	1000h

(Note 1) DM1 and DM2 for maker maintenance are to be used only by the maker for maintenance. The user must not set C13-0, 1 to 20 or 21.

C13-2
C13-3~5
C13-6

RA-RC output parameters
PSO1, 2, 3 output parameters
FA-FC output parameters

Refer to section 5-6-2 for details.

C13-7~A

Built-in PLC input selection 1~4

Refer to section 6-11 for details.

C13-B
C13-C
C13-D
C13-E
C13-F

Pulse train output function
Pulse frequency at 0%
Pulse frequency at maximum frequency/speed
Pulse train output parameter selection
Output parameter absolute value calculation selection

Refer to section 5-8-3 for details on the pulse train output function.

C14-7, 8
C14-0, 1
C14-3, 4
C14-5, 6

A01, A02 output method selection
A01, A02 output gain
A01, A02 output offset (Voltage)
A01, A02 output offset (Current)

The block diagram for the control PCB analog outputs A01 and A02 is shown below.

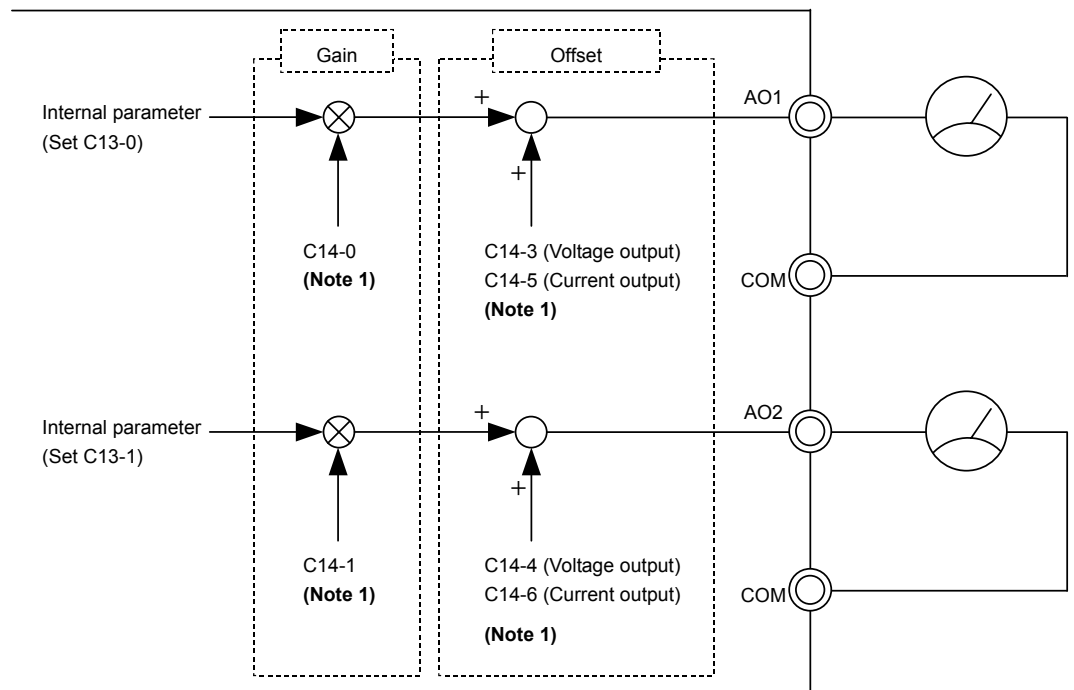

6. Control Functions and Parameter Settings

(Note 1) The maximum output voltage for the A01 and A02 output is approx. 11V. Thus, even if the gain or offset are set to a large value, a voltage higher than this maximum level will not be output.

Set the A01, A02 output method with C14-7, 8.

- C14-7, 8 = 1: Voltage output 0V to 10V
- = 2: Voltage output 0V to 10V (with 5V offset)
- = 3: Current output 4mA to 20mA

When using A01, A02 for the voltage output (C14-7, 8 = 1 or 2), connect the control PCB A01/A02 L bit (W3, W4) to the voltage mode side. When using for the current output (C14-7, 8 = 3), set the L bit to the current mode side. Refer to section 5-8 for details on this. When C14-7, 8 is set to 2, the parameter reference point is automatically set to 5V, and the output value gain is set to 0.5-fold.

A gain can be applied on the internal parameter value set with C13-0, 1.

Set this gain with C14-0, 1.

When C14-7, 8 is set to 2 and the output gain is set with C14-0, 1, the gain will be $(0.5 \times C14-0, 1)$.

Of the parameters selected with C13-0, 1, those shown below are coded with a plus/minus sign. When these parameters are selected, plus or minus can be added by offsetting the output value.

Set C14-3, 4 for the voltage output, and C14-5, 6 for the current output.

Setting value	Parameter	Full scale
0	Output frequency	Max. frequency
1	Setting frequency Setting speed	Max. frequency Max. speed
10	Motor speed	Max. speed
11	Torque current	Motor rated current $\times 2$
12	Excitation current	Motor rated current $\times 2$
13	Actual motor rotation speed	Max. speed
14	Namp output	Rated torque

An example of setting a 5V offset for the voltage output is shown below.

If C14-7, 8 is set to 2, the offset amount when the offset is set with C14-3, 4 becomes $(5V + C14-3, 4 \text{ setting value})$.

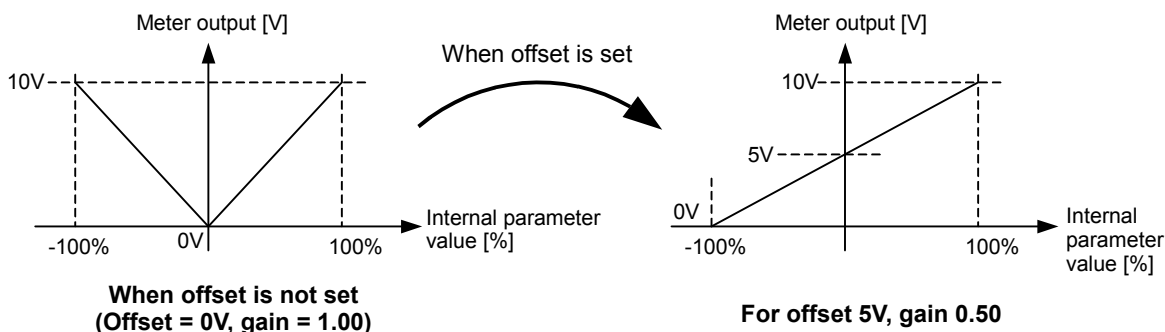

(Note 2) If plus or minus is set with offset, the signal is not output from A01, A02 when the power is shut off, so the output will be 0V (-100% in above example).

C14-2

Random scale display coefficient

Set the display value coefficient for the monitor parameter D00-4 (output frequency, speed random scale display) and D01-4 (set frequency, speed, ramp input random scale display). The result of multiplying the output frequency or set frequency, etc., with this setting value is displayed at D00-4, D01-4).

C14-9~B

AI1, AI2, AI3 random scale coefficient

Set the random scale coefficient of the value displayed at monitor parameter D08-0 to 2 (analog input AI1, AI2, AI3 random scale display).

C15-0

Attainment (ATN) detection width

The attained output ATN operation width is set. Set with a percentage to the max. frequency (B00-4) or max. speed (B01-4).

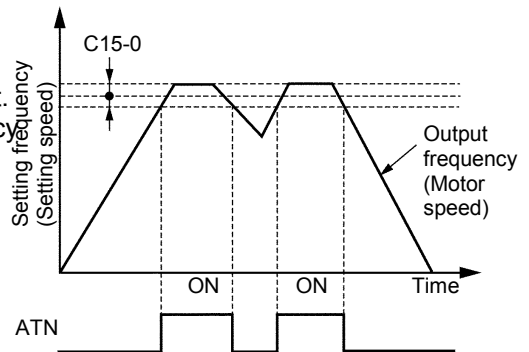

C15-1

Current (IDET) detection level

The current detection (IDET) operation level is set. Set with a percentage of the rated current (B00-6, B01-6). A 5% hysteresis will occur with the IDET operation.

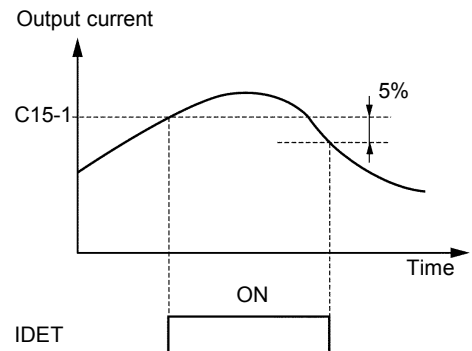

C15-2

Speed detection (SPD 1) level - 1

C15-3

Speed detection (SPD 2) level - 2

The speed detection SPD 1 and 2 operation level is set. Set with a percentage to the max. frequency (B00-4) or max. speed (B01-4). The output frequency or the motor speed will be the comparison target. A 1% hysteresis will occur with SPD1 and 2 operation.

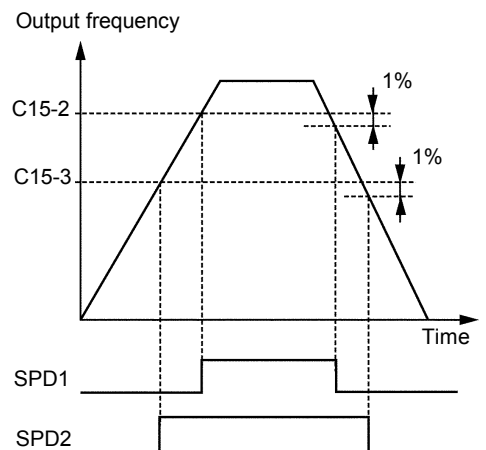

C15-4

Zero speed detection (ZSP) level

The zero speed detection ZSP operation level is set. Set with a percentage to the max. frequency (B00-4) or max. speed (B01-4). The output frequency or the motor speed will be the comparison target. A 1% hysteresis will occur with ZSP operation.

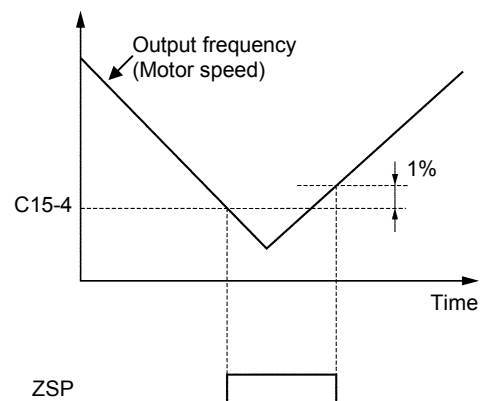

C15-5

RDELAY output delay time setting

Set the delay time from sequence output RUN OFF to RDELAY OFF in the sequence output RDELAY.

Set the time with a 0.1 s unit.

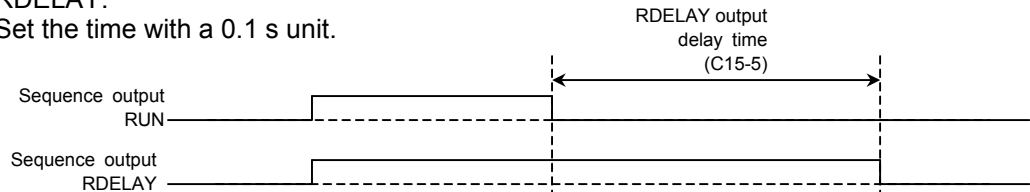

If the sequence output RUN turns ON again during the delay time, the ON state will continue. The conditions that cause DELAY to turn OFF at the subsequent RUN OFF will be applied after the delay time elapses again.

(Note) RDELAY is reset if the power is turned OFF.

C15-6~9

EC0 to 3 output fault selection

Set the details of the fault assigned to the sequence output EC0 to 3 with the following configuration.

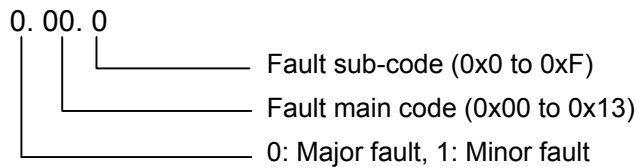

C15-A~E

EC0 to 3, ALM OFF delay timer

Set the output hold time for the sequence output assigned to the minor fault output

Note that 0.0 is the setting value for holding the sequence output to the input of the fault reset signal (RST).

C20-0
C20-1
C20-2
C20-3

Start/stop frequencies (speeds)

Start/stop frequency (speed) hysteresis

Interlock frequency (speed)

Run delay timer

The following types of interlock can be obtained for the run RUN and R-RUN commands.

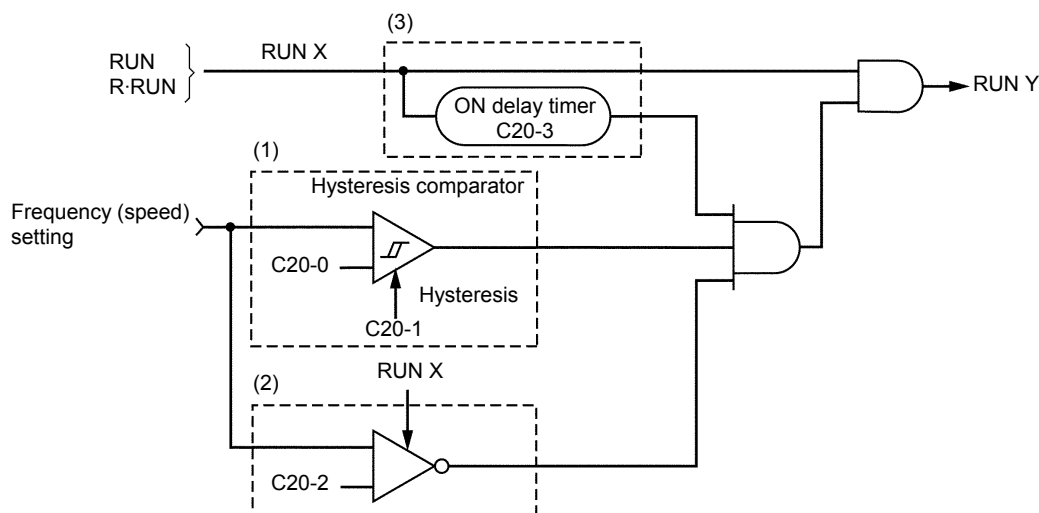

- (1) **Setting start/stop function**
The motor will run when the frequency (speed) setting is higher than the C20-0 setting value, and will stop when lower.
- (2) **Start interlock**
If the frequency (speed) setting value is larger than C20-2 when the run command (RUN X) is ON, the motor will not start.
Use this function when the frequency setting is to be lowered when starting for safety purposes.
Set C20-2 to 0 when not using this function.
(Note) When using the set operation start/stop and set interlock function together, set a higher interlock frequency value than that for the set operation start/stop frequency.
- (3) **Run delay timer**
The motor will be delayed from the run command (RUN X) by the time set in C20-3.

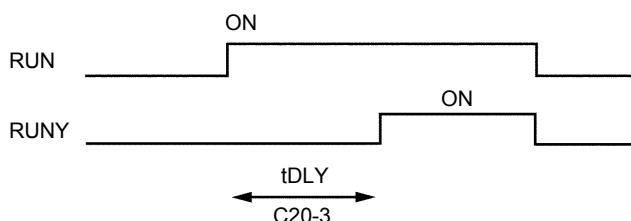

This is used for synchronization with peripheral machines such as mechanical brakes. The run delay timer will not function in the jogging or local modes.

(Note 1) Set the parameter setting values to 0 when not using (1), (2) or (3).

(Note 2) The (1), (2) and (3) functions will not function during jogging run.

(Note 3) The (3) function will not function during the local mode.

(Note 4) When interlock is applied on (1), (2) or (3), the FWD and REV LED will flicker.

C21-0
C21-1

Number of retries

Retry wait time

Retry is a function that performs its own fault reset and restarts with pick-up. Set the number of retries, and the wait time (t_{RW}). If pick-up is not possible within the number of set times, an IO-4 fault will occur.

The errors that are targets of retry are power module (P \bar{n} - n), overcurrent (OC - n), overvoltage (OV - n)^(Note 3), overload (OL - n), overheat (UOH), and ground fault (GFD).

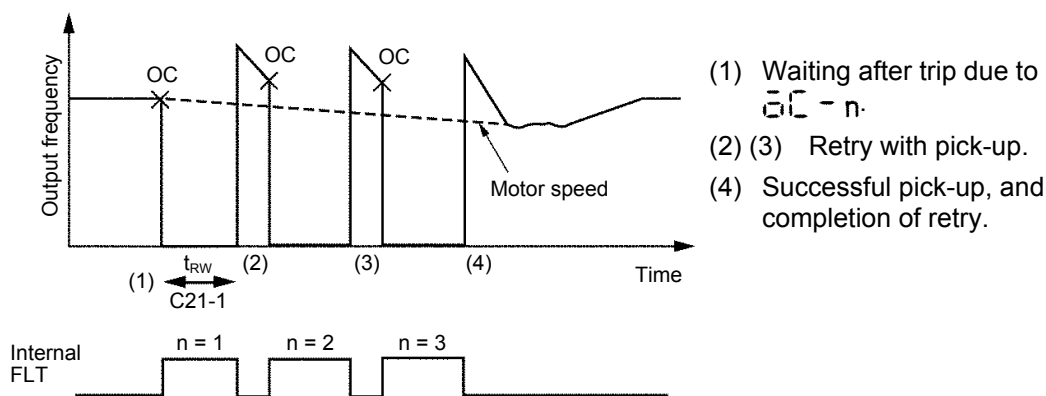

- (Note 1)** If C21-0=0, retry will not function.
- (Note 2)** The FA-FC relay output will stay open during retry, but will not function.
- (Note 3)** OVT retry may not function correctly if the DC voltage drop is slow.
- (Note 4)** If the run command turns OFF during retry, the retry will be canceled, and the FA-FC relay contact output will turn ON.
- (Note 5)** The pick-up operation is not carried out during vector control with IM sensor and PM motor control (C30-0 f0 = 3,4).

!	CAUTION
<p>When a fault occurs on an extremely rare case, this function automatically resets the fault and restarts the operation. If the fault occurs frequently, the inverter could be damaged, so first remove the cause of the fault.</p>	

C21-2

Pick-up wait time

The wait time t_{PW} after the output is cut off to when the pick-up operation is started is set. Set the time to when the motor residual voltage is abated for this parameter. (The residual voltage is a voltage generated by the motor after the inverter output turns OFF, and will be abated in approx. 1 to 5 seconds. This abatement time will take longer if the motor capacity is large.)

C21-3

Pick-up current limit value

The current limit value during pick-up is set. This setting value is applied only during pick-up. Normally, set 100% and use. Adjust within the following range only when the output torque at restart is to be limited.

$$\text{C21-3 Setting value} \geq \text{Applicable motor excitation current (\%)} + 10\%$$

(Normally 30 to 40%)

<Pick-up operation (When V/f control is selected)>

Pick-up starts when RUN or R.RUN is ON in the PICK ON state or when the power is turned on when auto start with pick-up is selected (C08-0=3).

The pick-up operation is carried out with the overcurrent limit function as shown below.

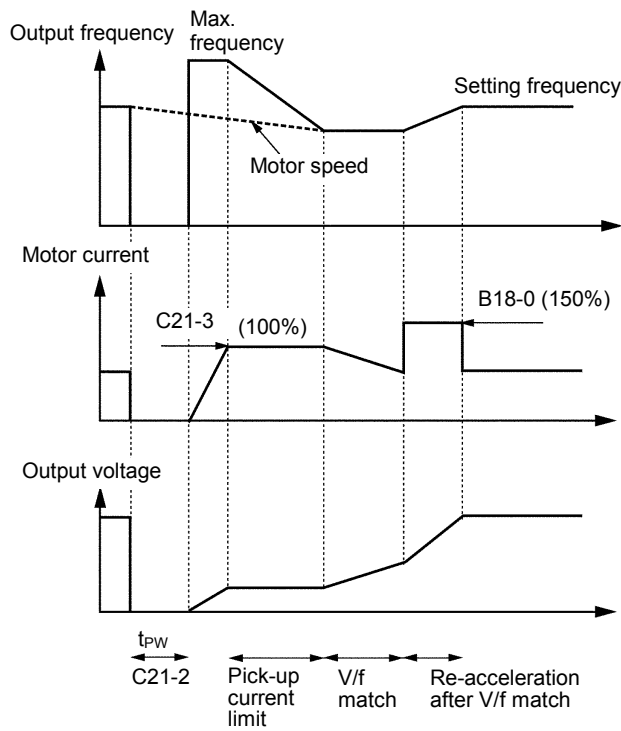

C21-4

V/f pick-up function selection

Select the pick-up function for when V/f control is selected (C30-0 f_0 =1).

=1: No reverse run pick-up

Select this to restart the motor rotating in the same direction as the command when restarting after an instantaneous power failure. The motor will restart with the overcurrent limit from the maximum frequency in the same direction as the command.

=2: Reverse run pick-up enabled (FMAX)

Select this to restart the motor rotating in the same or reverse direction as the command when restarting after an instantaneous power failure. The motor rotation direction is detected first, and then is restarted with overcurrent limit from the maximum frequency in the detected direction.

=3: Reverse run pick-up enabled (estimated speed)

Select this to restart the motor rotating in the same or reverse direction as the command when restarting after an instantaneous power failure. First the motor rotation direction and frequency are detected, and then the motor restarts with the overcurrent limit from the frequency (detected value +10%) in the detected direction.

C21-5

Sensor-less pick-up function selection

Select the pick-up function for IM speed sensor-less vector control.

=1: Reverse run pick-up disabled, start search from NMAX

=2: Reverse run pick-up disabled, start search from setting value

=3: Reverse run pick-up enabled, start search from NMAX

C21-6

Speed estimation proportional gain for sensor-less pick-up

Set the speed estimation proportional gain used for pick-up during IM speed sensor-less vector control.

C21-7

Speed estimation integral gain for sensor-less pick-up

Set the speed estimation integral gain used for pick-up during IM speed sensor-less vector control.

C22-0
C22-1
C22-2
C22-3

Motor overload reference (L0)

0Hz overload (L2)

0.7 Fbase freq. overload (L1)

Motor overload breakdown reference

The operation reference for overload (OLT) is set.

(1) Unit overload (OL-1)

Overload protection is performed under the following conditions based on the machine rated current reference.

The reference is judged as an overload when the C22-0 setting value is exceeded.

C30-0 $\overline{f1}$ = 2 (Heavy-duty)
 150% for one minute, 175% for 2.5 seconds

C30-0 $\overline{f1}$ = 1 (Normal-duty)
 120% for one minute, 140% for 2.5 seconds

However, the overload reference is reduced by 50% at an output frequency of 1Hz.

The machine overload can be monitored at D02-2. Furthermore, analog output is possible if the setting value 15 is selected at C13-0, 1.

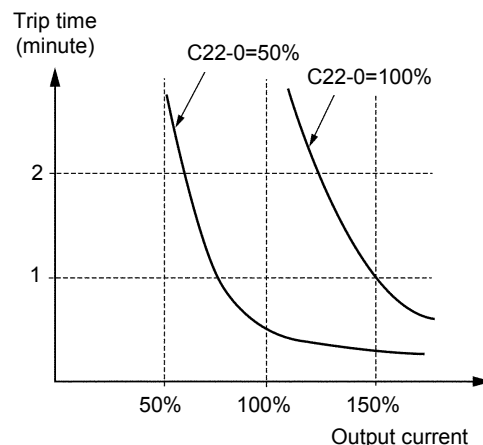

(2) Motor overload (OL-3)

Use the C22-3 setting to set the trip breakdown reference current for one minute in the case of a motor rated current (B00-6, B01-6) of 100%. When C22-3 is set to 120% for example, if C22-0 is 100%, and 120% of the motor rated current is output, a breakdown stop will occur due to a motor overload after one minute.

As shown in the diagram on the right, the counterclockwise limit characteristics change by setting C22-0. The diagram on the right is an example with C22-0 set to 100% and 50% when C22-3=150%.

For the self-cooling motor, when operating at low speed, set C22-1 and C22-2 to meet the motor characteristics. These characteristics are as shown in the diagram on the right.

The motor overload can be monitored at D02-6. Furthermore, select setting value 8 at C13-0, 1 to enable analog output.

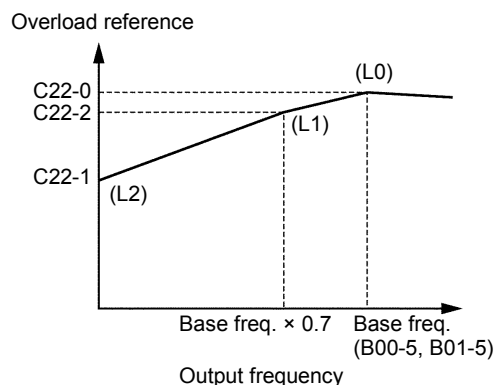

C22-4

DBR overload

This parameter is for setting %ED of DB operation. When DB transistor or DBR built in the unit is used, set the parameter within the specification.

When 0.0 is set, the protection function is disabled. When the external DB unit is used, set to 0.0.

C22-5

Motor power loss braking setting

When the motor loss braking function is activated, set the voltage to increase with the base frequency as a percentage in respect to the rated output voltage (B00-3). Normally, 50% of the default value is set.

When the DC voltage attempts to rise due to deceleration operation or a regenerative load, the motor loss braking function raises the inverter output voltage and decreases the motor efficiency to prevent tripping by an overvoltage. This function is valid only when the motor loss braking is selected with the main circuit option selection (C31-0 f_0 = 2) in the V/f control mode (C30-0 f_0 = 1).

(Note 1) Take care to motor heating.

(Note 2) If the normal V/f setting is inappropriate, the motor efficiency will increase when the voltage is increased and thus tripping by the overvoltage could occur easily.

C22-6

Carrier frequency automatic reduction function selection

Select the validity of the function to automatically reduce the carried frequency to 2kHz when the inverter output current exceeds 110% of the unit's rated current and the cooling fin temperature exceeds the reference value 1, and for when the cooling fin temperature exceeds the reference value 2 regardless of the current.

C22-7

Phase failure detection function selection

Select the validity of the input/output phase failure detection function

f0: Input phase failure detection function selection

1: Function valid 2: Function invalid

f1: Output phase failure detection function selection

1: Function valid 2: Function invalid

(1) Input phase failure detection

When this function is valid, a fault will be output if the inverter output current exceeds the level 55% or higher than the unit's rating and the DC voltage pulsation width exceeds 15% of the rated voltage (400V series: 600V, 200V series: 300V) for approx. 3 seconds.

(2) Output phase failure detection

When this function is valid, if the output current's 3-phase average value during normal operation exceeds 30% of the motor rated current and one of the phases has not reached 7.5% of the motor rated current, a fault will be output. A judgment time of 0.3 seconds is required when the operation frequency is 40Hz or more, and a time of the output cycle \times 12-fold is required when the frequency is less than 40Hz.

(Example: When the output frequency is 5Hz, the judgment time is 0.2 seconds \times 12 fold = 2.4 seconds)

C24-0

Overspeed protection level

Set the overspeed protection level. Set as a percentage in respect to the maximum frequency (B00-4) or maximum speed (B01-4). The output frequency or motor speed is the target for comparison.

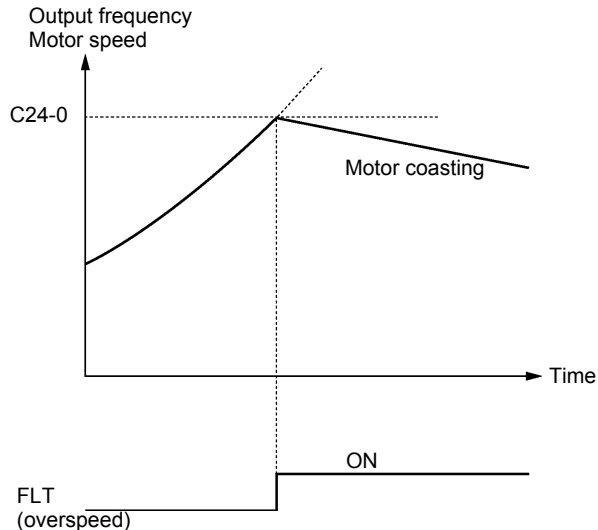

C24-1

Control mode changeover during speed detection error

This is valid when vector control with IM sensor (C30-0 $f_0 = 3$) or PM motor control (C30-0 $f_0 = 4$) is selected.

- = 1: The speed detection error is not monitored.
- = 2: The speed detection error is monitored, and if an error occurs, a fault (FLT) is output. The motor then coasts to a stop.
- = 3: The speed detection error is monitored, and if an error occurs, a minor fault (ALM) is output. The control changes from the vector control with IM speed sensor to the IM speed sensor-less vector control, and the operation is continued. When the speed detection returns to the normal state, the control changes again from the sensor-less vector control to the vector control with sensor, and the minor fault output is cleared. The presence of a minor fault due to a speed detection error can be confirmed with the minor fault monitor (D05-0). This is available only during vector control with IM sensor.

C24-2

Speed detection error level

C24-3

Speed detection error recovery level

This is valid when C24-1 = 3.

Set as a percentage in respect to the maximum speed (B01-4).

If the deflection of the speed detection value per 2ms increases above the value set with C24-2, it is judged as a speed detection error, and the control changes from the vector control with sensor to the sensor-less vector control. After changing, when the deflection of the speed estimated value for sensor-less vector control and the speed detection value drops to below the value set with C24-3, it will be judged that the speed detection has returned to the normal state. The control changes again from the sensor-less vector control to the vector control with sensor.

C24-4
C24-5
C24-6

Control mode changeover during speed deviation error

Speed deviation error level

Speed deviation error judgment time

A speed deviation error occurs when the speed command and speed detection difference is the same or higher than the speed deviation error level (C24-5), and this situation continues for longer than the speed deviation error judgment time (C24-6).

C24-7

Reverse error detection level

Set the error detection level for when the motor rotates in the reverse direction of the speed command.

Set using the base frequency as 100%.
The error is not detected when 0 is set.

C25-0

High-efficiency operation Voltage reduction time

This setting value is the time to reduce the output voltage from the V/f setting value to 0V after the output frequency reaches the set frequency.

Normally, the default value (10.0) is set. When using for loads with sudden torque fluctuations, and the output frequency drops remarkably with the overcurrent limit function, set an appropriately low value. If the rotation becomes unstable during the voltage reduction or recovery operations causing a trip, set an appropriately high value.

The high-efficiency operation function is valid when V/f control is selected (C30-0 $f_0 = 1$) or auxiliary drive is selected.

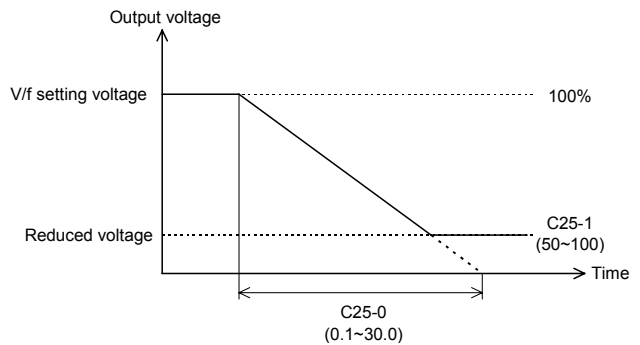

C25-1

High-efficiency operation Voltage lower limit setting value

Set a value between 50 and 99 while the inverter is stopped to select the high-efficiency operation function.

When not using the high-efficiency operation function, set 100 while the inverter is stopped.

This setting value is the lower limit of the output voltage reduced when the high-efficiency operation function is selected, and uses the V/f setting voltage (output voltage when not using high-efficiency operation) as the reference.

Normally, the minimum value (50) is set. When using for loads with sudden torque fluctuations, and the output frequency drops remarkably with the overcurrent limit function, set an appropriately high value.

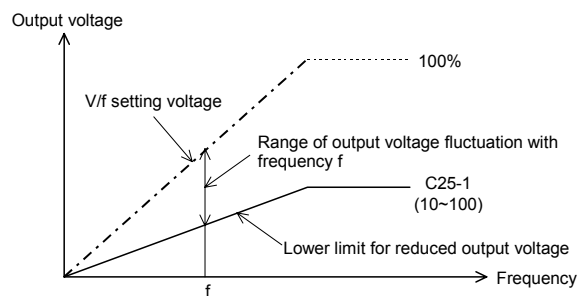

6. Control Functions and Parameter Settings

(Note) Slipping will increase during high-efficiency operation, so it is recommended to execute automatic tuning before operation and set the automatic torque boost selection to valid (A02-1 = 2).

<Operation of high-efficiency operation>

Normally for the V/f constant operation, the no-load loss is large with a light load, and the motor efficiency drops remarkably. Thus, according to the load, the output voltage is reduced using the C25-1 setting value as the lower limit in respect to the voltage set with V/f, and the motor efficiency is improved.

C25-2

Cooling fan ON/OFF control

= 1: ON/OFF control is enabled = 2: ON/OFF control is disabled

When ON/OFF control is enabled, the cooling fan runs only during inverter operation, and automatically stops when the inverter's heat sink temperature drops below a set temperature. However, the fan is run for 10 seconds after the inverter power is turned ON so confirm that the fan runs correctly. When ON/OFF control is disabled, the cooling fan always runs.

C26-0

Standard serial communication setting Function selection

Select the serial communication method.

- 1: Standard serial..... This is Meidensha's original protocol using ASCII codes.
- 2: MODBUS High-speed communication using binary codes is possible.

C26-1

Standard serial communication setting Parameter protection function

The parameters shown with circles in the following table can be changed.

Setting value	Parameter A	Parameter B, C			
		Basic	Extend	S/W	H/W
1	○	○	○	○	○
2	×	×	×	×	×
3	○	×	×	×	×
4	○	×	○	×	×
5	○	×	○	○	×

○: Changeable ×: Unchangeable

C26-2

Standard serial communication Station No.

Set the local station No. for serial communication.

C26-3

Standard serial communication Response timer

Set the minimum time for returning an answer after receiving a command during serial communication.

When MODBUS communication is selected, the data frame reception complete judgment time (silent time) will be applied.

C26-4

Standard serial communication Baud rate setting

Set the baud rate for serial communication.

- =1 : 4800bps =2 : 9600bps =3 : 14400bps =4 : 19200bps =5 : 38400bps

C26-5

Standard serial communication Stop bit setting

Set the number of stop bits for serial communication.

=1: 1bit =2: 2bit

When MODBUS communication is selected, the parity setting (C26-2) has a priority. The value is fixed to 2 bits when parity is disabled, and 1 bit when parity is enabled.

C26-6

Standard serial communication Parity setting

Set the parity for serial communication.

C26-7

Base section serial communication frequency (speed) unit setting

Set the unit used as a reference for writing and reading the frequency command (speed setting command) value for the FW/FR command in the standard serial transmission function or one of the function03h, 10h settings in the Modbus communication function.

Example : C26-7=0 (for 0.01Hz or 0.1min⁻¹ unit)

Standard serial command: (G01FW00000003000) :

For V/f setting : 30.00Hz is written

For vector or PM setting : 300.0min⁻¹ is written

Modbus command: 0110000000020400000BB8F4ED :

For V/f setting : 30.00Hz is written

For vector or PM setting : 300.0min⁻¹ is written

Example : C26-7=2 (for 0.01% unit)

Standard serial command: (G01FW00000003000) : 30.00% is written

Modbus command: 0110000000020400000BB8F4ED : 30.00% is written

% is a percentage of when 100% is the maximum frequency (B00-4) or maximum speed (B01-4).

When C26-7 is set between 3 and 5 unsigned, the - value is invalidated.

C28-0

Password No. function valid

Set the validity of the password No. when changing parameters.

=1: Function invalid =2: Function valid

When the password No. function is valid and the panel data protection function (C09-0) is set to a value other than 1, 6, or 9, C09-0 will be locked (changes disabled). To unlock the parameter, input the value recorded in Password No. Setting (C28-1) at Password NO. input (U00-1).

C28-1

Password No. setting

Set the password No. used when the password No. function is valid. Once set the display will return to 0, so make sure not to forget the set number. The default password No. is "0000", but once the password has been set, it cannot be reset to the default value even if default value load (C09-7) is executed.

C30-0

Control mode selection

Select the control mode. This parameter is set with the two digits **f1** and **f0**.

f1: Select the unit overload mode.

=1: Normal-duty (120%/1min)

=2: Heavy-duty (150%/1min)

f0: Select the control mode.

=1: V/f control

=2: IM speed sensor-less vector control

=3: Vector control with IM speed sensor

=4: PM motor control with sensor

=5: Sensor-less PM motor control (for future use)

(Note) When this parameter is changed, the motor overload breakdown reference (C22-3), overcurrent limit (B18-0), rating related parameter (B00, B01), manual torque boost voltage (A02-2), DC brake voltage (A03-0), as well as these settings in the auxiliary drive (B20 to 2F) will automatically be changed to the specified values when the parameter change is set by pressing the  key on the operation panel. Always set this parameter first.

C31-0

Main circuit option selection

Select the usage of the motor loss braking and DB resistor (built-in or external).

Refer to the explanation on the motor loss braking setting (C22-5) for details on the motor loss braking function.

The motor loss braking function is valid when V/f control is selected (C30-0 **f0** = 1) or auxiliary drive is selected.

C31-1

Ground fault detection function

Set the validity of the ground fault detection function.

When this function is valid, the output current's zero phase will be detected. If higher than the judgment value (approx. 50% of the unit rated current), a fault will be detected.

=1: Detection valid =2: Detection invalid

C31-2

UVL proportional gain

C31-3

UVL integral time constant

Set the gain for lowering the frequency at the start of UVL operation.

The UVL function will be turned OFF if the UVL proportional gain is set to 0.

Normally, a value approx. half of the motor rated slip is set for the UVL proportional gain.

If the fault is UVT instead of UVL, reduce the UVL integral time constant.

C33-0

PS04 output parameters

C33-1

PS05 output parameters

C33-2

PS06 output parameters

C33-3

PS07 output parameters

In the same way as C13-2 to 6, select the number of the signal to be output from Table 6-1.

Refer to the Relay Option Manual for details on the output terminals.

This parameter does not appear when the relay option PCB is not mounted.

C34-6

Data range selection

Select the data range for the transmission input/output data.

Data Range Selection Table.

Setting value	Data size	Sign	Frequency setting		Speed setting	
			Data range	Unit	Data range	Unit
0	16bit	Unsigned	0d~44000d	0.01Hz	0d~65535d	0.1min ⁻¹
1			0d~4400d	0.1Hz	0d~7200d	1min ⁻¹
2			0d~10000d	0.01%	0d~10000d	0.01%
3		Signed	-32768d~32767d	0.01Hz	-32768d~32767d	0.1min ⁻¹
4			-4400d~4400d	0.1Hz	-7200d~7200d	1min ⁻¹
5			-10000d~10000d	0.01%	-10000d~10000d	0.01%
6	32bit	Unsigned	0d~44000d	0.01Hz	0d~72000d	0.1min ⁻¹
7			0d~4400d	0.1Hz	0d~7200d	1min ⁻¹
8			0d~10000d	0.01%	0d~10000d	0.01%
9		Signed	-44000d~44000d	0.01Hz	-72000d~72000d	0.1min ⁻¹
10			-4400d~4400d	0.1Hz	-7200d~7200d	1min ⁻¹
11			-10000d~10000d	0.01%	-10000d~10000d	0.01%

C50-0

Encoder pulse divided output setting

When using the speed detection option V24-DN1, DN2, the signals input from the encoder can be divided by 1/N, and output as 2-phase pulses (A, B phases) with 90° phase difference from the PAOUT and PBOUT terminals.

Set the division ratio N with this parameter.

Adjust the setting value so that the output signal is up to 70kHz.

C50-1

2-phase, 1-phase encoder selection

Select the number of signals (2-phase, 1-phase) for the encoder being used.

C50-1 = 1: This is set when using an encoder that outputs a 2-phase pulse (A, B-phase) having a 90° phase difference.

The rotation direction can be judged, and the speed can be stably controlled even at low speeds.

Set the No. of pulses for one phase in the No. of encoder pulses (B01-8).

C50-2 = 2: This is set when using an encoder that outputs a 1-phase pulse.

Connect the input signal to the A or B phase input, and always leave one phase unconnected.

The 1-phase pulse signal for a proximity sensor, etc., is converted internally into a 2-phase signal.

With the 1-phase pulse mode, the rotation direction is recognized as the operating command direction. The forward run and reverse run directions are not judged.

A speed detection error could occur due to the effect of chattering in low speed areas, so use a 2-phase encoder when carrying out low-speed run or forward/reverse run.

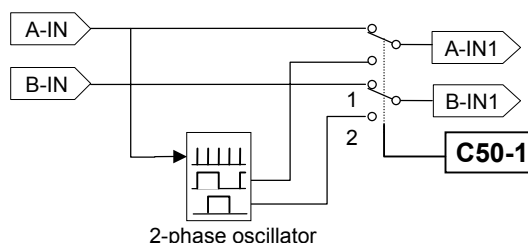

(Note 1) The 1-phase pulse mode cannot be used with the PM control mode.

(Note 2) The speed detection direction (symbol) when 1-phase input is selected is determined based on the movement direction.

(Note 3) In the case where ACR control is performed using vector control with an IM speed sensor when 1-phase input is selected, this is identified as the rotation direction outlined in Note 2. Exercise due caution with regards to the acceleration direction.

C50-2

Encoder AB advance direction selection

The motor's rotation direction is judged by the advance and delay of the encoder's A and B phase pulse phase.

Refer to the following diagram and set this parameter according to the phase relation of the encoder's AB phase signal during forward run (CCW rotation).

(Note) If C50-2 is set to 2, set C50-3 to 0.

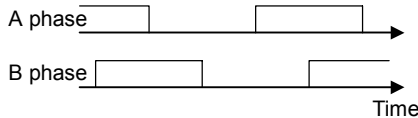

(a) When C50-2 is 1 (CCW rotation)

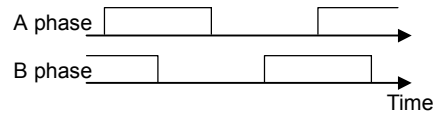

(b) When C50-2 is 2 (CCW rotation)

C50-3

Encoder ABZ pulse type selection

When using an encoder with signal specifications which cannot be handled with the C50-2 and C51-2 settings, set C50-3 and invert or interchange the signals.

(Note) When C50-2 and C51-2 are set, set C50-3 to 0 (signal invert/interchange invalid).

The signal conversion circuit will operate with the combinations shown below according to the C50-3 setting No.

C50-3 setting value	A-IN Non invert / Invert	B-IN Non invert / Invert	Z-IN Non invert / Invert	AB interchange
0	-	-	-	Interchange invalid
1	Invert	-	-	
2	-	Invert	-	
3	Invert	Invert	-	
4	-	-	Invert	
5	Invert	-	Invert	
6	-	Invert	Invert	
7	Invert	Invert	Invert	AB interchange
8	-	-	-	
9	Invert	-	-	
10	-	Invert	-	
11	Invert	Invert	-	
12	-	-	Invert	
13	Invert	-	Invert	
14	-	Invert	Invert	
15	Invert	Invert	Invert	

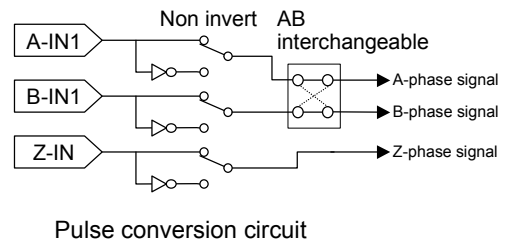

C-51-0

Encoder selection

Select the type of encoder signals being used.

- =1 : A, B, Z-phase + U, V, W-phase signal
- =2: A, B, Z-phase + serial absolute signal
- =3: A, B, Z-phase + U, V, W-phase signal (reduced wiring)
- =4: SIN, COS signal

C-51-1
C-51-2

AB phase-Z phase type selection
Encoder Z signal reversal

With the VT240S, the A, B and Z phase pulse encoder signals are defined as waveforms which are generated as shown below during forward run (CCW rotation).

C51-1 is set according to the relation of the A phase signal's rising edge and Z phase signal phase. With this setting and at a time of reverse running, the A phase signal's down edge during the Z phase being high is the zero point.

Set C51-1 to 0 when the A phase signal's rising edge is generated while the Z phase signal is High (Fig. (a)). In this case, the A phase signal's rising edge is the zero point (magnetic pole position). In all other cases, set C51-1 to 1. In this case, the Z phase signal rising edge is the zero point. (Fig. (b)) In this case, the Z phase rising edge is the zero point even at a time of the reverse running.

If the Z phase signal needs to be inverted to match the signal definition shown below, set C51-2 to 1.

(Note) When C51-2 is set to 1, set C50-3 to 0.

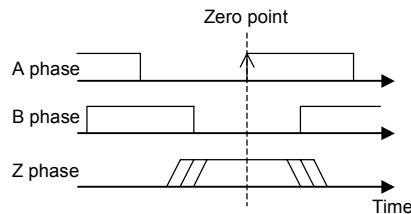

(a) When C51-1 is 0 (CCW rotation)

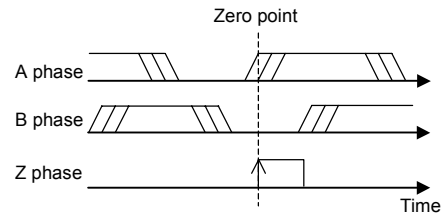

(b) When C51-1 is 1 (CCW rotation)

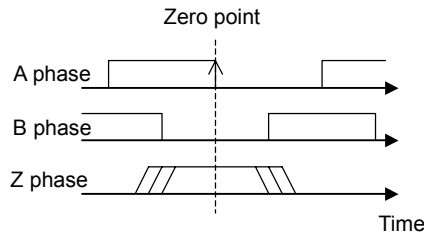

(c) When C51-1 is 0 (during CW rotation)

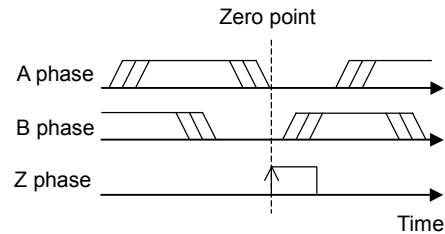

(d) When C51-1 is 1 (during CW rotation)

C-51-3
C-51-6

Encoder UVW advance direction selection
Encoder UVW pulse type selection

Set these parameters when using an A, B, Z phase + U, V, W phase signal encoder or reduced wiring type A, B, Z phase + U, V, W phase signal encoder.

When using the reduced wiring A, B, Z phase + U, V, W phase signal encoder, the VT240S defines the initial signals input to the A, B, Z phases signal cables as the U, V and W phase signals respectively.

Refer to the following diagram and set C51-3 according to the encoder's U, V, W phase signal phase relation during forward run (CCW rotation).

6. Control Functions and Parameter Settings

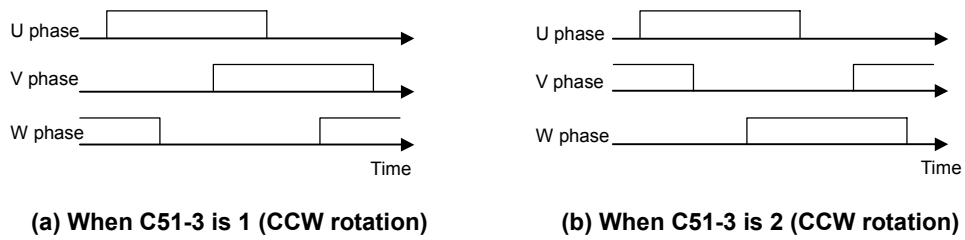

When using an encoder with signal specifications which cannot be handled with the C51-3 setting, refer to the following diagram and table and invert the signals by setting C51-6. When C51-3 is set to 2, set C51-6 to 0 (signal invert invalid).

Setting No.	U-IN Non invert / Invert	V-IN Non invert / Invert	W-IN Non invert / Invert
0	-	-	-
1	Invert	-	-
2	-	Invert	-
3	Invert	Invert	-
4	-	-	Invert
5	Invert	-	Invert
6	-	Invert	Invert
7	Invert	Invert	Invert

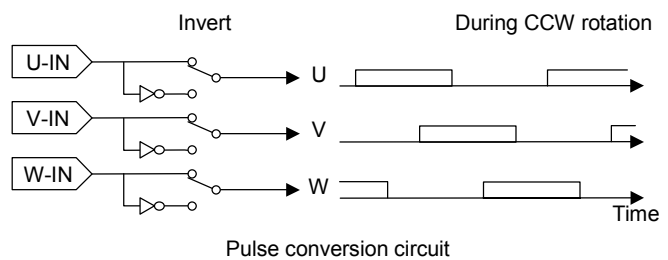

C51-4

Z-IN → U phase winding phase angle

Observe the encoder's Z phase pulse and the inter-linear voltage waveform across the motor terminal UV phases during forward run (CCW rotation), and obtain the phase angle (electric angle) from the relation shown below using the Z phase pulse as a reference. This parameter can be automatically adjusted with the automatic tuning function. Refer to section 3-5-3. Refer to section 3-5-4 for the adjustment method when using the magnetic pole estimation function.

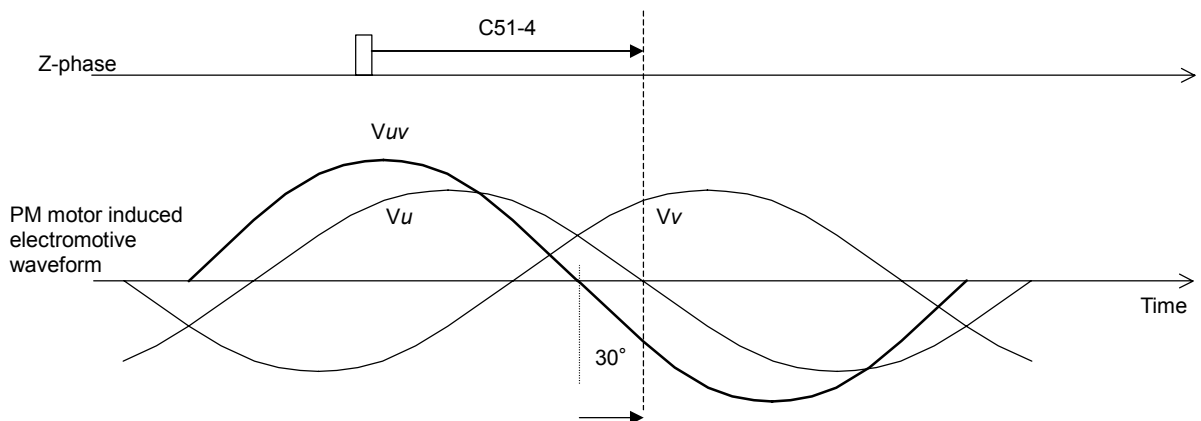

Relation of encoder Z phase pulse and PM motor induced electromotive waveform phase (during CCW rotation)

C51-5

Z-IN → U pulse angle

- 1) When using A, B, Z, phase + U, V, W phase signals or reduced wiring A, B, Z phase + U, V, W phase signals
 If there is a phase difference between the Z phase pulse and U phase pulse of the encoder in use, set the phase difference in C51-5.
 Set "0°" if there is no phase difference between the Z phase and U phase pulses.

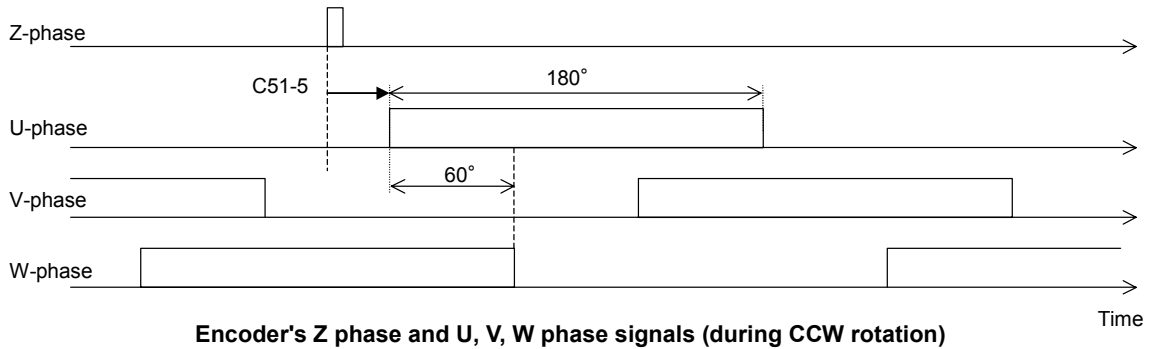

- 2) When using A, B, Z phase + serial absolute signals
 If there is a phase difference between the Z phase pulse and serial absolute signal zero point, set that phase difference with an angle unit.

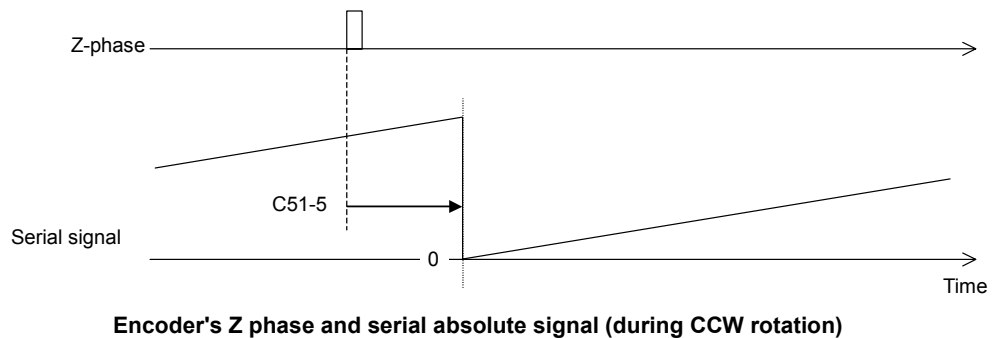

- 3) When using sine wave signals
 Set the phase of the sine wave signal when the encoder's Z phase pulse is generated in C51-5.

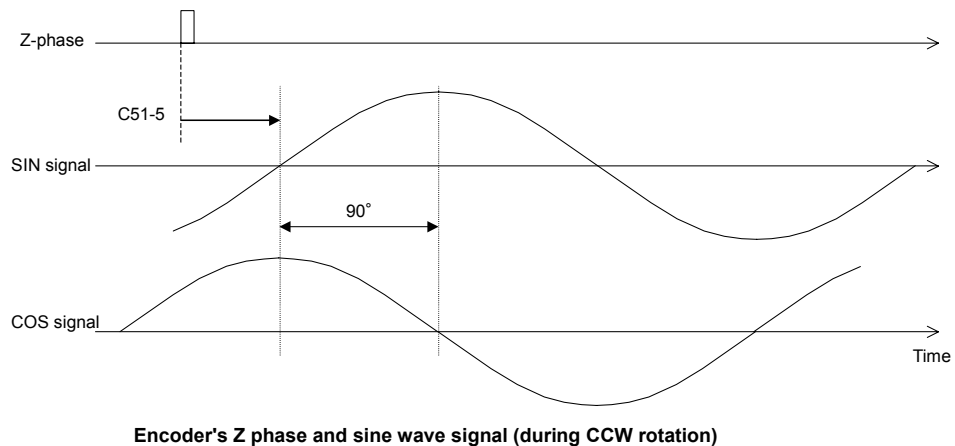

C51-7
C51-8
C51-9

UVW measurement start wait time [For reduced wiring ABZUVW]

UVW measurement end time [For reduced wiring ABZUVW]

ABZ measurement start wait time [For reduced wiring ABZUVW]

These parameters are set when using the reduced wiring type A, B, Z phase + U, V, W phase signal encoder. Set the parameters according to the specifications of the encoder in use.

When the power is turned ON to the encoder, the A, B and Z phase signal cables are at a high impedance (hereinafter, HI-Z). Set the UVW signal measurement start time in C51-7 using the time that the three signal cables are released from the high impedance state as a reference.

Set the UVW signal measurement end time in C51-8 using the UVW signal measurement start time (C51-7) as a reference.

(If the UVW signal cannot be measured within this time, the fault "SP-6" will be output.)

Set the time to start control with the ABZ signal in C51-9 using the UVW signal measurement end time (C51-8) as a reference.

(Note) The timer runs at a 2ms cycle, so all times set here must be as an integer-fold of 2.

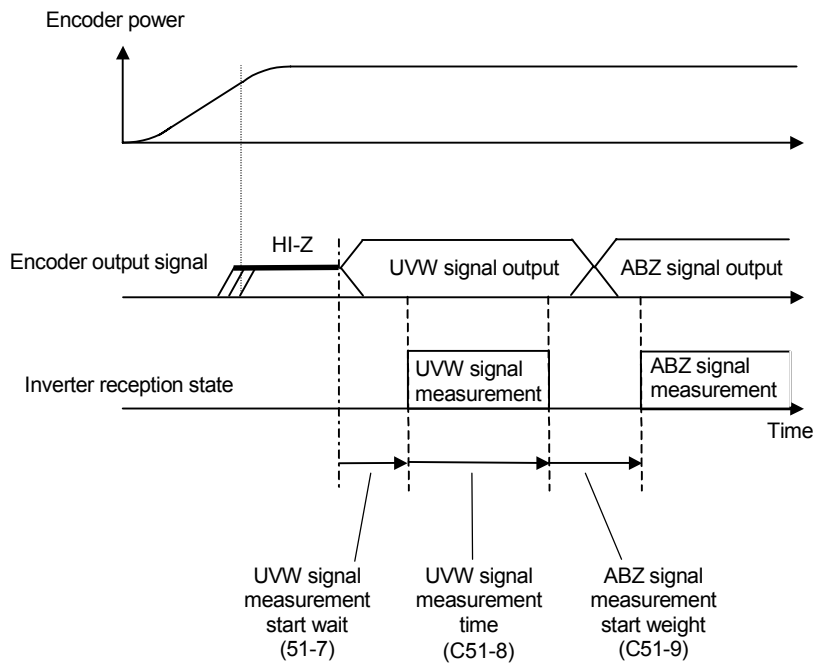

6-6-5 Explanation of Block-U parameter functions

U00-0

Parameter copy function

The inverter parameters can be saved in the non-volatile memory in the operation panel. Conversely, the saved parameters can be read to the inverter's non-volatile memory. This function is handy for setting the same parameters in several inverters. Note that all operations in this function, including save, load, verify check and clear, must be executed while the inverter is stopped.

1001: Save

The inverter parameters are saved in the non-volatile memory in the operation panel.

2002: Load

The parameters saved in the operation panel's non-volatile memory are read out to the inverter.

Note) When parameter data exceeding the set range could be read out, such as when using inverters with different capacities, the parameters outside of the setting range may be loaded and the parameter settings may be unset. In this case, always turn the power OFF and ON once. If \square . \square appears when the power is turned ON again, enter D20-2 and set the unset parameters.

3003: Verify check

The parameter data saved in the operation panel's non-volatile memory is compared against the parameter data saved in the inverter's non-volatile memory. \square . \square appears if the parameters are different.

4004: Clear

The operation panel's non-volatile memory is cleared.

U00-1

Password No. setting

If the panel data protection function (C09-0) is locked, input the four-digit value set with password No. setting (C28-1) into this parameter and unlock the function. The default password No. is "0000".

U10-0

No. of execution banks

Set the number of banks executed with the built-in PLC in the range of 0 to 5. If 0 is set, the built-in PLC function will be invalid. Refer to section 6-11 for details on the built-in PLC function.

U10-1~8

Built-in PLC parameter

Set the user parameters usable with the built-in PLC. Set with a hex value.

U20-0~7

Built-in PLC command bank A

U21-0~7

Set the built-in PLC command. The commands are executed in order from the small numbers.

U22-0~7

U23-0~7

This is valid when U10-0 is set to 1 or higher.

U24-0~7

Refer to section 6-11 for details on the built-in PLC function.

U25-0~7

U26-0~7

U27-0~7

U30-0~7

Built-in PLC command bank B

U31-0~7

Set the built-in PLC command. The commands are executed in order from the small numbers.

U32-0~7

U33-0~7

This is valid when U10-0 is set to 2 or higher.

U34-0~7

Refer to section 6-11 for details on the built-in PLC function.

U35-0~7

U36-0~7

U37-0~7

U40-0~7

Built-in PLC command bank C

U41-0~7

Set the built-in PLC command. The commands are executed in order from the small numbers.

U42-0~7

U43-0~7

This is valid when U10-0 is set to 3 or higher.

U44-0~7

Refer to section 6-11 for details on the built-in PLC function.

U45-0~7

U46-0~7

U47-0~7

U50-0~7

Built-in PLC command bank D

U51-0~7

Set the built-in PLC command. The commands are executed in order from the small numbers.

U52-0~7

U53-0~7

This is valid when U10-1 is set to 4 or higher.

U54-0~7

Refer to section 6-11 for details on the built-in PLC function.

U55-0~7

U56-0~7

U57-0~7

U60-0~7
U61-0~7
U62-0~7
U63-0~7
U64-0~7
U65-0~7
U66-0~7
U67-0~7

Built-in PLC command bank E

Set the built-in PLC command. The commands are executed in order from the small numbers.

This is valid when U10-1 is set to 5 or higher.

Refer to section 6-11 for details on the built-in PLC function.

6-7 Setting the overload mode

6-7-1 Selecting the overload mode

Select one of the following modes according to the applicable load. If there is no difference in the load and unit capacity, the unit could be overloaded. Refer to the following table and select the mode which suits the load.

Unit overload mode	Explanation	C30-0 f1
1) Normal-duty setting (Normal-duty)	Select this when the ratio of the maximum load in respect to the rated load is low. The overload reference is 120% of the unit's rated current for one minute.	1
2) Heavy-duty setting (Heavy-duty)	Set this when the ratio of the maximum load in respect to the rated load is high. The overload reference is 150% of the unit's rated current for one minute.	2

- (1) For the default setting, = 1: normal-duty setting (Normal-duty) is selected, so change the setting according to the application. When this parameter is selected, there are parameters with setting values and setting ranges that also fluctuate, so this parameter must be set before the other parameters.
- (2) The parameters with setting values and setting ranges that fluctuate when this parameter is selected are shown below.

No.	Name	Min. value	Max. value	Default value	Unit	Function
A02 - Torque boost						
2	Manual torque boost setting	0.00	20.00	(Note 1)	%	Setting of torque boost at 0Hz. This is automatically adjusted by the automatic tuning.
A03 - DC brake						
0	DC braking voltage	0.01	20.00	(Note 1)	%	This is automatically adjusted by the automatic tuning. When setting manually, monitor the output voltage and change the setting in increments of 1% or less.
B00 - Output rating						
6	Motor rated current	Normal-duty ----- Heavy-duty	Normal-duty rating Current × 0.3 to 1.0 Heavy-duty rating Current × 0.3 to 1.0	Inverter rating (Note 2)	A	Reference value for overcurrent limit, OLT, current % display, analog input and output.
B18 – Current limit						
0	Drive current limit	Normal-duty ----- Heavy-duty	50. 300.	125. (Note 3) ----- 155.	%	
C22 – Overload						
3	Motor overload breakdown reference	Normal-duty ----- Heavy-duty	110. 300.	120. ----- 150.	%	A breakdown stoppage (OL-3) will occur after 1 minute with the motor rated reference current value at this value.

(Note 1) The default value differs according to the inverter capacity and overload mode selection.

(Note 2) The normal-duty rated current value and heavy-duty rated current value shown in Table 1 are used for the unit's rating values.

(Note 3) When switching the overload mode selection from the heavy-duty setting to the normal-duty setting, 125 is forcibly set.

6-7-2 Overload characteristics

(1) Machine overload (OL-1)

The unit overload detection curve changes in sequence with the overload mode selection. The machine overload characteristics are shown below.

Note that the unit rating current for the normal-duty setting and heavy-duty setting is the reference for the current value (%).

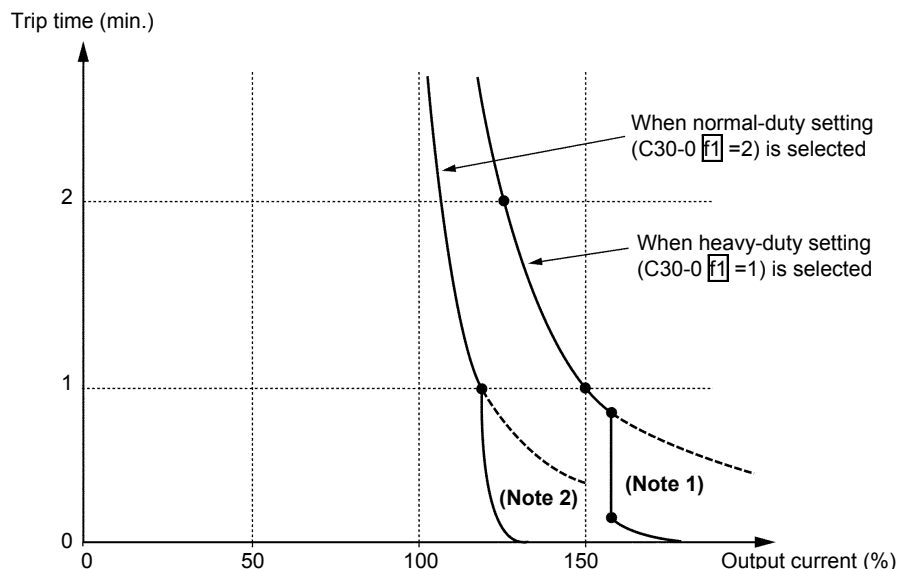

Overload characteristics (machine overload)

(Note 1) When the normal-duty setting is selected, the 120% for 60s inverse time characteristics apply.

Note that if 122% of the normal-duty rated current is exceeded, a trip will occur at the 140% for 2.5s inverse time characteristics. When the 1.0Hz or less, the trip will occur at inverse time characteristics which drop linearly to 60% for 60s of the normal-duty rated current.

(Note 2) When the heavy-duty setting is selected, the 150% for 60s inverse time characteristics apply.

Note that if 155% of the heavy-duty rated current is exceeded, a trip will occur at the 175% for 2.5s inverse time characteristics. When the 1.0Hz or less, the trip will occur at inverse time characteristics which drop linearly to 75% for 60s of the heavy-duty rated current.

(2) Motor overload (OL-3)

The motor overload is the counterclockwise limit characteristic determined based on the motor overload reference (C22-0) and motor overload breakdown reference (C22-3).

For example, if C22-0=100% and C22-3 = 120%, the motor is tripped at the motor rated current 120% for 60s. counterclockwise limit characteristic.

Refer to C22-0 to 3 in item 6-6 for further details.

6-8 Adjusting the IM vector control speed control related parameters

When running the IM with the VT240S, ASR operation is possible by executing automatic tuning and setting simple speed control parameters. However, when carrying out high-response or high-accuracy control, the parameters must be adjusted in detail. In this section, the configuration of the speed control system is explained, and the adjustment parameters that need to be adjusted are indicated.

6-8-1 Speed control system of IM vector control

The speed control system of IM vector control is configured of blocks as shown below. Automatic tuning is used for adjusting the exciting current control, current regulator, flux observer and speed estimation mechanism, so these parameters often do not need to be adjusted. However, the parameters related to the speed regulator, torque limiter, load torque observer, various low path filters, etc., must be adjusted according to the user's system. Thus, these cannot be simply adjusted with automatic tuning. The final user of the system must adjust these parameters to match the system. Adjustments are carried out while referring to the block diagram below.

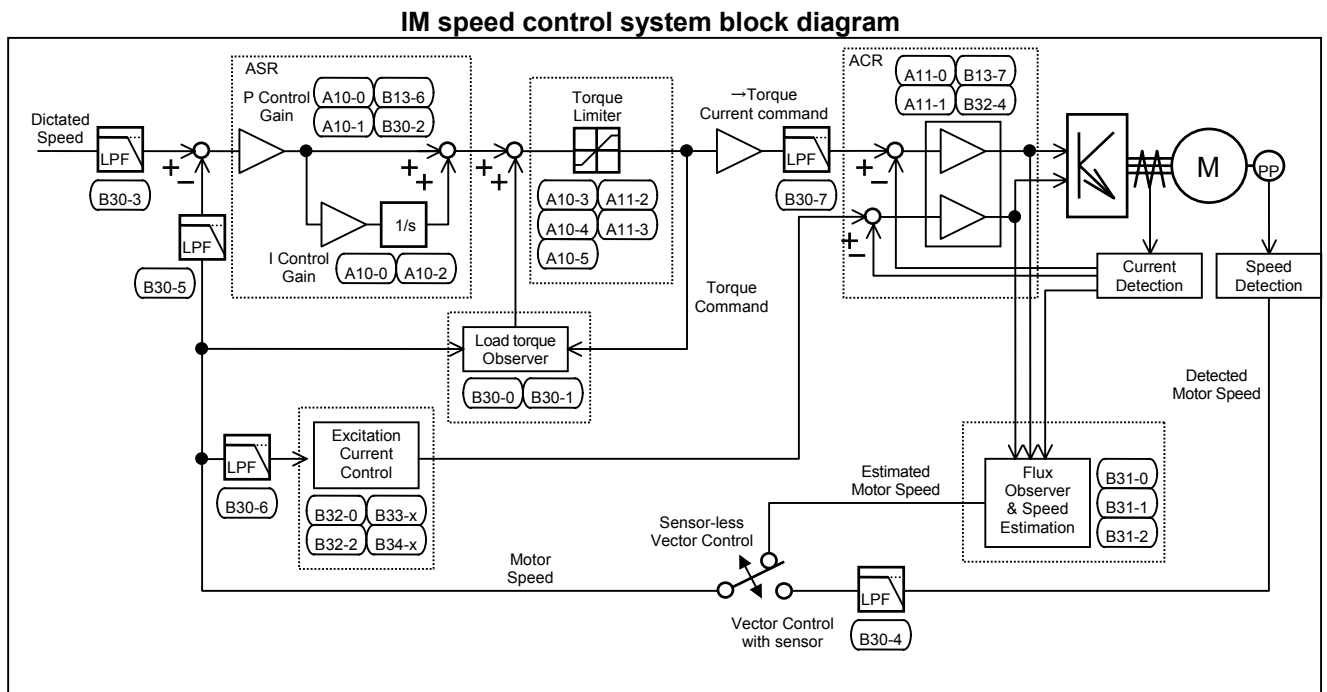

(Note) The related parameter Nos. are indicated in the above function blocks.

6. Control Functions and Parameter Settings

6-8-2 IM speed regulator

The IM motor speed regulator (ASR) is configured of PI control, and has the following parameters.

Parameter No.	Parameter	Function
A10-0	ASR response	The required ASR response radian frequency is set.
A10-1	Machine time constant-1	The time (Tm) to accelerate the motor and load's torque inertia to the base speed at the rated torque is set. (Note)
A10-2	Integral time constant compensation coefficient	The compensation coefficient applied on the integral time constant of the speed regulator (ASR) is set. Increase the compensation coefficient when the overshooting is large during speed control.
B13-6	ASR gain compensation in constant power range	This sets the ASR P gain compensation value at the max. speed. By adjusting this parameter, the ASR P can be compensated in the constant power range. If ASR hunting occurs in the sensor-less control's constant output range, set a smaller value.
B30-2	ASR proportional item change rate limit	If the speed setting value or motor speed change suddenly, this will prevent the ASR's P item from suddenly changing.

(Note) The machine time constant Tm is expressed with the following expression.

$$T_m [\text{ms}] = 10.97 \times J [\text{kg} \cdot \text{m}^2] \times (\text{Nbase} [\text{min}^{-1}]^2 / \text{Power} [\text{W}])$$

J : Total inertia [$\text{kg} \cdot \text{m}^2$] (= $1/4 \times \text{GD}^2$ [$\text{kgf} \cdot \text{m}^2$])

Nbase : Base speed [min^{-1}]

Power : Motor rated output [W]

6-8-3 Torque limiter for IM speed control

The output torque is limited. Set an appropriate value for protecting the load side.

Drive torque limiter Set this to a large value to increase the torque during driving. Note that output torque control is performed even by the output current limiter (B18-0), so when set excessively, the set torque may not be attained.

Regenerative torque limiter Set this to a large value to increase the torque during regeneration. Note that output torque control is performed even by the output current limiter (B18-0), so when set excessively, the set torque may not be attained. If the DBR or PWM converter, etc., are not provided and an excessively large setting is made, an overvoltage trip could occur during regeneration. In this case, lower the regeneration torque limiter setting.

Parameter No.	Parameter	Function
A10-3	ASR drive torque limiter	The limit value for the ASR drive side is set.
A10-4	ASR regenerative torque limiter	The limit value for the ASR regenerative side is set.
A10-5	Emergency stop regenerative torque limiter	The ASR regenerative side limit value applied during the emergency stop mode is set.
A11-2	ACR drive torque limiter	The ACR drive side limit value is set.
A11-3	ACR regenerative torque limiter	The ACR regenerative side limit value is set.

6-8-4 IM exciting current control

The exciting current is controlled to establish the secondary flux. A current reduction process in the constant output range or during voltage saturation, and high-speed magnetizing control to raise the secondary flux at a high speed are also carried out.

Parameter No.	Parameter	Function
B32-0	Speed flux control gain	This is the control gain used for high-speed control of the secondary flux when starting operation. Use this to control the secondary flux at a high speed at the start of operation or during operation in a constant output range. High speed control is possible by increasing the gain, but if increased too high, the magnetizing current may hunt.
B32-2	Voltage saturation compensation selection	If the output voltage in control is larger than the voltage that can be output by the inverter, select this control to limit the exciting current to prevent the current or torque from hunting. Select this when raising the output voltage to near the input voltage, or when the input voltage changes. Note that if voltage saturation occurs, some torque ripple will occur. In this case, lower the B01-9 no-load output voltage setting to avoid voltage saturation. Note that the output also decreases in proportion to the voltage.
B33-x	Table reference speed	This is the table reference speed used to perform excitation inductance variation compensation.
B34-x	M' fluctuation compensation	This compensates the exciting inductance fluctuation according to the B33 table reference speed. The compensation table is set in the constant output range in order that the output voltage when operation is performed with no load becomes constant. * This is adjusted by the automatic tuning mode 4. (B19-0=4)

<Setting the table reference speed>

When all of B34 is set to the default value (=100%), B33 will be automatically set as shown below when adjusted with automatic tuning mode 4 (B19-0=4).
When set manually and the motor largely fluctuates immediately after M' enters the constant output range, the voltage error can be reduced by setting the base speed carefully.

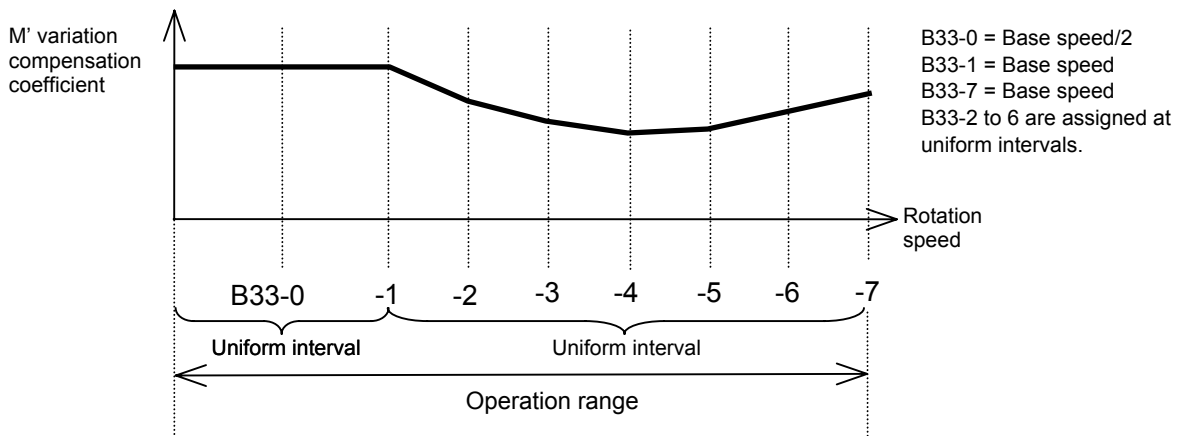

Table reference speed setting method

6. Control Functions and Parameter Settings

6-8-5 IM current regulator

The current regulator (ACR) is configured of PI control, and has the following parameters.

Parameter No.	Parameter	Function
A11-0	ACR response	The ACR response radian frequency is set. If the response is too low or too high, the current will become unstable, and the over current protection will function.
A11-1	ACR time constant	The ACR time constant is set. If the time constant is too long or too short, the current will become unstable, and the over current protection will function.
B13-7	ACR gain compensation in constant power range	This sets the ACR P gain compensation value at the max. speed.
B32-4	ACR voltage model FF selection	The voltage fluctuation caused by the leakage inductance is feed forward controlled. The current regulator (ACR) response speed will be increased. Select this if the current hunts in the high-speed operation range during sensor-less control.

6-8-6 IM flux observer and speed estimation mechanism

These are parameters used with speed sensor-less vector control.

Parameter No.	Parameter	Function
B31-0	Flux observer gain	This is the feedback gain for the flux observer. If hunting occurs at the estimated speed in the high-speed operation range, adjust within the range of 1.2 to 0.9.
B31-1	Speed estimated proportional gain	This is the proportional gain for the adaptive speed estimation mechanism. To increase the speed estimation response, set a large value. Note that if the value is too high, the speed estimation value will hunt.
B31-2	Speed estimated integral gain	This is the integral gain for the adaptive speed estimation mechanism. To increase the speed estimation response, set a large value. Note that if the value is too high, the speed estimation value will hunt.

6. Control Functions and Parameter Settings

6-8-7 IM load torque observer

The disturbance load applied on the motor is calculated and the torque command is compensated. To increase the response toward disturbance, use the load torque observer. By setting the speed regulator (ASR) to P and using the load torque observer, overshooting can be suppressed.

Parameter No.	Parameter	Function
B30-0	Load torque observer gain	Set the observer gain for the load torque observer. To increase the responsiveness of the external disturbance response characteristics, set a large gain. Note that if the gain is set too high, the output torque could hunt. When set to zero, the load torque observer will not function.
B30-1	Model machine time constant	Set the model machine time constant used by the load torque observer.

6-8-8 Various low path filters of IM vector control

The time constants of the low path filters used for speed detection, speed commands or torque current commands, etc., are set.

By adjusting these time constants, vibration caused by noise and overshooting can be suppressed. Note that if an excessively high value is set, the control performance could drop.

Parameter No.	Parameter	Function
B30-3	Speed setting LPF time constant	Overshooting can be suppressed by setting this to the filter time constant equivalent to the speed response.
B30-4	Speed detection LPF time constant	The speed detection noise is cut.
B30-5	Speed detection LPF time constant for ASR	Set the low path filter time constant used for the speed detection value input into the speed regulator.
B30-6	Speed detection LPF time constant for compensation	Set the low path filter time constant used for the speed detection value for constant output range compensation or iron loss compensation, etc.
B30-7	Torque current command setting LPF time constant	Set the low path filter time constant used for the torque current command.
B30-8	LPF time constant for drooping	Set the low pass filter time constant applied on the drooping value input into the speed regulator.

6-9 Adjusting the PM motor control system parameters

A PM motor with sensor can be controlled with the VT240S. The position detection (speed detection) option dedicated for PM motor operation is required for this. The control of PM motor with sensor has basically the same torque control functions as the IM vector control with sensor, so either ASR operation or ACR operation is possible.

The differences with the IM vector control are listed below.

IM vector control with sensor	PM motor vector control
Only the speed detection is required.	Position detection (rotary encoder) and speed detection option are required.
By controlling the exciting current, the induced electromotive force can be controlled.	The permanent magnet's flux is constant so the terminal voltage is controlled by passing a weak field current. Thus, the constant output range is narrow compared to IM.
DC braking is possible. Even when rotating with the load external force, the machine will stop at the position after movement.	The DC excitation state is established during DC braking. Thus, a torsion angle is generated according to the load torque. The original position is returned to when the load is removed.
The 3-phase inductance is equivalent.	The d axis and q axis inductance differs for the IPM (interior magnet type) motor.
During a no-load, the exciting current element current flows.	The current is approx. zero during a no-load. (When the weak field current control is not functioning.)
There is a time lag between the generation of the exciting current and the generation of the secondary flux, so the torque generation at starting is delayed.	The torque can be output simultaneously with the current generation at starting.
Even during the motor is running, the terminal voltage stays at zero even when the gate is cut off.	While the motor is rotating, an induced electromotive force is generated at the motor terminal even if the gate is cut off. When an overspeed is reached, a regenerative current is generated to the inverter and can cause an overvoltage.

Precautions for using PM motor

- (a) The current is approximately zero during the no-load. It cannot be determined that "the inverter is stopped because the ammeter reading is zero."
- (b) Even if the inverter "CHARGE" LED is not illuminated, motor terminal induced electromotive force occurs while the motor is rotating. There is a possibility of electric shock, and therefore always connect cables after the motor has come to a complete stop. If the speed is significantly higher than the base speed when driving from the load side, the power will be regenerated from the motor, the inverter DC voltage will increase, a voltage overload will occur, and the motor could break down. A mechanical brake or other such protective device is required when external operational torque is applied.

6. Control Functions and Parameter Settings

6-9-1 Initializing the parameters

Refer to the PM motor data sheet and set the parameters required for the PM motor control from the panel. All other settings must comply with section 6-8 vector control with sensor. Refer to the test operation section for the encoder settings (C50, C51).

No.	Parameter	Unit
A20 – ACR control constant (PM)		
0	ACR response (PM)	rad/s
1	ACR time constant (PM)	ms
2	d axis current command cushion time (PM)	ms/l1
3	q axis current command cushion time (PM)	ms/l1
B01 – Output rating (Vector control)		
1	Motor rated output (Vector control)	kW
2	No. of motor poles (Vector control)	Pole
3	Motor rated voltage (Vector control)	V
4	Max. speed (Vector control)	min ⁻¹
5	Motor rated frequency (Vector control)	min ⁻¹
6	Motor rated current (Vector control)	A
7	Carrier frequency (Vector control)	
8	No. of encoder pulses (Vector control)	P/R
9	No-load output voltage (Vector control)	V
B03 – Motor circuit constant (PM)		
0	R1: PM motor primary resistance (Mantissa section)	mΩ
1	R1: PM motor primary resistance (Exponent section)	
2	Ld: PM motor d axis inductance (Mantissa section)	mH
3	Lq: PM motor q axis inductance (Mantissa section)	mH
4	Ld, Lq: PM motor inductance (Exponent section)	
5	Rated torque electric current	%/l1
B13 – Local setting		
6	ASR gain compensation in constant power range	%
7	ACR gain compensation in constant power range	%
8	Linear torque limit (NTL1) (at 100% torque)	%
9	Linear torque limit (NTL2) (at 0% torque)	%

No.	Parameter	Unit
B35 – Voltage control constant (PM)		
0	Demagnetizing control operation voltage allowance (PM)	%/V1
1	Largest voltage setting (PM)	%/V1
2	Field weakening electric current limit value (PM)	%/V1
3	Demagnetizing current control proportional gain (PM)	
4	Demagnetizing current control integral time constant (PM)	ms
B36 – Field weakening electric current table (PM motor control)		
0	Field weakening electric current table 0 (PM) (at torque command 0%)	%/l1
1	Field weakening electric current table 1 (PM) (at torque command 25%)	
2	Field weakening electric current table 2 (PM) (at torque command 50%)	
3	Field weakening electric current table 3 (PM) (at torque command 75%)	
4	Field weakening electric current table 4 (PM) (at torque command 100%)	
5	Field weakening electric current table 5 (PM) (at torque command 125%)	
6	Field weakening electric current table 6 (PM) (at torque command 150%)	
C38 – Torque to Iq conversion adjustment coefficient table (PM)		
0	Torque to Iq conversion adjustment coefficient 0 (PM) (at Id command -100%)	%/l1
1	Torque to Iq conversion adjustment coefficient 1 (PM) (at Id command -75%)	
2	Torque to Iq conversion adjustment coefficient 2 (PM) (at Id command -50%)	
3	Torque to Iq conversion adjustment coefficient 3 (PM) (at Id command -25%)	
4	Torque to Iq conversion adjustment coefficient 4 (PM) (at Id command 0%)	
5	Torque to Iq conversion adjustment coefficient 5 (PM) (at Id command 25%)	
6	Torque to Iq conversion adjustment coefficient 6 (PM) (at Id command 50%)	

(Note) Parameters with a "%l1" unit must be set with a rate that corresponds to the rated current, and the "%/V1" parameters must be set with a ratio corresponding to the rated voltage.

6-9-2 PM motor control speed control system

The PM motor control speed control system is configured of the following types of blocks. Of these blocks, the speed control system and load torque observer section operate as the same functions as the IM vector control. Refer to section 6-8 for details on adjusting these parameters. Refer to section 6-8-8 for details on setting the various low path filters (B30-3 to 8).

The sections unique to the PM motor control are the weak field current control and torque current operation section following the torque command. These are adjusted by setting the parameter sheet data enclosed with the motor from the panel.

Note that as with the IM, the parameters related to the speed regulator, torque limiter, load torque observer and various low path filters differ according to the user's system, and ultimately must be adjusted according to the system in use.

PM speed control system block

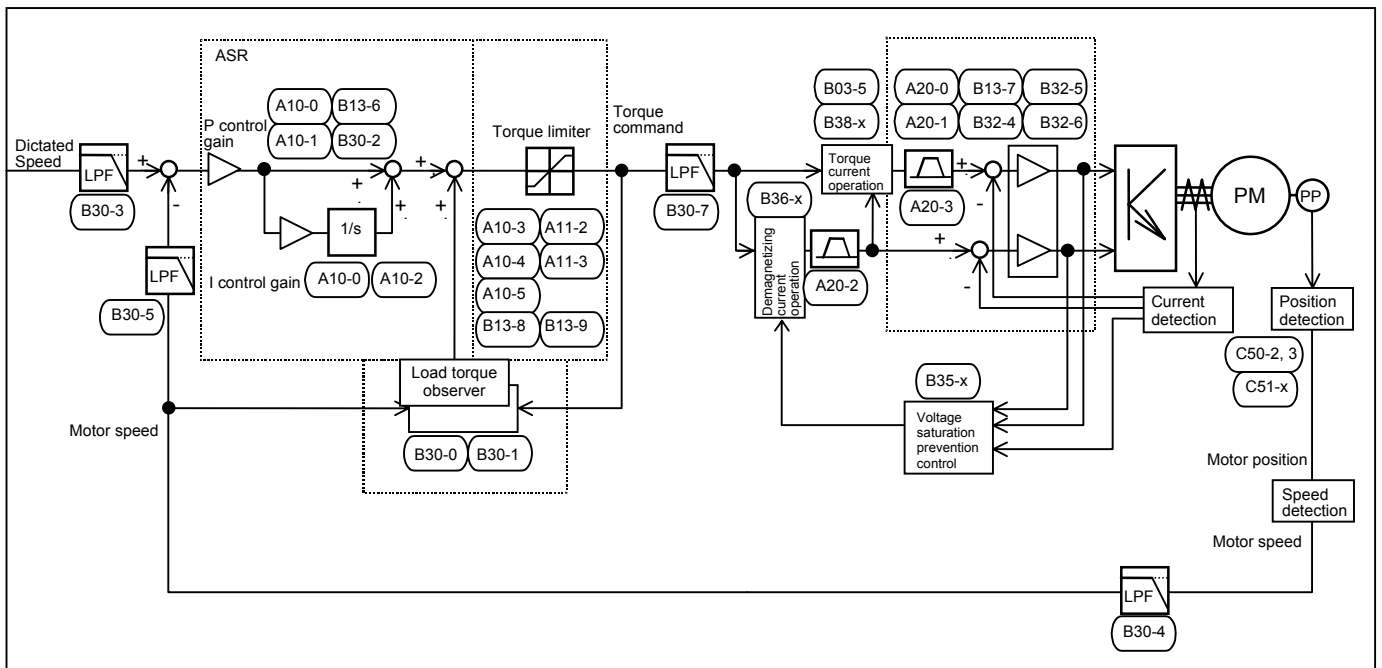

(Note) The numbers of the related parameters are indicated in the above function blocks.

6-9-3 Setting the PM motor circuit constants

The resistance and inductance elements are set as the PM motor circuit constants.

- (1) Set the value of one phase converted into a 3-phase & Y connection.
- (2) For the inductance element, set the value including the leakage inductance.
- (3) If the wiring path is long, add the wiring path resistance and inductance elements to the motor constant.

In the following wiring example, the set constants are calculated with the following expressions.

$$(B03-0,1) = R_{LINE} + R_1$$

$$(B03-2,4) = l_{LINE} + l_a + M_d$$

$$(B03-3,4) = l_{LINE} + l_a + M_q$$

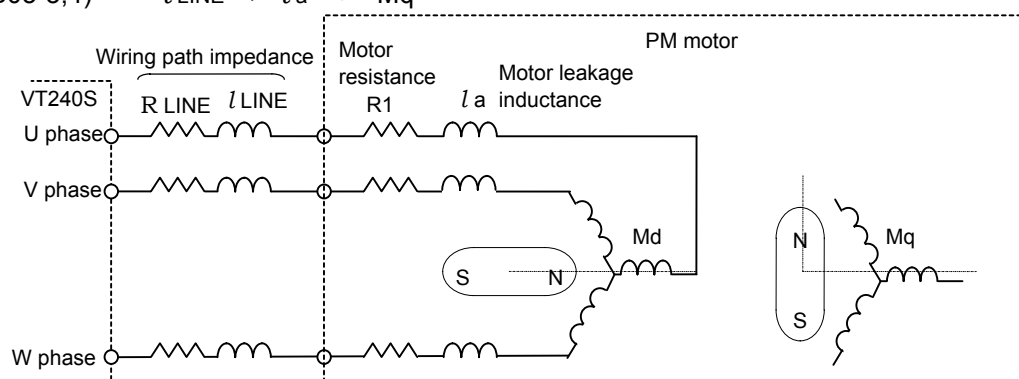

Fig. 6-9-3 PM motor and wiring path circuit constants

6-9-4 PM motor control current regulator

The PM motor control current regulator (ACR) is configured of the PI control, and has the following parameters.

Parameter No.	Parameter	Function
A20-0	ACR response (PM)	The ACR response radian frequency is set. Hunting at a several ms cycle will occur if the ACR response is too high. If the response is too low, the speed control system's gain cannot be set to a high value. Usually this should be set between 500 and 1500rad/s.
A20-1	ACR time constant (PM)	The ACR time constant is set. If the time constant is too long or too short, the current will become unstable, and the over current protection will function. Usually this should be set between 5 and 20ms.
B13-7	ACR gain compensation in constant power range	This sets the ACR P gain compensation value at the max. speed. Usually this should be set to 100% when using PM motor control.
B32-4	ACR voltage model FF selection	When using ACR feed forward compensation, set the setting value to 2, and set B32-5.
B32-5	ACR model voltage FF compensation	This is the compensation gain for the non-interference voltage element added to the ACR output. Use this when the operation frequency is high, or when the current control response is set to a high speed. Set a value of approx. 50 to 80%
B32-6	ACR proportional section dead time compensating factor	If the output frequency is 120Hz or more and an approx. 3ms cycle current vibration occurs, set a value between approx. 50 and 80%.

6-9-5 Torque limiter for PM motor

The output torque is limited. Refer to section 6-8-3 for details on the A10-3 to 5 and A11-2, 3 settings.

Parameter No.	Parameter
B13-8	Linear torque limit
B13-9	

With the PM motor, the weak field voltage range is narrow, and the voltage drop is large because of the armature's reaction. This causes the voltage to easily saturate when the speed increases or when the load is excessive. A linear torque limiter has been added to prevent this voltage saturation. As shown in Fig. 6-9-5-b, this functions simultaneously with the drive/regenerative torque limiter settings and variable torque function. The smaller value is used as the torque limiter value.

This linear torque limiter is set with the speed at 100% torque (B13-8) and speed at 0% torque (B13-9). Do not change the default values (B13-8=400%, B13-9=450%) when not using this linear torque limiter function. This limiter is valid even during IM vector control.

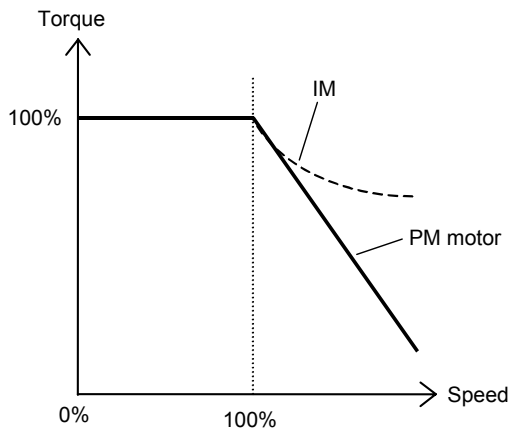

Fig. 6-9-5-a Torque characteristics of IPM motor

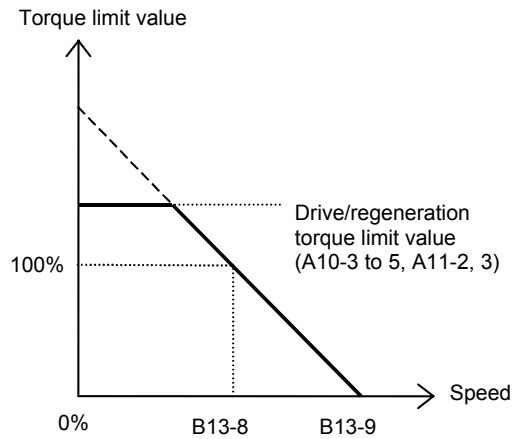

Fig. 6-9-5-b Linear torque limiter

6-9-6 Setting the weak field current pattern for the IPM motor

With the IPM (interior magnet type) PM motor with permanent magnet embedded in the iron core, the inductance has reverse salient-pole properties as indicated with $L_d < L_q$. With this type of motor, a large torque is generated with a small current by effectively using the reactance torque by passing a weak field current (negative direction current element for d axis).

The VT240S has a function to generate a weak field current according to the torque command. These characteristics are set as the table data (B36-0 to 6).

This setting value differs according to the motor design, so set a value which is appropriate for the motor being used. Set zero if the motor or servomotor characteristics are unclear, or when using an SPM (surface permanent magnet) motor.

Set this weak field current table with a panel using positive values. Even if the setting is a positive value, it will be converted into a negative d axis current command internally. Set a negative value to set a current on the magnetizing side. This table setting is valid only when the voltage saturation prevention control is not functioning. When the voltage saturation prevention control explained in the following section is functioning, the weak field current will be automatically increased so a weak field current larger than the characteristics set here will be generated.

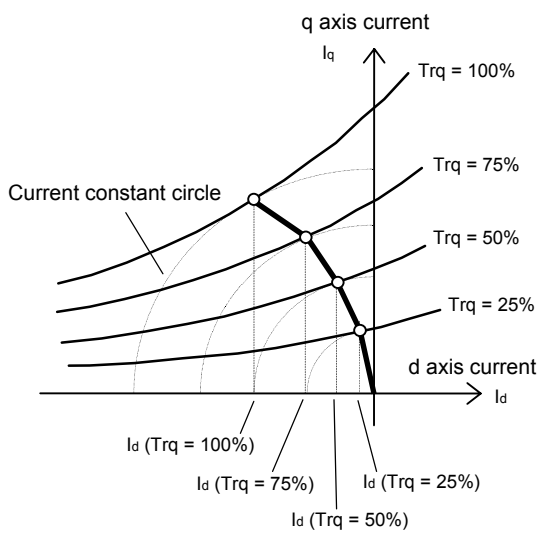

Fig. 6-9-6-a Relation of current vector and torque contour line

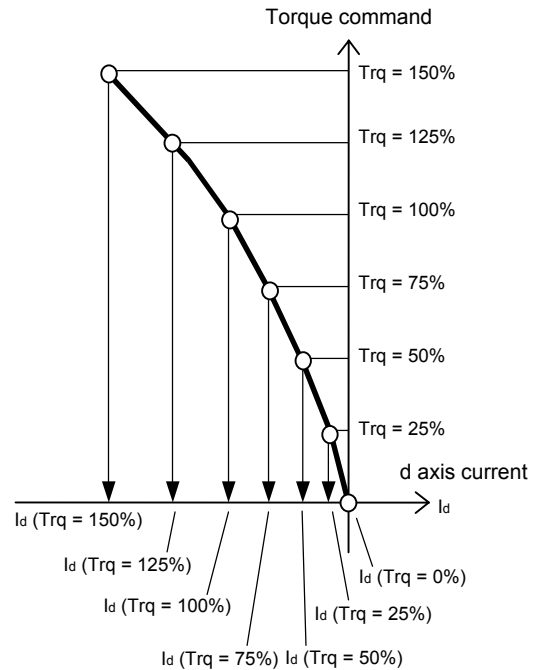

Fig. 6-9-6-b Weak field current table to be set

6-9-7 Setting the torque command and Iq current command conversion coefficient for the IPM motor

The relational expression of the torque (Trq) and d, q axis current (Id, Iq) which the IPM motor uses to generate the reactance torque from the weak field current is shown below.

$$I_q = \frac{Trq / (Pole/2)}{\phi_m - (L_q - L_d)I_d} = K_{T1} \cdot K_{T2}(I_d) \cdot Trq$$

Fig. 6-9-7-a shows these torque characteristics expressed on the Id-Iq axis. Two types of conversion coefficients K_{T1} (B03-5) and $K_{T2}(I_d)$ (B38-0 to 6) can be set with the VT240S to handle the changes in the torque characteristics caused by this type of weak field current.

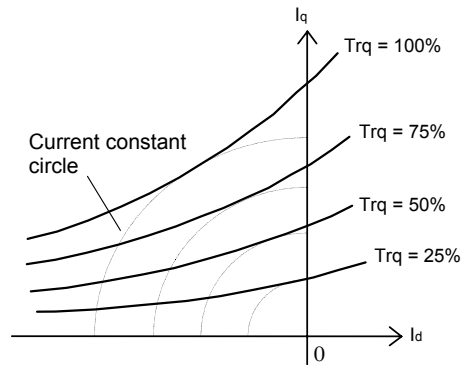

Fig. 6-9-7-a
Torque characteristics on IPM motor's Id-Iq axis

$K_{T2}(I_d)$ is a compensation coefficient which relies on Id. The value is set at the Id's 25% pitch. This compensation coefficient is linearly interpolated as shown in Fig. 6-9-7-b. If Id is outside of this table's range, the table's end setting value (B38-0, 6) is applied.

K_{T1} (B03-5) is a coefficient used for fine adjustment by increasing and decreasing the entire compensation pattern.

Set these parameters to value appropriate for the motor being used. When driving a motor for which the characteristics are unclear, set all parameters to the default values (B38-0 to 6=100%).

For the IPM motor, set the $K_{T-2}(I_d)$ compensation pattern with B38-0 to 6. Adjust B03-5 to finely adjust and increase or decrease this entire compensation pattern.

The SPM motor does not have a reactance torque, so set only B03-5. Leave B38-0 to 6 all at the default value (100%).

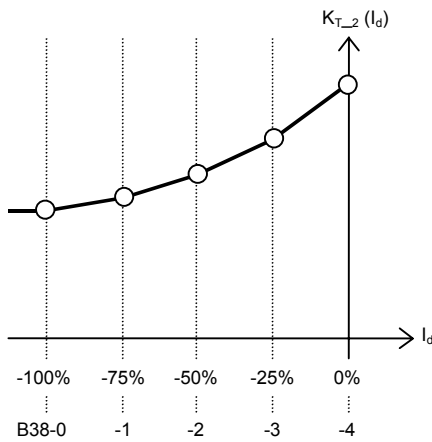

Fig. 6-9-7-b
Torque
→ Iq conversion coefficient table

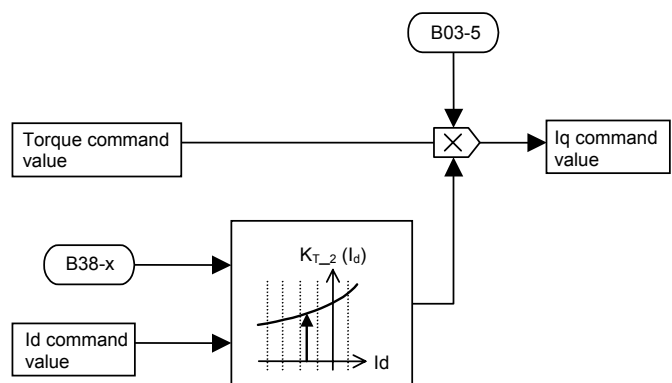

Fig. 6-9-7-c
Torque command
→ Iq command conversion block diagram

6-9-8 Operation of weak field in IPM motor constant output range

If the PM motor's speed increases, the terminal voltage increases, the inverter's maximum output voltage is reached, and the voltage is saturated. To prevent this voltage saturation, voltage saturation prevention control which automatically passes a weak field current (with reverse polarity of magnet's field flux) to suppress the terminal voltage is applied.

Set the following parameters to validate this function.

(B35-0) : This setting prevents the voltage saturation which occurs when the power voltage drops. The output voltage is limited to the value obtained by subtracting this setting value from the maximum output voltage corresponding to the power voltage.

(B35-1) : This setting prevents voltage saturation by suppressing the motor's terminal voltage to a set voltage or less. Normally, the motor's continuous maximum rated voltage (100%: default value) is set.

B35-0 and 1 are set as a ratio of the rated voltage.

The relation of B35-0 and B35-1 is shown below. Normally, the B35-1 setting value is the maximum value of the terminal voltage. However, if the DC voltage drops, the terminal voltage's maximum value is limited to the voltage level attained by subtracting the B35-0 setting value from the output voltage limit value. The weak field current is passed automatically so that the terminal voltage does not exceed that maximum value. Thus, the current control system functions properly even if the motor speed increases or the DC voltage drops.

(B35-2) : Set the maximum limit value (limit value on Id negative side) for the weak field current generated to prevent voltage saturation as a ratio in respect to the rated current. The magnet could be demagnetized (irreversible demagnetization) if an excessive weak field current is passed. This setting prevents this demagnetization.

(B35-3, 4): Set the proportional gain and time constant for the voltage saturation prevention control.

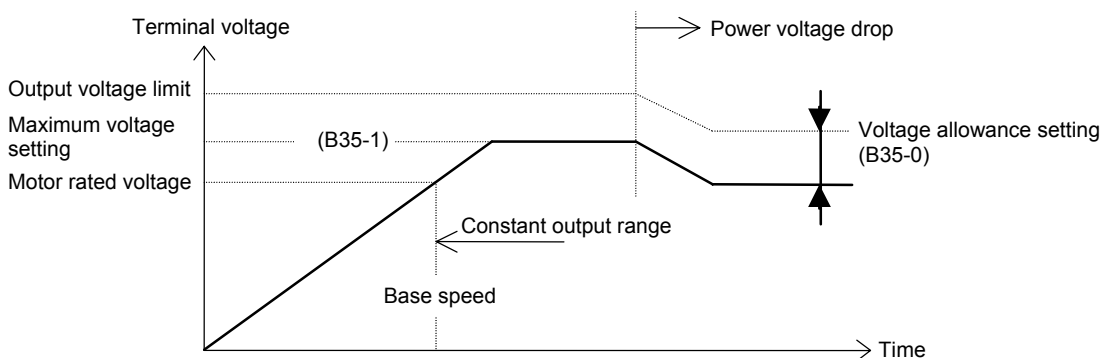

Fig. 6-9-8 Output voltage limit operation in constant output range

6-10 Operating the auxiliary drive motor

With the VT240S, a main drive motor operated with the C30-0:f0 control mode and an auxiliary drive motor operated with V/f control can be run by switching the internal control using the external sequence input AUXDV (auxiliary drive selection) and AUXSW0 and AUXSW1 (auxiliary drive No. selection). The main drive motor and auxiliary drive are switched with the sequence input AUXDV. The auxiliary drive number is switched with AUXSW0 and AUXSW1.

6-10-1 Switching the main and auxiliary drive motor control

The inverter's internal main drive motor control and auxiliary drive motor control is switched with the external sequence input AUXDV. However, the control must be switched while the motor is stopped. If the auxiliary drive selection signal is switched while the inverter is running, the switch will be invalid and instead will switch to the control corresponding to the signal status when the inverter stops. When switching the control, the sequence output RDY1 and RDY2 (READY) turn OFF, and the inverter operation is prohibited. The state of the inverter internal control switching can be confirmed with the sequence output AUXDV (auxiliary drive selection).

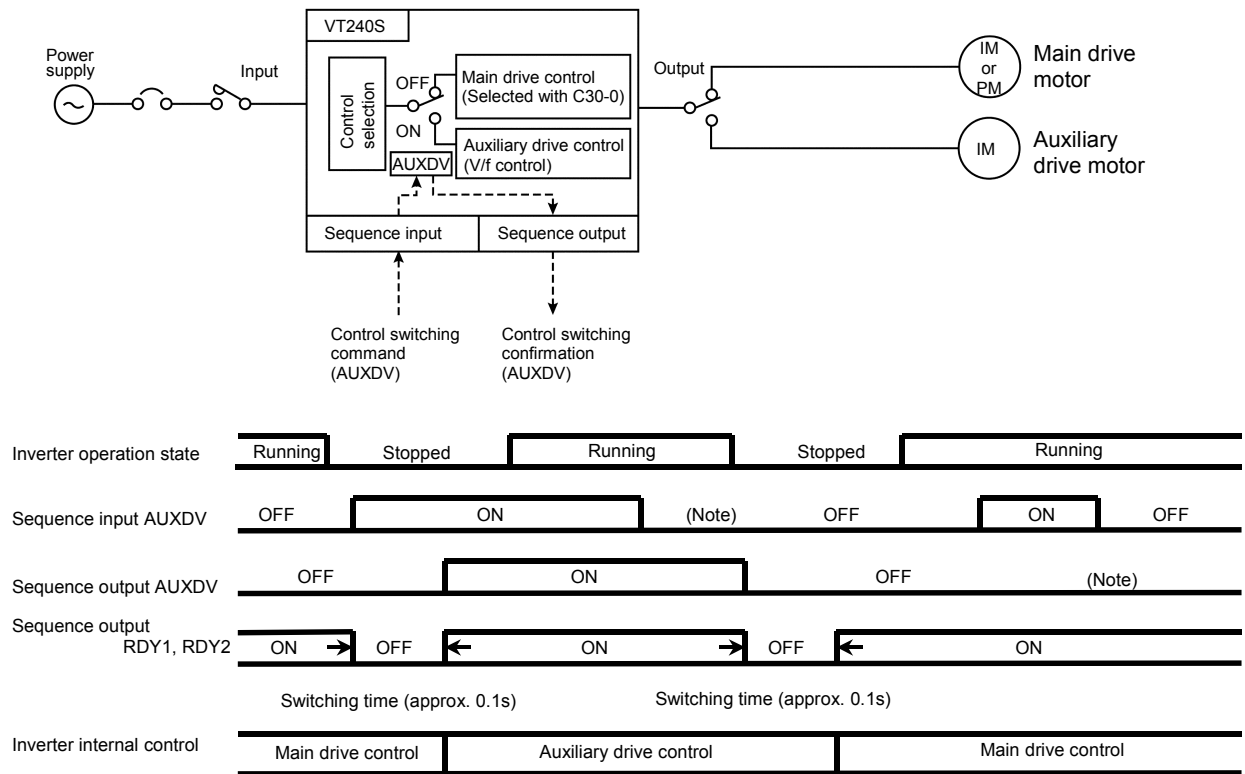

(Note) The main and auxiliary drive motor control cannot be switched while the inverter is running. The drive switches to that corresponding to the sequence input AUXDV status when the motor stops.

Switching of main drive motor control and auxiliary drive motor control

6-10-2 Switching control between auxiliary drive motors

The VT240S has four auxiliary drive operation control parameters No. 0 to 3. No. 0 is valid in the default state. The auxiliary drive number is switched with the external sequence input AUXSW0 and AUXSW1. The inverter must be stopped when switching.

If AUXSW0 or AUXSW1 is changed while the inverter running, the switch will be invalid, and instead will switch to the No. corresponding to the signal status when the inverter stops.

AUX SW1	AUX SW0	Auxiliary drive No.	Corresponding parameters
L	L	0	B20-0 to B23-4
L	H	1	B24-0 to B27-4
H	L	2	B28-0 to B2B-4
H	H	3	B2C-0 to B2F-4

Relation of sequence input AUXSW0, AUXSW1 and auxiliary drive No., and applicable parameters

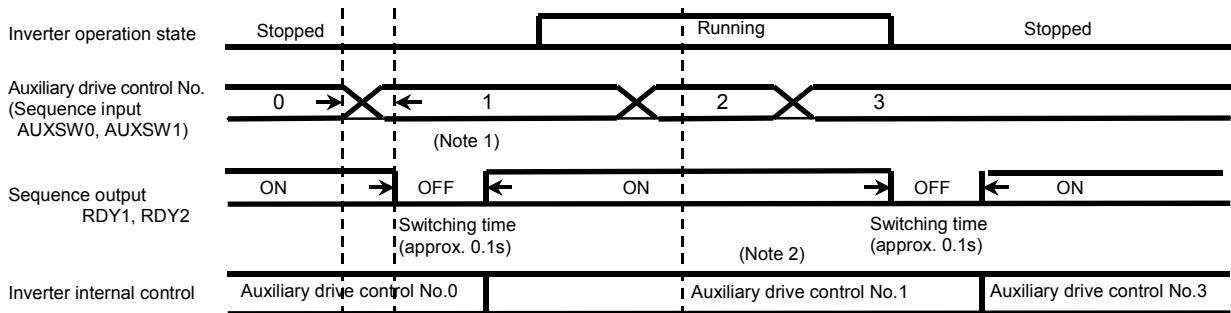

(Note 1) After switching to sequence input AUXSW0 or 1, a delay of 500ms will be applied before the drive No. is switched internally.

(Note 2) Auxiliary drive No. switching is invalid while the inverter is running. The auxiliary drive will switch to the number corresponding to the status of AUXSW0 or AUXSW1 when the inverter stops.

Switching control between auxiliary drive motors

6. Control Functions and Parameter Settings

6-10-3 Auxiliary drive motor control related parameters

The dedicated parameters for auxiliary drive motor control are shown below.

Dedicated parameters for auxiliary drive motor
(When auxiliary drive No. is set to 0)

No.	Parameter
B20-0 to 5	Output rating (Auxiliary drive 0)
B20-6, 7	Start/Stop frequency (Auxiliary drive 0)
B20-8, 9	Upper/Lower limit (Auxiliary drive 0)
B21-0, 1	Frequency setting (Auxiliary drive 0)
B21-2 to 7	Acceleration/deceleration time (Auxiliary drive 0)
B22-0, 1	Torque boost (Auxiliary drive 0)
B22-2, 3	DC brake (Auxiliary drive 0)
B22-4 to 6	Over current limit (The parameters B18-3~6 are shared with the main drive motor control) (Auxiliary drive 0)
B22-7 to 9	Overload reference (Auxiliary drive 0)
B23-0 to 4	Braking on power deceleration ramp time (Auxiliary drive 0)

6-10-4 Functions and settings that cannot be used during auxiliary drive motor control

As opposed to V/f control (C30-0: f0-1) during main drive motor control, some functions cannot be used with auxiliary drive motor control.

Function and setting that cannot be used	Related parameter and sequence input
Automatic torque boost	A02-4 to 6
Frequency skip	B05-0 to 5
Ratio interlock	B06-0 to 3
V/F middle point	B17-0 to 3
Frequency increment/decrement	C04-7, 8 (Sequence input FUP/FDW)
Interlock ratio bias increment/decrement	C04-9 to B (Sequence input BUP/BDW/IVLM)
Automatic tuning	B19-0
Primary resistance	B02-0 to 1 (Dedicated for main drive motor)
Control mode selection	C30-0 (Dedicated for main drive motor)

6-11 Built-in PLC Function

The VT240S has a built-in PLC function. The sequence can be input/output and the analog signals can be input/output with this function. The built-in PLC function has the following features.

- A programmable sequence function is provided in the inverter.
- Commands are input with a command format based on the instruction codes.
- Commands can be input from the operation panel. This allows changes to be made easily at the site.
- Commands can be input with the standard serial. Command generation support software is under development.

6-11-1 Outline explanation of processing system

The built-in PLC function runs with the processing system shown in Fig. 6-11-1.

The interpreter section runs at a 2ms interval, so operations can be carried out at the same sample cycle as the regular inverter process. The commands are separated in units called "banks", and one bank is executed at a 2ms interval. The number of banks to be executed can be set with U10-0 (No. of executed banks), so if the process is heavy, it can be split into five banks and executed at a 10ms interval.

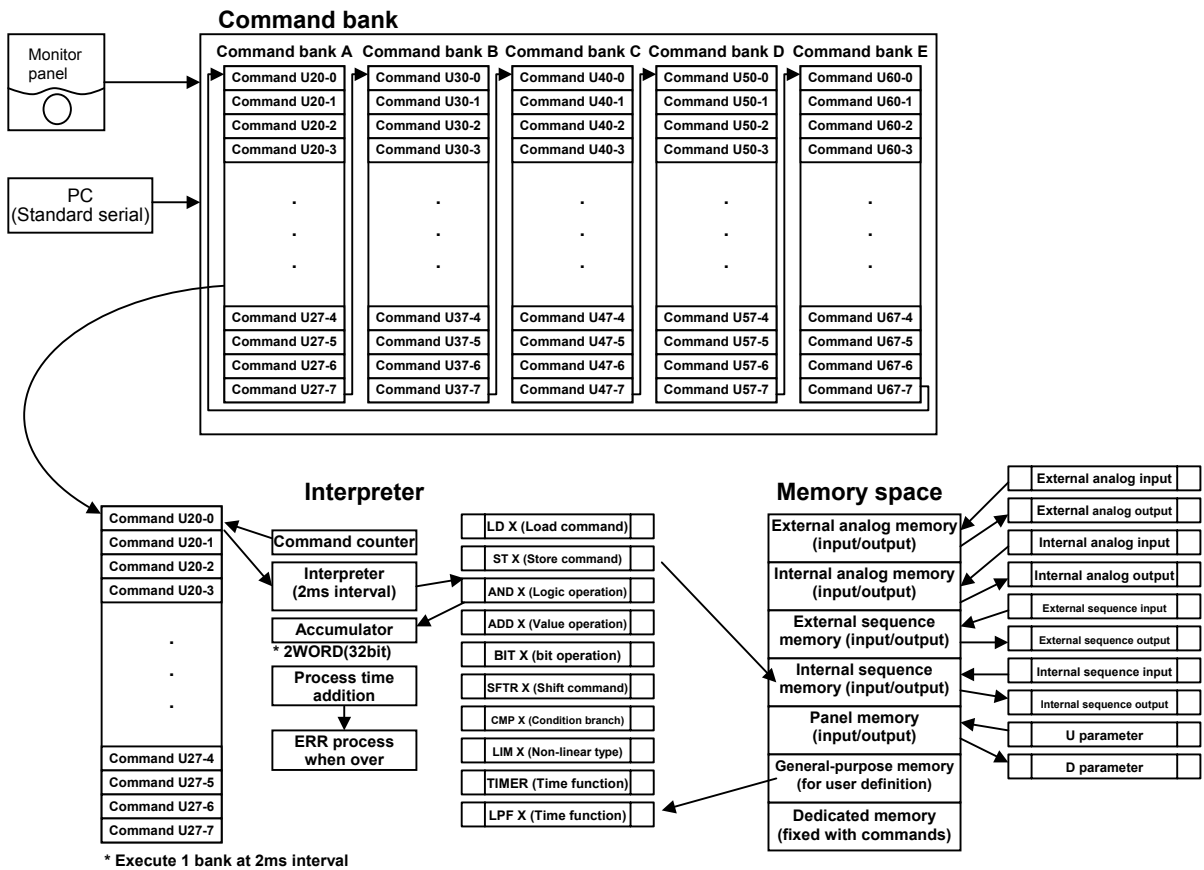

Fig. 6-11-1 Built-in PLC processing system

The built-in PLC reads the commands from the command bank. The command is then interpreted by the interpreter section, and then executed. Each command is operated using a 32-bit general-purpose accumulator and 16t-bit width memory space. Some commands are handled as 16 bits, and some are expanded to 32 bits and handled.

The built-in PLC function carries out the operation in the inverter, so some limits apply to the operation time. Each command is assigned a step count as the execution time. The interpreter increments the step count each time a command is executed. If the incremented step count value exceeds a set value (1280 steps) within a 2ms interval, the CPU-B will stop with a fault. In this case, review the command, and reset the number of steps executed with one bank so that it is smaller than the set value. If the CPU-B fails, the command bank execution number will be forcibly reset to 0. Reset the power to restart the built-in PLC function.

6-11-2 Related parameters

The parameters related to the built-in PLC are listed below. The memory numbers are explained later.

- (1) Panel display (D10-0 to 3): Built-in PLC → Display
Four values can be displayed in parameters D10-0 to 3. To display, write the values in memory numbers 32h to 35h.
- (2) Sequence input (C03 to C06): Built-in PLC → Inverter
The signals from the built-in PLC can be connected as sequence inputs.
The low-order 4 bits of memory No. 28h are PL1 to 4.
- (3) Analog input (C07): Built-in PLC → Inverter
The signals from the built-in PLC can be connected as analog inputs.
The four words in memory No. 24h to 27h are output as the built-in PLC outputs 1 to 4 (set C07 between 8 and 11).
- (4) Analog output (C13-0, 1): Built-in PLC → Analog output
Analog outputs are possible from the built-in PLC.
The four words in memory No. 24h to 27h are output as the built-in PLC outputs 1 to 4 (set C07 between 8 and 11).
- (5) Sequence output (C13-2 to 6): Built-in PLC → Sequence output
Sequence output is possible from the built-in PLC.
The low-order 8 bits of memory No. 28h are PLC1 to 8.
- (6) Analog input selection (C13-7 to A): Inverter → Built-in PLC
The inverter output analog signals can be input to the built-in PLC.
Select the details set in memory numbers 10h to 13h.
- (7) No. of Built-in PLC execution banks (U10-0)
Set the number of banks to be executed with the built-in PLC.
- (8) Built-in PLC parameter (U10-1 to 7): Parameter → Built-in PLC
Eight parameters can be input.
The details set with the parameters are set in memory numbers 2Ah to 31h.
- (9) Built-in PLC command (U20 to U67)
Input the commands executed with the built-in PLC.

6. Control Functions and Parameter Settings

6-11-3 Memory space

The memory space used with the built-in PLC is shown below. The memory No. is indicated with a hexadecimal.

Memory No.	Name	Details	Unit	Read/ write
0	External analog input 1	Reads input value from AI0	1000h=100%	Read
1	External analog input 2	Reads input value from AI1	1000h=100%	Read
2	External analog input 3	Reads input value from AI2	1000h=100%	Read
5	External serial input 1	Reads serially set speed command	1000h=100%	Read
6	External serial input 2	Reads serially set torque command	1000h=100%	Read
7	External serial input 3	Reads serially set torque ratio 1	1000h=100%	Read
8	External serial input 4	Reads serially set torque bias	1000h=100%	Read
9	External serial input 5	Reads serially set torque ratio 2	1000h=100%	Read
A	External serial input 6	Reads serially set drive torque limiter	1000h=100%	Read
B	External serial input 7	Reads serially set regenerative torque limiter	1000h=100%	Read
C	External serial input 8	Reds serially set ASR response	0.1r/s/LSB	Read
D	External serial input 9	Reads serially set machine time constant	1ms/LSB	Read
10	Internal analog output 1	Reads output value selected with C13-7	1000h=100%	Read
11	Internal analog output 2	Reads output value selected with C13-8	1000h=100%	Read
12	Internal analog output 3	Reads output value selected with C13-9	1000h=100%	Read
13	Internal analog output 4	Reads output value selected with C13-A	1000h=100%	Read
14	External sequence input 1	Reads state set with terminal block	–	Read
18	External sequence input 5	Reads serially set status	–	Read
19	External sequence input 6	Reads serially set status	–	Read
1A	External sequence input 7	Reads serially set status	–	Read
1B	External sequence input 8	Reads serially set status	–	Read
1C	Internal sequence output 1	Reads inverter sequence output (D04-4)	–	Read
1D	Internal sequence output 2	Reads inverter sequence output (D04-5)	–	Read
1E	Internal sequence output 3	Reads inverter sequence output (D04-6)	–	Read
1F	Internal sequence output 4	Reads inverter sequence output (D04-7)	–	Read
20	Internal sequence output 5	Reads inverter alarm output (D05-0)	–	Read
24	Analog output 1	Writes value output with C13-0/1 = 16	1000h=10V	Write
25	Analog output 2	Writes value output with C13-0/1 = 17	1000h=10V	Write
26	Analog output 3	Writes value output with C13-0/1 = 18	1000h=10V	Write
27	Analog output 4	Writes value output with C13-0/1 = 19	1000h=10V	Write
28	Sequence output	Writes PLC0 to PLC7 output with C13	–	Write
2A	Panel parameter 1	Reads value set with U10-1	–	Read
2B	Panel parameter 2	Reads value set with U10-2	–	Read
2C	Panel parameter 3	Reads value set with U10-3	–	Read
2D	Panel parameter 4	Reads value set with U10-4	–	Read
2E	Panel parameter 5	Reads value set with U10-5	–	Read
2F	Panel parameter 6	Reads value set with U10-6	–	Read
30	Panel parameter 7	Reads value set with U10-7	–	Read
31	Panel parameter 8	Reads value set with U10-8	–	Read
32	Panel display 1	Writes value displayed with D10-0	–	Write
33	Panel display 2	Writes value displayed with D10-1	–	Write
34	Panel display 3	Writes value displayed with D10-2	–	Write
35	Panel display 4	Writes value displayed with D10-3	–	Write
40 to 5F	User memory	Memory which can be read/write freely	–	r/w
60 to 9F	Dedicated memory	Dedicated memory used by commands	–	r/w
A0 to C0	Constant memory	0 to 32d values are loaded at start up	–	Read

* The memory numbers other than those listed above are for future use.

6. Control Functions and Parameter Settings

- * The external analog input is a full scale 100% when the gain is 1.0.
- * The internal analog output unit differs according to the set parameter. However, it is 100% at the maximum or rated display value explained in C13. 10V = 100% conversion applies to the OLT monitor and heat sink temperature.
(The output frequency is 100% at the maximum frequency, and the motor rated current is 100% at the rated current.)

- * The following bit assignments apply to the external sequence input 1.

bit0 : Not used	bit4 : PSI4	bit8 : PSI8	bit12: PSI12
bit1 : PSI1	bit5 : PSI5	bit9 : PSI9	bit13: PSI13
bit2 : PSI2	bit6 : PSI6	bit10: PSI10	bit14: PSI14
bit3 : PSI3	bit7 : PSI7	bit11: PSI11	bit15: PSI15

- * The following bit assignments apply to the external sequence inputs 5 to 8.

External sequence input 5

bit0 : EMS	bit4 : FJOG	bit8 : HOLD	bit12: IPASS
bit1 : RST	bit5 : RJOG	bit9 : BRKAE	bit13: CPASS
bit2 : FRUN	bit6 : EXC	bit10: COP	bit14: AI1
bit3 : RRUN	bit7 : Not used	bit11: CSEL	bit15: AI2

External sequence input 6

bit0 : AI3	bit4 : S1	bit8 : FUP	bit12: IVLM
bit1 : PROG	bit5 : S2	bit9 : FDW	bit13: AUXDV
bit2 : CFS	bit6 : S3	bit10: BUP	bit14: PICK
bit3 : S0	bit7 : SE	bit11: BDW	bit15: Not used

External sequence input 7

bit0 : Not used	bit4 : LIM2	bit8 : DEDB	bit12: Not used
bit1 : ACR	bit5 : MCH	bit9 : TRQB1	bit13: Not used
bit2 : PCTL	bit6 : RF0	bit10: TRQB2	bit14: Not used
bit3 : LIM1	bit7 : REG	bit11: Not used	bit15: Not used

External sequence input 8

bit0 : DBRK	bit4 : S6	bit8 : PLS_IN	bit12: Not used
bit1 : SRST	bit5 : S7	bit9 : OCLLV1	bit13: Not used
bit2 : PID	bit6 : AUXSW0	bit10: OCLLV2	bit14: Not used
bit3 : S5	bit7 : AUXSW1	bit11: Not used	bit15: Not used

- * For the internal sequence output, the bottom of the display (D04-4 to 7) is the low-order bit, and the top is the high-order bit.

- * The following bit assignments apply to the sequence output.

bit0 : PLC1	bit4 : PLC4	bit8 : Not used	bit12: Not used
bit1 : PLC2	bit5 : PLC5	bit9 : Not used	bit13: Not used
bit2 : PLC3	bit6 : PLC6	bit10: Not used	bit14: Not used
bit3 : PLC4	bit7 : PLC7	bit11: Not used	bit15: Not used

6. Control Functions and Parameter Settings

6-11-4 Commands

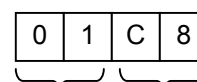

The commands used with the built-in PLC are a 4-digit value. The commands can be input to the built-in PLC by inputting a 4-digit value in the U20 to U67 parameters.

Command No. Memory No.

The built-in PLC follows the command No. and executes the command using the memory No. X (16-bit) and accumulator A (32-bit). The accumulator is a 32-bit general-purpose register. Most of the commands are passed through the accumulator and operated.

The commands are listed below. Command No. 00 is the bank end command. The built-in PLC executes the commands in order from the head of the command bank. When the command reaches 00, execution of the current command bank is stopped. When the next 2ms interval is reached, the next command bank is executed from the head. If there is no X in the details of each command, the memory No. is random (not used).

List of built-in PLC commands

No.	Command	Details	Expression indication	No. of steps
00h	NOP	Nothing is executed. End of bank.	None	0
01	LD	X is loaded with sign extended to A.	A=X	28
02	LD_U	X is loaded without encoding A.	A=X	28
03	LD32	X (i) and X (i+1) are loaded as 32 bits.	A=X	43
04	ST_L	Low-order 16 bits of A are stored in X.	X=(short)A	27
05	ST_H	High-order 16 bits of A are stored in X.	X=(short)(A>>16)	28
06	ST32	A is stored in X (i) and X (i+1) as 32 bits.	X=A	44
07	BIT	A's X bit is obtained.	A=(A & bit X)>>X	58
08	SFT_R	A is shifted to the right by X bit. (With sign extension)	A=A>>X	Shift No.* 18+46
09	SFT_L	A is shifted to the left by X bit. (With sign extension)	A=A<<X	Shift No.* 18+46
0B	ADD	X is added to A.	A=A+X	32
0C	ADD32	X (i) and X (i+1) are added to A as 32 bits.	A=A+X	47
0D	SUB	X is subtracted from A.	A=A-X	32
0E	SUB32	X (i) and X (i+1) are subtracted from A as 32 bits.	A=A-X	47
0F	MUL_L	A is multiplied by X. (Low-order 32 bits are obtained)	A=A*X	60
10	MUL_H	A is multiplied by X. (High-order 32 bits are obtained)	A=(A*X)>>16	63
11	DIV	A is divided by X.	A=A/X	126
15	AND	AND of A and X is obtained and saved in A.	A=A&X	35
16	OR	OR of A and X is obtained and saved in A.	A=A X	35
17	XOR	XOR of A and X is obtained and saved in A.	A=A^X	35
18	NOT	NOT of A is saved in A	A= \bar{A}	20
1F	CMP_EQ	If A=X, A=1. In all other cases A=0.	A=(A==X)	40
20	CMP_NE	If A!=X, A=1. In all other cases A=0.	A=(A!=X)	40
21	CMP_GT	If A>X, A=1. In all other cases A=0.	A=(A>X)	40
22	CMP_LT	If A<X, A=1. In all other cases A=0.	A=(A<X)	40
23	CMP_GE	If A≥X, A=1. In all other cases A=0.	A=(A>=X)	40
24	CMP_LE	If A≤X, A=1. In all other cases A=0.	A=(A<=X)	40
25	JMP	X is added to command pointer unconditionally.		18
26	JMPC	If A!=0, X is added to command pointer.	* Other than 0	39
27	JMPC	If A=0, X is added to command pointer.		39
28	NEG	A is inverted to -A.	A=-A	20
29	ABS	Absolute value of A is obtained.	A=ABS(A)	26
2A	LIM_G	If A is signed and A>X, then limit to X	If (A > X) A=X	50
2B	LIM_L	If A is signed and A<X, then limit to X	If (A < X) A=X	50

6. Control Functions and Parameter Settings

No.	Command	Details	Expression indication	No. of steps
2E	TIMER1	Count up when input [64] is not 0. If counter [65] is higher than level [66], then output [67]=1 If input [64] is 0, and reset counter [65]	Input : 64 Counter : 65 Level : 66 Output : 67	48
2F	TIMER2	Same as TIMER1	Input : 68 Counter : 69 Level : 6A Output : 6B	48
30	TIMER3	Same as TIMER1	Input : 6C Counter : 6D Level : 6E Output : 6F	48
31	TIMER4	Same as TIMER1	Input : 70 Counter : 71 Level : 72 Output : 73	48
32	LPF1	Use accumulator as input, and execute LPF process with X gain. Output is accumulator.	Input : Acc Gain : X Buffer : [74, 75] Output : Acc	77
33	LPF2	Use accumulator as input, and execute LPF process with X gain. Output is accumulator.	Input : Acc Gain : X Buffer : [76, 77] Output : Acc	77
34	LPF3	Use accumulator as input, and execute LPF process with X gain. Output is accumulator.	Input : Acc Gain : X Buffer : [78, 79] Output : Acc	77
35	LPF4	Use accumulator as input, and execute LPF process with X gain. Output is accumulator.	Input : Acc Gain : X Buffer : [7A, 7B] Output : Acc	77

* A refers to the accumulator (32-bit) and X (16-bit) refers to the general memory or dedicated memory.

* If there is no X in the details of each command, the memory No. is random (not used).

* Unless indicated, the commands are handled as signed extensions.

6-11-5 Usage examples

Examples of using the built-in PLC are shown below.

(1) Operation interlock

Specifications)

The operation command (RUN) is interlocked with the external sequence input (PSI)

- Details)
- 1) Input the run command to PSI1
 - 2) Input the interlock signal to PSI2
 - 3) Output the PSI1 and PSI2 AND signal to PLC1
 - 4) Use PL0 as the RUN command

Parameters)

- 1) C03-0=12 (PSI1 is used for the run command so disconnected, and connect RUN command and PL0)
- 2) C03-7=0 (PSI2 is used for interlock signal, so disconnect from RESET)

Setting the commands)

- 1) U20-0=0114: Load external sequence input 1 to accumulator.
- 2) U20-1=08A1: Shift accumulator one bit to the right. (Use fixed memory A1)
- 3) U20-2=1514: Obtain AND of accumulator and external sequence input 1
- 4) U20-3=07A1: Obtain bit 1 of accumulator (Use fixed memory A1)
- 5) U20-4=0428: Write accumulator to sequence output (PLC1)
- 6) U20-5=0000: End of bank

Setting the number of execution banks)

- 1) U10-0=1: Set the number of executed bans to 1 (bank A only)

Note) Set the number of execution banks after all settings have been completed. Failure to observe this could result in unexpected operations.

6-12 Explanation of standard serial and Modbus communication

The VT240S is equipped with a serial transmission function using RS485 as a standard. The inverter can be controlled with a host computer using this function.

Either the Modbus network with Modbus protocol or the VT240S series original communication protocol standard serial communication can be selected with the parameters.

6-12-1 Connection method

This network is configured of one host computer (master) and 1 to 32 VT240S units (slaves).

CN2 (connector type: modular) on the basic section or TB3 is used for the connection.

Refer to section 2-4. Precautions for wiring the control signal for details on CN2 and TB3, and for the wiring methods.

The total length of the connected cable must be within 150 meters.

By using a commercially-available RS485-RS232C converter or USB converter unit as a relay, the inverter can be connected to a host computer equipped with a serial port or USB, such as a commercially-available personal computer.

• Connecting the host computer and VT240S (1-on-1)

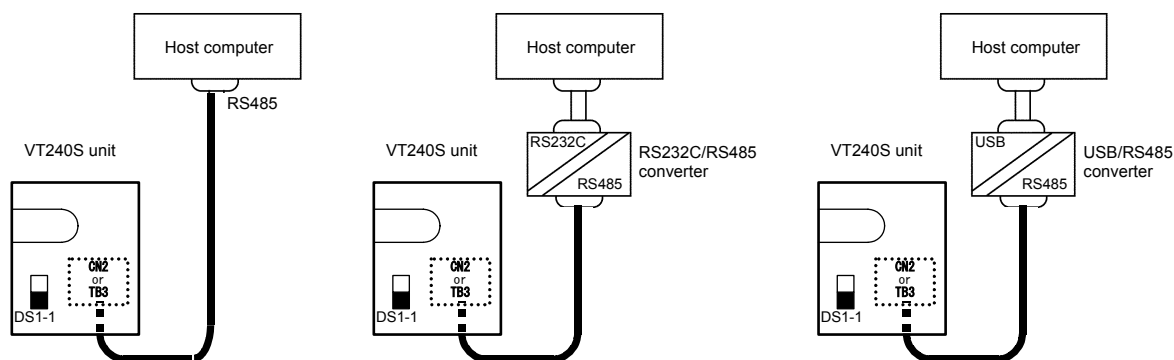

⚠ CAUTION

- Do not connect both CN2 and TB3 to the host computer.
- CN2 is an RJ11 (4-pole, 4-core) connector. Pay attention to the number of poles, and prepare the cable and connector.
- Separates the communication cable from the main circuit cable and other power cables.
- A shielded twisted pair cable should be used for connecting TB3 and the host computer. Connect the shielded twisted pair cable's shield to the TB3 SG.
- When using a 1-on-1 connection, set the inverter's resistance (DS1 No. 1 switch on basic section) to the 120Ω side.
- When connecting the TB3 and shielded twisted pair cable, do not solder the wires which are exposed after the sheath is peeled off.
- If the communication is distorted and not carried out properly because of noise, etc., connect a ferrite core, etc., to the cable, and increase the noise resistance.

6. Control Functions and Parameter Settings

When connecting several VT240S units, connect two wires to each TB3 terminal, and couple the VT240S units.

An example of the connection is shown below.

- **Connecting the host computer and VT240S (connecting several units)**

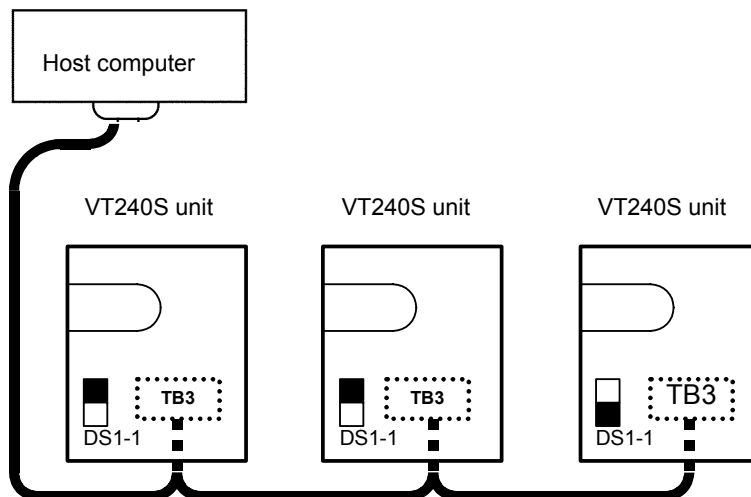

The details of the TB3 terminal section are shown below.

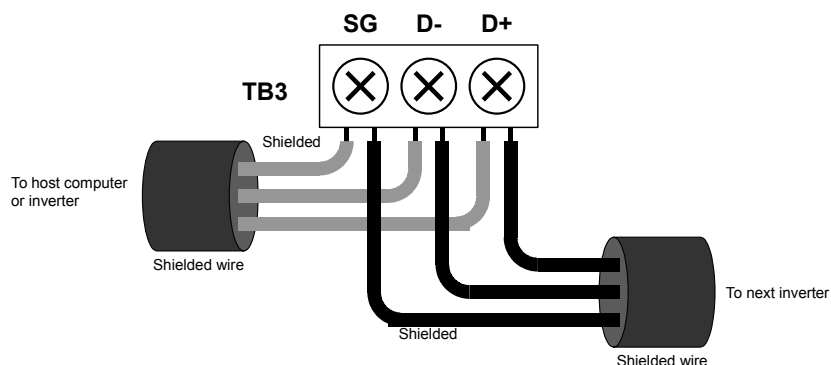

CAUTION

- Separates the communication cable from the main circuit cable and other power cables.
- A shielded twisted pair wire should be used for connecting TB3 and the host computer. Connect the twisted pair cable's shield to the TB3 SG.
- When using several slave units, set the resistance (DS1 No. 1 switch on basic section) of the last inverter to 120Ω.
- When connecting the TB3 and shielded twisted pair cable, do not solder the wires which are exposed after the sheath is peeled off.
- If the communication is distorted and not carried out properly because of noise, etc., connect a ferrite core, etc., to the cable, and increase the noise resistance.

6. Control Functions and Parameter Settings

6-12-2 Communication specifications

Item	Specification
Connection method	RS485, 2-wire type
Transmission distance	Total extension distance: 150m
Baud rate	Select from 4800, 9600, 14400, 19200, 38400bps
Transmission method	Start-stop synchronization, half-duplex communication
Frame configuration	Start : 1 bit Data : 8 bits Stop : Select from 1 bit or 2 bits Parity : Select from none, odd or even
Error detection	Sum check, parity, framing
Transmission code	8-bit binary or ASCII
Communication protocol	Select from Modbus-RTU communication or standard serial communication
Number of stations	Set between 1 and 32

The factory settings are shown below.

Communication protocol : Standard serial communication
Baud rate : 9600bps
Frame configuration : Start: 1bit, Data: 8bit, Stop: 2bit, Parity: odd, Station No.: 01

6-12-3 Procedures for enabling communication with host controller

The communication parameters must be set to enable communication with the host controller.

The procedure is given below.

- (1) Select C26-0, and select the communication method.
Example: C26-0=1: Select standard serial communication.
- (2) Select the station No.
Example: C26-2=18
- (3) Set the baud rate.
Example: C26-4=5: 38400bps
- (4) Set the number of stop bits.
Example: C26-5=1: Stop bit 1 bit
- (5) Set the parity.
Example: C26-6=1: No parity
- (6) After completing the settings, turn the power OFF once. When the control power has turned OFF, turn the power ON again.

6. Control Functions and Parameter Settings

Communication with the set communication method is now possible.
An excerpt of the parameter C26 setting details is given below.

No.	Parameter	Unit	Default	Min.	Max.	Function																																								
C26 – Standard serial transmission setting																																														
0	Function selection		0.	0.	1.	0: Standard serial 1: MODBUS																																								
1	Parameter change protection		1.	1.	5.	<p>The parameters with a ○ mark below can be changed.</p> <table border="1" style="margin-left: 20px;"> <thead> <tr> <th rowspan="2">Set-ting value</th> <th rowspan="2">Block A Para-meter</th> <th colspan="4">Block B, C Parameter</th> </tr> <tr> <th>Basic</th> <th>Extend</th> <th>S/W</th> <th>H/W</th> </tr> </thead> <tbody> <tr> <td>1</td> <td>○</td> <td>○</td> <td>○</td> <td>○</td> <td>○</td> </tr> <tr> <td>2</td> <td>×</td> <td>×</td> <td>×</td> <td>×</td> <td>×</td> </tr> <tr> <td>3</td> <td>○</td> <td>×</td> <td>×</td> <td>×</td> <td>×</td> </tr> <tr> <td>4</td> <td>○</td> <td>×</td> <td>○</td> <td>×</td> <td>×</td> </tr> <tr> <td>5</td> <td>○</td> <td>×</td> <td>○</td> <td>○</td> <td>×</td> </tr> </tbody> </table> <p style="margin-left: 20px;">○: Changeable ×: Unchangeable</p>	Set-ting value	Block A Para-meter	Block B, C Parameter				Basic	Extend	S/W	H/W	1	○	○	○	○	○	2	×	×	×	×	×	3	○	×	×	×	×	4	○	×	○	×	×	5	○	×	○	○	×
Set-ting value	Block A Para-meter	Block B, C Parameter																																												
		Basic	Extend	S/W	H/W																																									
1	○	○	○	○	○																																									
2	×	×	×	×	×																																									
3	○	×	×	×	×																																									
4	○	×	○	×	×																																									
5	○	×	○	○	×																																									
2	Station No.		1.	0.	247.	Set the local station No.																																								
3	Response timer	sec.	0.00	0.00	2.00	Set the minimum time from receiving command to returning an answer.																																								
4	CN2 standard serial communication baud rate setting	bps	2.	1.	5.	=1: 4800 =2: 9600 =3: 14400 =4: 19200 =5: 38400																																								
5	CN2 standard serial communication stop bit setting		2.	1.	2.	=1: 1 bit =2: 2 bit																																								
6	CN2 standard serial communication parity setting		3.	1.	3.	=1: None =2: Even =3: Odd																																								
7	Base section serial communication frequency (speed) unit setting		0.	0.	5.	=0: 0.01Hz or 0.1min ⁻¹ unit: signed =1: 0.1Hz or 1min ⁻¹ unit: signed =2: 0.01% unit: signed =3: 0.01Hz or 0.1min ⁻¹ unit: unsigned =4: 0.1Hz or 1min ⁻¹ unit: unsigned =5: 0.01% unit: unsigned																																								

The settings after the power is turned ON are as follows.

Communication protocol : Standard serial communication

Baud rate : 38400bps

Frame configuration : Start: 1bit, Data: 8bit, Stop: 1bit, Parity: None, Station No.: 18

6-12-4 Using the VT240S Series dedicated communication (standard serial communication)

The following exchanges can be carried out with the host computer by using the VT240S series dedicated communication protocol (hereinafter, standard serial communication).

- (1) Reading and writing of Block-A, B, C, U parameters
- (2) Reading of Block-D monitor parameters
- (3) Reading and writing of sequence commands
- (4) Reading and writing of frequency commands and speed commands
- (5) Reading and writing of torque commands, torque bias 1 settings, drive torque limiter reduction settings, regenerative torque limiter reduction settings
- (6) Reading of fault history

6-12-4-a. Setting the standard serial transmission function

- (1) When executing setting data write (FW) from the host computer and operating, make sure that the sequence command CFS is ON, and that the various setting input point selection C02 is fixed to serial.

Example) 1) Operation mode : Remote (RMT)
Speed setting input point selection: C02-0=4 (sequence)
CFS command : C04-1=4 (controlled with terminal block input PSI4), or

- 2) Speed setting input point selection: C02-0=2 (serial fixed)
The details of the setting data are determined by the control mode selection (C30-0: f0) and FW command data No. Refer to section 6-12-4-g Setting data write (FW) for details.

- (2) When executing sequence command write (CW) from the host computer and operating, make sure that the sequence command COP is ON.

Example) Operation mode : Remote (RMT)
COP command : C03-8 = 16
(The inverter is always run with the sequence commands from the host computer.)

Refer to section 6-12-4-i Sequence command write (CW) for details on the CW command.
Refer to section 5-5 Sequence input logic Fig. 5-5 for details on the sequence input logic.

Note) When sending the auxiliary operation sequence command in Fig. 5-5, make sure that control switchover method (J2 setting) C00-6 is set to serial transmission input.

Control switchover method (J2 setting): C00-6 = 2 (serial transmission input)

- (3) Set parameter change protection with C26-1.
- (4) Set the local station number with C26-2.
- (5) Set the response timer value with C26-3.
The response timer is the timer which specifies the minimum time for the VT240S to return the response packet after the host computer sends the command packet.



When setting the frequency/speed and controlling the sequence with serial transmission, the automatic start and restart after power failure functions may not operate correctly. This is caused by a difference in the power voltage operation and time for transmitting the command.

6. Control Functions and Parameter Settings

- (3) The check sum is always added to the response packet.
The check sum can be omitted from the packet sent from the host computer, but the check sum is always added to the packet sent from the VT240S.
- (4) All transmission and reception data is 8-bit ASCII data.
- (5) All data input before "(" is input in the reception data is ignored.
- (6) Even if "(" is input while receiving the packet, the data received up to that point will be aborted.

(Example)

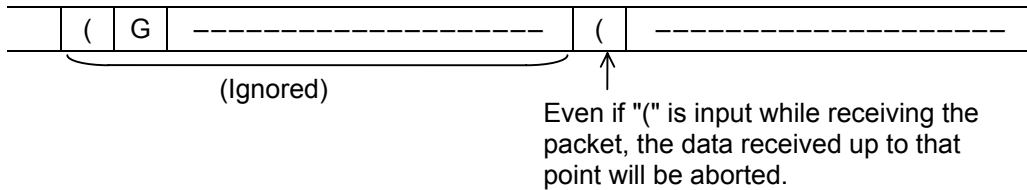

- (7) The reception is interpreted as done only when ")" CR is received.
- (8) Several commands can be arranged in one packet. (Up to nine commands.)
In this case, "," is used as the delimiter between commands.
If there are more than ten commands in one packet, error codes (illegal commands) equivalent to the number of excessive commands will be returned from the VT240S.
Up to nine commands will be executed normally. An example of the command and response is shown below.

(Example) Host computer transmission command packet

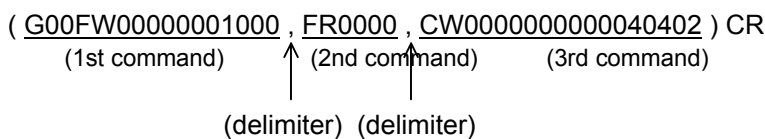

Response packet

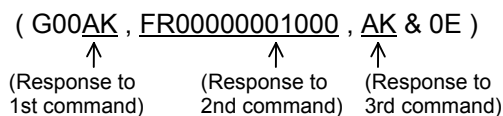

Make sure that the command packet fits within 128 Bytes.
Also make sure that the response packet in respect to the command packet is within 128 Bytes.

- (9) A broadcast packet can be sent.
By setting the station No. to "FF", all VT240S units in the transmission path will process the packet.
The VT240S will not send any response packet in respect to the broadcast packet. Thus, only write request commands are valid in the broadcast packet.

(Example)

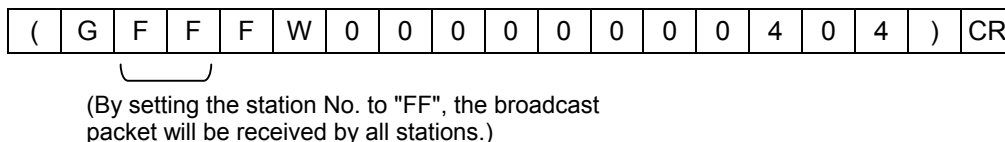

6-12-4-e. Creating a check sum

(Example)

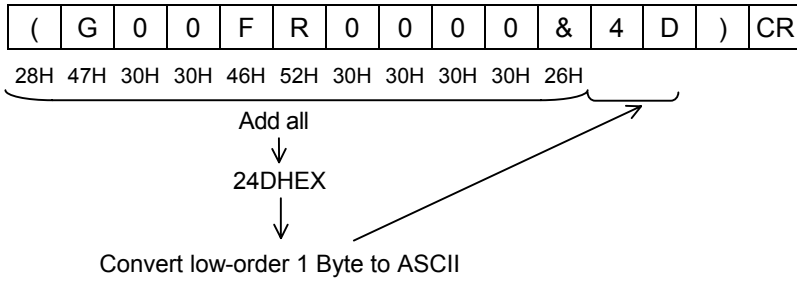

The ASCII codes of the characters between "(" and "&" are added with hexadecimal, and the low-order byte of the obtained value is converted into an ASCII code and used for the check sum.

6. Control Functions and Parameter Settings

6-12-4-f. Transmission commands

Basic command format

CMD (2 Byte)	Data No. (4 Byte)	DATA
-----------------	----------------------	------

Command list

Host computer to VT240S			
CMD	Data No.	DATA	Function
FW	000n	Nnnnnnn (7-digit decimal)	Setting data write
FR	000n	None	Setting data read
CW	000n	nn nn (12-digit hexadecimal)	Sequence command write
CR	000n	None	Only sequence command read
DW	Annn Bnnn Cnnn Unnn	Nnnnnn (6-digit decimal)	Block-A, B, C, U parameter write
DR	Dnnn Annn Bnnn Cnnn Unnn	None	Block-D, A, B, C, U parameter read
ER	000n	None	Fault history read

Host computer from VT240S			
CMD	Data No.	DATA	Function
FR	000n	Nnnnnnn (7-digit decimal)	Setting data read (response)
CR	000n	nn nn (12-digit hexadecimal)	Sequence command read (response)
DR	Dnnn Annn Bnnn Cnnn Unnn	Nnnnnn (6-digit decimal)	Block-D, A, B, C, U parameter read (response)
ER	000n	nn nn (44-digit)	Fault history read (response)
AK	None	None	Successful completion response in respect to write request command
NK	Error code nn (2 byte)	None	Error response in respect to command

6. Control Functions and Parameter Settings

6-12-4-g. Setting data write (FW)

Function : The setting data is written to the selected setting register when the sequence command CFS is ON and the various setting input point selection: C02 is set to serial fixed. The contents of the setting data are determined by the control mode selection (C30-0: f0) and data No. Refer to Appendix Table 5 for the data No.

Command

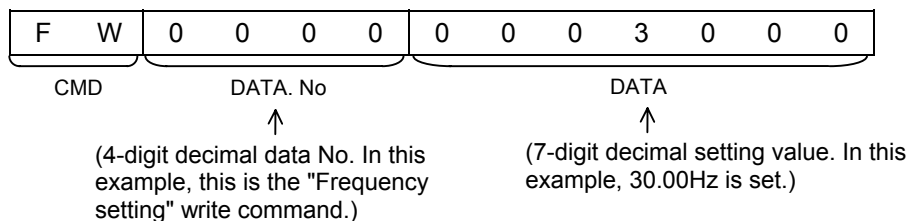

Response

A	K	(Successful completion)
---	---	-------------------------

N	K	Error code (2 Byte)	←	(Error response: Refer to Section 6. List of transmission error codes for details on the error codes.)
---	---	---------------------	---	--

Setting data table

Control mode	DATA No.	Name	Unit	Min. value	Max. value
V/f control C30-0 : f0 = 1	0 0 0 0	Frequency command	Following C26-7 setting	0.10	440.00
	0 0 0 0	Speed command		-7200.0	7200.0
Vector, PM control C30-0 : f0 = 2, 3, 4	0 0 0 0	Torque setting	0.1%	-300.0	300.0
	0 0 0 0	Torque bias 1 setting	0.1%	-300.0	300.0
	0 0 0 0	Drive torque limiter reduction setting	0.1%	0.0	100.0
	0 0 0 0	Regenerative torque limiter reduction setting	0.1%	0.0	100.0

Coded data

(Example)

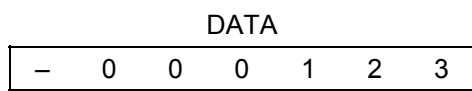

(The data will be negative data when "-" is added.)

The data can be set as negative data by adding "-" to the highest order digit of the DATA area. In the above example, the data is -123.

Frequency command/speed command unit

The unit for the frequency command/speed command can be changed with the C26-7: frequency (speed) unit setting. Refer to the 6-4: Parameter list or explanations.

The default setting is C26-7=0: 0.01Hz or 0.1min⁻¹ (signed)

6-12-4-i. Sequence command write (CW)

Function : A sequence command is issued to the VT240S. The data sent at this time is held by the internal sequence command register until it is rewritten. To validate this sequence command, the sequence command: COP must be ON.
 Refer to section 6-12-5-a Setting the standard serial transmission function for details on setting COP.

Command

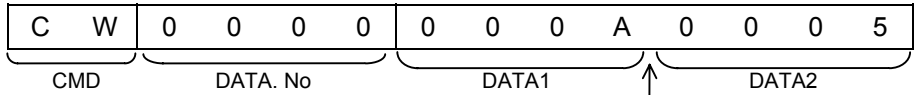

(4-digit decimal. Refer to section 6-12-5-o Sequence command bit assignment table for the numbers.)

(8-digit hexadecimal setting value. In this example 000A0005h is set.
 * Refer to section 6-12-5-o Sequence command bit assignment table for details on the setting values.

Response

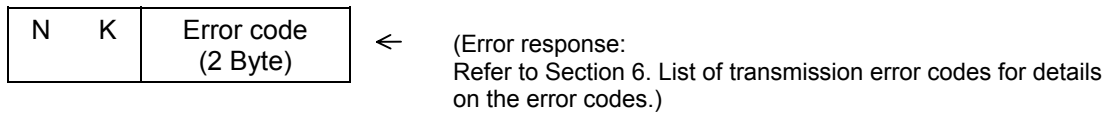
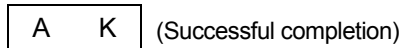

6-12-4-j. Sequence command read (CR)

Function : The sequence command set with the CW command is read and returned.

Command

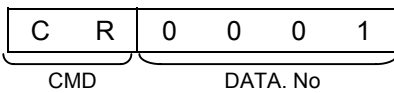

(4-digit decimal date No.
 Refer to section 6-12-5-o Sequence command bit assignment table for the numbers.)

Response

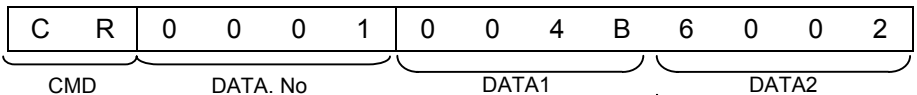

(4-digit decimal.
 The data No. from the host computer is returned.)

(8-digit hexadecimal read data. In this example, 004B6002h is read.)
 * Refer to section 6-12-5-o Sequence command bit assignment table for details on the setting values.

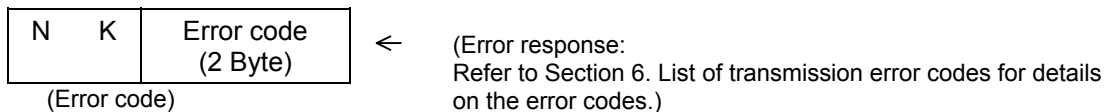

6. Control Functions and Parameter Settings

6-12-4-k. Block- A, B, C and U parameter write (DW)

Function : The Block-A, B, C and U parameter data in the VT240S unit is changed.

Note that the parameter change protection may be set with C26-1.

Parameters which cannot be changed during operation, cannot be changed during operation. Other parameters which cannot be changed during serial transmission are listed in the cautions.

The data is configured from the list of constants without the decimal point.

Example) A010 (Acceleration ramp time -1) 50.0 s → 000500

Command

<Example: Block-A parameter setting>

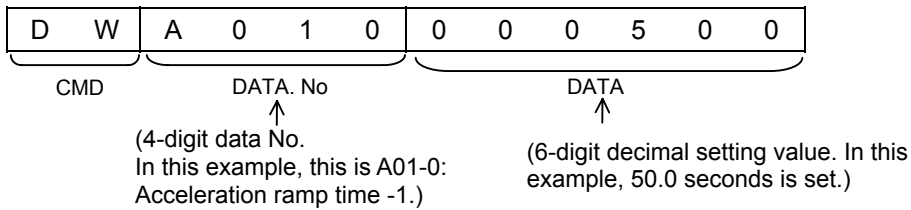

Response

A	K	(Successful completion)
---	---	-------------------------

N	K	Error code (2 Byte)	← (Error response Refer to Section 6. List of transmission error codes for details on the error codes.)
---	---	------------------------	---

Setting data table

DATA No.	Name
A n n n	Block-A parameter
B n n n	Block-B parameter
C n n n	Block-C parameter
U n n n	Block-U parameter

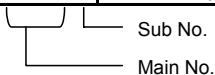



CAUTION

The parameters that cannot be changed with the write command are shown below. If the write command is executed for these parameters, an error will be returned (Parameter Read/Write Disable).

- A04-0 to 7 (Custom constants)
- A05-0 to 2 (Block-B, C parameter display skip)
- B19-0 (Automatic tuning function)
- Parameters not related to control mode selected with C30-0: f0.
(Parameters that are not displayed on the operation panel.)
- C10-0 to 7 (Custom parameter selection)
- C26-0 to 2 (Serial transmission setting)

Coded data

The data can be set as negative data by adding "-" to the highest order digit of the DATA area.

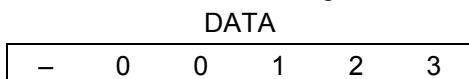

6-12-4-I. Block-A, B, C, U and D parameter read (DR)

Function : The values of the block-A, B, C, U and D parameters in the VT240S are read.

Command

<For monitor data read>

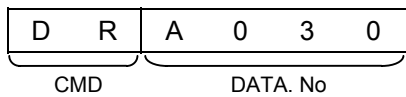

↑
(4-digit decimal data No. Refer to the previous setting data table for details on the

Response

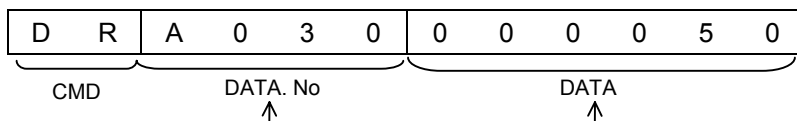

↑
4-digit data No.
The data No. from the host
computer is returned.)

↑
(6-digit decimal setting value.
In this example, 50 is set.)

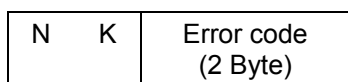

← (Error response:
Refer to Section 6. List of transmission error codes for details
on the error codes.)

Setting data table

DATA No.	Name
D n n n	Block-D parameter
A n n n	Block-A parameter
B n n n	Block-B parameter
C n n n	Block-C parameter
U n n n	Block-U parameter

└───┬───┘ Sub No.
└──────────┘ Main No.

CAUTION

The parameters that cannot be read with the read command are shown below. If the read command is executed for these parameters, an error will be returned (Parameter Read/Write Disable). Refer to 6-12-4-n. List of transmission error codes for details on the error codes.

- D20-0 (Fault history display)
- D20-1 (Minor fault history display)
- D20-2 (Parameter A, B, C change list)
- D30-0 (Inverter type)
- D30-1 (Option PCB)
- D22-0 (Automatic tuning progress state)
- A04-0 to 7 (Custom constants)
- A05-0 to 2 (Block-B, C parameter skip)
- C10-0 to 7 (Custom parameter selection)
- Parameters not related to control mode selected with C30-0: f0.
(Parameters that are not displayed on the operation panel.)

If the data is coded data targeted for read, "-" will be attached to the highest-order digit of DATA.

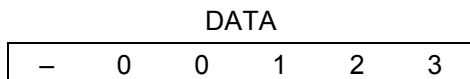

6-12-4-m. Fault history read (ER)

Function : The fault history buffer of the VT240S is read.

Command

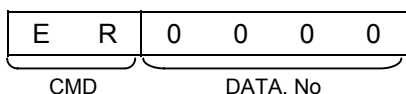

↑
(4-digit decimal data No. refer to the table on the right for details on the number.)

DATA No.				Explanation
0	0	0	0	Latest fault history
0	0	0	0	Previous fault history
0	0	0	0	2nd to last fault history
0	0	0	0	3rd to last fault history

Response

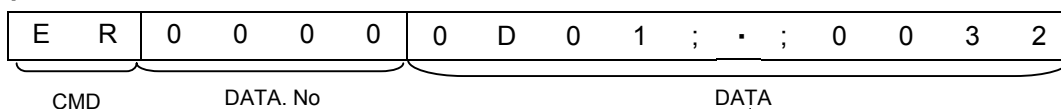

↑
4-digit data No.
The data No. from the host computer is returned.)

↑
(Fault buffer corresponding to setting is displayed.)

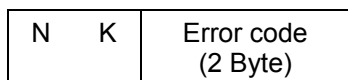

← (Error response:
Refer to Section 6. List of transmission error codes for details on the error codes.)

There are four fault history buffers from the latest to the 3rd to last fault histories. One group of these buffers is stored in the response.

In one buffer, two fault causes, and the output frequency, output current, DC voltage, hardware fault signal, cumulative power ON time, and cumulative run time at the time of fault occurrence are stored. Refer to Appendix Table 4 for the fault cause display and details.

Details of group (DATA)

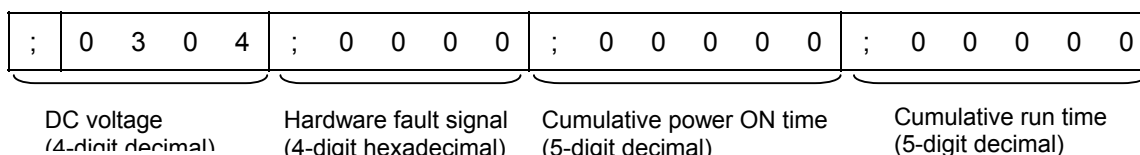
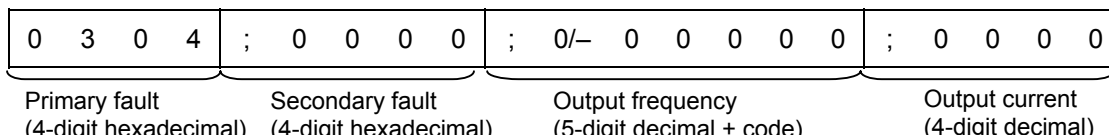

The above information is contained in the response data. A 43-byte data is sent.

"," is used to delimit each item in the group.

Refer to Appendix 3 List of fault codes for details on the primary fault and secondary fault.

The hardware fault signal displays the status of the D05-1: ASIC error display bit as a 0 to FF hexadecimal.

6. Control Functions and Parameter Settings

6-12-4-n. List of transmission error codes

The error codes added to the NK response in respect to a command from the host computer are shown below.

Error code	Error name	Details
01	Transmission error	A transmission error, such as parity error or overrun error, was detected.
02	Check sum error	The check sum is illegal.
10	Illegal command	The command is not defined.
11	Illegal parameter	1) The parameter does not exist, or 2) The transmission format does not match.
12	Illegal data	1) The data limit is exceeded, or 2) The format does not match.
13	Parameter protect	The designated parameter is write-protected. (Write-protected with C26-1.)
14	Changing not possible during operation	The designated parameter cannot be changed during operation.
15	Transmission/reception buffer overflow	The transmission/reception data exceeds 128 Bytes.
16	Parameter read/write disable	A read or write-prohibited parameter was accessed.
20	EEPROM BUSY	The VT240S is using the non-volatile memory.

6. Control Functions and Parameter Settings

6-12-4-o. Serial transmission sequence command Bit assignment table

DATA No : 0 0 0 0

DATA1

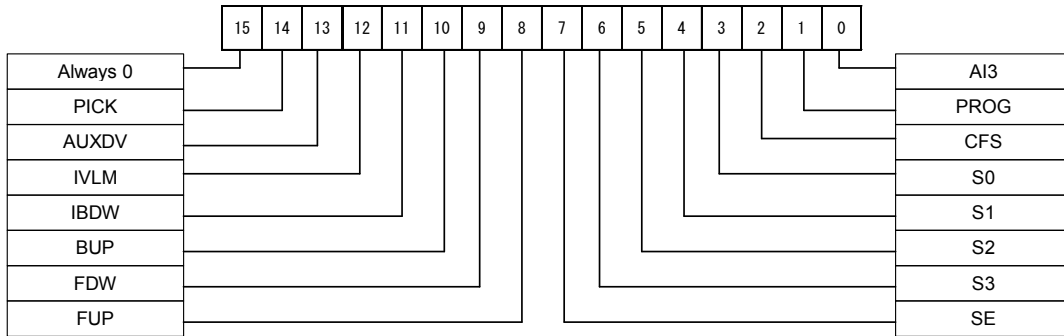

DATA2

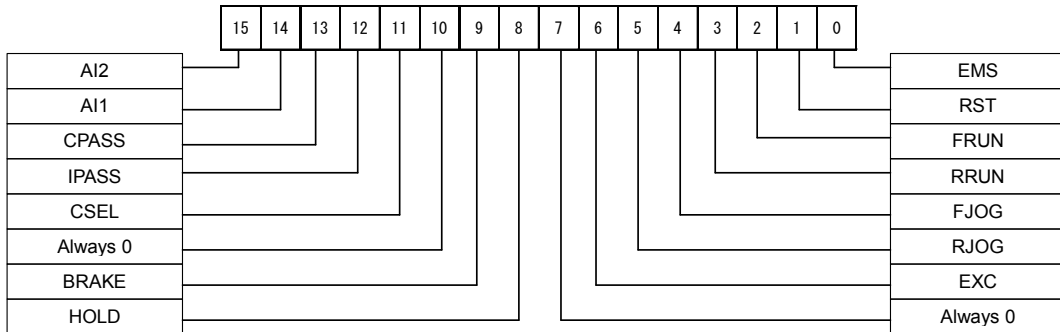

DATA No : 0 0 0 1

DATA1

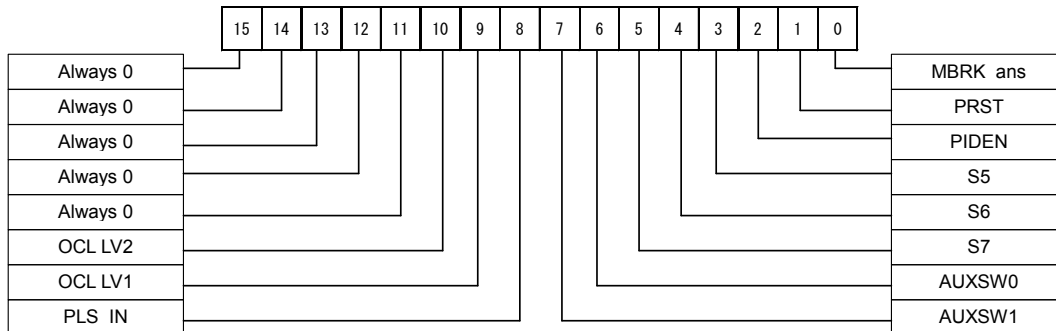

DATA2

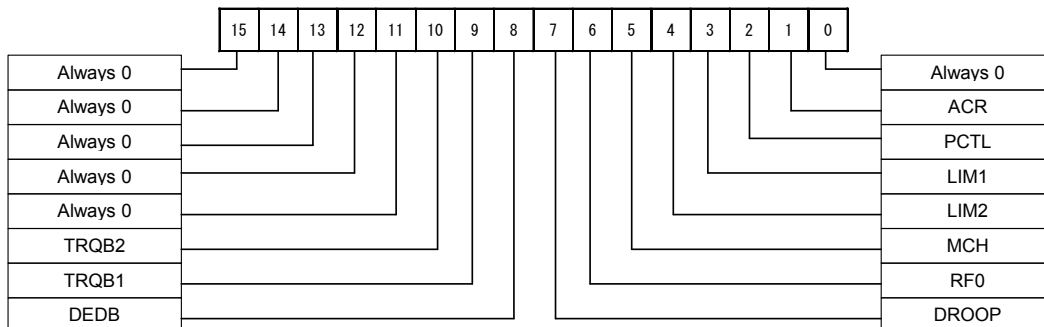

6-12-5 Using Modbus communication

The Modbus communication method is a single master/slave method. Only the master can start communication. The slave detects this communication, executes the designated function, and returns a response message. The master can communicate with the designated slave (station No.) and broadcast to all slaves. When using broadcast transmission, the slave only carries out the designated function and does not return a response message.

The following exchanges can be made with the host computer by using this communication function.

- (1) Reading and writing of Block-A, B, C, U parameters
- (2) Reading of Block-D monitor parameters
- (3) Reading and writing of sequence commands
- (4) Reading and writing of frequency commands and speed commands
- (5) Reading and writing of torque commands, torque bias 1 settings, drive torque limiter reduction settings, regenerative torque limiter reduction settings
- (6) Reading of fault history
- (7) Reading of sequence status

6-12-5-a. Setting the Modbus communication function

- (1) When executing setting data write from the host computer and operating, make sure that the sequence command CFS is ON, and that the various setting input point selection C02 is fixed to serial.

Example) 1) Operation mode : Remote (RMT)
Speed setting input point selection: C02-0=4 (sequence)
CFS command : C04-1=4 (controlled with terminal block input PSI4), or
2) Speed setting input point selection: C02-0=2 (serial fixed)

The details of the setting data are determined by the control mode selection (C30-0: f0). Refer to 6-12-5-f List of Modbus registers and setting examples for details. Refer to Fig. 5-9-1 to Fig. 5-9-8 for the sequence for selecting the determined setting data.

- (2) When executing sequence command write from the host computer and operating, make sure that the sequence command COP is ON.

Example) Operation mode : Remote (RMT)
COP command : C03-8 = 16
(The inverter is always run with the sequence commands from the host computer.)

Refer to section 5-5 Sequence input logic Fig. 5-5 for details on the sequence input logic.

Note) When sending the auxiliary operation sequence command in Fig. 5-5, make sure that control switchover method (J2 setting) C00-6 is set to serial transmission input.
Control switchover method (J2 setting): C00-6 = 2 (serial transmission input)

- (3) Set parameter change protection with C26-1.
- (4) Set the local station number with C26-2.

CAUTION

When setting the frequency/speed and controlling the sequence with serial transmission, the automatic start and restart after power failure functions may not operate correctly. This is caused by a difference in the power voltage operation and time for transmitting the command.

6. Control Functions and Parameter Settings

6-12-5-b. Modbus protocol

The VT240S is compatible only with the Modbus compliant RTU mode.
The communication protocol for the RTU mode is explained below.

End/start	Address	Function	Data	CRC	End/start
Silent interval of 3.5 characters or more	8bit	8bit	8bit × n	16bit	Silent interval of 3.5 characters or more
Changeable with C26-3	Slave: 1 to 99 Broadcast: 0	Correspondence: 0x01, 0x02, 0x03, 0x08, 0x0F, 0x10, 0x17 Exception response: BIT7: ON		Calculated for each command	Changeable with C26-3

In the RTU mode, a silent interval of 3.5 characters or more (varies according to baud rate) is inserted at the start and end of transmission. The silent interval is a state in which data is not sent. Note that if C26-3 is not equal to 0.00, the setting value will be followed.

The slave side station No. is designated as Address. If a request is made from the slave side, the local station No. is set. The station No. is set with C26-2.

The function executed by the slave is designated in Function and Data. Refer to the following explanations for details on the functions.

CRC is an error check. Each is automatically calculated and set based on the details of Address to Data. The following calculation method is used.

- 1) CRC work = 0 × FFFF
- 2) CRC work low-order byte = CRC work low-order byte XOR send data (8-bit)
- 3) The following process is executed according to the state of the CRC work LSB.

CRC work LSB	Process
0	CRC work is shifted one bit to the right. MSB is set to 0 at this time.
1	CRC work is shifted one bit to the right. MSB is set to 0 at this time. The following operation is executed. CRC work = CRC work XOR 0xA001

- 4) The step 3) process is repeated for 8 bits (8 times).
- 5) The steps 2) to 4) are repeated for all send data (data from Address to before CRC).
- 6) The CRC work calculated with steps 1) to 5) is CRC.

Example of command:

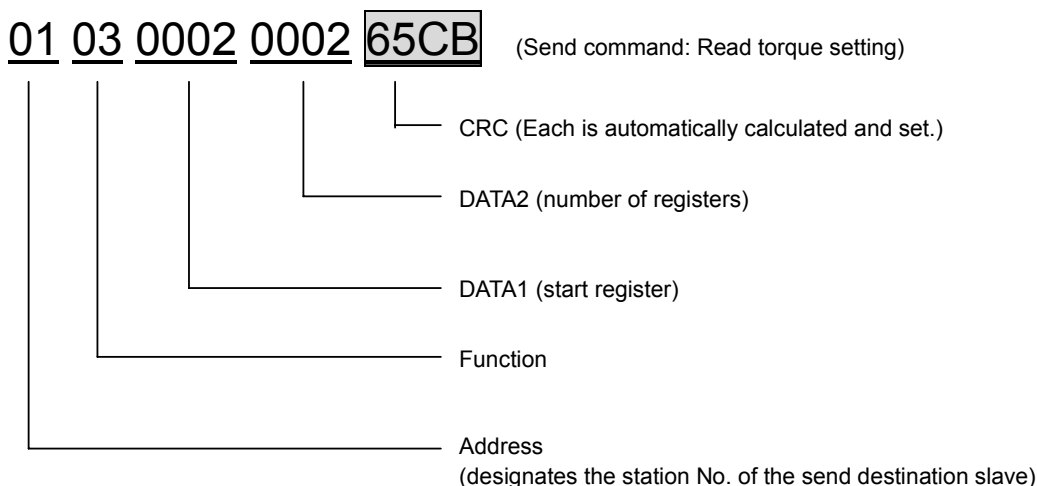

CAUTION

In the command example, a space is inserted to delimit each function. Do not insert the spaces when actually inputting the command.
In the above command, input [01030002000265CB], and send.

6-12-5-c. VT240S Modbus communication time chart

The time chart for communication with the host computer is shown below.

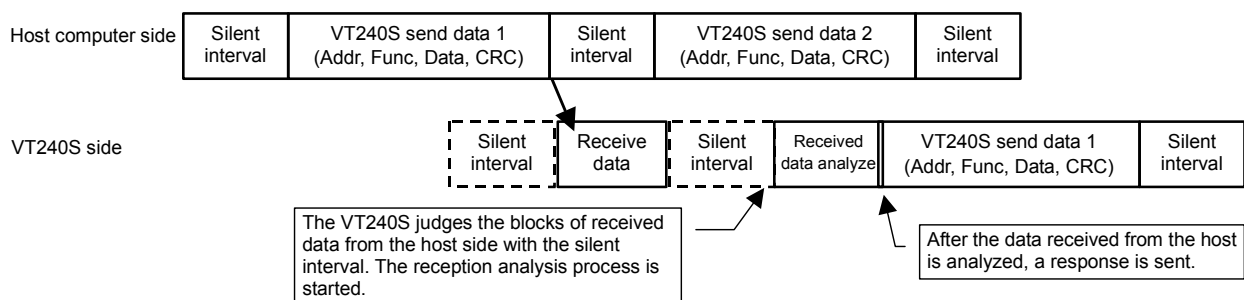

he host computer waits for the silent interval time, and then sends one packet of data.

When sending data continuously, the host computer waits for the silent interval again.

The VT240S recognizes the data sent after waiting the silent interval as the head of the packet, and starts the reception process. After the data is received, if a state in which no data is received for longer than the silent interval continues, the VT240S determines that the reception is completed, judges and processes the contents of the command, and creates a request package.

6-12-5-d. Exceptional response code

The VT240S judges and processes the data based on the packet received from the host computer. If the data is illegal or if data exceeding the range is received, an exception response is returned to indicate that the process cannot be completed.

The exceptional response is sent by setting bit7 of the sent function code to 1.

The exception response code sent after the function code are shown below.

List of exception response codes

Code	Name	Occurrence conditions
01h	Illegal function	A function code, which is not listed, was set.
02h	Illegal data address	An address which does not exist was set.
03h	Illegal data	An error was found in the data setting.
04h	IO data incorrect setting	In the MUX data instruction, the set and input data exceeds the maximum value or minimum value.
05h	MUX data corresponding No. not found	In the MUX data instruction, the set and input parameter block No. or data No. does not exist.
06h	MUX data incorrect setting	In the MUX data instruction, the write data set with the multiplex data is an illegal data.
07h	MUX data lock	In the MUX data instruction, write or read was not possible. (Refer to CC-Link Function Specifications.)
0Bh	Parameter function code incorrect	A parameter function code which does not exist was set.
0Ch	Outside input data range	The written data exceeds the inverter setting range.
10h	No corresponding parameter	The read/write destination parameter was not found, or is set to "hide".

6. Control Functions and Parameter Settings

An example of the exception response sent from VT240S is shown below.

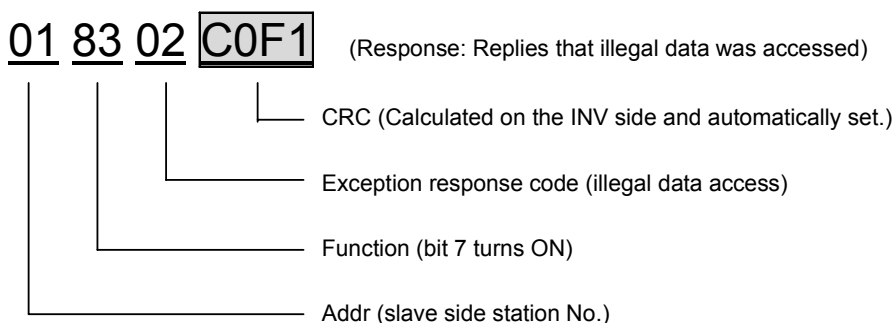

CAUTION

In the command example, a space is inserted to delimit each function. Do not insert the spaces when actually inputting the command.
 In the above example, the response is displayed as [018302C0F1].

6-12-5-e. List of standard serial communication code correspondence

The correspondence of the previous standard serial communication command and the MODBUS functions is shown below.

Function	Start register: Function	Standard serial communication command
01h Read Coil Status	0000 : Sequence command (input) 1 read 0020 : Sequence command (input) 2 read	CR
02h Read Input Status	Sequence status (output) read	–
03h Read Holding Register	0000 : V/f Frequency setting read 0000 : VEC/PM Speed setting 0002 : VEC/PM Torque setting 0004 : VEC/PM Torque bias 1 setting 0006 : VEC/PM Drive torque limiter reduction setting 0008 : VEC/PM Regenerative torque limiter reduction setting	FR
03h Read Holding Register	Fault information read 0063 : Read latest fault information 0073 : Read previous fault information 0083 : Read 2nd to last fault information 0093 : Read 3rd to last fault information 00A3 : Read latest minor fault information 00B3 : Read previous minor fault information 00C3 : Read 2nd to last minor fault information 00D3 : Read 3rd to last minor fault information	ER
08h Diagnostic	Self-diagnosis mode	–
0Fh Force Multiple Coils	0000 : Sequence command (input) 1 write 0020 : Sequence command (input) 2 write	CW
10h Preset Multiple Registers	0000 : V/f Frequency setting 0000 : VEC/PM Speed setting 0002 : VEC/PM Torque setting 0004 : VEC/PM Torque bias 1 setting 0006 : VEC/PM Drive torque limiter reduction setting 0008 : VEC/PM Regenerative torque limiter reduction setting	FW
10h Preset Multiple Registers	Parameter write	DW
17h Read/Write Multiple Registers	Parameter read	DR

6. Control Functions and Parameter Settings

6-12-5-f. List of Modbus registers and setting examples

The details of each function and examples of setting the commands are given in the following section.

◆ Function 01h (Read Coil Status)

Details of function	Start register designation	Number of registers
Sequence command (Input) read	0000h : Sequence command 1 0020h : Sequence command 2	0020h (Sequence data 32 bit)

Function : The sequence command (input) is read.

This function carries out the same process as the CR command in the standard serial transmission function.

Refer to section 6-12-4-o. Serial transmission sequence command bit assignment table for the layout of bits in the read command.

Setting example:

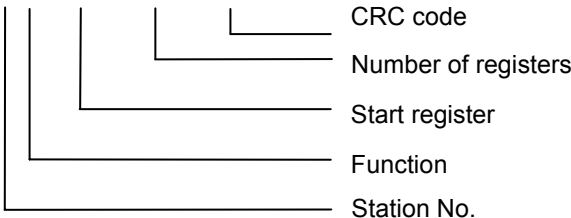
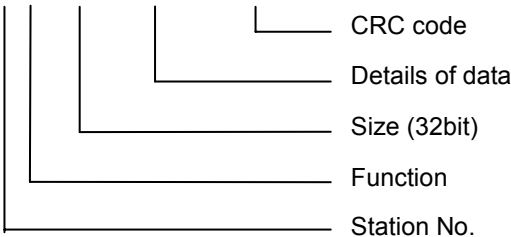
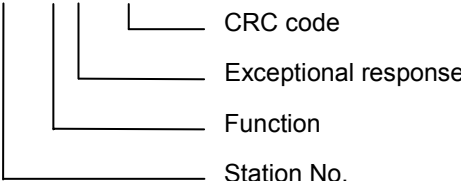
Modbus command setting example	
<p><u>01 01 0000 0020 3DD2</u></p>  <p>CRC code Number of registers Start register Function Station No.</p> <p>Command contents : The contents of the sequence command 1 are read.</p>	
Response	
<p><u>01 01 02 10035007 FAD3</u> (Successful example)</p>  <p>CRC code Details of data Size (32bit) Function Station No.</p>	<p><u>01 81 02 C191</u> (Example of failure)</p>  <p>CRC code Exceptional response Function Station No.</p>

The correspondence of the read data contents and serial transmission sequence command's bit assignment table is shown below.

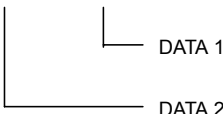
Standard serial (DATA No.)	MODBUS (Start register)	Details of data
0 0 0 0	→ 0 0 0 0	<p><u>1003 5007</u></p>  <p>DATA 1 DATA 2</p>
0 0 0 1	→ 0 0 0 2	

6. Control Functions and Parameter Settings

◆ Function 02h (Read input Status)

Details of function	Start register designation	Number of registers
Sequence status read	000h : Fixed	0040h (Sequence data 64 bit)

Function : The sequence status is read.

Refer to the bit assignment table on the next page for the layout of bits in the read command.

Setting example:

Modbus command setting example

01 02 0000 0040 79FA

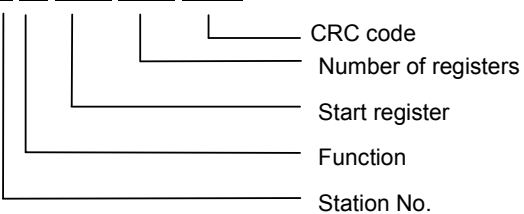

Command contents : The contents of the sequence status are read.

Response

01 02 08 10035007 3827811F D37D (Successful example)

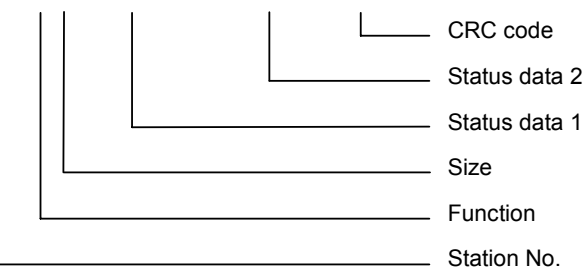

01 82 03 00A1 (Example of failure)

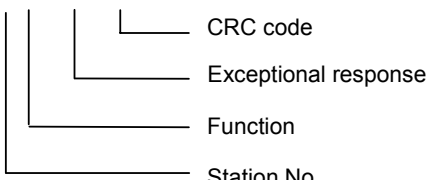

The contents of the read status data are as follow.

1003 5007 3827 811F

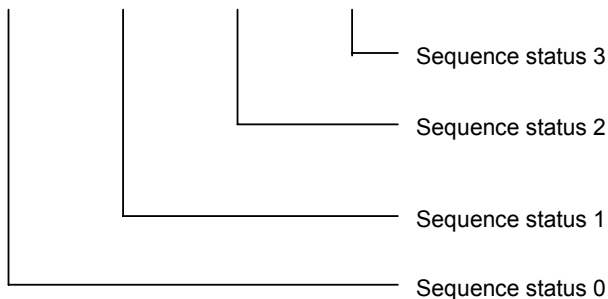

Refer to the following table for the bit assignment of each status.

Serial transmission sequence status bit assignment table

Sequence status 0

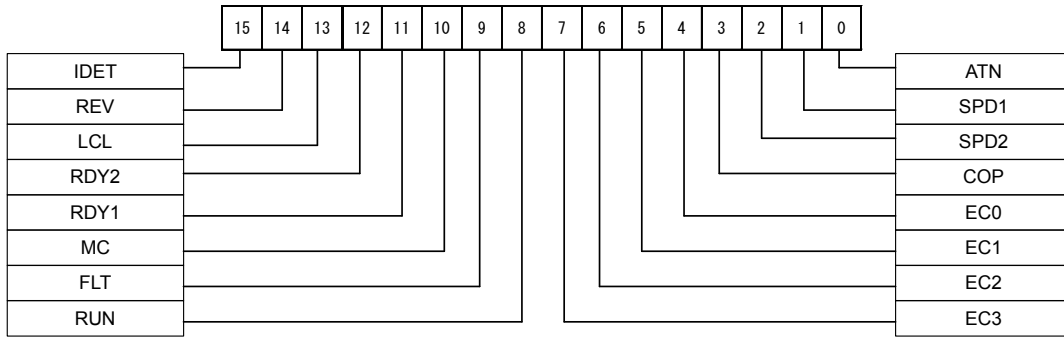

Sequence status 1

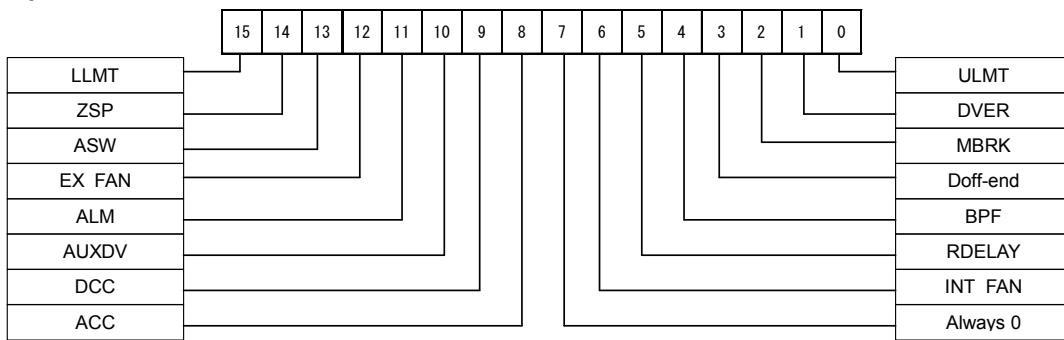

Sequence status 2

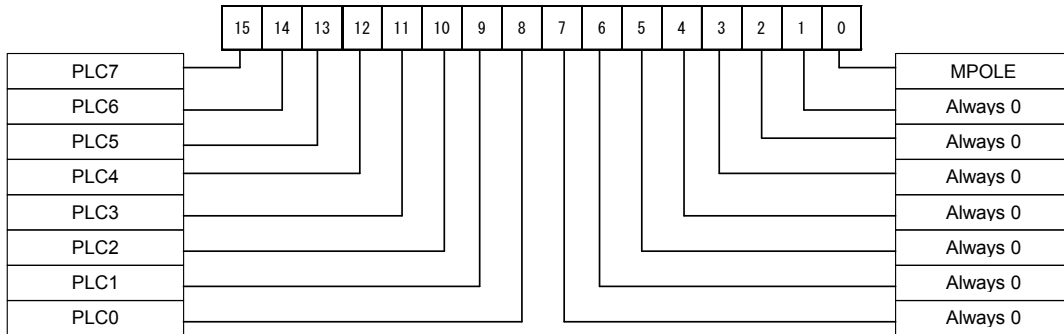

Sequence status 3

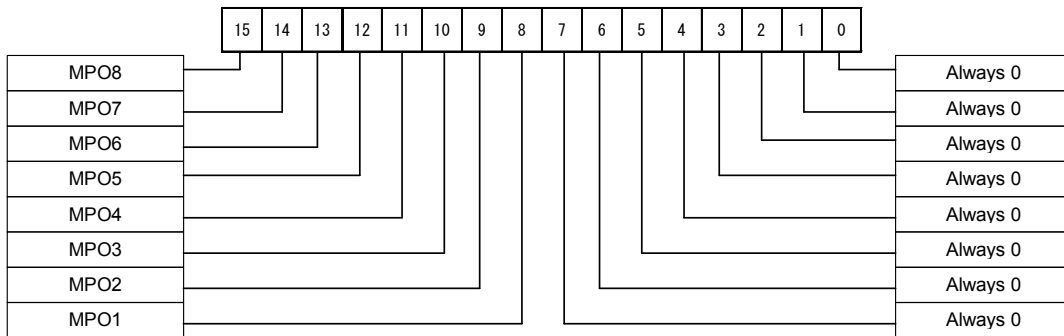

6. Control Functions and Parameter Settings



◆ Function 03h (Read Holding Register)

Control mode	Details of function	Start register	Number of registers	Unit	Min. value	Max. value
V/f control	Frequency setting	0000h	0002h (32-bit data)	Following C26-7 setting	-440.00	440.00
IM vector control PM motor control	Speed setting	0000h	0002h (32-bit data)		-7200.0	7200.0
	Torque setting	0002h	0002h (32-bit data)	0.1%/LSB	-300.0	300.0
	Torque bias 1 setting	0004h	0002h (32-bit data)	0.1%/LSB	-300.0	300.0
	Drive torque limiter reduction setting	0006h	0002h (32-bit data)	0.1%/LSB	0.0	100.0
	Regenerative torque limiter reduction setting	0008h	0002h (32-bit data)	0.1%/LSB	0.0	100.0

Function : Each setting value is read.

This function carries out the same process as the FR command in the standard serial transmission function.

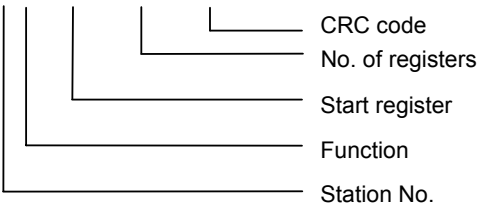
Setting example:

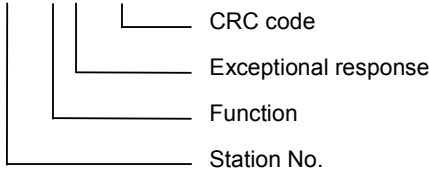
Modbus command setting example	
<p><u>01 03 0002 0002 65CB</u></p>  <p style="margin-left: 20px;"> CRC code No. of registers Start register Function Station No. </p> <p>Command contents : Torque setting value is read.</p>	
Response	
<p><u>01 03 04 000003E8 FA8D</u> (Successful example)</p>  <p style="margin-left: 20px;"> CRC code Data Size (32bit) Function Station No. </p>	<p><u>01 83 02 C0F1</u> (Example of failure)</p>  <p style="margin-left: 20px;"> CRC code Exceptional response Function Station No. </p>

Frequency command/speed command unit

The unit for the frequency command/speed command can be changed with the C26-7: frequency (speed) unit setting. Refer to the 6-1: Parameter list or explanations.

The default setting is C26-7=0: 0.01Hz or 0.1min⁻¹ (signed)

6. Control Functions and Parameter Settings

Details of function	Start register	Number of registers	
Fault history buffer	Latest fault history	0063h	0010h
	Previous fault history	0073h	0010h
	2nd to last fault history	0083h	0010h
	3rd to last fault history	0093h	0010h
	Latest minor fault history	00A3h	0010h
	Previous minor fault history	00B3h	0010h
	2nd to last minor fault history	00C3h	0010h
	3rd to last minor fault history	00D3h	0010h

Function : One block of the fault history is read.

This function carries out the same process as the ER command in the standard serial transmission function. Refer to the following section for the contents read out.

Setting example:

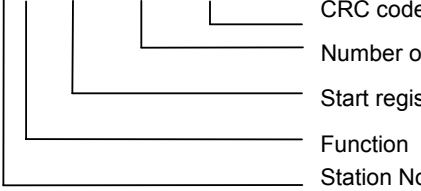
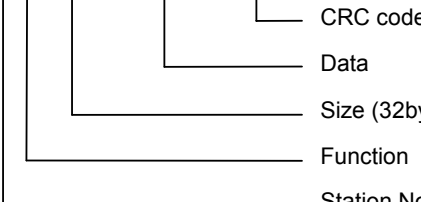
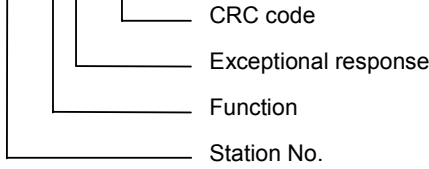
Modbus command setting example	
<p><u>01 03 0063 0010 B418</u></p>  <p>Command contents : Torque setting value is read.</p>	
Response	
<p><u>01 03 20 0000~0000 xxxx</u> (Successful example)</p> 	<p><u>01 83 02 C0F1</u> (Example of failure)</p> 
<p>Refer to the following section for the data contents.</p>	

The data is configured of 32 bytes.

Each item is grouped in a 4-byte section. The details of the 4 bytes are shown below.
(The values in the following table are a setting example.)

0000203	000040D	00003E8	0000005F	000013A	0000001	0000000	0000000
Primary fault details	Secondary fault details	Frequency value at fault	Current value at fault	DC voltage at fault	Hardware fault signal	Cumulative power ON time	Cumulative run time
		0.01Hz/LSB	0.1A/LSB	1V/LSB		2 hours/LSB	2 hours/LSB

Refer to Appendix 3 Fault Codes for details on the primary fault and secondary fault.

The hardware fault signal displays the status of the D05-1: ASIC error display bit as a 0 to FF hexadecimal.

6. Control Functions and Parameter Settings

◆ Function 0Fh (Force Multiple Coils)

Details of function	Start register command	Number of registers	No. of bytes
Sequence command (input) write	0000h : Sequence command 1 0020h : Sequence command 2	0020h (Sequence data 32 bit)	0004h

Function : The sequence command is written.

This function carries out the same process as the CW command in the standard serial transmission function.

A 4byte command can be written in one command.

Refer to section 6-12-4-o. Serial transmission sequence command bit assignment table for details on the bit assignment of the sequence command to be written in.

Setting example:

Modbus command setting example

01 0F 0000 0020 04 01234567 47C4

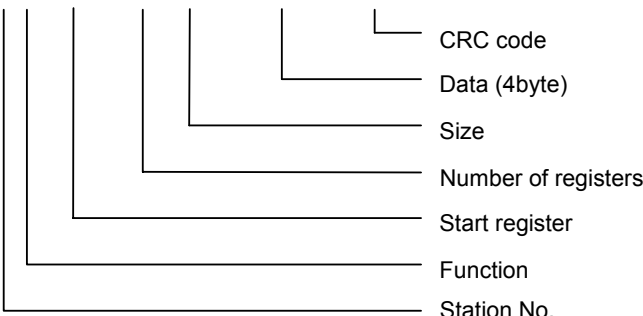

Command contents : The data contents are written to sequence command 1.

Response

01 0F 20 3003 (Successful example)

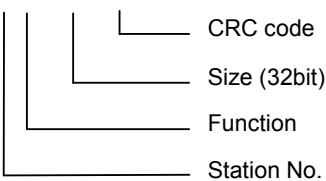

01 8F 02 C5F1 (Example of failure)

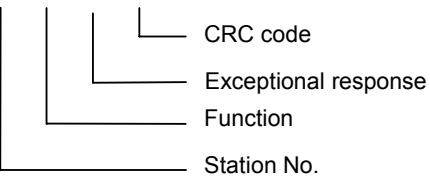

The correspondence of the written sequence command bit assignment is shown below.

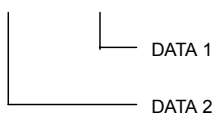
Standard serial (DATA No.)	MODBUS (Start register)	Details of data
0 0 0 0	→ 0 0 0 0	<u>0123 4567</u> 
0 0 0 1	→ 0 0 2 0	

6. Control Functions and Parameter Settings

◆ Function 10h (Preset Multiple Registers)

Control mode	Details of function	Start register	Number of registers	Number of bytes	Unit	Max. value	Min. value
V/f control	Frequency setting	0000h	0002h (32-bit data)	04h	Following C26-7 setting	-440.00	440.00
	Speed setting	0000h	0002h (32-bit data)	04h		-7200.0	7200.0
IM vector control PM motor control	Torque setting	0002h	0002h (32-bit data)	04h	0.1%/LSB	-300.0	300.0
	Torque bias 1 setting	0004h	0002h (32-bit data)	04h	0.1%/LSB	-300.0	300.0
	Drive torque limiter reduction setting	0006h	0002h (32-bit data)	04h	0.1%/LSB	0.0	100.0
	Regenerative torque limiter reduction setting	0008h	0002h (32-bit data)	04h	0.1%/LSB	0.0	100.0

Function : A value is written into each setting.

This function carries out the same process as the FW command in the standard serial transmission function.

Setting example:

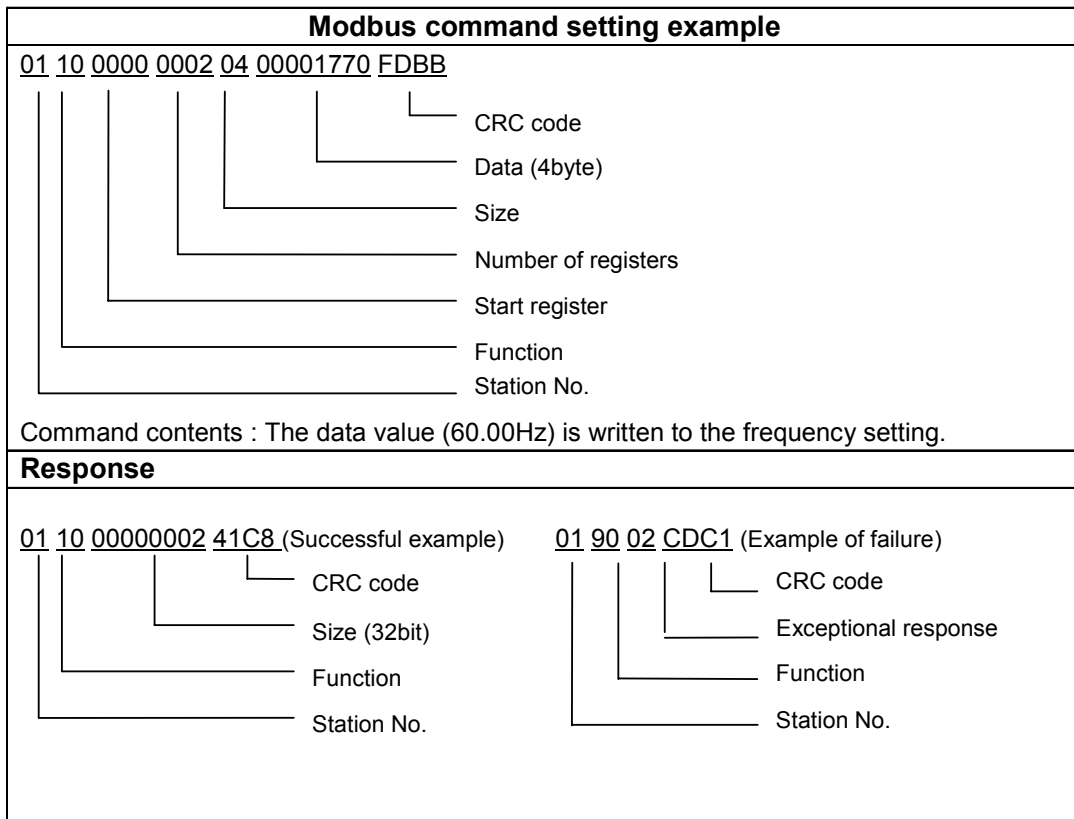

Frequency command/speed command unit

The unit for the frequency command/speed command can be changed with the C26-7: frequency (speed) unit setting. Refer to the 6-1: Parameter list or explanations.

The default setting is C26-7=0: 0.01Hz or 0.1min⁻¹ (signed)

6. Control Functions and Parameter Settings

Details of function	Start register designation	Number of registers	Number of bytes	
Parameter write	03Ebh	0003h (48 bit-data)	06h	The parameter No. and parameter value are set in the data section.

Function : A value is written to the parameter.

This function carries out the same process as the DW command in the standard serial transmission function.

Setting example:

Modbus command setting example

01 10 03EB 0003 06 A0000001388 8981

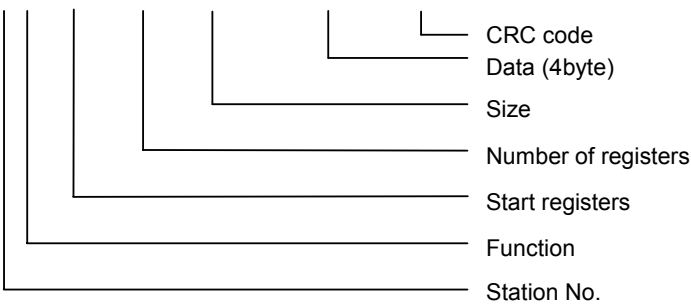

Command contents : The data value (50.00Hz) is written to parameter A00-0.

Response

01 10 03EB 0003 F078(Successful example)

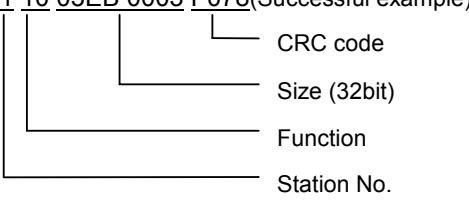

01 90 0B 0DC7 (Example of failure)

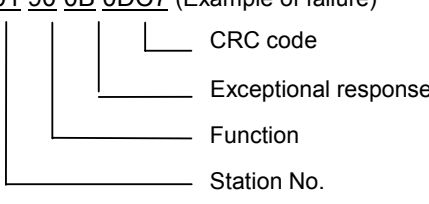

Data setting:

A000	00001388
Parameter designation section	Data designation section

Divide the parameter designation section as shown below and set the parameter No.

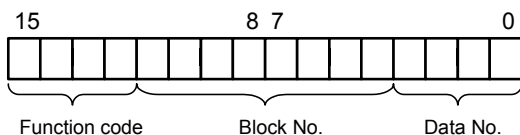

Function	Function code
Block-A parameter designation	A
Block-B parameter designation	B
Block-C parameter designation	C
Block-U parameter designation	E

6. Control Functions and Parameter Settings

◆ Function 17h (Read/Write Multiple Registers)

Details of function	Start register	Number of registers	No. of bytes
Read parameter value	03E9h	0002h (32-bit data)	–
Read parameter No. setting	03E7h	0001h (16-bit data)	02h

Function : The parameter contents are read.

This process carries out the same process as the DR command in the standard serial transmission function.

Setting example:

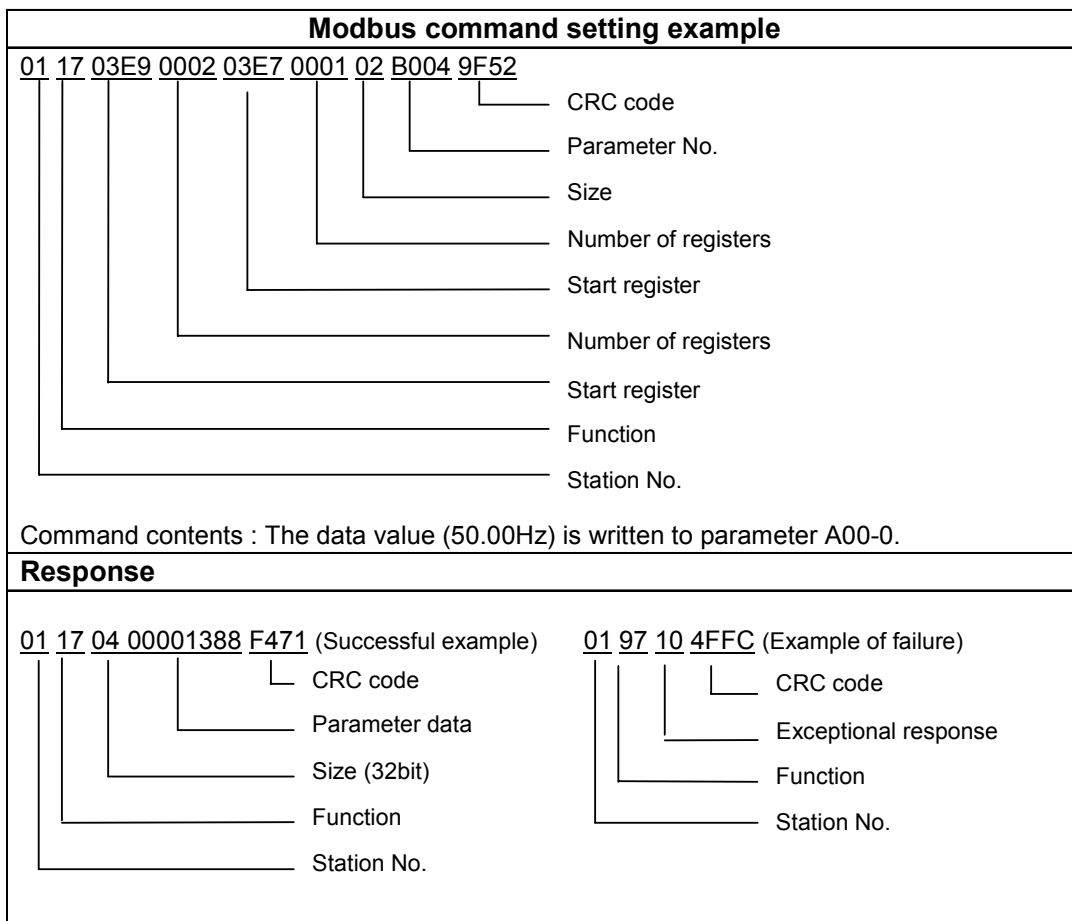

Divide the parameter designation section as shown below and set the parameter No.

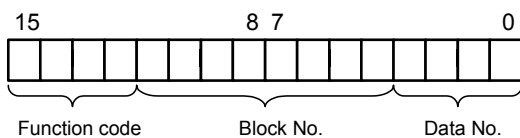

Function	Function code
Block-A parameter designation	A
Block-B parameter designation	B
Block-C parameter designation	C
Block-U parameter designation	E

Chapter 7 Options

7-1 Outline of options

The VT240S Series options include those shown below. This chapter will focus on the stand-alone options and main circuit wiring devices.

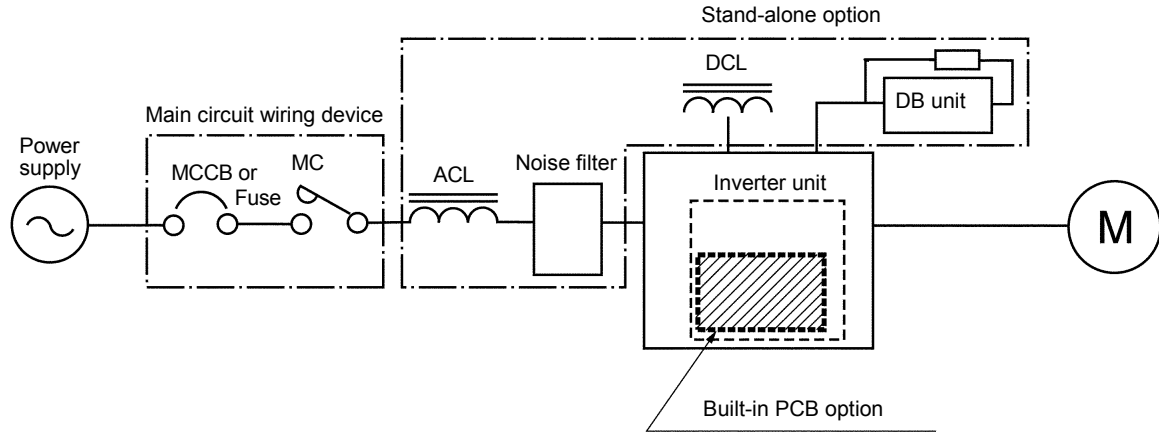

Fig. 7-1 Option configurations

Table 7-1-a

Item	Type	Function
Main circuit wiring devices		
No-fuse breaker (MCCB) or fuse	Select a device that matches the inverter rating. (Refer to Table 7-1-b.) Refer to Chapter 9 when using a UL/cUL compliant product.	Always install this device to protect the wiring of the inverter and peripheral devices.
Magnetic contactor (MC)	Select a device that matches the inverter rating. (Refer to Table 7-1-b.)	Install this device to provide an operation interlock. When using the DB unit, always install this device to protect the DBR. (Refer to Fig. 2-3-a.)
Stand-alone options		
ACL	V21-ACL-□□□□ (Refer to Table 7-1-b.)	If the capacity of the inverter's power supply transformer exceeds 10 times the inverter unit capacity, always install this device to protect the inverter. (Balance with power supply) This is also effective in improving the power factor of the inverter input, in suppressing the current high harmonics and extending the life of the main circuit's electrolytic capacitor. The power factor will be approx. 0.9.
DCL	V21-DCL-□□□□ V24-DCL-□□□□ (Refer to Table 7-1-b.)	Install this device to improve the power factor of the inverter input. This is also effective in creating a balance with the power supply as the ACL. The power factor will be approx. 0.9.
Noise filter	3SUP-□□□□-ER-6 (Refer to Table 7-1-b.)	This device suppresses the electromagnetic noise generated by the inverter. The electromagnetic noise is the radiation of electromagnetic waves in the radio frequency bands and that conveyed to the power supply wires. Mounting of this device is recommended for creating a balance with the peripheral devices of the inverter.
DB unit	V23-DBU-□□ (Refer to Table 7-1-b.)	This is used when the motor is to be stopped with dynamic braking.

7. Options

Table 7-1-a (continued)

Built-in PCB options (These are built-in type options mounted on the basic PCB of the inverter.)				
Item	Type (Instruction manual)	Function	Class	Indication of rating nameplate (Note 1)
Speed detection 1 (complimentary compatible)	V24-DN1 (ST-3480)	This is a speed detection PCB for the complimentary output type encoder. Response frequency: Change between 60±10kHz and 20kHz.	I	1
Speed detection 2 (line driver compatible)	V24-DN2 (ST-3481)	This is a speed detection PCB for the line driver output type encoder. Response frequency: 250kHz (signal: A, B, Z, S phase)	I	2
Speed detection 3 (PM compatible)	V24-DN3 (ST-3482)	This is a speed (pole position) detection PCB for the PM drive control, and is compatible with the line driver output type encoder. Response frequency: 250kHz (signal: A, B, Z, U, V, W phase)	I	3
Speed detection 4 (Note 2)	V24-DN4 (ST-3483)	Speed detection PCB compatible with Heidenhain ERN1387. 1Vp-p 2-phase, 2-set sine wave + Z-phase pulse	I	4
Speed detection 5 In development stages	V24-DN5	Speed detection PCB compatible with line driver serial and synchronous output.	I	5
Relay interface	V24-RY0 (ST-3477)	This is used to expand the contact input/output points. Relay input : 4 points (PS18 to 11) 1c contact output : 4 points (PSO4 to 7)	III	N
Parallel interface In development stages	V24-PI0 (ST-3475)	This is used to receive parallel settings from the PLC. Parallel data input : 16 bits Data length : 16, 12, 8 bits selective Format : Binary or BCD selective Open collector output : 2 points (PSO4, 5)	III	M
Insulated AI/AO (Note 2) In development stages	V24-AI0 (ST-3479)	An insulated 4ch analog input, analog output is possible. Analog input : 16 bits (input range ±10V) Analog output : 12 bits (output range 10V)	II	S
Profibus-DP interface	V24-SL0 (ST-3466)	This is used to make a connection with the network on the Profibus-DP communication protocol. Transmission speed : 12Mbps No. of stations : 126 stations in one network	III	H
CC-Link interface	V24-SL3 (ST-3472)	This is used to make a connection with the CC-Link network. Transmission speed : 156kbps, 625kbps, 2.5Mbps, 5Mbps, 10Mbps (DIP switch settings can be made.) No. of stations : 64 stations in one network	III	K
DeviceNet interface In development stages	V24-SL2 (ST-3470)	This is used to make a connection with the DeviceNet network. Transmission speed : 125kbps, 250kbps, 500kbps (DIP switch settings can be made.) No. of stations : 64 stations in one network	III	J
CANopen interface In development stages	V24-SL1 (ST-3468)	This is used to make a connection with the CANopen network. Transmission speed : 125kbps, 250kbps, 500kbps, 1Mbps (DIP switch settings can be made.) No. of stations : 128 stations in one network	III	I

(Note 1) "0" indicates that the optional PCB is not installed.

(Note 2) The speed detection 4 (V24-DN4) and insulated AI/AO (V24-AIO) cannot be used simultaneously.

7. Options

Table 7-1-b Main circuit wiring device ratings and stand-alone option types (Normal-duty)

Inverter type	Fuse/MCCB/MC Rated current (A) (Note 2)	ACL	DCL	Noise filter	DB unit (Refer to 7-3)
0P7L	15	V21-ACL-LA4T	V24-DCL-LA6	3SUP-HQ10-ER-6	The DB transistor is incorporated as a standard.
1P5L	15	V21-ACL-LA8T	V24-DCL-LA10	3SUP-HQ10-ER-6	
2P2L	15	V21-ACL-LA12T	V24-DCL-LA15	3SUP-HQ20-ER-6	
4P0L	20	V21-ACL-LA18T	V24-DCL-LA22	3SUP-HQ20-ER-6	
5P5L	30	V21-ACL-LA27	V24-DCL-LA32	3SUP-HQ30-ER-6	
7P5L	40	V21-ACL-LA35	V24-DCL-LA45	3SUP-HQ50-ER-6	
011L	60	V21-ACL-LA55	V24-DCL-LA60	3SUP-HB75-ER-6	
015L	80	V21-ACL-LA70	V24-DCL-LA80	3SUP-HB100-ER-6	
018L	100	V21-ACL-LA70	V24-DCL-LA100	3SUP-HB100-ER-6	
022L	125	V21-ACL-LA90	V24-DCL-LA120	3SUP-HK150-ER-6B	
030L	150	V21-ACL-LA140	V24-DCL-LA150	3SUP-HK150-ER-6B	V23-DBU-L3
037L	200	V21-ACL-LA180	V24-DCL-LA180	3SUP-HK200-ER-6B	V23-DBU-L4
045L	225	V21-ACL-LA200	V24-DCL-LA220	3SUP-HK250-ER-6B	
055L	300	V21-ACL-LA260	V21-DCL-LA270	3SUP-HP500-ER-6	
075L	400	V21-ACL-LA320	V21-DCL-LA350	3SUP-HP500-ER-6	
090L	500	V21-ACL-LA400	V21-DCL-LA410	3SUP-HP500-ER-6	
0P7H	15	V21-ACL-HA3T	V24-DCL-HA3	3SUP-HQ10-ER-6	The DB transistor is incorporated as a standard.
1P5H	15	V21-ACL-HA4T	V24-DCL-HA5	3SUP-HQ10-ER-6	
2P2H	15	V21-ACL-HA6T	V24-DCL-HA8	3SUP-HQ10-ER-6	
4P0H	15	V21-ACL-HA10T	V24-DCL-HA12	3SUP-HQ20-ER-6	
5P5H	20	V21-ACL-HA14T	V24-DCL-HA18	3SUP-HQ20-ER-6	
7P5H	25	V21-ACL-HA18T	V24-DCL-HA25	3SUP-HQ30-ER-6	
011H	30	V21-ACL-HA27	V24-DCL-HA32	3SUP-HQ30-ER-6	
015H	40	V21-ACL-HA35	V24-DCL-HA40	3SUP-HQ50-ER-6	
018H	50	V21-ACL-HA35	V24-DCL-HA50	3SUP-HQ50-ER-6	
022H	60	V21-ACL-HA45	V24-DCL-HA60	3SUP-HB75-ER-6	
030H	80	V21-ACL-HA70	V24-DCL-HA75	3SUP-HB100-ER-6	V23-DBU-H3
037H	100	V21-ACL-HA90	V24-DCL-HA90	3SUP-HB100-ER-6	V23-DBU-H4
045H	125	V21-ACL-HA90	V24-DCL-HA110	3SUP-HK150-ER-6B	
055H	150	V21-ACL-HA110	V24-DCL-HA140	3SUP-HK150-ER-6B	
075H	200	V21-ACL-HA150	V21-DCL-HA180	3SUP-HK200-ER-6B	
090H	225	V21-ACL-HA180	V21-DCL-HA210	3SUP-HK250-ER-6B	
110H	300	V21-ACL-HA210	V21-DCL-HA270	3SUP-HP500-ER-6	
132H	350	V21-ACL-HA300	V21-DCL-HA310	3SUP-HP500-ER-6	
160H	400	V21-ACL-HA360	V21-DCL-HA400	3SUP-HP500-ER-6	
200H	500	V21-ACL-HA460	V21-DCL-HA540	3SUP-HP500-ER-6	
250H	600	V21-ACL-HA520	V21-DCL-HA650	3SUP-HP700-ER-6	
315H	800	V21-ACL-HA580	V21-DCL-HA740	3SUP-HP500-ER-6 × 2 units	V23-DBU-H4 × 2 units
400H	1000	V21-ACL-HA700	V21-DCL-HA970	3SUP-HP500-ER-6 × 2 units	V23-DBU-H4 × 3 units
475H	1200	V21-ACL-HA900	V21-DCL-HA1200	3SUP-HP700-ER-6 × 2 units	

7. Options

Table 7-1-b Main circuit wiring device ratings and stand-alone option types (Heavy-duty)

Inverter type	Fuse/MCCB/MC Rated current (A) (Note 2)	ACL	DCL	Noise filter	DB unit (Refer to 7-3)
0P7L	15	V21-ACL-LA4T	V24-DCL-LA6	3SUP-HQ10-ER-6	The DB transistor is incorporated as a standard.
1P5L	15	V21-ACL-LA4T	V24-DCL-LA10	3SUP-HQ10-ER-6	
2P2L	15	V21-ACL-LA8T	V24-DCL-LA15	3SUP-HQ20-ER-6	
4P0L	20	V21-ACL-LA12T	V24-DCL-LA22	3SUP-HQ20-ER-6	
5P5L	30	V21-ACL-LA18T	V24-DCL-LA32	3SUP-HQ30-ER-6	
7P5L	35	V21-ACL-LA27	V24-DCL-LA45	3SUP-HQ50-ER-6	
011L	50	V21-ACL-LA35	V24-DCL-LA60	3SUP-HB75-ER-6	
015L	70	V21-ACL-LA55	V24-DCL-LA80	3SUP-HB100-ER-6	
018L	90	V21-ACL-LA70	V24-DCL-LA100	3SUP-HB100-ER-6	
022L	125	V21-ACL-LA70	V24-DCL-LA120	3SUP-HK150-ER-6B	V23-DBU-L2
030L	125	V21-ACL-LA90	V24-DCL-LA150	3SUP-HK150-ER-6B	V23-DBU-L3
037L	150	V21-ACL-LA140	V24-DCL-LA180	3SUP-HK200-ER-6B	
045L	200	V21-ACL-LA180	V24-DCL-LA220	3SUP-HK250-ER-6B	V23-DBU-L4
055L	225	V21-ACL-LA200	V24-DCL-LA270	3SUP-HP500-ER-6	
075L	300	V21-ACL-LA260	V21-DCL-LA350	3SUP-HP500-ER-6	
090L	400	V21-ACL-LA320	V21-DCL-LA410	3SUP-HP500-ER-6	
0P7H	15	V21-ACL-HA3T	V24-DCL-HA3	3SUP-HQ10-ER-6	The DB transistor is incorporated as a standard.
1P5H	15	V21-ACL-HA3T	V24-DCL-HA5	3SUP-HQ10-ER-6	
2P2H	15	V21-ACL-HA4T	V24-DCL-HA8	3SUP-HQ10-ER-6	
4P0H	15	V21-ACL-HA6T	V24-DCL-HA12	3SUP-HQ20-ER-6	
5P5H	15	V21-ACL-HA10T	V24-DCL-HA18	3SUP-HQ20-ER-6	
7P5H	20	V21-ACL-HA14T	V24-DCL-HA25	3SUP-HQ30-ER-6	
011H	25	V21-ACL-HA18T	V24-DCL-HA32	3SUP-HQ30-ER-6	
015H	35	V21-ACL-HA27	V24-DCL-HA40	3SUP-HQ50-ER-6	
018H	50	V21-ACL-HA35	V24-DCL-HA50	3SUP-HQ50-ER-6	
022H	60	V21-ACL-HA35	V24-DCL-HA60	3SUP-HB75-ER-6	V23-DBU-H2
030H	70	V21-ACL-HA45	V24-DCL-HA75	3SUP-HB100-ER-6	
037H	80	V21-ACL-HA70	V24-DCL-HA90	3SUP-HB100-ER-6	V23-DBU-H3
045H	100	V21-ACL-HA90	V24-DCL-HA110	3SUP-HK150-ER-6B	
055H	125	V21-ACL-HA90	V24-DCL-HA140	3SUP-HK150-ER-6B	V23-DBU-H4
075H	150	V21-ACL-HA110	V24-DCL-HA180	3SUP-HK200-ER-6B	
090H	200	V21-ACL-HA150	V21-DCL-HA210	3SUP-HK250-ER-6B	
110H	225	V21-ACL-HA180	V21-DCL-HA270	3SUP-HP500-ER-6	
132H	300	V21-ACL-HA210	V21-DCL-HA310	3SUP-HP500-ER-6	
160H	350	V21-ACL-HA300	V21-DCL-HA400	3SUP-HP500-ER-6	
200H	400	V21-ACL-HA360	V21-DCL-HA540	3SUP-HP500-ER-6	
250H	500	V21-ACL-HA460	V21-DCL-HA650	3SUP-HP700-ER-6	
315H	700	V21-ACL-HA520	V21-DCL-HA740	3SUP-HP500-ER-6 × 2 units	V23-DBU-H4 × 2 units
400H	800	V21-ACL-HA580	V21-DCL-HA970	3SUP-HP500-ER-6 × 2 units	
475H	1000	V21-ACL-HA700	V21-DCL-HA1200	3SUP-HP700-ER-6 × 2 units	

(Note 1) Device selection conditions

- The input current is calculated as follows: $I = (IMkW)/\eta_{IM}/\eta_{INV}/\text{COS}\phi/\text{voltage}/\sqrt{3}$
- The η_{IM} (motor efficiency) is 0.85 for 11kW or less, 0.9 for 15kW or more.
- The η_{INV} (inverter efficiency) is 0.95.
- COS ϕ is 0.5 to 0.6 at the input power factor. When using ACL or DCL, recalculate as 0.9.
- The power supply voltage is 200V/380V. (If the power supply voltage differs, recalculate and select.)

(Note 2) When complying with UL/cUL, use a UL certified fuse or UL certified no-fuse breaker (MCCB) as indicated in section 9-1.

7-2 Built-in PCB option

This is a built-in type option mounted on the VT240S control PCB.

One type can be selected from option I, option II and option III. Up to three types of PCB options can be mounted at once.

These PCB options are connected to the connector on the VT240S control PCB, and can be easily mounted even after purchasing the VT240S.

Refer to each instruction manual for details on the PCB options.

* A dedicated PCB mounting jig is required when mounting the PCB option II and III at the same time.

7-2-1 Option classes

(1) Option I

This is the PCB option for speed detection 1 to 4. The mounting position I is fixed.

(2) Option II

This is the PCB option for the Insulated AI/AO interface, etc. The mounting position is position II.

(3) Option III

This is the PCB option for the relay interface, Serial communication etc. The mounting position is position III.

(Position III is PCB mounted on the PCB option at position II.)

Refer to Table 7-1-a for the detailed option classes.

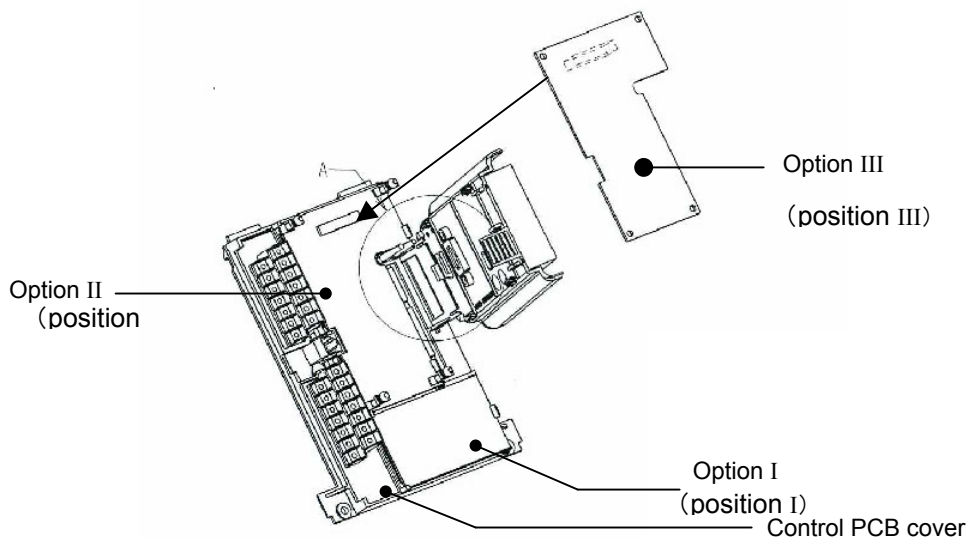

Built-in PCB option mounting drawing

Notes for moving Operation panel folder

Do not raise the operation panel folder with an angle of larger than 70° , so that the folder should not be fallen off.

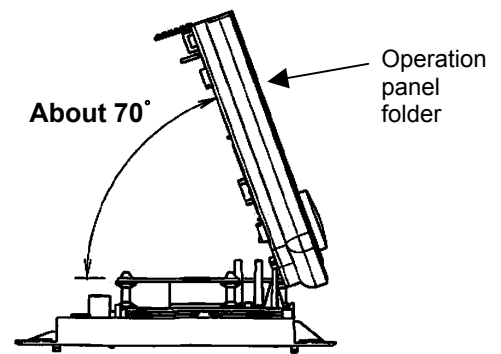

If the operation panel folder should be taken off, push the hinges of the folder lightly and insert them into the original positions.

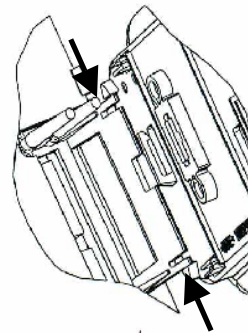

7-3 Dynamic braking (DB) option

The VT240S has a dynamic braking option.

Note) When Unit built-in DBR is used, set the DBR overload protection parameter (C22-4) to less than the actual used %ED (Max. 10.0). When the external DB unit is used, set C22-4 to 0.0.

7-3-1 Built-in DB circuit 018L/022H and smaller

The DB transistor is built in as a standard for the 018L/022H and smaller capacities.

For the 011L/015H and smaller capacities, the DB resistor (DBR) can be built in as an option.

When using the DB, use at 10%ED or less as shown in Fig. 7-3-1-a.

When using the dynamic braking option, set the Regenerative current limit (B18-1) and the DB option selection (C31-0 \square).

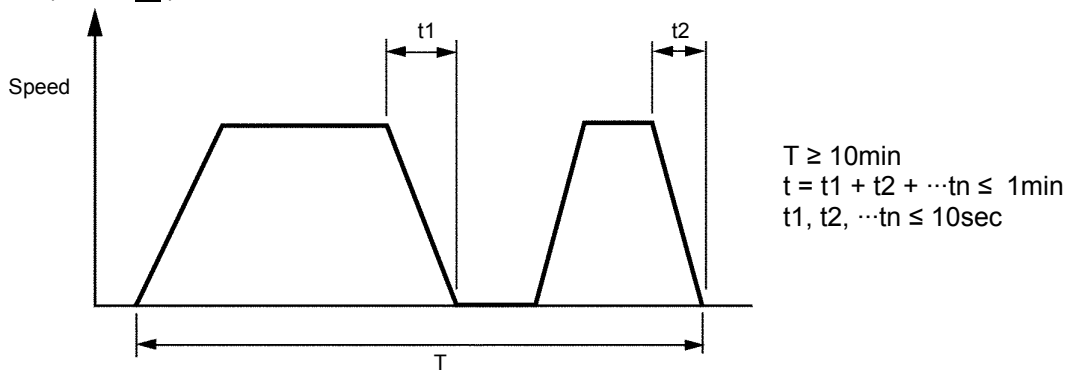

Fig. 7-3-1-a

(1) Unit built-in DBR

The specification of DBR built into the unit is shown in Table 7-3-1-a. If these resistors are applied, use within t(sec) shown in Table 7-3-1-a.

Table 7-3-1-a Unit built-in DBR

Inverter type VT240S-□	Resistance capacity (W)	Built-in DBR (Ω)	Heavy-duty		Normal-duty		t (sec) (Note 1)
			Motor capacity (kW)	Braking torque (%)	Motor capacity (kW)	Braking torque (%)	
0P7L	120	220	0.4	200	0.75	110	30
1P5L	120	220	0.75	110	1.5	55	30
2P2L	120	220	1.5	55	2.2	35	30
4P0L	120	180	2.2	45	4.0	25	20
5P5L	120	110	4.0	40	5.5	30	10
7P5L	120	91	5.5	35	7.5	25	10
011L	120	91	7.5	25	11	15	10
0P7H	120	430	0.4	340	0.75	220	10
1P5H	120	430	0.75	220	1.5	130	10
2P2H	120	430	1.5	130	2.2	75	10
4P0H	120	430	2.2	75	4.0	40	10
5P5H	120	430	4.0	40	5.5	30	10
7P5H	120	430	5.5	30	7.5	20	10
011H	120	430	7.5	20	11	15	10
015H	120	430	11	15	15	10	10

(Note 1) Set C22-4 to $[t / 600\text{sec}] \times 100\%$.

7. Options

(2) External DB resistor

If the braking torque is insufficient with the above built-in resistor, provide an external DB resistor with a circuit as shown in Fig. 7-3-1-b. When using an external DB resistor, remove the built-in DB resistor. The resistance value and usable minimum resistance value to obtain a 100% braking torque is shown in Table 7-3-1-b.

When using the external DB resistor, use of a burning prevention circuit, including the thermal relay (76D) shown in Fig. 7-3-1-b. is recommended.

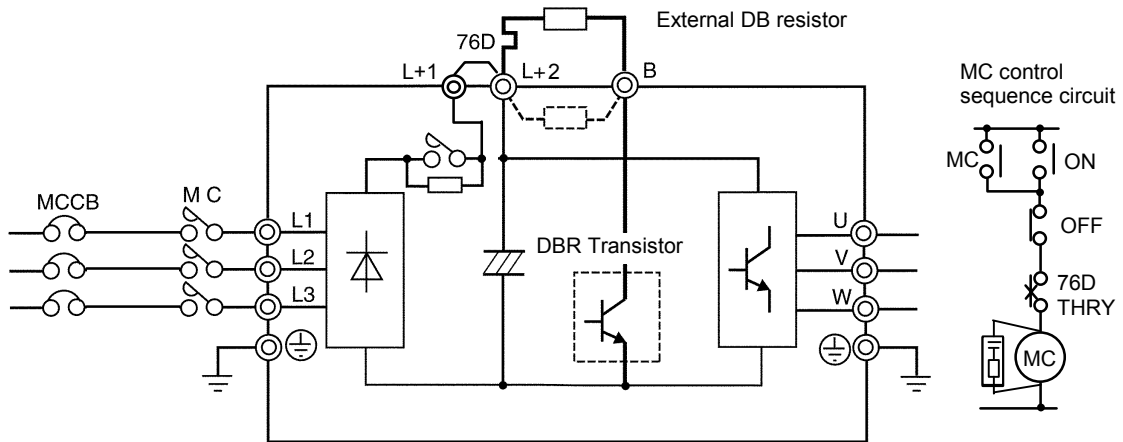

Fig. 7-3-1-b DBR circuit

Table 7-3-1-b External DBR

Inverter type VT240S-□	Min. resistance value (Ω)	Heavy-duty		Normal-duty	
		Motor capacity (kW)	100% braking resistance value (Ω)	Motor capacity (kW)	100% braking resistance value (Ω)
0P7L	40	0.4	460	0.75	240
1P5L	40	0.75	240	1.5	120
2P2L	40	1.5	120	2.2	84
4P0L	18	2.2	84	3.7	46
5P5L	18	4.0	46	5.5	33
7P5L	13	5.5	33	7.5	24
011L	8	7.5	24	11	16
015L	7	11	16	15	12
018L	6	15	12	18	10
0P7H	100	0.4	1850	0.75	980
1P5H	100	0.75	980	1.5	490
2P2H	100	1.5	490	2.2	330
4P0H	100	2.2	330	3.7	180
5P5H	70	4.0	180	5.5	130
7P5H	50	5.5	130	7.5	98
011H	50	7.5	98	11	67
015H	30	11	67	15	49
018H	20	15	49	18	41
022H	20	18	41	22	33

7-3-2 External DB unit 022L/030H and higher

Use an external DB unit when carrying out dynamic braking with the 022L/030H and larger unit. Applicable DB unit, the resistance value and usable minimum resistance value to obtain a 100% braking torque is shown in Table 7-3-2.

Connect the DB unit as shown in Fig. 7-3-2. When carrying out dynamic braking with one DB unit, use at 10%ED or less as shown in Fig. 7-3-1-a. If the braking torque is insufficient with one unit, connect a DB unit in parallel.

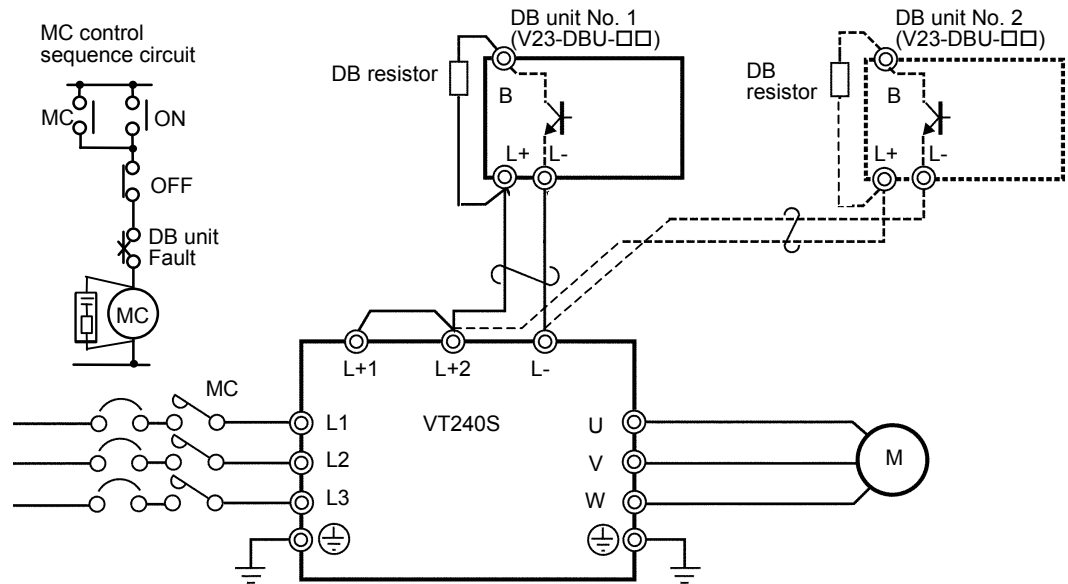

Fig. 7-3-2 DB unit connection

7. Options

Table 7-3-2 External DB unit

Inverter type VT240S-□	Heavy-duty				Normal-duty			
	Motor capacity (kW)	DB unit type	Min. resistance value (Ω)	100% braking resistance value (Ω)	Motor capacity (kW)	DB unit type	Min. resistance value (Ω)	100% braking resistance value (Ω)
022L	18	V23-DBU-L2	5.7	9.3	22	V23-DBU-L2	5.7	7.8
030L	22			7.8	30	V23-DBU-L3		5.7
037L	30	V23-DBU-L3	3.8	5.7	37	V23-DBU-L3	3.8	4.7
045L	37			4.7	45			3.8
055L	45	V23-DBU-L4	1.5	3.8	55	V23-DBU-L4	1.5	3.1
075L	55			3.1	75			2.3
090L	75			2.3	90			1.9
030H	22	V23-DBU-H2	23	31.4	30	V23-DBU-H3	15	23.0
037H	30	V23-DBU-H3	15	23.0	37	V23-DBU-H3	15	18.6
045H	37			18.6	45			15.3
055H	45	V23-DBU-H4	3.3	15.3	55	V23-DBU-H4	3.3	12.5
075H	55			12.5	75			9.2
090H	75			9.2	90			7.7
110H	90			7.7	110			6.3
132H	110			6.3	132			5.2
160H	132			5.2	160			4.3
200H	160			4.3	200			3.4
250H	200			3.4	250			5.6 × 2 sets
315H	250			5.6 × 2 sets	315			4.4 × 2 sets
400H	315			4.4 × 2 sets	400			3.4 × 2 sets
475H	400	V23-DBU-H4 × 2 units		3.4 × 2 sets	475	V23-DBU-H4 × 3 units		4.5 × 3 sets

- (1) Set the following parameters when using external DB unit.

C31-0 f_1 = 2 : With DB

B18-1 = 100% : Regenerative current limit

B22-5 = 100% : Regenerative current limit (Auxiliary drive0)

B26-5 = 100% : Regenerative current limit (Auxiliary drive1)

B2A-5 = 100% : Regenerative current limit (Auxiliary drive2)

B2E-5 = 100% : Regenerative current limit (Auxiliary drive3)

- (2) Obtain the power generation capacity and DBR resistance value with the following expressions.

$$\text{Power generation capacity (kW)} = \frac{\text{Regenerative torque}}{\text{Motor rated torque}} \times 0.85 \times \text{Motor capacity (kW)}$$

$$\text{DBR resistance value} = \frac{K}{\text{Power generation capacity}}$$

Note that for the 200V Series, K = 148.2

For the 400V Series, K = 593

7-4 ACL and DCL

Select the ACL and DCL according to the Table 7-1-b inverter type. Refer to Table 7-4-a, Table 7-4-b and Table 7-4-c for the outline dimension. The ACL is equivalent to a 3% impedance of the inverter capacity.

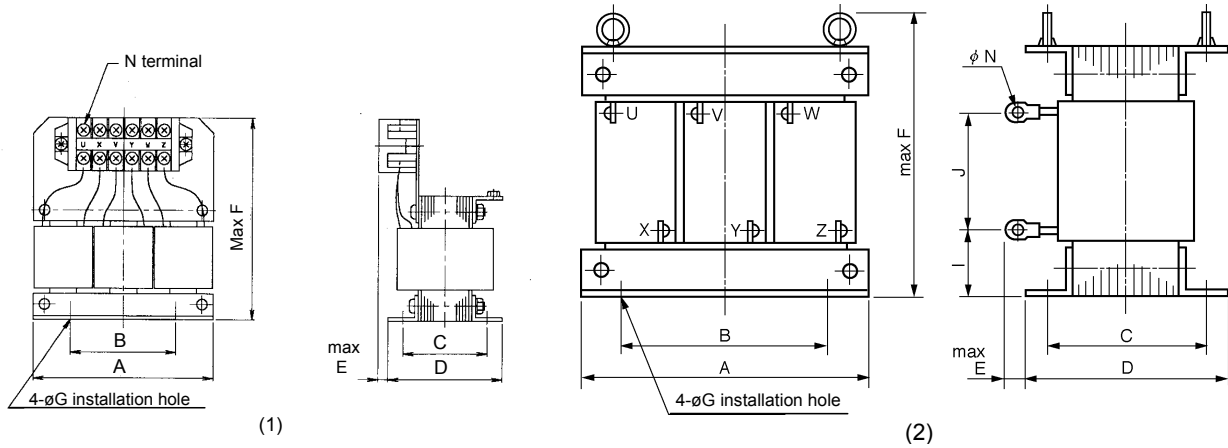

Fig. 7-4-a Outline of ACL

Table 7-4-a Outline dimensions of ACL (Outline : Fig. 7-4-a)

INV type VT240S-□	Dimensions (mm)										Weight (kg)	Shape class
	A	B	C	D	E	F	G	I	J	N		
0P7L	170	100	70	85	2	150	8	-	-	M4	4	(1)
1P5L	170	100	70	85	2	160	8	-	-	M4	4	
2P2L	170	100	70	85	2	165	8	-	-	M4	5	
4P0L	170	100	70	85	2	175	8	-	-	M4	5	
5P5L	170	100	70	85	50	130	8	35	60	5.3	6	(2)
7P5L	170	100	70	85	50	130	8	35	60	6.4	6	
011L	190	100	75	105	60	155	8	40	70	6.4	10	
015L	190	100	75	105	80	180	8	40	80	6.4	11	
018L	190	100	75	105	80	180	8	40	80	6.4	11	
022L	220	150	90	115	80	180	8	50	80	8.4	13	
030L	220	150	90	115	80	210	8	50	100	10.5	18	
037L	270	200	110	150	80	240	11	50	100	10.5	25	
045L	270	200	110	150	100	260	11	50	110	10.5	28	
055L	270	200	110	150	100	270	11	50	120	10.5	30	
075L	300	200	140	180	120	290	11	60	120	13	45	
090L	300	200	140	180	120	300	11	60	120	13	46	

7. Options

Table 7-4-a (continued) Outline dimensions of ACL (Outline : Fig. 7-4-a)

INV type VT240S-□	Dimensions (mm)										Weight (kg)	Shape class
	A	B	C	D	E	F	G	I	J	N		
0P7H	170	100	70	85	2	150	8	-	-	M4	4	(1)
1P5H	170	100	70	85	2	155	8	-	-	M4	4	
2P2H	170	100	70	85	2	165	8	-	-	M4	4	
4P0H	170	100	75	95	2	170	8	-	-	M4	6	
5P5H	170	100	75	95	2	175	8	-	-	M4	6	
7P5H	170	100	75	95	2	190	8	-	-	M4	6	
011H	190	100	75	105	50	160	8	40	75	5.3	9	
015H	190	100	75	105	50	160	8	40	70	6.4	9	
018H	190	100	75	105	50	160	8	40	70	6.4	9	
022H	220	150	90	115	50	160	8	50	75	6.4	13	
030H	220	150	90	115	80	185	8	50	90	6.4	16	
037H	270	200	110	150	80	240	11	50	95	8.4	25	
045H	270	200	110	150	80	240	11	50	95	8.4	25	
055H	270	200	110	150	80	240	11	50	95	8.4	27	
075H	300	200	140	180	80	260	11	60	95	10.5	43	
090H	300	200	140	180	80	280	11	65	105	10.5	45	
110H	330	200	140	180	110	270	11	65	100	10.5	50	
132H	350	240	160	210	120	310	15	65	110	13	65	
160H	350	240	160	210	150	320	15	65	120	13	70	
200H	370	280	160	210	150	370	15	70	170	13	100	
250H	370	280	160	210	150	390	15	70	190	13	100	
315H	370	280	160	210	150	410	15	70	210	17	110	

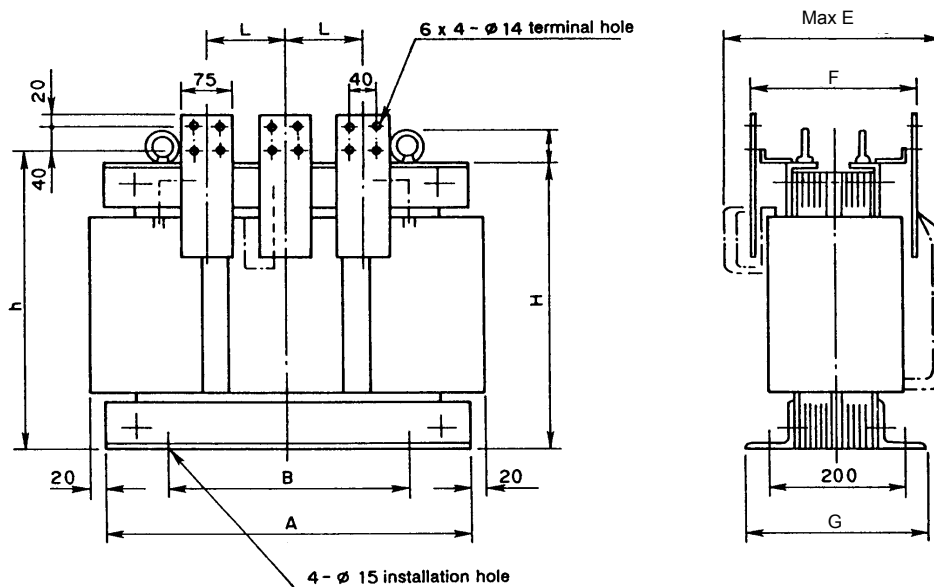

Fig. 7-4-b Outline of ACL

Table 7-4-b Outline dimensions of ACL (Outline : Fig. 7-4-b)

INV type VT240S -□	Dimensions (mm)											Weight (kg)
	A	B	L	H	h	C	D	E	F	G	I	
400H	500	350	150	410	450	20	75	440	300	262	51	165
475H	500	350	150	430	460	20	75	440	300	262	51	170

7. Options

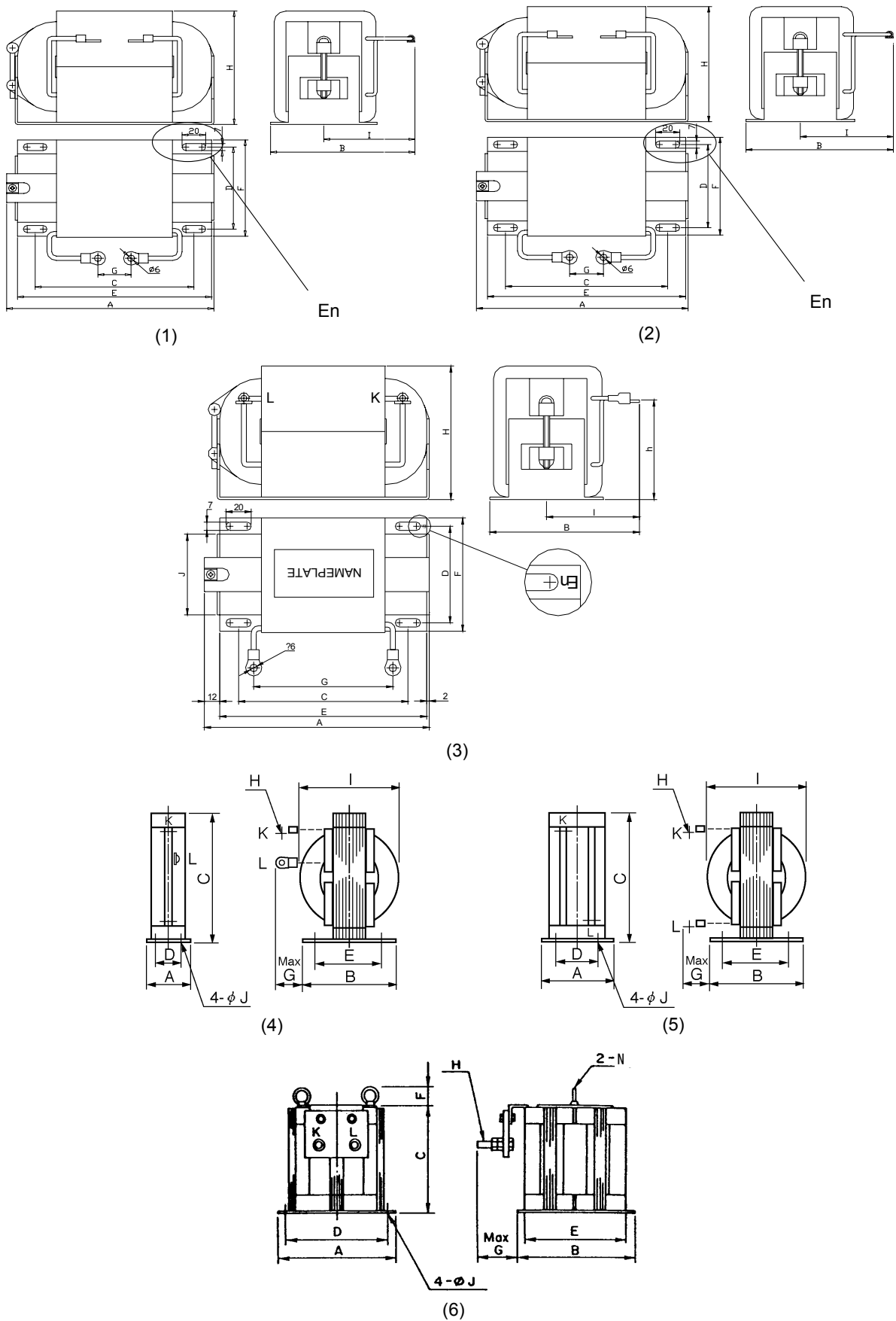
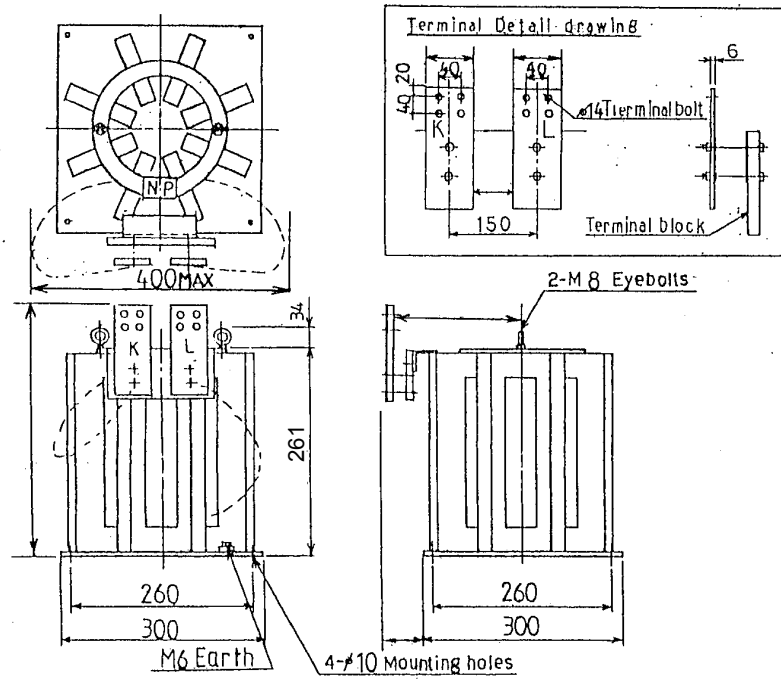
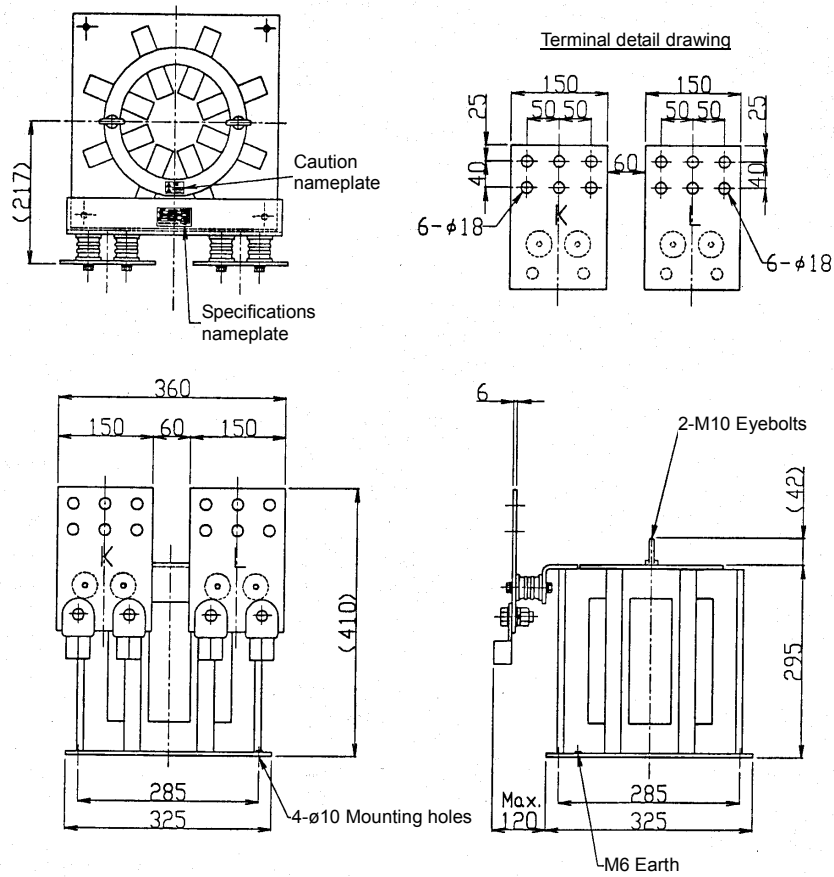

Fig. 7-4-c Outline of DCL

7. Options



(7)



(8)

7. Options

Table 7-4-c Outline dimensions of DCL: Small to medium size capacities (Outline: Fig. 7-4-c)

INV type VT240S-□	Dimensions (mm)											Weight (kg)	Shape class
	A	B	C	D	E	F	G	H	I	J	h		
0P7L	104	130	70	38	85	50	20	70	105	-	-	1.1	(1)
1P5L	109	135	75	43	90	55	20	70	108	-	-	1.2	
2P2L	99	135	65	40	80	55	20	80	108	-	-	1.2	
4P0L	119	135	80	40	100	55	20	90	108	-	-	1.5	
5P5L	112	145	73	50	93	65	20	90	113	-	-	1.9	
7P5L	119	150	80	53	100	70	20	100	115	-	-	2.1	
011L	129	152	85	51	110	72	20	124	116	-	-	2.6	
015L	129	162	85	66	110	82	20	104	121	-	-	3.3	
018L	149	155	95	63	130	75	20	120	118	100	100	4.3	(3)
022L	159	155	100	63	140	85	20	130	118	105	110	5.1	
030L	159	165	100	73	140	85	20	130	123	105	110	6.1	
037L	154	180	95	85	135	100	20	140	130	100	110	7.2	
045L	154	190	95	95	135	110	20	140	135	100	110	8.1	

Table 7-4-c Outline dimensions of DCL (Outline: Fig. 7-4-c)

INV type VT240S-□	Dimensions (mm)											Weight (kg)	Shape class
	A	B	C	D	E	F	G	H	I	J	h		
0P7H	104	130	70	38	85	50	20	70	105	-	-	1.0	(2)
1P5H	109	135	75	43	90	55	20	70	108	-	-	1.2	
2P2H	119	135	80	40	100	55	20	90	108	-	-	1.4	
4P0H	112	145	73	50	93	65	20	90	113	-	-	1.8	
5P5H	119	150	80	53	100	70	20	100	115	-	-	2.1	
7P5H	129	152	85	51	110	72	20	124	116	-	-	2.6	
011H	129	162	85	66	110	82	20	104	121	-	-	3.2	
015H	119	168	75	69	100	88	20	116	124	-	-	3.3	
018H	124	175	75	73	105	95	20	140	128	-	-	3.9	
022H	124	175	75	73	105	95	20	140	128	-	-	4.0	
030H	149	165	95	68	130	85	20	140	123	100	120	5.1	(3)
037H	149	170	95	70	130	90	20	150	125	100	120	5.4	
045H	159	175	100	78	140	95	20	150	128	120	120	6.8	
055H	159	195	100	98	140	115	20	150	138	120	120	8.8	

7. Options

Table 7-4-c Outline dimensions of DCL : Large capacity (Outline: Fig. 7-4-c)

INV type VT240S-□	Dimensions (mm)											Weight (kg)	Shape class
	A	B	C	D	E	F	G	H	I	J	N		
055L	75	140	307	55	120	–	120	M12	254	7	–	15	(4)
075L	120	140	303	100	120	–	135	M12	240	7	–	21	(5)
090L	120	140	321	100	120	–	150	M12	256	7	–	25	

Table 7-4-c Outline dimensions of DCL : Large capacity : Fig. 7-4-c)

INV type VT240S-□	Dimensions (mm)											Weight (kg)	Shape class
	A	B	C	D	E	F	G	H	I	J	N		
075H	120	140	281	100	120	–	120	M10	228	7	–	18	(5)
090H	120	140	299	100	120	–	120	M10	246	7	–	23	
110H	120	140	289	100	120	–	120	M12	236	7	–	23	
132H	120	140	333	100	120	–	135	M12	270	7	–	23	
160H	225	225	216	195	195	34	120	M12	–	10	M8	25	(6)
200H	250	250	215	210	210	34	120	M16	–	10	M8	28	
250H	275	275	201	235	235	34	120	M16	–	10	M8	32	
315H	275	275	236	235	235	34	120	M16	–	10	M8	35	

Table 7-4-c Outline dimensions of DCL: Large capacity (Outline: Fig. 7-4-c)

INV type VT240S-□	Dimensions (mm)						Weight (kg)	Shape class
	A	B	C	D	E	F		
400H	300	300	261	260	260	34	50	(7)
475H	300	300	282	260	260	34	60	(8)

7-5 EMI filter

An EMI filter is prepared for the VT240S. Select the NF from Table 7-1-b according to inverter type.

7-5-1 030H and smaller, 5P5L and smaller

The EMI filter can be built into the unit as an option. The leakage current is 60mA or less at 480V/50Hz, and 70mA or less at 240V/50Hz.

The inverter will comply with the European EMC Standards (EN61800-3 First Environment Category C2) when the EMI filter is built in.

Note) 7P5H and higher and 4POL and higher are compatible with the EMC Standards (EN61800-3 Second Environment Category C3).

Note) The leakage current is based on the assumption that one wire is disconnected in a 3-phase circuit.

Note) Make sure that the motor wire length is 10m or less. A standalone EMI filter should be connected if the distance exceeds 10m.

To provide measures against conductive noise, use a built-in and standalone EMI filter. The inverter will comply with the EMC Standards (EN61800-3 First Environment Category C1) when a built-in and standalone filter are used.

7-5-2 037H and higher, 7P5L and higher

To provide measures against noise for the 037H and higher or 7P5L and higher unit, use a standalone EMI filter. Refer to Table 7-1-b for details. The inverter will comply with the EMC Standards (EN61800-3 Second Environment Category C3) when a standalone EMI filter is used.

Chapter 8 Maintenance and Inspection

 **DANGER**

- Always wait at least 20 minutes after turning the input power OFF before starting inspections. Wait at least 20 minutes after turning the input power OFF before starting work. Make sure that the displays on the operation panel have gone out before removing the front cover. Remove the front cover, and confirm that the "CHARGE" LED in the unit has gone out. Also check that the voltage between L+1 or L+2 and L- is 15V or less before starting the inspections. Failure to observe this could lead to electric shocks.
- Maintenance, inspections and part replacement must be done by a designated person. (Remove all metal accessories such as watches, bracelets, etc., before starting the work.) (Always use an insulation measure tool.) Failure to observe this could lead to electric shocks and injuries.
- Always turn the power OFF before inspecting the motor or machine. A potential is applied on the motor terminal even when the motor is stopped. Failure to do so could lead to electric shocks and injuries.
- Do not use parts other than those designated for the replacement parts. Contact your inverter dealer for replacement parts. Failure to observe this could lead to fires.

 **CAUTION**

- Vacuum the inverter with a vacuum cleaner to clean it. Do not use water or organic solvents. Failure to observe this could lead to fires or damage.

8-1 Inspection items

The inspection must be carried out periodically. Determine the cycle according to the installation environment and working frequency of the VT240S. If there are any abnormalities, the cause must be inspected immediately and countermeasures taken.

(1) Daily inspections

Table 8-1-a

Inspection item	Inspection details and work
Temperature/humidity	Confirm that the ambient temperature is -10 to 50°C, and that the humidity is 95% or less with no dew condensation.
Oil mist, dust and corrosive gas	Confirm that there is no oil mist, dust or corrosive gas, etc., in the VT240S.
Abnormal noise and vibration	Confirm that there is no abnormal noise or vibration from the installation site or VT240S.
Input power source	Confirm that the input voltage and frequency are within the specifications range.
Cooling fan	Confirm that the cooling fan rotates normally and that no lint, etc. is stuck on it.
Indicator	Confirm that all lamps on the operation panel light properly.

8. Maintenance and Inspection

(2) Periodic inspections

Table 8-1-b

Inspection item	Inspection details and work
VT240S appearance	Check the state of dirt and dust on the vent or heatsink, and clean if necessary.
VT240S interior	Check the state of dirt and dust on the PCB and inside the equipment, and clean if necessary.
Terminal block	Tighten the terminal block screws if loose.
Cooling fan	Replace the fan every three years.
Electrolytic capacitor	Confirm that there is no liquid leaking or sheath discoloration. Please exchange electrolytic capacitors of a main circuit for about five years. (When the average annual temperature of the panel in which the VT240S is stored is 25°C or less. Please consult our company when it is used in the environment for the average temperature to exceed 25°C during year.)
Insulation test	An insulation test has been completed at the factory, so avoid performing a megger test on the VT240S when possible. If unavoidable, follow (Note 1) . Contact Meidensha when a pressure test is required.
Encoder	Confirm that there is no looseness or play in the bearings or couplings. The bearings are durable parts. This is approx. 10,000 hours at 6000rpm, and approx. 30,000 hours at 3000rpm. They must be replaced periodically.

(Note 1) Use the following procedures when an insulation test must be carried out. Pay special care as an incorrect test could damage the product.

• **Megger test of main circuit**

- 1) Turn OFF the power to all circuits connected to the VT240S, and confirm that the operation panel display has turned OFF. Then, remove the front cover.
Confirm that the "CHARGE" LED on the PCB has gone out, and that the voltage between L+1, L+2 and L- (if unit capacity does not have L-, negative pole of main circuit electrolytic capacitor) is completely discharged.
- 2) Short-circuit the main circuit terminals in a batch as shown in Fig. 8-1. If the unit capacity does not have an L- terminal, add the main circuit electrolytic capacitor negative pole to the batch short-circuit.
If the test voltage could be applied on the control circuit, disconnect the control terminal block wiring.
- 3) Carry out the megger test at 500VDC. Connect the + pole of the megger tester to where the main circuit is short-circuited in a batch, and connect the - pole to the ground (grounding terminal), so that the test voltage is not applied on the other circuits.
- 4) When the VT240S isolated, the state is normally if the megger measurement results are 1MΩ or more.

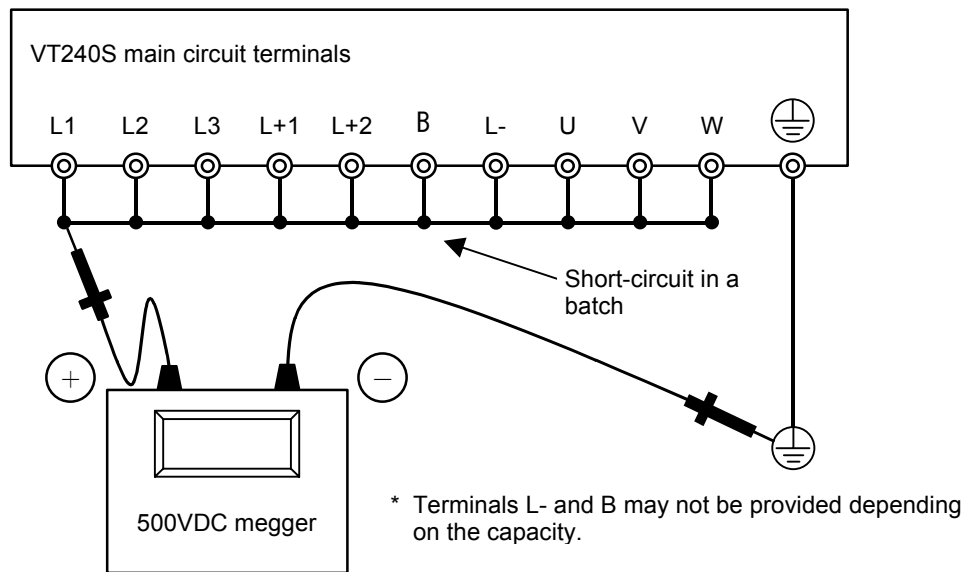

Fig. 8-1 Main circuit megger test

• Testing the control circuit's insulation

Test the control circuit's insulation with the tester's high-resistance range. Never perform a megger test or pressure test.

- 1) Turn OFF the power to all circuits connected to the VT240S, and confirm that the operation panel display has turned OFF. Then, remove the front cover. Confirm that the "CHARGE" LED on the PCB has gone out, and that the voltage between L+1, L+2 and L- is completely discharged.
- 2) Disconnect all wires connected to the control circuit terminal.
- 3) Measure the resistance between the control circuit terminal and ground. The insulation is normal if the resistance is $1M\Omega$ or more.

(3) Inspection of spare parts, etc.

The inspections shown in Table 8-1-b must be performed even for parts which are not powered for a long time, such as spare parts. The characteristics of the large capacity electrolytic capacitor, used in the main circuit, will drop if the capacitor is not energized for a long time. Turn the power ON for approx. five hours once every six months. Also check the operation of the VT240S at this time. If the inverter has not been energized for a long time, do not connect it directly to a commercial power supply. Instead, energize it by using a Slidac, etc., to gradually increase the input voltage and confirm that there is no abnormality.

8-2 Measuring devices

As the voltage and current on the input and output sides include high harmonics, the measured value will differ according to the measuring device. When measuring with a device for commercial frequencies, measure with the following circuits and noted measuring devices.

Use of a digital power meter is recommended for performing a highly accurate measurement.

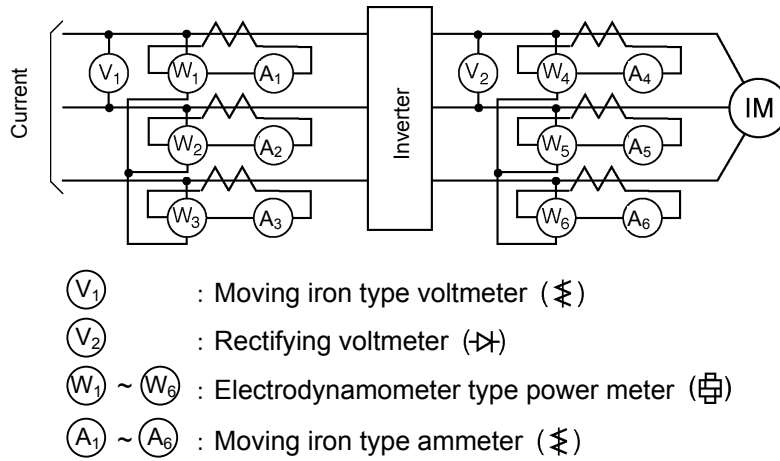

Fig. 8-2 Measurement circuit example

8-3 Protective functions

The VT240S has the protective functions shown in Table 8-3.

Table 8-3 Protective function

Name	Function
Overcurrent trip (OC)	The output is cut off and the inverter stops if the instantaneous value of the output current exceeds the preset value.
Overvoltage trip (OV)	The output is cut off and the inverter stops if the instantaneous value of the DC voltage in the main circuit exceeds the preset value.
Undervoltage trip (UV)	The output is cut off and the inverter stops if the DC voltage drops to approx. 65% or less due to a power failure or voltage drop during operation.
Overcurrent limit	If an overload occurs, the output frequency is automatically adjusted so that the output current is less than the overcurrent limit (125% as a standard) set with B18-0.
Overvoltage limit	If the output frequency is reduced suddenly, the DC voltage will rise in the main circuit due to the regenerative power. The output frequency will be automatically adjusted to prevent the DC voltage in the main circuit from exceeding the preset value.
Overload trip (OL)	The output will be cut off and the inverter will stop if the overload characteristics set with C22-0, 1, 2 and 3 are exceeded. The setting (120% for 1 min. as a standard) can be changed according to the characteristics of the motor. In addition to the above setting, 120% for one minute (standard) or 150% for one minute can be selected with the unit overload mode selection (C30-0).
Overheat (UOH)	An increase in the heat sink temperature is detected with the thermistor and thermostat. When the temperature exceeds the preset value, the output is cut off and the inverter is stopped.
Self-diagnosis (IO, dER, CPU)	The built-in CPU, peripheral circuits and data are tested and monitored for abnormalities.
Grounding trip (GRD)	The output will be cut off and the inverter will stop if a ground fault is detected.
Power module fault (PM)	The operation of the main circuit power module protection function is detected, and the inverter will stop if a fault is detected.
Phase failure (PHL)	A phase failure in the main circuit input/output is detected, the output is shut off, and the operation is stopped.

8-4 Troubleshooting with fault display





The countermeasures for when the inverter stops with a fault displayed are shown in Table 8-4.

Table 8-4 Troubleshooting









Display symbol	Name	Causes and countermeasures											
<p>EMS.</p>	Emergency stop	<ol style="list-style-type: none"> The sequence input EMS has been activated. Check the signal wiring. This fault occurs when C00-4 is set to 2. 											
<p>PM-n</p>	Power module	<ol style="list-style-type: none"> Indicates that the short circuit protection circuit activated. The power module in the main circuit may be broken. Replace if there is any abnormality. A short circuit in the load may have occurred The power module may have malfunctioned due to noise. Improve the installation environment in respect to noise, such as the grounding method or wiring distance. Refer to the following for sub-code n. Sub-code: n <table style="margin-left: 20px;"> <tr> <td>1: Stopped</td> <td>2: In constant speed operation</td> </tr> <tr> <td>3: Accelerating</td> <td>4: Decelerating</td> <td>5: Braking</td> </tr> <tr> <td>6: In ACR</td> <td>7: In excitation</td> <td></td> </tr> <tr> <td colspan="3">9: In automatic tuning.</td> </tr> </table> 	1: Stopped	2: In constant speed operation	3: Accelerating	4: Decelerating	5: Braking	6: In ACR	7: In excitation		9: In automatic tuning.		
1: Stopped	2: In constant speed operation												
3: Accelerating	4: Decelerating	5: Braking											
6: In ACR	7: In excitation												
9: In automatic tuning.													
<p>OC-1</p>	Overcurrent during stop	<ol style="list-style-type: none"> The power module in the main circuit may be broken. Replace if there is any abnormality. The power module may have malfunctioned due to noise. Improve the installation environment in respect to noise, such as the grounding method or wiring distance. 											
<p>OC-2</p>	Overcurrent during constant speed operation	<ol style="list-style-type: none"> A sudden change in the load or short circuit may have occurred. Reduce the load fluctuation. The power voltage may have dropped. The inverter may be running in an unstable range. Set the frequency jump (B05-0 to 5), or adjust the torque stabilizing gain (B18-2). The state may also be improved by changing the carrier frequency (B01-7). (Note 1) The speed loss prevention control may not match the load. Halve the speed loss prevention gain B18-5, and double the time constant B18-6. If the state is improved, finely adjust. The power module may have malfunctioned due to noise. Improve the installation environment in respect to noise, such as the grounding method or wiring distance. 											

(Note 1) Refer to the Appendix Table output Current Derating when changing the carrier frequency. Pay special attention to the state such as motor heating.







8. Maintenance and Inspection

Display symbol	Name	Causes and countermeasures
 OC-3	Overcurrent during acceleration	<ol style="list-style-type: none"> 1. Increase the acceleration time setting (A01-0). 2. The speed or frequency setting may have increased suddenly before the flux was established. Adjust (A01-0). When using V/F control, this state may be avoided by using the external brake control (B46). When using vector control, executing pre-excitation may be effective. However, sufficient timing with the mechanical brakes must be provided if the load could drop, etc. 3. Reduce the torque boost voltage (A02-2). 4. An excess GD^2, short circuit or rapid fluctuation of the load may have occurred. 5. An overcurrent may have been detected when passing through an unstable area. Set the frequency jump (B05-0 to 5), or adjust the torque stabilizing gain (B18-2). The state may also be improved by changing the carrier frequency (B01-7). (Note 1) 6. The speed loss prevention control may not match the load. Halve the speed loss prevention gain B18-5, and double the time constant B18-6. If the state is improved, finely adjust.
 OC-4	Overcurrent during deceleration	<ol style="list-style-type: none"> 1. Increase the deceleration time setting (A01-1). 2. A short circuit or rapid fluctuation of the load may have occurred. 3. An overcurrent may have been detected when passing through an unstable area. Set the frequency jump (B05-0 to 5), or adjust the torque stabilizing gain (B18-2). The state may also be improved by changing the carrier frequency (B01-7). (Note 1) 4. The speed loss prevention control may not match the load. Halve the speed loss prevention gain B18-5, and double the time constant B18-6. If the state is improved, finely adjust.
 OC-5	Overcurrent during braking	<ol style="list-style-type: none"> 1. Reduce the brake voltage setting (A03-0). 2. A short circuit or rapid fluctuation of the load may have occurred.
 OC-6	Overcurrent during ACR	<ol style="list-style-type: none"> 1. A short circuit or rapid fluctuation of the load may have occurred.
 OC-7	Overcurrent during pre-excitation	





8. Maintenance and Inspection

Display symbol	Name	Causes and countermeasures
 OC-9	Overcurrent during automatic tuning	<ol style="list-style-type: none"> 1. Increase the acceleration time setting (A01-0). 2. Increase the deceleration time setting (A01-1). 3. A short circuit or rapid fluctuation of the load may have occurred. 4. Adjust the torque stabilizing gain (B18-2).
 OV-1	Overvoltage during stop	<ol style="list-style-type: none"> 1. The power supply voltage may have risen. Reduce the voltage to within the specified range. 2. A surge voltage may be superimposed on the power supply. Check the power system.
 OV-2	Overvoltage during constant speed operation	<ol style="list-style-type: none"> 1. The power supply voltage may have risen. Reduce the voltage to within the specified range. 2. The rotation speed or load may have fluctuated. 3. The overcurrent limit may have functioned because of a sudden change in the load, etc. Refer to OC-2 and 3 above.
 OV-3	Overvoltage during acceleration	
 OV-4	Overvoltage during deceleration	<ol style="list-style-type: none"> 1. The load GD^2 may be too large. Set the deceleration time (A01-1) according to the load GD^2. 2. The power supply voltage may have risen. Reduce the voltage to within the specified range. The overcurrent limit may have functioned because of a sudden change in the load, etc. Refer to OC-4.
 OV-5	Overvoltage during braking	<ol style="list-style-type: none"> 1. The power supply voltage may have risen. Reduce the voltage to within the specified range.
 OV-6	Overvoltage during ACR	
 OV-7	Overvoltage during pre-excitation	
 OV-9	Overvoltage during automatic tuning	



8. Maintenance and Inspection

Display symbol	Name	Causes and countermeasures											
 UV-n	Undervoltage	<ol style="list-style-type: none"> The power voltage may have dropped, and input phase failure may have occurred, or an instantaneous power failure may have occurred. Check the power supply system and correct if necessary. Refer to the following for sub-code n. Sub-code: n <table style="margin-left: 20px; border: none;"> <tr> <td>1: Stopped</td> <td>2: In constant speed operation</td> </tr> <tr> <td>3: Accelerating</td> <td>4: Decelerating</td> <td>5: Braking</td> </tr> <tr> <td>6: In ACR</td> <td>7: In excitation</td> <td></td> </tr> <tr> <td>9: In automatic tuning.</td> <td></td> <td></td> </tr> </table> 	1: Stopped	2: In constant speed operation	3: Accelerating	4: Decelerating	5: Braking	6: In ACR	7: In excitation		9: In automatic tuning.		
1: Stopped	2: In constant speed operation												
3: Accelerating	4: Decelerating	5: Braking											
6: In ACR	7: In excitation												
9: In automatic tuning.													
 UOH.n	Overheat	<ol style="list-style-type: none"> A trouble may have occurred in the cooling fan. Replace if necessary. The ambient temperature may have risen. Lower the ambient temperature. (50°C or less) The vent or heatsink may be clogged. Clean the dirt and dust accumulated in the vent, etc. The carrier frequency may be set too high. Confirm that the setting is within the range given in Appendix Table 1 (Note 5). Refer to the following for sub-code n. Sub-code: n <table style="margin-left: 20px; border: none;"> <tr> <td>1: Detect with thermistor</td> <td></td> </tr> <tr> <td>2: Detect with thermostat</td> <td></td> </tr> </table> 	1: Detect with thermistor		2: Detect with thermostat								
1: Detect with thermistor													
2: Detect with thermostat													
 SP-1	Overspeed	<ol style="list-style-type: none"> Displays indicating that the motor rotation count exceeded the overspeed setting value (C24-0). Adjust the ASR response (A10-0, 1), and suppress the overshooting. Increase the acceleration time setting (A01-0), or change the speed setting so that it is gradual. 											
 SP-2	Speed detection error	<ol style="list-style-type: none"> Indicates that the motor rotation speed fluctuation ratio exceeded the error level setting value (C24-2). Check the encoder wiring. 											
 SP-3	Speed deviation error	<ol style="list-style-type: none"> Indicates that the difference between the motor rotation speed command value and detected value exceeds the error detection setting value (C24-5, 6). Check the encoder wiring. The speed command may be set incorrectly, or the S-pattern characteristics setting may be too high. Set the speed command and B10-4 properly. 											
 SP-4	Reverse run detection error	<ol style="list-style-type: none"> The motor rotated in the reverse direction of the speed command and exceeded the error detection setting value (C24-7). Check whether the motor ran in reverse because of the load, and check the ASR torque limiter (A10-3, 4) setting values. 											





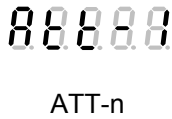

8. Maintenance and Inspection

Display symbol	Name	Causes and countermeasures
 <p>SP-5</p>	Encoder initialization error 1	<ol style="list-style-type: none"> 1. Indicates that an encoder initialization error occurred during PM motor control. <ol style="list-style-type: none"> 1) A, B, Z phase + U, V, W phase signals Indicates that the UVW signal is abnormal. Check the encoder selection (C51-0) and encoder wiring. 2) A, B, Z phase + serial absolute signals Indicates that the serial signal is not being received correctly. Check the encoder selection (C51-0) and encoder wiring. 3) A, B, Z phase + U, V, W phase signals (Reduced wiring) Indicates that the signal is abnormal. Check the encoder selection (C51-0) and encoder wiring. 4) SIN, COS signal Indicates that the signal is abnormal. Check the encoder selection (C51-0) and encoder wiring.
 <p>SP-6</p>	Encoder initialization error 2	<ol style="list-style-type: none"> 1. Indicates that an encoder initialization error occurred during PM motor control. <ol style="list-style-type: none"> 1) A, B, Z phase + serial absolute signals Indicates that the received serial signal is abnormal. Check the encoder wiring. Improve the installation environment in respect to noise. 2) A, B, Z phase + U, V, W phase signals (Reduced wiring) Indicates that the UVW signal is abnormal. Check the encoder selection (C51-0), time setting (C51-7 to 9) and encoder wiring. 3) SIN, COS signal Indicates that the SIN or COS signal is disconnected. Check the encoder wiring.
 <p>FUSE</p>	Fuse blown	<ol style="list-style-type: none"> 1. Indicates that the main circuit fuse in the use is disconnected. (Limited to capacities having a fuse warning contact.) Check that the main circuit input/output wiring is correct. Check whether any foreign debris has entered the unit, or whether there is any short-circuit or ground fault. If the fuse is blown, it must be replaced.
 <p>BPFLT</p>	Parallel unit signal cutoff	<ol style="list-style-type: none"> 1. Indicates that the connection signal was disconnected when using a parallel machine. Check the wiring and connector.







8. Maintenance and Inspection

Display symbol	Name	Causes and countermeasures
 ATT-n	Automatic tuning abnormal completion n: Step No.	<ol style="list-style-type: none"> 1. n = 1 The motor may not be connected correctly. Check the connection. The B00 and B01 parameters may not be set correctly. Check the parameter settings. 2. n = 2 The B00 and B01 parameters may not be set correctly. Check the parameter settings. 3. n = 3 The load and machine may not be separated. Separate the load and machine. Increase the acceleration time (A01-0). Increase the deceleration time (A01-1). If the motor vibrates, increase the torque stabilizing gain (B18-2). 4. n = 4 The load and machine may not be separated. Separate the load and machine. If the motor vibrates, increase the torque stabilizing gain (B18-2). 5. n = 5 If the motor does not stop. Increase the acceleration/deceleration time (A01-0, A01-1). If the motor is stopped. The B00 and B01 parameters may not be set correctly. Check the parameter settings. 6. n = 6 The B00 and B01 parameters may not be set correctly. Check the parameter settings. 7. n = 8 The voltage did not stabilize for one second or longer during pulse measurement. Adjust the pulse voltage for magnetic pole estimation (B39-1) and pulse width for magnetic pole estimation (B39-2). 8. n = 9 Automatic tuning did not end correctly even after retrying three times. Adjust the pulse voltage for magnetic pole estimation (B39-1) and pulse width for magnetic pole estimation (B39-2).
 OL-1	Equipment load	<ol style="list-style-type: none"> 1. VT240S may have overloaded. Reduce the load or increase the inverter capacity. 2. If this occurs at a low speed, avoid continuous operation at a low speed, or decrease boost (A02-2) and brake voltage (A03-0).
 OL-2	DBR overload	<ol style="list-style-type: none"> 1. The regenerative power may be excessive. Increase the deceleration time, and reduce the regenerative power. 2. C22-4: DBR overload may not be set correctly. Set a value appropriate for DBR and the unit.



8. Maintenance and Inspection

Display symbol	Name	Causes and countermeasures
 OL-3	Motor overload	<ol style="list-style-type: none"> The motor may have overloaded. Reduce the load or increase the motor and inverter capacity. If this occurs at a low speed, avoid continuous operation at a low speed, or decrease boost (A02-2) and brake voltage (A03-0). When using vector control, the problem may be improved by lowering the no-load voltage (B01-9).
 GRD.n	Grounding	<ol style="list-style-type: none"> A ground fault may have occurred in the power cable or motor. Restore the grounded point. The power module may have malfunctioned due to noise. Improve the installation environment in respect to noise, such as the grounding method or wiring distance. Refer to the following for sub-code n. Sub-code: n 1: Stopped 2: In constant speed operation 3: Accelerating 4: Decelerating 5: Braking 6: In ACR 7: In excitation 9: In automatic tuning.
 IO-1	I/O error (gate turn-off circuit error)	<ol style="list-style-type: none"> The VT240S may be malfunctioning due to external noise, etc. Look for the noise source and remove the cause. The control circuit may be faulty. The OC, OV, GRD or PM fault may have occurred immediately after the run command was input (within 6ms). Check the faulty history, and investigate the cause.
 IO-2	I/O error (A/D converter error)	<ol style="list-style-type: none"> The VT240S may be malfunctioning due to external noise, etc. Look for the noise source and remove the cause. The control circuit may be faulty.
 IO-3	I/O error (current detection error)	<ol style="list-style-type: none"> The current detector connectors may be connected improperly. Properly connect these. The current detection may be faulty.
 IO-4	I/O error (retry time-out)	<ol style="list-style-type: none"> Retry has failed. There are no countermeasures for this code, so reset the VT240S.
 IO-B	PID error	<ol style="list-style-type: none"> The PID settings or detected input may be incorrect. Check the settings or detection value.

8. Maintenance and Inspection

Display symbol	Name	Causes and countermeasures
 IO-C	External brake IDET error	1. The output current did not reached the current detection value (C15-1) when releasing the external brake. Check that the settings are correct, or that the motor wiring connections are correct.
 IO-D	External brake RUN error	1. RUN did not turn OFF after engaging the external brake. Check that the settings are correct, or that the RUN command is OFF within B46-4.
 IO-E	External brake answer error	1. The brake command and answer signal from the brake do not match. Check the answer signal from the brake.
 CPU-n	CPU error	1. The unit may be malfunctioning due to external noise, etc. Look for the noise source and remove the cause. 2. The control circuit may be faulty. 3. For all sub-codes other than 8, turn the power off and on once. 4. Refer to the following for sub-code n. Sub-code: n 1: Watch dog error (CPU operation is delayed. This is detected during normal operation.) 2: CPU operation error 3: CPU internal RAM error 4: External RAM error 6: EEPROM check sum error 7: EEPROM read error 8: EEPROM write error (This is only displayed. The gate is not cut off, and FLT is not output.) A: Stack overflow B: Simple PLC overload
 DER	E ² PROM data error	1. The parameter setting value is incorrect. Correct the parameter setting value with the following procedure. (1) Select D20-2 with the monitor mode, and press the set key. The parameter for which an error occurred will display. (2) Set the correct parameter in this state. (3) Press the ▲ and ▼ keys to sequentially display the erroneous parameters.
 EP.ERR.	Verify check data error	1. An error may have occurred when using verify check in the parameter copy function using the operation panel. Execute the parameter copy function again.

8. Maintenance and Inspection

Display symbol	Name	Causes and countermeasures
 PHL1	Input phase failure	<ol style="list-style-type: none"> 1. There may be a phase failure in the AC input power supply. Investigate the AC input power supply, and eliminate the phase failure. 2. The AC input wiring may be disconnected. Check the tightening, etc., of the AC input wire. 3. The load pulsation may be too high, or the motor control may be hunting. Suppress the load pulsation, or lower the ASR response. 4. When using an electrical circuit configuration which includes the external circuit, it may be resonating. Contact Meidensha.
 PHL2	Output phase failure	<ol style="list-style-type: none"> 1. The motor's primary coil may not be correct. Check the motor. 2. The motor wiring may be disconnected. Check the wire tightening state, etc.

8-5 Troubleshooting with no fault display

The causes and countermeasures for errors with no fault display are shown in Table 8-5.

Table 8-5 Troubleshooting

Phenomenon	Causes and countermeasures
Motor does not run	<ol style="list-style-type: none"> 1. The input/output cable may be incorrectly wired, the motor may be incorrectly connected, a phase failure may have occurred or the power voltage may have dropped. Check and correct the wiring. Confirm that READY is completed with D04-4, that the run command related bits (RDY1, RDY2, MC, RUN) are lit, and that the fault bit (FLT) is not lit. 2. The motor may be locked or the load excessively heavy. Reduce the load. If the starting torque is insufficient during V/f control, adjust the torque boost (A02). A large starting torque can be attained by selecting automatic torque boost (A02-1;2), and finely adjusting the slip compensation gain (A002-5) and maximum torque boost gain (A02-6) attained with automatic tuning. 3. The reverse run interlock function (C09-3) may be set or the other parameters may be incorrect. Check the RUN, REV and EMS signals with D04-0. If the signal is input, cancel it once before starting. 4. The voltage may not be output to the VT240S output terminal. Measure the output voltage, and confirm that the three phases are balanced. 5. The local/remote setting may be incorrect. Set according to the required mode. 6. The frequency (speed) command may not be input. When using V/F control, refer to D01-0 (D01-4 for vector control), and check the currently set value. Refer to section 5-9 for details. 7. When using vector control, the encoder signal may not be input correctly. Check the encoder signal. Check that the D00-2 rotation detection is correct when the motor is manually turned forward and reverse. If abnormal, check the wiring, etc. Change the encoder phase order (C50-2, C51-3).
Motor runs in opposite direction	<ol style="list-style-type: none"> 1. The output terminals U, V, and W sequence may be incorrect. Interchange the phase sequence. When using vector control, also change the encoder phase order (C50-2, C51-3) according to the changes in the main circuit phase order. 2. The sequence input wires for forward/reverse run may not be connected to the specified terminals. Connect the wires as follows: Forward run: Short-circuit terminals PS11 - RY0 (When input terminal function setting is C03-0=1 (default value)) Reverse run: Short-circuit terminals PS14 - RY0 (When input terminal function setting is C03-2=4 (default value))
Motor runs but the speed does not vary	<ol style="list-style-type: none"> 1. The load may be too heavy. Reduce the load. 2. The frequency setting signal level may be too low. Check the signal level and circuit. When using V/F control, refer to D01-0 (D01-4 for vector control), and check the currently set value. Refer to section 5-9 for details.

8. Maintenance and Inspection

Phenomenon	Causes and countermeasures
Motor acceleration/ deceleration is not smooth	<ol style="list-style-type: none"> 1. The motor acceleration/deceleration time setting (A01-0, 1) may be too low. Increase the acceleration/deceleration time. 2. Reduce the manual torque boost voltage (A02-2). If automatic torque boost (A02-1) is selected, adjust A02-5 and A02-6. 3. The speed or frequency setting may have increased suddenly before the flux was established. Adjust (A01-0). When using V/F control, this state may be avoided by using the external brake control (B46). When using vector control, executing pre-excitation may be effective. However, sufficient timing with the mechanical brakes must be provided if the load could drop, etc. 4. An unstable area may have been passed through. Set the frequency jump (B05-0 to 5), or adjust the torque stabilizing gain (B18-2). 5. When using IM speed sensor-less vector control, carry out the adjustment in item 3-5-2.
Motor speed varies during constant speed operation	<ol style="list-style-type: none"> 1. The load may be fluctuating excessively or the load is too heavy. Reduce the load or fluctuation. 2. When using vector control, adjust ASR response (A10-0, 1). To increase the speed control response in respect to sudden load fluctuations (impact drop load, etc.), adjust B30-0, 1. Hunting could occur if this is set too high. 3. The speed detection may be affected by noise. Improve the installation environment in respect to noise, such as the grounding method or wiring distance. 4. If the speed fluctuates during IM speed sensor-less vector control, adjust the speed estimation related parameters (B31-0, 1, 2). 5. The inverter-motor ratings may not match the load. Select an inverter-motor set that matches the load.
Motor speed is too high or low	<ol style="list-style-type: none"> 1. The number of poles or voltage may be incorrect. Check the motor specifications. 2. The maximum frequency (speed) or base frequency [B00-4, 5 (B01-4, 5)] may be incorrect. 3. The motor terminal voltage may be low. Use a thicker output cable.
Operation panel display cannot be changed, or the display is frozen. Cannot display target operation mode.	<ol style="list-style-type: none"> 1. The operation panel connector may be disconnected, or the cable may be broken. Check the connector and wiring. 2. Communication with the operation panel may be disconnected because of noise. Turn the VT240S power OFF once, wait for the operation panel display to go out, and then turn the power ON again.
Cannot pick up	<ol style="list-style-type: none"> 1. The parameter settings or external setting may be incorrect. PICK (C04-D), automatic start (C08-0) and the control signals from the external source (run command, pick-up command, emergency stop input, etc.) may not be input correctly. Correctly set the related parameters. 2. The pick-up related parameters may not be adjusted properly. Adjust the pick-up related parameters (C21). 3. The overcurrent limit related parameters may not be adjusted properly. If an overcurrent fault (OC) or overvoltage fault (OV) occurs, adjust the overcurrent speed loss prevention gain and time constant (B18-5, 6). Try setting B18-5 to half of the preset value (0.50) and B18-6 to double the value (200). If an effect is observed, finely adjust the settings. Note that the effect may differ according to the motor and load.

Chapter 9 Compatible Standards

9-1 UL/cUL Standards

The VT240S complies with UL508C and CSA C22.2 No.14.

Observe the following matters when using the inverter as a UL/cUL Standard compatible product.

- 1) Use the inverter in an installation environment which does not exceed the set maximum ambient temperature.
- 2) For the main circuit connected to the inverter, use a "75°C CU" "voltage rating 600V or higher" copper wire.
- 3) Use the wire sizes given in Table 9-1-a and Table 9-1-b for the main circuit wiring. Use a UL/CSA Certified round crimp terminal which matches the wire diameter for the terminal connection. Crimp the crimp terminal with a crimping tool recommended by the maker.
- 4) When wiring the circuit, tighten with the torque given in Table 9-1-a and Table 9-1-b.
- 5) The branch wire must be protected following the National Electrical Codes and local standards.
- 6) Always provide a UL Certified fuse or UL Certified non-fuse breaker (MCCB) protection circuit shown in Table 9-1-c on the input side of the inverter. Use a fuse for the 011L/015H and smaller capacities.
- 7) Use a power that complies with the following conditions for the inverter's input power.

0P7L to 055L 240VAC or less	Short-circuit current 10,000A or less
075L, 090L 240VAC or less	Short-circuit current 42,000A or less
0P7H to 055H 480VAC or less	Short-circuit current 10,000A or less
075H to 475H 480VAC or less	Short-circuit current 42,000A or less
- 8) Install the inverter as "open type equipment".
- 9) The installation environment must satisfy "pollution degree 2".
- 10) The inverter has a motor overload protection function. Refer to Chapter 6, and set parameters C22-0 to 3 correctly.

Motor overload (OL-3)

Use the C22-3 setting to set the trip breakdown reference current for one minute in the case of a motor rated current (B00-6, B01-6) of 100%. When C22-3 is set to 120% for example, if C22-0 is 100%, and 120% of the motor rated current is output, a breakdown stop will occur due to a motor overload after one minute.

As shown in Fig.9-1-a, the counterclockwise limit characteristics change by setting C22-0. The diagram on the right is an example with C22-0 set to 100% and 50% when C22-3=150%.

For the self-cooling motor, when operating at low speed, set C22-1 and C22-2 to meet the motor characteristics. These characteristics are as shown in Fig.9-1-b.

The motor overload can be monitored at D02-6. Furthermore, select setting value 8 at C13-0, 1 to enable analog output.

- 11) Use the control terminals RA/RC, FA/FB/FC at 30VAC/DC or less.

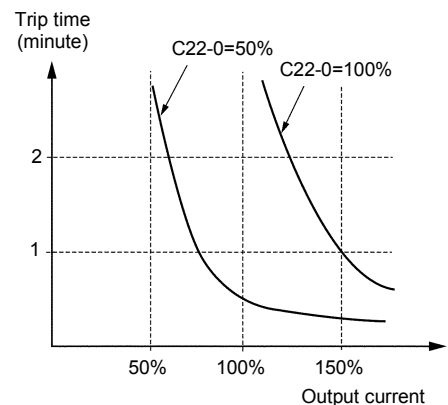

Fig.9-1-a Overload characteristics

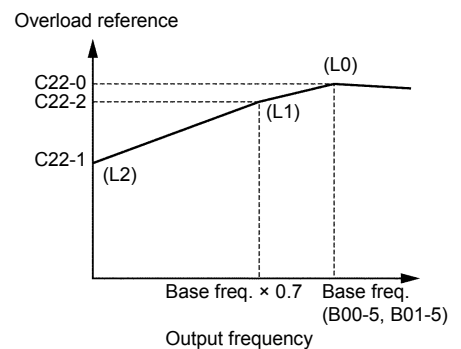

Fig.9-1-b Reduction of the Overload reference by frequency.

9. Compatible Standards

Table 9-1-a Terminals, Applicable Wire Sizes and Tightening Torque (For Normal-duty)

Inverter type VT240S-□	Terminal screw size	Tightening torque		L1, L2, L3, U, V, W			⊕ Ground		
		N·m	lb-in	Terminal connector Part No.	AWG	mm ²	Terminal connector Part No.	AWG	mm ²
0P7L	M4	1.2	10.6	R2-4	14	2.1	R2-4	14	2.1
1P5L	M4	1.2	10.6	R2-4	14	2.1	R2-4	14	2.1
2P2L	M4	1.2	10.6	R2-4	14	2.1	R2-4	14	2.1
4P0L	M4	2.0	17.7	R5.5-4	10	5.3	R5.5-4	12	3.3
5P5L	M4	2.0	17.7	8-4	8	8.4	R5.5-4	10	5.3
7P5L	M5	2.0	17.7	R8-5	8	8.4	R5.5-5	10	5.3
011L	M5	4.5	39.8	R14-5	6	13.3	R5.5-5	10	5.3
015L	M6	9.0	79.6	38-6	3	26.7	R8-6	8	8.4
018L	M8	9.0	79.6	R38-8	2	33.6	R8-8	8	8.4
022L	M8	9.0	79.6	R60-8	1	42.4	R14-8	6	13.3
030L	M8	9.0	79.6	R60-8x2p	1/0x2p	53.5x2p	R14-8	6	13.3
037L	M10	18.0	159.3	R60-10x2p	1/0x2p	53.5x2p	R14-10	6	13.3
045L	M10	28.9	255.7	R60-10x2p	1/0x2p	53.5x2p	R22-10	4	21.2
055L	M10	28.9	255.7	R60-10x2p	1/0x2p	53.5x2p	R22-10	4	21.2
075L									
090L									
0P7H	M4	1.2	10.6	R2-4	14	2.1	R2-4	14	2.1
1P5H	M4	1.2	10.6	R2-4	14	2.1	R2-4	14	2.1
2P2H	M4	1.2	10.6	R2-4	14	2.1	R2-4	14	2.1
4P0H	M4	1.2	10.6	R2-4	14	2.1	R2-4	14	2.1
5P5H	M4	1.2	10.6	R5.5-4	12	3.3	R5.5-4	12	3.3
7P5H	M4	2.0	17.7	R5.5-4	10	5.3	R5.5-4	10	5.3
011H	M4	2.0	17.7	8-4	8	8.4	R5.5-4	10	5.3
015H	M5	2.0	17.7	R8-5	8	8.4	R5.5-5	10	5.3
018H	M5	2.0	17.7	R14-5	6	13.3	R5.5-5	10	5.3
022H	M5	4.5	39.8	R14-5	6	13.3	R5.5-5	10	5.3
030H	M6	9.0	79.6	R22-6	4	21.2	R8-6	8	8.4
037H	M8	9.0	79.6	R38-8	2	33.6	R8-8	8	8.4
045H	M8	9.0	79.6	R60-8	1	42.4	R14-8	6	13.3
055H	M8	18.0	159.3	R60-8	1/0	53.5	R14-8	6	13.3
075H									
090H									
110H									
132H									
160H									
200H									
250H									
315H									
400H									
475H									

9. Compatible Standards

Table 9-1-b Terminals, Applicable Wire Sizes and Tightening Torque (For Heavy-duty)

Inverter type VT240S-□	Terminal screw size	Tightening torque		L1, L2, L3, U, V, W			⊕ Ground		
		N·m	lb-in	Terminal connector Part No.	AWG	mm ²	Terminal connector Part No.	AWG	mm ²
0P7L	M4	1.2	10.6	R2-4	14	2.1	R2-4	14	2.1
1P5L	M4	1.2	10.6	R2-4	14	2.1	R2-4	14	2.1
2P2L	M4	1.2	10.6	R2-4	14	2.1	R2-4	14	2.1
4P0L	M4	2.0	17.7	R2-4	14	2.1	R2-4	14	2.1
5P5L	M4	2.0	17.7	R5.5-4	10	5.3	R5.5-4	12	3.3
7P5L	M5	2.0	17.7	R8-5	8	8.4	R5.5-5	10	5.3
011L	M5	4.5	39.8	R14-5	6	13.3	R5.5-5	10	5.3
015L	M6	9.0	79.6	R22-6	4	21.2	R5.5-6	10	5.3
018L	M8	9.0	79.6	R38-8	3	26.7	R8-8	8	8.4
022L	M8	9.0	79.6	R60-8	1	42.4	R8-8	8	8.4
030L	M8	9.0	79.6	R60-8	1/0	53.5	R14-8	6	13.3
037L	M10	18.0	159.3	R60-10x2p	1/0x2p	53.5x2p	R14-10	6	13.3
045L	M10	28.9	255.7	R60-10x2p	1/0x2p	53.5x2p	R14-10	6	13.3
055L	M10	28.9	255.7	R60-10x2p	1/0x2p	53.5x2p	R22-10	4	21.2
075L									
090L									
0P7H	M4	1.2	10.6	R2-4	14	2.1	R2-4	14	2.1
1P5H	M4	1.2	10.6	R2-4	14	2.1	R2-4	14	2.1
2P2H	M4	1.2	10.6	R2-4	14	2.1	R2-4	14	2.1
4P0H	M4	1.2	10.6	R2-4	14	2.1	R2-4	14	2.1
5P5H	M4	1.2	10.6	R2-4	14	2.1	R2-4	14	2.1
7P5H	M4	2.0	17.7	R5.5-4	12	3.3	R5.5-4	12	3.3
011H	M4	2.0	17.7	R5.5-4	10	5.3	R5.5-4	10	5.3
015H	M5	2.0	17.7	R5.5-5	10	5.3	R5.5-5	10	5.3
018H	M5	2.0	17.7	R8-5	8	8.4	R5.5-5	10	5.3
022H	M5	4.5	39.8	R14-5	6	13.3	R5.5-5	10	5.3
030H	M6	9.0	79.6	R22-6	4	21.2	R5.5-6	10	5.3
037H	M8	9.0	79.6	R38-8	3	26.7	R8-8	8	8.4
045H	M8	9.0	79.6	R38-8	2	33.6	R8-8	8	8.4
055H	M8	18.0	159.3	R60-8	1	42.4	R14-8	6	13.3
075H									
090H									
110H									
132H									
160H									
200H									
250H									
315H									
400H									
475H									

(Note1) "x2p" refers to two parallel connections.

(Note2) Terminal and crimping tools maker : JST Mfg. Co., Ltd.

Crimping tools :

Ratchet Hand Tool, Model No. YHT-2210 (up to 10AWG)

Pneumatic Hand Tool, Model No. YA-5 (from 8AWG up to 1/0AWG)

9. Compatible Standards

Table 9-1-c Input protection fuse, MCCB rated current

Inverter type VT240S-□	Applicable protection circuit	Fuse/MCCB rated current (A)	
		Normal-duty	Heavy-duty
0P7L	UL Certified fuse Voltage rating 300V Class T Fast Acting or Voltage rating 600V Class J Fast Acting	15	15
1P5L		15	15
2P2L		15	15
4P0L		20	15
5P5L		30	20
7P5L		40	30
011L		60	40
015L	UL Certified fuse Voltage rating 300V Class T Fast Acting or Voltage rating 600V Class J Fast Acting or UL Certified no-fuse breaker (MCCB)	80	60
018L		100	80
022L		125	100
030L		150	125
037L		200	150
045L		225	200
055L		300	225
075L		400	300
090L		500	400
0P7H	UL Certified fuse Voltage rating 600V Class T Fast Acting or Voltage rating 600V Class J Fast Acting	15	15
1P5H		15	15
2P2H		15	15
4P0H		15	15
5P5H		20	15
7P5H		25	20
011H		30	25
015H	40	30	
018H	UL Certified fuse Voltage rating 600V Class T Fast Acting or Voltage rating 600V Class J Fast Acting or UL Certified no-fuse breaker (MCCB)	50	40
022H		60	50
030H		80	60
037H		100	80
045H		125	100
055H		150	125
075H		200	150
090H		225	200
110H		300	225
132H		350	300
160H		400	350
200H		500	400
250H		600	500
315H		800	600
400H		1000	800
475H		1200	1000

9-2 CE Marking

The VT240S-0P7L to 090L and 0P7H to 475H capacities comply with the EMC Directives and Low Voltage Directives. Observe the following matters when using the inverter as an EMC Directive compliant product.

9-2-1 EMC Instruction of preface

This Instruction details how to meet the EMC directives (89/336/EEC) with VT240S. It is important to understand and before installation and operation of drive. The VT240S designed to meet the EMC directives and are suitable for use in the Industrial, Residential, Commercial and Light Industrial Environments. These drives have been tested with the power cables and control leads connected as shown in Fig. 9-2-a. If these drives are connected with fewer control leads than these examples, it may be possible to reduce installation costs by using ordinary cables rather than screened cables which are recommend in this manual. It is strongly advised however that a compliance test should be performed under the actual operating conditions to certify that the system complies with the relevant EMC requirements. If the drives are used with any of the optional cards, you must provide suitable extra measures and must certify through a test that the product, system or installation complies with the relevant EMC requirements.

This instruction also details how to use filters for installation: the installation where the drives are installed as stand-alone equipment without being fitted into any enclosure, and the installation where the drives are installed inside a metal enclosure.

 WARNING
<ol style="list-style-type: none"> 1. This manual represents Meidensha's recommendations based on its understanding of the EMC regulations only and Meidensha cannot accept responsibility for any legal problems arising from or in connection with the use of its products. 2. Meidensha have made every effort to ensure that their products comply with the directives laid out in the certificate of conformity which is supplied with each drive. In the case of EMC, the testing has been carried out using the filters which are recommended for each product. As VT240S in size up to 30kW are designed to be built into metal cabinets, they are considered to be components. Therefore, the final responsibility for compliance rests with the system builder.

9-2-2 Installation environment

Table 9-2-a shows the EMC standard conformity table of VT240S. VT240S supports EN61800-3 Second Environment Category C3 fundamentally. 0P7L~2P2L and 0P7H~5P5H can respond to EN61800-3 First Environment Category C2 by installing a ferrite core in a built-in noise filter. Please refer to Table 9-2-c~f about the form of a ferrite core. Installing VT240S in size 030H and smaller, 018L and smaller within a metal structure control cabinet and 037H ~ 055H, 022L ~ 045L with stand-alone is recommended to use in Residential, Commercial, and Light Industrial Environment, ensure that the drive is not installed adjacent to devices or equipment, for instance, measuring devices that are not CE marked.

For VT240S in size 075H and larger and 055L and larger that are not designed for use in the Residential, Commercial and Light Industrial Environments, ensure that no device or equipment is installed adjacent to the drive that is intended for the Residential, Commercial and Light Industrial Environments only, as interference with such equipment may occur.

Table 9-2-a EMC standard conformity table of VT240S

Conformity standard	First environment (EN61800-3:Category C2)	Second environment (EN61800-3:Category C3)
The view of VT240S	from 0P7L to 2P2L from 0P7H to 5P5H	from 4P0L to 090L from 7P5H to 475H

9-2-3 Input filters and their connections

 WARNING
<ol style="list-style-type: none"> 1. Electrical shock hazards. The input filter terminals must be fully covered with appropriate insulation material to avoid electrical shocks. 2. Electrical shock hazards. The input filters must be fully earthed. Otherwise, there may be a risk of electrical shocks and the effectiveness of filters will be impaired.

In most cases, the input filter should be installed as closely to the drive as possible to ensure its effectiveness. The following table shows the maximum distance between the filter and the drive. This may be changed, if, for instance, a complete system is filtered in its entirety. In this case, the whole system would require testing to ensure EMC compliance.

Table 9-2-b Max. distance between drive and filter

Sizes	Max. distance
0P7L~5P5L, 0P7H~030H	0.3 meter
7P5L ~090L , 037H~475H	0.5 meter

Ensure that the input filter is securely and effectively earthed. If the drive is installed on a metal plate, install the filter on the same plate and then earth the plate. This is effective to reduce EMI.

9-2-4 Choosing and installing power cables

9-2-4-a Choosing power cables

The input cables to the drive via the filter must be selected from those specified in the drive's manual. The output cables from the drive must be screened or armoured cables (see Fig. 9-2-a) and should be selected from Table 9-1-a or Table 9-1-b.

9-2-4-b Installing power cables

The power cables comprises three sections: one on the primary side of the filter, one between the filter and the drive and one on the output of the drive. Ensure that these are not installed in parallel to each other and that these are laid down apart from each other by at least 0.5m. Please also ensure that the screen of the output cable is earthed at both ends with one end connected to the drive's earth terminal and the other end to that of the motor. Please arrange the termination at the drive's end inside the drive enclosure, and if this is not possible and the cable is terminated outside the drive enclosure, terminate the cables as closely to the drive's conduit hole as possible, i.e., within 0.1 m from it.

If the screened output cables are over 5 meters, this may cause a problem arising from a floating capacitance, such as undesirable surge voltage increase at the motor terminals, electrical noises from the cables when they discharge capacitance, or increase in leakage currents. In this case, Meidensha recommend the use of output chokes. Please contact your supplier for more information.

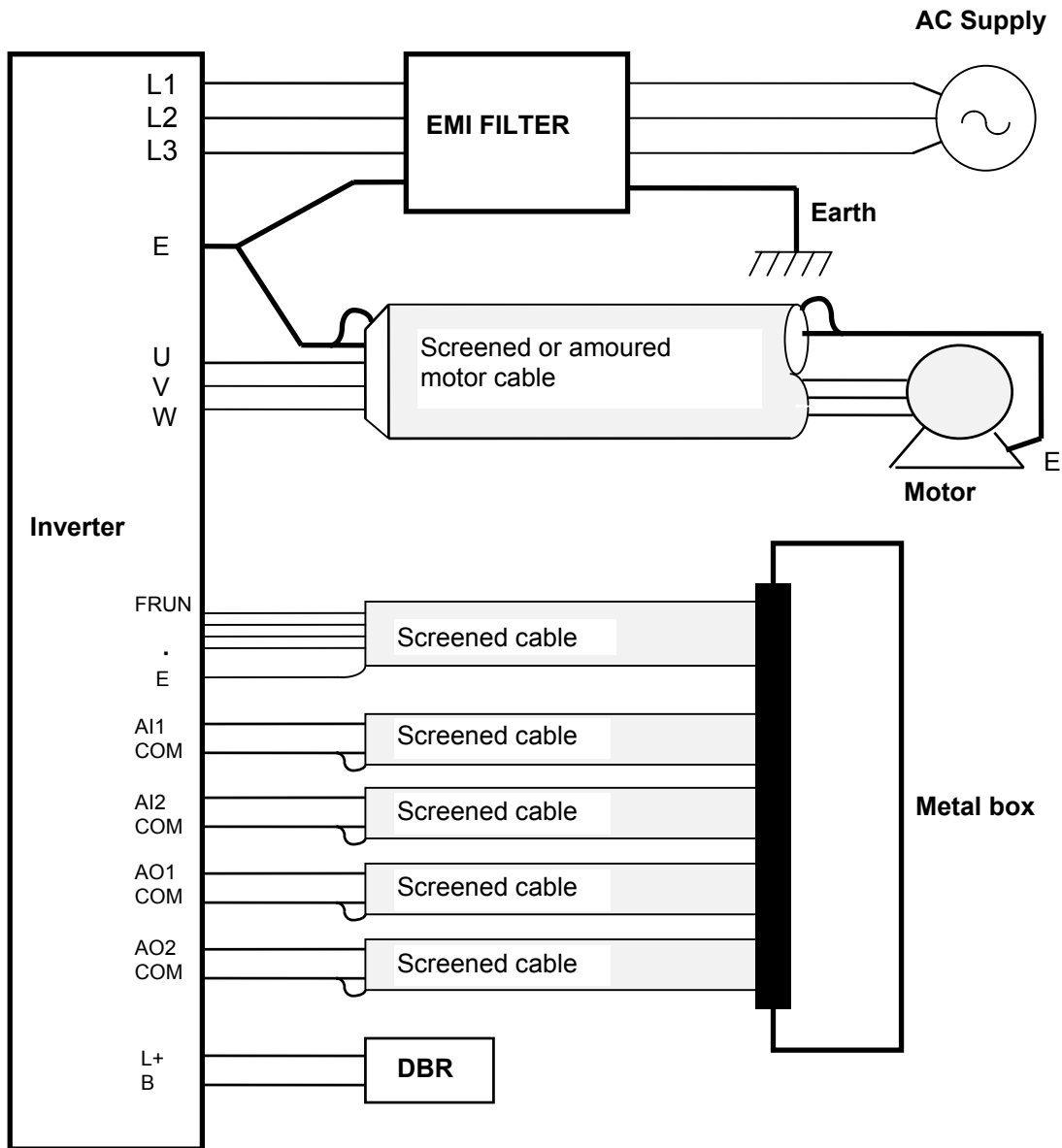

Fig.9-2-a Installation (Stand-alone)

9-2-5 Choosing and connecting control leads

Control leads should be selected in accordance with the instructions in the drive's manual and should be screened if they are used for a speed setting circuitry, analogue signal circuitry for metering, or relay signal circuitry. The screen should be connected to the drive's earth or COM terminal only (refer to Fig.9-2-a) The control leads should be wired away from the power cables. If the control leads must run across the power cables, cross them at the right angle, and if they are laid down alongside each other, ensure to separate them by at least 0.5 m. When the section which runs along the power cables exceeds 10 m, separate them further more. The control leads should not share the same conduit hole of the drive with the power cables. Separate analogue control leads from relay control leads.

To reduce emission and to increase immunity, ensure that no control leads are connected that are not used. Also, ensure that control leads are wired in such manner that they are as short as possible.

The relay signal controller and analogue speed setting controller, analog signal meters should be put in a metal box together.

9-2-6 Earthing method

Earth the drive, motor and filter in such manner that the earthing cables are as short as possible. Select and install earthing cables in accordance with local requirements. It is recommendable to use low impedance earthing cables, i.e. those that can carry as much current as possible. If the motor does not share the same earth post with the drive and filter, do not connect the screen and earth lead of the drive's output cable to the motor.

9-2-7 EMI and EMS

The EMC directives set out immunity requirements for the electrical drive (ability to work properly without being affected by external electromagnetic disturbance), in addition to the previously enforced emission requirements (electromagnetic disturbance generated by the electrical drive).

In addition to the radiated noise directly generated from the drive and its connected cables, the emission requirement includes the conducted noise which is conducted outside the drive through the input cables.

Immunity is the ability of a drive to operate properly without being affected by an external disturbance.

The EMC compliance is only achieved when the drive's immunity level exceeds its emission level under its operating environment.

In addition to the immunity against a radiated and conducted disturbance, the EMC directives also requires of the drive the immunity against static electricity discharges and fast transients.

A human body can easily be charged with static electricity by merely walking on carpet and with a mere touch on the drive, this static electricity will be discharged through it. A discharging spark can be at such a magnitude that it can damage the drive.

A drive which is installed near cables connected to a switchable inductive load can often operate incorrectly due to a fast transient induced on its control leads at a switching of the inductive load.

These are just a few examples of disturbance to which the drive is exposed, and the drive is now required to operate correctly without being affected by such disturbance.

9-2-8 Considerations to measuring devices

All the cables and leads connected to the drive or filter should be regarded as active sources of electrical noise. For inspection or service, use measuring devices or equipment that are CE marked. If they require an external power supply, use one which is separate or well insulated from that of the drive system.

Even for a system that comprises CE marked equipment and devices only, an EMC compliance test may be required if the whole system is exported from one country to another. Ask the local government for details.

9-2-9 Installation into a metal cabinet

To clear the levels of the Residential, Commercial, Light Industrial Environments and the Industrial Environment for the drives up to 30kW, the following method of installation is required.

- (1) As shown in Fig. 9-2-b, an inverter unit is installed in the board of a metal cabinet. The attached shield grounded metal corresponding to EMC is attached in an inverter with a screw.
- (2) Power cable and a motor cable should use a shield line, and should shorten it as much as possible. A shield is firmly clamped to the shield grounded metal corresponding to EMC, and is grounded to it. Moreover, please connect a shield with the grounding terminal of a motor electrically.
- (3) Wiring of the control terminal of an inverter should use a shield line. A shield is firmly clamped to the shield grounded metal corresponding to EMC, and is grounded to it.
- (4) A radiation noise can be further controlled by inserting a ferrite core in the power line, motor line, and control line of an inverter. (Fig. 9-2-b, Fig. 9-2-c reference)

If can respond to the category C3 of EN61800-3 by installing a unit in a metal cabinet.
It can respond to the category C2 of EN61800-3 by connecting a ferrite core to a power cable at three pieces it (It installs in two insides of a unit.), and connecting it to a motor cable at one one-piece control cable. Refer to Tables 9-2-c,d,e and f for the details of a ferrite core.

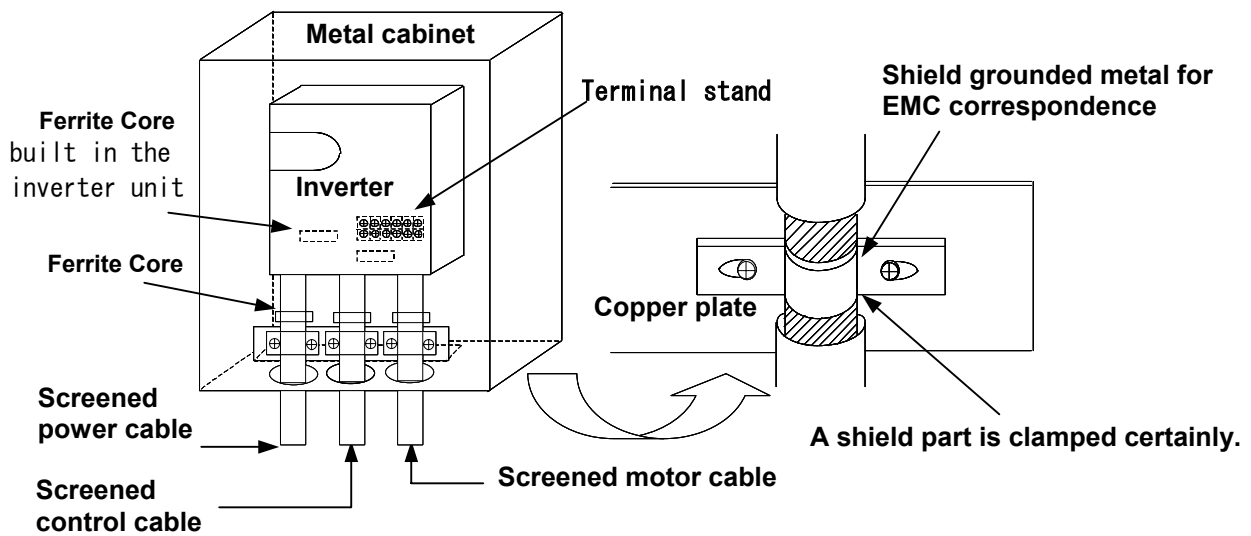

Fig. 9-2-b

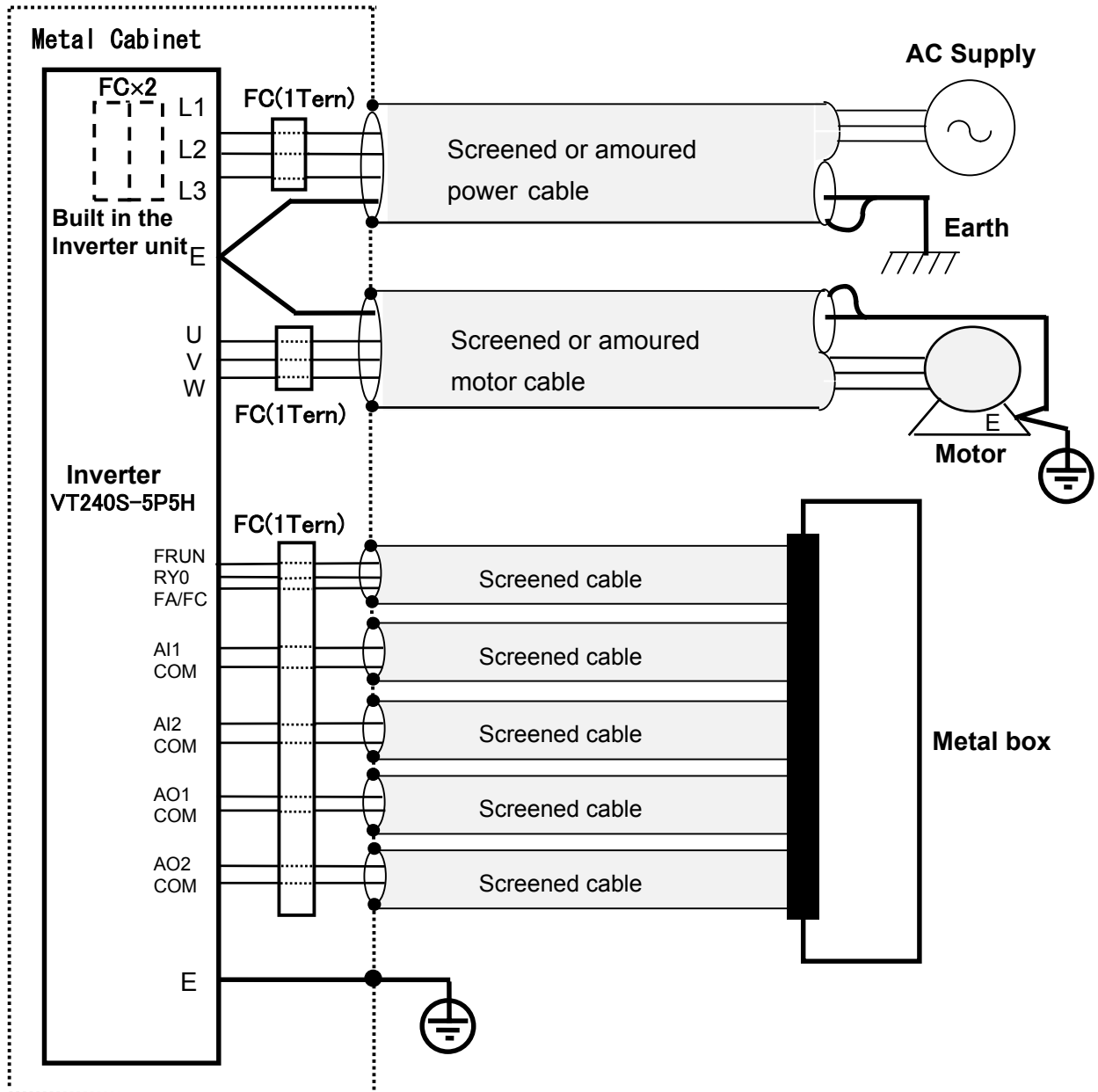

Fig. 9-2-c

Ferrite Core	Type	Manufacturer
FC	ZCAT3035-1330	TDK

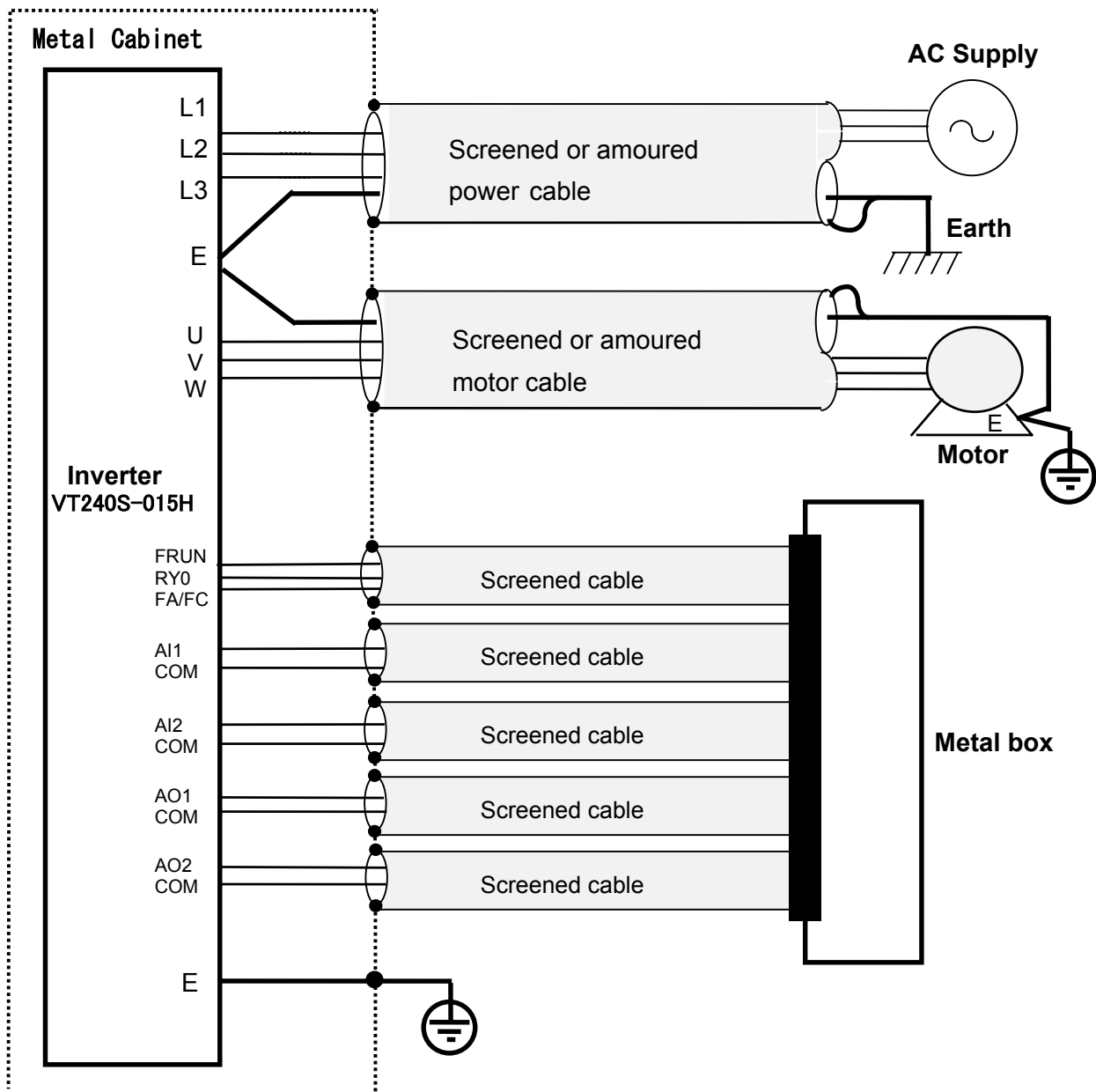

Fig. 9-2-d

9-2-10 Selecting and fitting of filters and ferrite cores for the installation

9-2-10-a Selecting the filter

The following method of installation is required for compliance with the EMC Directives.

- (1) The cables between the filter and the drive should be as short as possible.
- (2) For the correct filters, see Tables 9-2-c,d,e and f and for correctly fitting them.
- (3) Filters with current rating exceeding 100A are available for separate-mounting only.

9-2-10-b Required input filters to achieve EMC compliance with VT240S

The following filters have been certified for EMC compliance for use with VT240S.

Table 9-2-c Input filters for VT240S drives up to 045L

Series	Size	Output current (A) ^{*1}	Filter type	Ferrite core type ^{*2}
200V Series	0P7L	5.0	Built-in	ZCAT3035-1330x5(1)
	1P5L	8.0		
	2P2L	11.0		ZCAT3035-1330x5(1)
	4P0L	16.0		
	5P5L	24.0	3SUP-HQ50-ER-6	
	7P5L	33.0		
	011L	46.0		
	015L	61.0		
	018L	76.0		
	022L	88.0		
	030L	118.0		
	037L	146.0		
	045L	174.0		

*1 Data of Normal-Duty

*2 Top : Ferrite cores for input cable Bottom : Ferrite cores for output cable

Table 9-2-d Input filters for VT240S drives up to 055H

Series	Size	Output current (A) ^{*1}	Filter type	Ferrite core type ^{*2}
400V Series	0P7H	2.5	Built-in	ZCAT3035-1330x5(1)
	1P5H	3.6		
	2P2H	5.5		ZCAT3035-1330x5(1)
	4P0H	8.6		
	5P5H	13.0	3SUP-HB100-ER-6	
	7P5H	17.0		
	011H	23.0		
	015H	31.0		
	018H	37.0		
	022H	44.0		
	030H	60.0		
	037H	73.0		
	045H	87.0		
055H	108.0			

*1 Data of Normal-Duty

*2 Top : Ferrite cores for input cable Bottom : Ferrite cores for output cable

9. Compatible Standards

Table 9-2-e Input filters for VT240S drives In size 055L or larger

Series	Size	Output current (A)	Filter type	Ferrite core type ^{*1}
200V Heavy Duty	055L	174	3SUP-HK250-ER-6	
	075L	211	3SUP-HP500-ER-6	
	090L	286	3SUP-HP500-ER-6	
200V Normal Duty	055L	194	3SUP-HP500-ER-6	
	075L	270	3SUP-HP500-ER-6	
	090L	328	3SUP-HP500-ER-6	

*1 Under consideration

Table 9-2-f Input filters for VT240S drives In size 075H or larger

Series	Size	Output current (A)	Filter type	Ferrite core type ^{*1}
400V Heavy Duty	075H	108	3SUP-HK150-ER-6	
	090H	147	3SUP-HK200-ER-6	
	110H	179	3SUP-HK250-ER-6	
	132H	214	3SUP-HP500-ER-6	
	160H	249	3SUP-HP500-ER-6	
	200H	321	3SUP-HP500-ER-6	
	250H	428	3SUP-HP500-ER-6	
	315H	519	3SUP-HP700-ER-6	
	400H	590	3SUP-HP700-ER-6	
	475H	740	3SUP-HP700-ER-6 × 2	
400V Normal Duty	075H	147	3SUP-HK200-ER-6	
	090H	179	3SUP-HK250-ER-6	
	110H	214	3SUP-HP500-ER-6	
	132H	249	3SUP-HP500-ER-6	
	160H	293	3SUP-HP500-ER-6	
	200H	382	3SUP-HP500-ER-6	
	250H	479	3SUP-HP500-ER-6	
	315H	590	3SUP-HP700-ER-6	
	400H	740	3SUP-HP500-ER-6 × 2	
		475H	870	

*1 Under consideration

9-2-10-c Insulation test



If an insulation test is performed on a system incorporating VT240S and filters, do one of the following.

- Remove the input filters from the system during the test. (For precautions for the drive, see Chapter 2.)
- Perform the test at the maximum voltage of 1500VAC.

9-2-10-d Fitting ferrite cores

For VT240S in size 075H and larger, 055L and larger, Figs.9-2-e and 9-2-f (Under consideration) are examples where ferrite cores are fitted on the power cables and control leads. When using the filters listed in Tables 9-2-e, 9-2-f use the ferrite cores as listed for each drive. VT240S drives are designed to meet the EMC requirements with these ferrite cores properly fitted. Select the best suitable ferrite cores from the Figs. or equivalent. The ferrite cores should be closely to the drives as possible.

If VT240S is operated with Operation Panel using extension cable (See Table.9-2-g), fitting 2 ferrite cores (TDK: ZCAT1518-0730) on the cable is required.

Table.9-2-g Extension cable

Type	Length (m)
V23-W10-1	1
V23-W10-2	2
V23-W10-3	3

Appendix 1 Type Description System

■ Standard specifications

■ 200V Series VT240S-0P7L to 045L

Item		Specifications														
System		200V Series														
Type (VT240S-□□□□)		0P7L	1P5L	2P2L	4P0L	5P5L	7P5L	011L	015L	018L	022L	030L	037L	045L		
Inverter rating	Normal-duty	Rated capacity [kVA] (Note 1)	1.7	2.8	3.8	5.5	8.3	11	16	21	26	30	41	51	60	
		Max. continuous rated current [A] (Note 2)	5.0	8.0	11	16	24	33	46	61	76	88	118	146	174	
		Max. applicable motor [kW] (Note 3)	0.75	1.5	2.2	3.7	5.5	7.5	11	15	18.5	22	30	37	45	
		Carrier frequency (Note 4)	1 to 15kHz (Default : Soft sound 4kHz)													
		Overload current rating	120% for 1 min., 140% for 2.5 seconds													
	Heavy-duty	Rated capacity [kVA] (Note 1)	1.0	1.7	2.8	3.8	5.5	8.3	11	16	21	26	30	41	51	
		Max. continuous rated current [A] (Note 2)	3.0	5.0	8.0	11	16	24	33	46	61	76	88	118	146	
		Max. applicable motor [kW] (Note 3)	0.4	0.75	1.5	2.2	3.7	5.5	7.5	11	15	18.5	22	30	37	
		Carrier frequency (Note 4)	1 to 15kHz (Default : Soft sound 4kHz)													
		Overload current rating	150% for 1 min., 175% for 2.5 seconds													
Power supply	Rated input voltage: rated input frequency	200 to 240V ±10% 50 or 60Hz ±5%							200 to 230V ±10% 50 or 60Hz ±5%							
Output	Rated output voltage (Note 5) (Note 6)	200 to 240V (Max.)														
	Output frequency	0.1 to 440Hz														
Main circuit devices	EMC filter	Built-in (option)							Standalone (option)							
	DC reactor	Standalone (option)										Built-in (option)				
	Dynamic braking circuit	Built-in (standard)										Standalone (option)				
	Dynamic braking resistor	Built-in (option)							Standalone (option)							
Construction	Structure	Wall-mounted										Wall-mounted (standard) Free-standing type (option)				
	Enclosure	IP20										IP00 (standard) IP20 (option)				
	Cooling method	Self-cooling		Forced air cooling												
	Approx. weight (kg)	3					5			12		23		30		
	Paint color	Munsell N4.0														
Working environment	Indoors, Working ambient temperature: -10 to 50°C (Note 7) Relative humidity: 95%RH or below (no dew condensation), Altitude: 1000m or less, Vibration: 4.9m/s ² or less Freedom from corrosive or explosive gases, steam, dust, oil mist or cotton lint.															

Appendix

■ 400V Series VT240S-0P7H to 055H

Item		Specifications														
System		400V Series														
Type (VT240S-□□□□)		0P7H	1P5H	2P2H	4P0H	5P5H	7P5H	011H	015H	018H	022H	030H	037H	045H	055H	
Inverter rating	Normal-duty	Rated capacity [kVA] (Note 1)	1.7	2.5	3.8	6.0	9.0	12	16	21	26	30	42	51	60	75
		Max. continuous rated current [A] (Note 2)	2.5	3.6	5.5	8.6	13	17	23	31	37	44	60	73	87	108
		Max. applicable motor [kW] (Note 3)	0.75	1.5	2.2	3.7	5.5	7.5	11	15	18.5	22	30	37	45	55
		Carrier frequency (Note 4)	1 to 15kHz (Default : Soft sound 4kHz)													
		Overload current rating	120% for 1 min., 140% for 2.5 seconds													
	Heavy-duty	Rated capacity [kVA] (Note 1)	1.0	1.7	2.5	3.8	6.0	9.0	12	16	21	26	30	42	51	60
		Max. continuous rated current [A] (Note 2)	1.5	2.5	3.6	5.5	8.6	13	17	23	31	37	44	60	73	87
		Max. applicable motor [kW] (Note 3)	0.4	0.75	1.5	2.2	3.7	5.5	7.5	11	15	18.5	22	30	37	45
		Carrier frequency (Note 4)	1 to 15kHz (Default : Soft sound 4kHz)													
		Overload current rating	150% for 1 min., 175% for 2.5 seconds													
Power supply	Rated input voltage: rated input frequency	380 to 480V ±10% 50 or 60Hz ±5%														
Output	Rated output voltage (Note 5) (Note 6)	380 to 480V (Max.)														
	Output frequency	0.1 to 440Hz														
Main circuit devices	EMC filter	Built-in (option)											Standalone (option)			
	DC reactor	Standalone (option)											Built-in (option)			
	Dynamic braking circuit	Built-in (standard)										Standalone (option)				
	Dynamic braking resistor	Built-in (option)							Standalone (option)							
Construction	Structure	Wall-mounted											Wall-mounted (standard) Free-standing type (option)			
	Enclosure	IP20											IP00 (standard) IP20 (option)			
	Cooling method	Self-cooling		Forced air cooling												
	Approx. weight (kg)	3					5			12			23		27	
	Paint color	Munsell N4.0														
Working environment		Indoors, Working ambient temperature : -10 to 50°C (Note 7) Relative humidity: 95%RH or below (no dew condensation), Altitude: 1000m or less, Vibration: 4.9m/s ² or less Freedom from corrosive or explosive gases, steam, dust, oil mist or cotton lint.														

Appendix

■ 200V/400V Series VT240S-055L to 090L, -75H to 475H

Item		Specifications													
System		200V Series			400V Series										
Type (VT240S-□□□□)		055L	075L	090L	075H	090H	110H	132H	160H	200H	250H	315H	400H	475H	
Inverter rating	Normal-duty	Rated capacity [kVA] (Note 1)	73	99	114	102	124	148	173	222	297	360	409	513	603
		Max. continuous rated current [A] (Note 2)	211	286	328	147	179	214	249	321	428	519	590	740	870
		Max. applicable motor [kW] (Note 3)	55	75	90	75	90	110	132	160	200	250	315	400	475
		Carrier frequency (Note 4)	1 to 15kHz (Default : Soft sound 4kHz)												
		Overload current rating	120% for 1 min., 140% for 2.5 seconds												
	Heavy-duty	Rated capacity [kVA] (Note 1)	60	73	99	75	102	124	148	173	222	297	360	409	513
		Max. continuous rated current [A] (Note 2)	174	211	286	108	147	179	214	249	321	428	519	590	740
		Max. applicable motor [kW] (Note 3)	45	55	75	55	75	90	110	132	160	200	250	315	400
		Carrier frequency (Note 4)	1 to 15kHz (Default : Soft sound 4kHz)												
		Overload current rating	150% for 1 min., 175% for 2.5 seconds												
Power supply	Rated input voltage: rated input frequency	200 to 230V ±10% 50 or 60Hz ±5%			380 to 480V ±5% 50 or 60Hz ±5%										
Output	Rated output voltage (Note 5) (Note 6)	200 to 230V (Max.)			380 to 480V (Max.)										
	Output frequency	0.1 to 440Hz													
Main circuit devices	EMC filter	Standalone (option)													
	DC reactor	Built-in (option)						Standalone (option)							
	Dynamic braking circuit	Standalone (option)													
	Dynamic braking resistor	Standalone (option)													
Construction	Structure	Wall-mounted (standard), Free-standing type (option)													
	Enclosure	IP00 (standard), IP20 (option)													
	Cooling method	Forced air cooling													
	Approx. weight (kg)	45	(65)	(100)	42	45	(60)	(65)	(90)	(100)	(200)	285	290	295	
	Paint color	Munsell N4.0													
Working environment		Indoors, Working ambient temperature : -10 to 50°C (Note 7) Relative humidity: 95%RH or below (no dew condensation), Altitude: 1000m or less, Vibration: 4.9m/s ² or less Freedom from corrosive or explosive gases, steam, dust, oil mist or cotton lint.													

Appendix

(Note 1) The output voltage indicates the output capacity [kVA] at 200V for the 200V series, and 400V for the 400V series.

(Note 2) Indicates the total effective value including the higher harmonics. When using the normal-duty setting, the load rate must be limited to 80% to satisfy a life of five years at an annual average ambient temperature of 35°C.

(Note 3) Indicates the case for the MEIDENSHA standard 4-pole squirrel cage motor.

(Note 4) If 4kHz is exceeded when using the normal-duty setting, and if 4, 6, 8 or 10kHz is exceeded when using the heavy-duty setting, the maximum continuous rated current must be lowered.

• For 200V series, normal-duty setting

Capacity	4kH	6kHz	8kHz	10kHz	12kHz	15kHz	Derating
0P7L	5.0	4.7	4.4	4.1	3.9	3.6	4k to 10kHz: 3%/1kHz 10k to 15kHz: 2%/1kHz
1P5L	8.0	7.5	7.0	6.6	6.2	5.8	
2P2L	11.0	10.3	9.7	9.0	8.6	7.9	
4P0L	16.0	15.0	14.1	13.1	12.5	11.5	
5P5L	24.0	22.6	21.1	19.7	18.7	17.3	
7P5L	33.0	31.0	29.0	27.1	25.7	23.8	
011L	46.0	43.2	40.5	37.7	35.9	33.1	
015L	61.0	57.3	53.7	50.0	47.6	43.9	
018L	76.0	71.4	66.9	62.3	59.3	54.7	
022L	88.0	82.7	77.4	72.2	66.9	59.0	
030L	118.0	110.9	103.8	96.8	89.7	79.1	3%/1kHz
037L	146.0	137.2	128.5	119.7	111.0	97.8	
045L	174.0	163.6	153.1	142.7	132.2	116.6	

• For 400V series, normal-duty setting

Capacity	4kH	6kHz	8kHz	10kHz	12kHz	15kHz	Derating
0P7H	2.5	2.3	2.0	1.8	1.6	1.4	4k to 10kHz: 5%/1kHz 10k to 15kHz: 3%/1kHz
1P5H	3.6	3.2	2.9	2.5	2.3	2.0	
2P2H	5.5	5.0	4.4	3.9	3.5	3.0	
4P0H	8.6	7.7	6.9	6.0	5.5	4.7	
5P5H	13.0	11.7	10.4	9.1	8.3	7.2	
7P5H	17.0	15.3	13.6	11.9	10.9	9.4	
011H	23.0	20.7	18.4	16.1	14.7	12.7	
015H	31.0	27.9	24.8	21.7	19.8	17.1	
018H	37.0	33.3	29.6	25.9	23.7	20.4	
022H	44.0	39.6	35.2	30.8	28.2	24.2	
030H	60.0	54.0	48.0	42.0	36.0	27.0	5%/1kHz
037H	73.0	65.7	58.4	51.1	43.8	32.9	
045H	87.0	78.3	69.6	60.9	52.2	39.2	
055H	108.0	97.2	86.4	75.6	64.8	48.6	

• For 200V series, heavy-duty setting

Capacity	4kH	6kHz	8kHz	10kHz	12kHz	15kHz	Derating
0P7L	→	→	→	3.0	2.9	2.7	10k to 15kHz: 2%/1kHz
1P5L	→	→	→	5.0	4.8	4.5	
2P2L	→	→	→	8.0	7.7	7.2	
4P0L	→	→	→	11.0	10.6	9.9	
5P5L	→	→	→	16.0	15.4	14.4	
7P5L	→	→	→	24.0	23.0	21.6	
011L	→	→	→	33.0	31.7	29.7	
015L	→	→	46.0	43.2	39.8	37.2	8k to 10kHz: 3%/1kHz 10k to 15kHz: 2%/1kHz
018L	→	→	61.0	57.3	52.8	49.3	
022L	→	76.0	71.4	69.2	66.9	58.8	6k to 10kHz: 3%/1kHz 10k to 15kHz: 2%/1kHz
030L	→	88.0	82.7	80.1	77.4	68.1	
037L	118.0	110.9	97.6	80.0	89.7	79.1	3%/1kHz
045L	146.0	137.2	120.8	99.0	111.0	97.8	

• For 400V series, heavy-duty setting

Capacity	4kHz	6kHz	8kHz	10kHz	12kHz	15kHz	Derating
0P7H	→	→	→	1.5	1.4	1.3	10k to 15kHz: 3%/1kHz
1P5H	→	→	→	2.5	2.4	2.1	
2P2H	→	→	→	3.6	3.4	3.1	
4P0H	→	→	→	5.5	5.2	4.7	
5P5H	→	→	→	8.6	8.1	7.3	
7P5H	→	→	→	13.0	12.2	11.1	
011H	→	→	→	17.0	16.0	14.5	
015H	→	→	23.0	20.7	19.3	17.3	8k to 10kHz: 5%/1kHz 10k to 15kHz: 3%/1kHz
018H	→	→	31.0	27.9	26.0	23.3	
022H	→	→	37.0	33.3	31.1	27.8	8k to 15kHz: 3%/1kHz
030H	→	→	44.0	39.6	35.2	28.6	
037H	→	60.0	54.0	48.0	42.0	33.0	6k to 15kHz: 5%/1kHz
045H	→	73.0	65.7	58.4	51.1	40.2	
055H	87.0	78.3	69.6	60.9	52.2	39.2	

The carrier frequency automatic reduction function may automatically reduce the carrier frequency to 2.0kHz depending on the output current or inverter temperature. This function is valid only when C22-6 is set to 1. The reduction function is enabled as the factory setting. The setting value and actual carrier frequency may differ, so check the actual carrier frequency with D03-3. The reduction conditions for each capacity are shown below.

- For 0P7H to 5P5H, 0P7L to 5P5L
If the power module temperature exceeds 110°C, the carrier frequency is automatically reduced to 2.0kHz.
- For 7P5H to 022H, 7P5L, 011L
If the power module temperature exceeds 85°C, the carrier frequency is automatically reduced to 2.0kHz.
- For 030H or more, 015L or more
If the heat sink temperature 75°C is exceeded and the output current exceeds 110% or if the heat sink temperature 95°C is exceeded, the carrier frequency will automatically change to 2.0kHz.

* Check the power module and heat sink temperature with D02-4.

(Note 5) An output voltage exceeding the input voltage cannot be attained.

(The upper limit of the output voltage effective value is the DC voltage/1.37.)

(Note 6) The rated output voltage for the sensor-less vector control mode, vector control with sensor mode, PM control with sensor mode and the sensor-less PM control mode is as follows.

200V series : 160V/180V/190V respectively in respect to input voltage 200V/220V/240V

400V series : 300V/320V/360V/380V respectively in respect to input voltage

380V/400V/440V/480V

Appendix

(Note 7) The following conditions apply to the upper limit of the working ambient temperature when using the normal-duty setting.

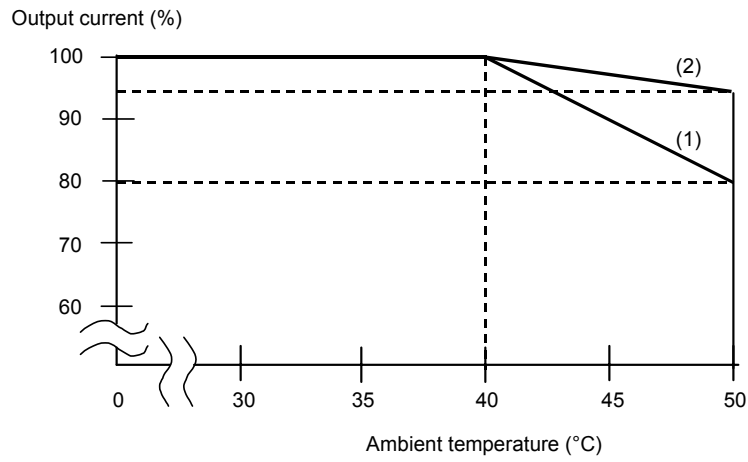

(1) 5P5L

If the ambient temperature exceeds 40°C, reduce the output current by 2% per 1°C.

(2) 011L/5P5H (NF)/015H

If the ambient temperature exceeds 40°C, reduce the output current by 0.5% per 1°C.

Appendix

■ Control specifications table

		V/f control	Speed sensor-less vector control	Vector control with speed sensor (Note 1)	PM motor control with sensor (Note 2)	Sensor-less PM motor control (Note 4)
Frequency control	Control method	All digital control Sine wave approximation PWM				
	Transfer frequency	Mono-sound mode : 1 to 15kHz (0.1kHz increments) Soft sound mode : Average frequency 2.1 to 5kHz Frequency modulation method (3 tone modulation, 4 tone modulation)				
	Output frequency resolution	0.01Hz				
	Frequency setting resolution	0.01Hz (digital) 0.025% (analog) In respect to maximum frequency				
	Frequency accuracy	±0.01% (digital) at 25±10°C ±0.0% (analog) at 25±10°C				
Control specifications	Voltage/frequency characteristics	Middle V/f point of five points randomly set between 3 and 440Hz can be set	Randomly set between 150 and 9999min ⁻¹ (max. 180Hz)		Randomly set between 150 and 9999min ⁻¹ (max. 210Hz)	Currently being reviewed
	Torque boost	Manual/automatic selective	-			
	Max. torque boost	Max. torque for applicable motor is output when used with automatic tuning.	-			
	Automatic tuning	Automatic measurement of motor constants Automatic measurement of various parameters Basic method which does not rotate motor, and extended method which rotates motor are available			Encode phase adjustment Magnetic pole position estimation	Currently being reviewed
	Starting frequency	Set between 0.1 and 60.0Hz	-			Currently being reviewed
	Starting torque	200% or more (Note 3) • Using Meidensha standard motor • At 150% of rated current • Attainment time approx. 3 sec.	-			Approx. 80% Details are currently being reviewed
	Acceleration/ deceleration time	0.01 to 60000sec Acceleration/deceleration time × 2, jogging dedicated × 1, program cushion × 8				
	Acceleration/ deceleration mode	Linear/S-character selective				
Operation method	3 modes selective • Forward run/reverse run • Run stop/forward run reverse run • Forward run pulse/reverse run pulse/stop					

(Note 1) The IM speed detection option PCB is required.

(Note 2) This is for the Meidensha standard PM motor. The PM speed detection option PCB is required.

(Note 3) Differs according to the motor capacity, rated voltage and rated frequency. If 45kW is exceeded, starting torque is approx. 150%.

(Note 4) The specifications for the sensor-less PM motor control are currently being reviewed. The inverter and motor combination must be adjusted, and as this is not a universal combination, the applications and users will be limited. Contact Meidensha for more details.

Appendix

■ Control specifications table (continued)

		V/f control	Speed sensor-less vector control	Vector control with speed sensor (Note 1)	PM motor control with sensor (Note 2)	Sensor-less PM motor control (Note 4)	
Control specifications	Stop method	Deceleration stop in respect to run, emergency stop and inching, coast to stop selective					
	DC braking	Braking start frequency, randomly set between 0.1 and 60.0Hz Braking voltage, randomly set between 0.1 and 20.0%	Braking start speed, randomly set between 0.00 and 50.00% Braking current, randomly set between 50 and 150%.				
		Braking time	Randomly set between 0.0 and 20.0 seconds				
	Output frequency	0 to 440Hz	0 to 180Hz		0 to 210Hz	0 to 440Hz	
	Speed control	Control range	Simple ASR function is not specified	1 : 100	1 : 1000	1 : 100	Currently being reviewed
		Constant output range	Up to 1 : 7	Up to 1 : 2	Up to 1 : 4	Up to 1 : 1.5	
		Control accuracy (At Fmax ≥ 50Hz)	±0.01%	±0.5%	±0.01%	±0.01%	
		Control response	Simple ASR function is not specified	5Hz	30Hz	—	
	Setting	Multi-step frequency setting	8 steps Acceleration/deceleration time as changeable 5-bit non-encode mode				
		Ratio interlock setting	During remote setting mode $y = Ax + B + C$ y: Operation results x: Operation input A: 0.000 to ±10.000 B: 0.00 to ±440.00Hz C: Auxiliary input With output upper/lower limit	During remote setting mode $y = Ax + B + C$ y: Operation results x: Operation input A: 0.000 to ±10.000 B: 0 to ±9999min ⁻¹ C: Auxiliary input With output upper/lower limit			
Frequency jump		Three places can be set Width can be varied between 0.0 and 10Hz	—				
Slip compensation		Operation/non selective Slip compensation gain: 0.0 to 20.0	—				
Automatic run function		10-step automatic run function Synchronous/asynchronous selective					
Built-in PLC function		Arithmetic operations, logical operations, size comparison and LPF operations, etc., in respect to the sequence input/output and analog input/output are possible. Program capacity: max. 64 commands * 5 banks, operation cycle: 1 bank in 2ms					
Others		PID control Pick-up Automatic start Restart after instantaneous power failure Reverse run prevention Traverse pattern	Deceleration control at power failure Multi-pump Spinning frame				
Control input/output	Operation panel	Local/remote changeover operation, forward run/reverse run direct operation, reference, change and copy of all parameters Mountable outside unit (extension cable max. 3m)					
	LCD type	Display : 16 characters * 2 lines Status display LED: 4 points Operation : Operate with knob and set key					
		LED type					
	Sequence input	Programmable : 7 points sink/source changeable, PSI7 is used as pulse train input					

Appendix

■ Control specifications table (continued)

		V/f control	Speed sensor-less vector control	Vector control with speed sensor (Note 1)	PM motor control with sensor (Note 2)	Sensor-less PM motor control (Note 4)
Control input/output	Sequence output	Relay 1c contact: 1 point (programmable), relay 1a contact: 1 point (programmable), open collector: 3 points (programmable), PS03 is used as pulse train output The programmable details can be changed between speed detection, pre-charging complete, reverse run, speed reached, direction operation, current reached, speed reached, acceleration, deceleration and fault code				
	Frequency setting	Voltage input (0 to 10V, 0 to 5V, 1 to 5V) or current input (4 to 20mA, 0 to 20mA): 2 points Voltage input (0 to ±10V, 0 to ±5V, 1 to 5V): 1 point (used with sequential ratio operation or PID feedback, etc.) Pulse train input (max. 10kHz): 1 point				
Control	Meter output	Voltage output (0 to 10V) or current output (4 to 20mA): 2 points (programmable) Change between output frequency, output voltage, output current, DC voltage, etc.				
Communication	Serial interface	Communication protocol: Modbus-RTU or VT240S series dedicated communication (standard serial) Connection method: RS485, 2-wire type, Transmission distance: total extension distance 150m or less, Transmission method: Start-stop synchronization, half-duplex communication, Baud rate: select from 4800/9600/14400/19200/38400bps, No. of stations: max. 32 units, Error detection: Sum check, parity, framing				
Protection	Preventive	Overcurrent limit (primary current limit level changeable in three stages), overcurrent limit, undervoltage limit, overload warning, carrier frequency automatic reduction at overload (cooling fin overheat) (selective)				
	Shut-off	Overcurrent, overvoltage, undervoltage, IGBT fault, phase failure (input/output), overload, cooling fin temperature rise, ground fault, other self-diagnosis				
	Fault history	Past four faults recorded. Recorded details: primary cause, secondary cause, output frequency/current/DC voltage before shutoff, hardware latch, cumulative ON time, cumulative operation time				
	Overload withstand level	Normal-duty setting 120% for 1 minute, 140% for 2.5 seconds (reduced to 60% for 1 minute from 1Hz to 0.1Hz), inverse time characteristics Heavy-duty setting 150% for 1 minute, 175% for 2.5 seconds (reduced to 75% for 1minute from 1Hz to 0.1Hz), inverse time characteristics				
	Retry	Randomly set between 0 and 10 times				

Appendix 2 Outline Dimension Drawings

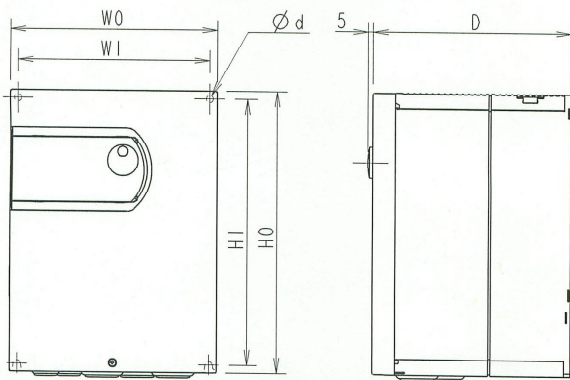

Fig. 1

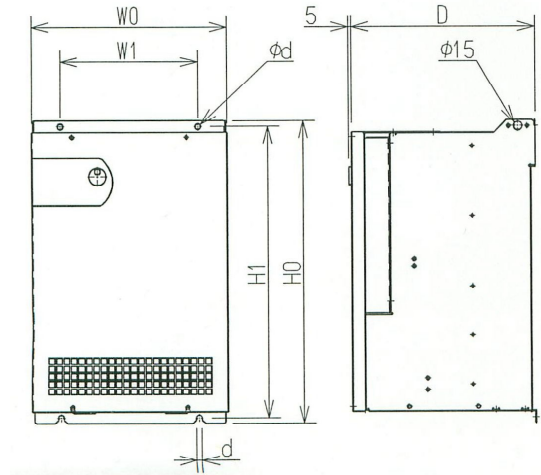

Fig. 2

■ 200V Series VT240S-0P7L to 045L, 400V Series VT240S-0P7H to 055H

Type		Dimensions (mm)						Main circuit terminal	Weight (kg)	Fig.
200V Series	400V Series	W0	W1	H0	H1	D	ϕd			
0P7L 1P5L 2P2L 4P0L 5P5L	0P7H 1P5H 2P2H 4P0H 5P5H	155	140	250	235	180	6	M4	3	1
	7P5H 011H									
7P5L 011L	015H	205	190	275	260	196	7	M5	5	
	018H 022H									
015L 018L	030H	260	240	350	330	298		M6	12	
022L 030L	037H 045H									
	055H	300	200	470	450	317	10	M8	23	
				520	500				27	
037L 045L		340	240					M10	30	2

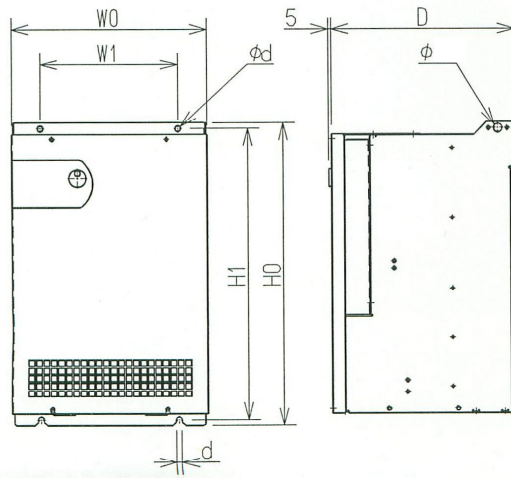

Fig. 3

■ 200V Series VT240S-055L to 090L, 400V Series VT240S-075H to 475H

Type		Dimensions (mm)						Main circuit terminal	Weight (kg)	Fig.
200V Series	400V Series	W0	W1	H0	H1	D	ød			
055L	075H 090H	430	300	615	595	350	10	M10	42	3
									45	
075L	110H 132H	500	400	740	714	350	10		(60)	
									(65)	
090L	160H 200H	580	400	1020	990	350	10		(90)	
									(100)	
	250H 315H 400H 475H	580	400	1300	1270	470	15	M16	(200)	
									285	
									290	
									295	

Appendix 3. Fault Codes

Code	Display	Fault	Description	Retry
00	0000	No fault	No fault recorded.	×
01	EEA (EMS)	Emergency stop	Indicates that sequence signal EMS has been input in C00-4 = 2 (fault output at emergency stop) mode.	×
02	Pa-n (PM-n)	Power module error	Power module fault n: sub-code 1: during stop 2: during operation at the set speed 3: during acceleration 4: during deceleration 5: during braking 6: during ACR 7: during excitation 9: during automatic tuning	○
03	OC-n (OC-n)	Over current	The output has risen to or beyond 300%. n: sub-code 1: during stop 2: during operation at the set speed 3: during acceleration 4: during deceleration 5: during braking 6: during ACR 7: during excitation 9: during automatic tuning	○
04	OV-n (OV-n)	Over voltage	The DC voltage has risen to or beyond the preset level. (Vdc ≥ 800 or 400V) n: sub-code 1: during stop 2: during operation at the set speed 3: during acceleration 4: during deceleration 5: during braking 6: during ACR 7: during excitation 9: during automatic tuning	○
05	UV-n (UV-n)	Under voltage	While the drive is running, the DC voltage has lowered to or beyond the preset level (65% of the rating). n: sub-code 1: during stop 2: during operation at the set speed 3: during acceleration 4: during deceleration 5: during braking 6: during ACR 7: during excitation 9: during automatic tuning When C08-0=2, 3 (automatic start), only the symbol is displayed, and the FLT LED does not operate.	×
06	PHL-n (PHL-n)	Phase failure	This indicates that there is a phase failure in the AC input power supply. n: sub-code 1: Input phase failure 2: Output phase failure	×
07	UOH-n (UOH-n)	Overheat	The heatsink temperature has risen. n: sub-code 1: Detected with thermistor 2: Detected with thermostat	○
08	SP-n (SP-n)	Speed error	This indicates that the motor rotation speed is abnormal. n: sub-code 1: Overspeed (C24-0 over) 2: Speed (magnetic pole position) detection error (C24-2) 3: Speed deviation error (C24-5) 4: Reverse run detection error 5: Encoder initialization error 1 6: Encoder initialization error 2	×
09	CONV (CONV.)	Converter fan fault	This indicates that trouble has occurred in the converter cooling fan. (Only on parallel machines mounted with a converter fan.) (Note 1)	○
0A	Att-n (ATT-n)	Automatic tuning abnormal completion	This indicates that the automatic tuning did not complete normally. n: sub-code (Automatic tuning step) 1: Setting error 2: Calculation operation error 3: Operation error 4: Load error 5: End process error 6: Convergence operation error 7: Magnetic pole position estimation motor rotation error 8: Magnetic pole position estimation voltage stability error 9: Magnetic pole position estimation retry error	×
0B	OL-n (OL-n)	Overload	Indicate that the output current exceeded the thermal operation time having inverse time characteristics. When Normal-duty is set, the standard characteristics are 120% for one minute in respect to the motor rated current value. At 122% or more in respect to the inverter rated current, this will be 140% for 2.5 seconds. When Heavy-duty is set, the standard is 150% for one minute in respect to the motor rated current value. At 155% or more in respect to the inverter rated current, this will be 175% for 2.5 seconds. n: sub-code 1: Equipment overload 2: DBR overload 3: Motor overload	○

Appendix

Code	Display	Fault	Description	Retry
0C	0Fdn (GRD. n)	Ground	The Drive has sensed grounded conditions on the output. n: sub-code 1: during stop 2: during operation at the set speed 3: during acceleration 4: during deceleration 5: during braking 6: during ACR 7: during excitation 9: during automatic tuning	○
0D	Bo-n (IO-n.)	I/O error	There has been an error in communications through the I/O port. n: sub-code 1: Gate shutdown circuit error. A feedback signal has disagreed to a gate shutdown command. 2: A/D convertor error. The A/D convertor has been jammed. 3: Current detector offset. The offset of the current detector has increased to or beyond 0.5V. 4: Retry time out. Indicates that the operation was not successful within the No. of retries set in C21-0. 7: This indicates that the PROFIBUS interface option cannot be started up. 8: This indicates that a watch dog error occurred in the PROFIBUS interface option. Indicates that an operation delay occurred in the PROFIBUS interface option. B: PID error C: External brake IDET error D: External brake RUN error E: External brake answer error F: Thermistor fault	×
0E	CPUn (CPU. n)	CPU error	There has been an error while the CPU, RAM or ROM is in the self-diagnosis mode at power-up. n: sub-code 1: Watch-dog error, indicating that the CPU has been jammed. This fault may appear during at-speed operation. 2: CPU calculation error. 3: CPU RAM error. 4: External RAM error. 6: E ² PROM check-sum error. 7: E ² PROM read error. 8: E ² PROM write error. This error is only displayed, and the gate will not shut down and FLT will not be output. A: Stack overflow B: Simple PLC overload * CPU1 to 6, 7 and 8 are specific fault output functions and cannot be output.	×
0F	FUSE (FUSE)	Fuse blown	Indicate that the main circuit's fuse has blown.	○
10	BPFLT (BPFLT)	Parallel unit signal cutoff	Indicates that the connection signal with the parallel unit has been cut off.	○
-	dEr (dEr)	E ² PROM data error	Indicates that there is an error in the various data stored in the E ² PROM. For details, enter the monitor mode: D20-2, and correct the data. Caution If this appears when starting up, the details will not be stored internally. Thus, after starting up normally, these details cannot be read with the fault history (D20-0).	×

Appendix 4. Display Messages

Display	Name	Explanation
88FF	OFF	<ul style="list-style-type: none"> Indicates that the motor is stopped.
88UN	RUN	<ul style="list-style-type: none"> Indicates that the motor is running. Occurs when a parameter, which cannot be changed during operation, was changed during operation.
88LL	LOCK	<ul style="list-style-type: none"> Indicates that the parameters are locked. Occurs when a parameter locked with C09-0 was operated. Also occurs when a key other than the STOP key was pressed while key operations were prohibited with C09-1.
88RY	RETRY	<ul style="list-style-type: none"> Indicates that the operation is being retried. The value displayed at the same time is the number of retries.
88BR	BREAK	<ul style="list-style-type: none"> Indicates that the brakes are being applied.
88PU	Pick Up	<ul style="list-style-type: none"> Indicates that pick-up is being applied.
88ER	Over	<ul style="list-style-type: none"> Indicates that the scale display has exceeded the upper limit 99999.
88EE	EEPROM Error	<ul style="list-style-type: none"> Indicates that an error occurred during the parameter copy function's verify check using the operation panel.
88FF	ERROR	<ul style="list-style-type: none"> Indicates that the fault display mode is active.
88EF	Minor Error	<ul style="list-style-type: none"> Indicates that the minor fault display mode is active.
88LE	LIST	<ul style="list-style-type: none"> Indicates that the list display mode is active.
88ST	Auto Tuning Start	<ul style="list-style-type: none"> Indicates that automatic tuning will be started.
88ED	Auto Tuning End	<ul style="list-style-type: none"> Indicates that automatic tuning has ended.
88ER	Data ERROR	
88CH	Data CHANGE	<ul style="list-style-type: none"> Indicates the head of the list display.
88ED	Data END	<ul style="list-style-type: none"> Indicates the end of the list display.

Appendix 5. Segment LED Display

(1) Numeric

Display	0	1	2	3	4	5	6	7	8	9
Numerics	0	1	2	3	4	5	6	7	8	9

(2) Alphabet

Display	A	b	C	d	E	F	G	H	I	J
Alphabet	A	B (b)	C	D (d)	E	F	G	H	I	J

Display	L	m	n	O	P	q	R (r)	S	T (t)	U
Alphabet	L	M (m)	N (n)	O	P	Q (q)	R (r)	S	T (t)	U

Display	v	Y	-	[]
Alphabet	V (v)	Y	-	(Brackets)

Revision history

Revision history				
Revision	Page	Revision details	CPU version	ROM version
-	-		9457.0	9458.0

Main Products

Power Generating Systems
Substation Systems
Power Transmission and Distribution Protection System
Building Administration System
Railway System
Road Supervisory System
Water Treatment System
Industrial Process and Control System
Variable-Speed Control System
Induction Heating System
Dynamometer Applied System
Logistics System
Wholesale-Flowermarket Information System
Plant Construction

Generators
Compact Substation Equipment
Transformers
Circuit-Breakers
Switchgears
Surge Arresters
Static Power Inverters and Converters
Electric Motors
Motor Speed Control Equipment
Programmable Controller
Palletizing Equipment
Unattended Carriers
Computers

MEIDENSHA CORPORATION

Riverside Building, 36-2, Nihonbashi Hakozaicho, Chuo-ku, Tokyo 103-8515 Japan
Phone: Tokyo 3-5641-7229 Facsimile: 3-5641-7249

Overseas Offices & Group Companies

China

DONGGUAN MEIDEN ELECTRICAL ENGINEERING CO., LTD.
Yan Wu Industrial District,
Wan Jiang Country, Dongguan,
Guangdong 523049
P.R. China
Phone: 769-22171273
Facsimile: 769-2285210

SHANGHAI MEIDEN SEMICONDUCTOR CO., LTD.
53-1A, No.311, Fu Te Nan Lu,
Wai Gao Qiao Free Trade Zone,
Shanghai 200137,
P.R.China
Phone: 21-50483681
Facsimile: 21-50483035

MEIDEN ZHENGZHOU ELECTRIC CO.,LTD.
No.87 Hehuan Street,
Zhengzhou Hi-Tech Industries
Development Zone,
Zhengzhou, Henan Province,
P.C.450001, P.R.China
Phone: 371-67848-800
Facsimile: 371-67848-797

Hong Kong

MEIDEN PACIFIC (CHINA) LTD.
Unit 01-02A, 16/F, Tower 1,
Ever Gain Plaza,
88 Container Port Road,
Kwai Chung, N.T., Hong Kong
Phone: 2503-2468
Facsimile: 2887-8046

Indonesia

P.T. MEIDEN ENGINEERING INDONESIA
20th Floor, Summitmas I,
Jl. Jenderal Sudirman Kaveling 61-62
P.O.BOX 6920/KBY/Summitmas I
Jakarta Selatan 12190, Indonesia
Phone: 21-520-0612
Facsimile: 21-520-0240

Korea

MEIDENSHA CORPORATION
Royal Building No. 410,
5 Dangju-Dong,
Chongro-ku, Seoul, Korea
Phone: 2-736-0232~3
Facsimile: 2-736-0234

Malaysia

MEIDEN ELECTRIC ENGINEERING SDN. BHD.
G.03, Ground Floor, Wisma Academy,
4A, Jalan 19/1,
46300 Petaling Jaya,
Selangor Darul Ehsan, Malaysia
Phone: 3-79554646
Facsimile: 3-79546466

Singapore

MEIDEN ASIA PTE. LTD.
5, Jalan Pesawat,
Jurong Industrial Estate,
Singapore 619363
Phone: 6268-8222
Facsimile: 6264-4292

MEIDEN SINGAPORE PTE. LTD.
5, Jalan Pesawat,
Jurong Industrial Estate,
Singapore 619363
Phone: 6268-8222
Facsimile: 6264-4292

MEIDEN POWER SOLUTIONS (SINGAPORE) PTE. LTD.
No.14 Penjuru Close
Singapore 608610
Phone: 6377-5387
Facsimile: 6377-5386

Thailand

THAI MEIDENSHA CO., LTD.
11th Floor, TST Tower Building,
21 Vipavadi-Rangsit Road,
Soi Chuei Phung, Jomphol, Jatujak,
Bangkok 10900, Thailand
Phone: 2-273-8954~61
Facsimile: 2-273-8966

MEIDEN ELECTRIC (THAILAND) LTD.
898 Moo 2,
Bangpa-in Industrial Estate,
Udomsoraryuth Rd.,
Klongjig, Bangpa-in,
Ayudhaya 13160, Thailand
Phone: 35-258258~262
Facsimile: 35-221388

The United Kingdom

MEIDEN EUROPE LTD.
NYK Complex,
Bradbourne Drive,
Tilbrook,
Milton Keynes MK7 8BN,
England, U.K.
Phone: 1908-276000
Facsimile: 1908-276010

The United States

MEIDEN AMERICA, INC.
27000 Meadowbrook Road,
Meadowbrook Corporate Park,
Suite #209,
Novi, Michigan 48377,
U.S.A.
Phone: 248-305-9903
Facsimile: 248-305-9904